

# Or1ksim: The OpenRISC 1000 Architectural Simulator

Generated by Doxygen 1.5.7.1

Tue Feb 24 14:24:06 2009



# Contents

<b>1</b>	<b>Or1ksim: the OpenRISC 1000 Architectural Simulator</b>	<b>1</b>
1.1	About . . . . .	1
1.2	Installation . . . . .	1
1.3	Documentation . . . . .	1
1.4	Copying . . . . .	1
<b>2</b>	<b>Todo List</b>	<b>3</b>
<b>3</b>	<b>Data Structure Index</b>	<b>5</b>
3.1	Data Structures . . . . .	5
<b>4</b>	<b>File Index</b>	<b>9</b>
4.1	File List . . . . .	9
<b>5</b>	<b>Data Structure Documentation</b>	<b>13</b>
5.1	_csm_list Struct Reference . . . . .	13
5.1.1	Field Documentation . . . . .	14
5.1.1.1	cmatch . . . . .	14
5.1.1.2	cmovs . . . . .	14
5.1.1.3	cnt . . . . .	14
5.1.1.4	dead . . . . .	14
5.1.1.5	from . . . . .	14
5.1.1.6	next . . . . .	14
5.1.1.7	ninsn . . . . .	14
5.1.1.8	osize . . . . .	14
5.1.1.9	ref . . . . .	14
5.1.1.10	size . . . . .	14
5.2	_cuc_func Struct Reference . . . . .	15
5.2.1	Field Documentation . . . . .	16
5.2.1.1	bb . . . . .	16

5.2.1.2	end_addr	16
5.2.1.3	fdeps	16
5.2.1.4	init_bb_reloc	16
5.2.1.5	lur	16
5.2.1.6	memory_order	16
5.2.1.7	msched	16
5.2.1.8	mtype	16
5.2.1.9	nfdeps	16
5.2.1.10	nmsched	16
5.2.1.11	num_bb	16
5.2.1.12	num_init_bb	16
5.2.1.13	num_runs	16
5.2.1.14	orig_time	16
5.2.1.15	saved_regs	16
5.2.1.16	start_addr	16
5.2.1.17	timings	16
5.2.1.18	tmp	16
5.2.1.19	used_regs	16
5.3	_dep_list_t Struct Reference	17
5.3.1	Field Documentation	17
5.3.1.1	next	17
5.3.1.2	ref	17
5.4	archf Struct Reference	18
5.4.1	Field Documentation	18
5.4.1.1	gen_func_reloc	18
5.4.1.2	gen_reloc	18
5.4.1.3	get_real_func_len	18
5.5	ata_device Struct Reference	19
5.5.1	Field Documentation	22
5.5.1.1	command	22
5.5.1.2	conf	22
5.5.1.3	cylinder_high	22
5.5.1.4	cylinder_low	22
5.5.1.5	daspi	22
5.5.1.6	daspo	22
5.5.1.7	dataport_i	22

---

5.5.1.8	dbuf	22
5.5.1.9	dbuf_cnt	22
5.5.1.10	dbuf_ptr	22
5.5.1.11	dev	22
5.5.1.12	device_control	22
5.5.1.13	device_head	22
5.5.1.14	dma_mode	22
5.5.1.15	dmarq	22
5.5.1.16	end_t_func	22
5.5.1.17	error	22
5.5.1.18	features	22
5.5.1.19	file	22
5.5.1.20	firmware	22
5.5.1.21	heads	22
5.5.1.22	heads_per_cylinder	22
5.5.1.23	host	22
5.5.1.24	internals	22
5.5.1.25	intrq	22
5.5.1.26	iordy	22
5.5.1.27	lba	22
5.5.1.28	mwdma	22
5.5.1.29	nr_sect	22
5.5.1.30	packet	22
5.5.1.31	pdiagi	22
5.5.1.32	pdiago	22
5.5.1.33	pio	22
5.5.1.34	pio_mode	22
5.5.1.35	regs	22
5.5.1.36	sector_count	22
5.5.1.37	sector_number	22
5.5.1.38	sectors	22
5.5.1.39	sectors_per_track	22
5.5.1.40	sigs	22
5.5.1.41	size	22
5.5.1.42	size_sect	22
5.5.1.43	state	22

5.5.1.44	status	22
5.5.1.45	stream	22
5.5.1.46	type	22
5.6	ata_devices Struct Reference	24
5.6.1	Field Documentation	24
5.6.1.1	device	24
5.7	ata_host Struct Reference	25
5.7.1	Field Documentation	26
5.7.1.1	baseaddr	26
5.7.1.2	ctrl	26
5.7.1.3	dev_id	26
5.7.1.4	dev_sel	26
5.7.1.5	devices	26
5.7.1.6	dma_mode0_td	26
5.7.1.7	dma_mode0_tioc	26
5.7.1.8	dma_mode0_tm	26
5.7.1.9	dtr0	26
5.7.1.10	dtr1	26
5.7.1.11	enabled	26
5.7.1.12	irq	26
5.7.1.13	mem	26
5.7.1.14	pctr	26
5.7.1.15	pptr0	26
5.7.1.16	pptr1	26
5.7.1.17	pio_mode0_t1	26
5.7.1.18	pio_mode0_t2	26
5.7.1.19	pio_mode0_t4	26
5.7.1.20	pio_mode0_tioc	26
5.7.1.21	regs	26
5.7.1.22	rev	26
5.7.1.23	rxb	26
5.7.1.24	stat	26
5.7.1.25	txb	26
5.8	bff Struct Reference	28
5.8.1	Field Documentation	28
5.8.1.1	close_obj	28

---

5.8.1.2	get_func_len	28
5.8.1.3	get_func_name	28
5.8.1.4	get_func_reloc	28
5.8.1.5	get_func_start	28
5.8.1.6	open_obj	28
5.9	BMP_HEADER Struct Reference	29
5.9.1	Field Documentation	29
5.9.1.1	offset	29
5.9.1.2	reserved1	29
5.9.1.3	reserved2	29
5.9.1.4	size	29
5.9.1.5	type	29
5.10	bpb_entry Struct Reference	30
5.10.1	Field Documentation	30
5.10.1.1	addr	30
5.10.1.2	lru	30
5.10.1.3	taken	30
5.10.1.4	way	30
5.11	bpbstat Struct Reference	31
5.11.1	Field Documentation	31
5.11.1.1	correct	31
5.11.1.2	hit	31
5.11.1.3	incorrect	31
5.11.1.4	miss	31
5.12	branchstat Struct Reference	32
5.12.1	Field Documentation	32
5.12.1.1	backward	32
5.12.1.2	forward	32
5.12.1.3	nottaken	32
5.12.1.4	taken	32
5.13	breakpoint_entry Struct Reference	33
5.13.1	Detailed Description	33
5.13.2	Field Documentation	33
5.13.2.1	addr	33
5.13.2.2	next	33
5.14	btic_entry Struct Reference	34

5.14.1	Field Documentation	34
5.14.1.1	addr	34
5.14.1.2	insn	34
5.14.1.3	lru	34
5.14.1.4	way	34
5.15	bticstat Struct Reference	35
5.15.1	Field Documentation	35
5.15.1.1	hit	35
5.15.1.2	miss	35
5.16	cachestats_entry Struct Reference	36
5.16.1	Field Documentation	36
5.16.1.1	readhit	36
5.16.1.2	readmiss	36
5.16.1.3	writehit	36
5.16.1.4	writemiss	36
5.17	channel Struct Reference	37
5.17.1	Detailed Description	37
5.17.2	Field Documentation	37
5.17.2.1	data	37
5.17.2.2	ops	37
5.18	channel_factory Struct Reference	38
5.18.1	Field Documentation	38
5.18.1.1	name	38
5.18.1.2	next	38
5.18.1.3	ops	38
5.19	channel_ops Struct Reference	39
5.19.1	Detailed Description	39
5.19.2	Field Documentation	39
5.19.2.1	close	39
5.19.2.2	free	39
5.19.2.3	init	39
5.19.2.4	isok	39
5.19.2.5	open	39
5.19.2.6	read	39
5.19.2.7	status	39
5.19.2.8	write	39



---

5.20 COFF_AOUTHDR Struct Reference . . . . .	40
5.20.1 Field Documentation . . . . .	40
5.20.1.1 bsize . . . . .	40
5.20.1.2 data_start . . . . .	40
5.20.1.3 dsize . . . . .	40
5.20.1.4 entry . . . . .	40
5.20.1.5 magic . . . . .	40
5.20.1.6 text_start . . . . .	40
5.20.1.7 tsize . . . . .	40
5.20.1.8 vstamp . . . . .	40
5.21 COFF_auxent Union Reference . . . . .	41
5.21.1 Field Documentation . . . . .	43
5.21.1.1 x_ary . . . . .	43
5.21.1.2 x_dimen . . . . .	43
5.21.1.3 x_endndx . . . . .	43
5.21.1.4 x_fcn . . . . .	43
5.21.1.5 x_fcny . . . . .	43
5.21.1.6 x_file . . . . .	43
5.21.1.7 x_fname . . . . .	43
5.21.1.8 x_fsize . . . . .	43
5.21.1.9 x_inno . . . . .	43
5.21.1.10 x_innoptr . . . . .	43
5.21.1.11 x_lnsz . . . . .	43
5.21.1.12 x_misc . . . . .	43
5.21.1.13 x_n . . . . .	43
5.21.1.14 x_nlinno . . . . .	43
5.21.1.15 x_nreloc . . . . .	43
5.21.1.16 x_offset . . . . .	43
5.21.1.17 x_scn . . . . .	43
5.21.1.18 x_scnlen . . . . .	43
5.21.1.19 x_size . . . . .	43
5.21.1.20 x_sym . . . . .	43
5.21.1.21 x_tagndx . . . . .	43
5.21.1.22 x_tv . . . . .	43
5.21.1.23 x_tvfill . . . . .	43
5.21.1.24 x_tvlen . . . . .	43

5.21.1.25	x_tvndx	43
5.21.1.26	x_tvrn	43
5.21.1.27	x_zeroes	43
5.22	COFF_filehdr Struct Reference	45
5.22.1	Field Documentation	45
5.22.1.1	f_flags	45
5.22.1.2	f_magic	45
5.22.1.3	f_nsens	45
5.22.1.4	f_nsyms	45
5.22.1.5	f_opthdr	45
5.22.1.6	f_symptr	45
5.22.1.7	f_timdat	45
5.23	COFF_lineno Struct Reference	46
5.23.1	Field Documentation	46
5.23.1.1	l_addr	46
5.23.1.2	l_inno	46
5.23.1.3	l_paddr	46
5.23.1.4	l_symndx	46
5.24	COFF_reloc Struct Reference	47
5.24.1	Field Documentation	47
5.24.1.1	r_symndx	47
5.24.1.2	r_type	47
5.24.1.3	r_vaddr	47
5.25	COFF_scnhdr Struct Reference	48
5.25.1	Field Documentation	48
5.25.1.1	s_flags	48
5.25.1.2	s_innoptr	48
5.25.1.3	s_name	48
5.25.1.4	s_nlnno	48
5.25.1.5	s_nreloc	48
5.25.1.6	s_paddr	48
5.25.1.7	s_relptr	48
5.25.1.8	s_scnptr	48
5.25.1.9	s_size	48
5.25.1.10	s_vaddr	48
5.26	COFF_slb Struct Reference	49

---

5.26.1	Field Documentation	49
5.26.1.1	sl_entsz	49
5.26.1.2	sl_pathndx	49
5.27	COFF_syment Struct Reference	50
5.27.1	Field Documentation	50
5.27.1.1	e	50
5.27.1.2	e	50
5.27.1.3	e_name	50
5.27.1.4	e_numaux	50
5.27.1.5	e_offset	50
5.27.1.6	e_sclass	50
5.27.1.7	e_scnnum	50
5.27.1.8	e_type	50
5.27.1.9	e_value	50
5.27.1.10	e_zeroes	50
5.28	config Struct Reference	51
5.28.1	Detailed Description	53
5.28.2	Field Documentation	55
5.28.2.1	blocksize	55
5.28.2.2	bpb	55
5.28.2.3	btic	55
5.28.2.4	calling_convention	55
5.28.2.5	class_ptr	55
5.28.2.6	clkcycle_ps	55
5.28.2.7	cpu	55
5.28.2.8	cuc	55
5.28.2.9	dc	55
5.28.2.10	debug	55
5.28.2.11	debug	55
5.28.2.12	dependstats	55
5.28.2.13	enable_bursts	55
5.28.2.14	enabled	55
5.28.2.15	exe_log	55
5.28.2.16	exe_log_end	55
5.28.2.17	exe_log_fn	55
5.28.2.18	exe_log_marker	55

---

5.28.2.19	exe_log_start	55
5.28.2.20	exe_log_type	55
5.28.2.21	ext	55
5.28.2.22	gdb_enabled	55
5.28.2.23	hazards	55
5.28.2.24	hide_device_id	55
5.28.2.25	history	55
5.28.2.26	hitdelay	55
5.28.2.27	load_hitdelay	55
5.28.2.28	load_missdelay	55
5.28.2.29	log_enabled	55
5.28.2.30	memory_order	55
5.28.2.31	missdelay	55
5.28.2.32	mprof_fn	55
5.28.2.33	mprofile	55
5.28.2.34	no_multicycle	55
5.28.2.35	nsets	55
5.28.2.36	nways	55
5.28.2.37	pic	55
5.28.2.38	pm	55
5.28.2.39	prof_fn	55
5.28.2.40	profile	55
5.28.2.41	read_up	55
5.28.2.42	rsp_enabled	55
5.28.2.43	rsp_port	55
5.28.2.44	sbp_bf_fwd	55
5.28.2.45	sbp_bnf_fwd	55
5.28.2.46	sbuf_len	55
5.28.2.47	server_port	55
5.28.2.48	sim	55
5.28.2.49	store_hitdelay	55
5.28.2.50	store_missdelay	55
5.28.2.51	strict_npc	55
5.28.2.52	superscalar	55
5.28.2.53	timings_fn	55
5.28.2.54	ustates	55

---

5.28.2.55	vapi	55
5.28.2.56	vapi_fn	55
5.28.2.57	vapi_id	55
5.28.2.58	verbose	55
5.28.2.59	write_up	55
5.29	config::pic Struct Reference	57
5.29.1	Field Documentation	57
5.29.1.1	edge_trigger	57
5.29.1.2	enabled	57
5.30	config_param Struct Reference	58
5.30.1	Field Documentation	58
5.30.1.1	func	58
5.30.1.2	name	58
5.30.1.3	next	58
5.30.1.4	type	58
5.31	config_section Struct Reference	59
5.31.1	Field Documentation	59
5.31.1.1	dat	59
5.31.1.2	name	59
5.31.1.3	next	59
5.31.1.4	params	59
5.31.1.5	sec_end	59
5.31.1.6	sec_start	59
5.32	cpu_state Struct Reference	60
5.32.1	Detailed Description	60
5.32.2	Field Documentation	60
5.32.2.1	delay_insn	60
5.32.2.2	icomplet	60
5.32.2.3	insn_ea	61
5.32.2.4	iqueue	61
5.32.2.5	npc_not_valid	61
5.32.2.6	pc	61
5.32.2.7	pc_delay	61
5.32.2.8	pic_lines	61
5.32.2.9	reg	61
5.32.2.10	sprs	61

---

5.33	cuc_bb Struct Reference	62
5.33.1	Field Documentation	63
5.33.1.1	cnt	63
5.33.1.2	first	63
5.33.1.3	insn	63
5.33.1.4	last	63
5.33.1.5	last_used_reg	63
5.33.1.6	mdep	63
5.33.1.7	next	63
5.33.1.8	ninsn	63
5.33.1.9	nmemory	63
5.33.1.10	ntim	63
5.33.1.11	prev	63
5.33.1.12	selected_tim	63
5.33.1.13	tim	63
5.33.1.14	tmp	63
5.33.1.15	type	63
5.33.1.16	unrolled	63
5.34	cuc_conv Struct Reference	64
5.34.1	Field Documentation	64
5.34.1.1	from	64
5.34.1.2	to	64
5.35	cuc_insn Struct Reference	65
5.35.1	Field Documentation	65
5.35.1.1	dep	65
5.35.1.2	disasm	65
5.35.1.3	index	65
5.35.1.4	insn	65
5.35.1.5	max	65
5.35.1.6	op	65
5.35.1.7	opt	65
5.35.1.8	tmp	65
5.35.1.9	type	65
5.36	cuc_known_insn Struct Reference	66
5.36.1	Field Documentation	66
5.36.1.1	comutative	66

---

5.36.1.2	name	66
5.36.1.3	rtl	66
5.37	cuc_shared_item Struct Reference	67
5.37.1	Field Documentation	67
5.37.1.1	cmatch	67
5.37.1.2	ref	67
5.38	cuc_timing_table Struct Reference	68
5.38.1	Field Documentation	68
5.38.1.1	delay	68
5.38.1.2	delayi	68
5.38.1.3	size	68
5.38.1.4	sizei	68
5.39	cuc_timings Struct Reference	69
5.39.1	Field Documentation	69
5.39.1.1	b	69
5.39.1.2	new_time	69
5.39.1.3	nshared	69
5.39.1.4	preroll	69
5.39.1.5	shared	69
5.39.1.6	size	69
5.39.1.7	unroll	69
5.40	dc_set Struct Reference	70
5.40.1	Field Documentation	70
5.40.1.1	line	70
5.40.1.2	lru	70
5.40.1.3	tagaddr	70
5.40.1.4	way	70
5.41	dev_16450 Struct Reference	71
5.41.1	Field Documentation	74
5.41.1.1	baseaddr	74
5.41.1.2	channel	74
5.41.1.3	channel_str	74
5.41.1.4	char_clks	74
5.41.1.5	dlh	74
5.41.1.6	dll	74
5.41.1.7	enabled	74

---

5.41.1.8	fcv	74
5.41.1.9	fifo_len	74
5.41.1.10	ier	74
5.41.1.11	iir	74
5.41.1.12	ints	74
5.41.1.13	iregs	74
5.41.1.14	irq	74
5.41.1.15	istat	74
5.41.1.16	jitter	74
5.41.1.17	lcr	74
5.41.1.18	loopback	74
5.41.1.19	lsr	74
5.41.1.20	mcr	74
5.41.1.21	msr	74
5.41.1.22	receiveing	74
5.41.1.23	recv_break	74
5.41.1.24	regs	74
5.41.1.25	rxbuf	74
5.41.1.26	rxbuf_full	74
5.41.1.27	rxbuf_head	74
5.41.1.28	rxbuf_tail	74
5.41.1.29	rxser	74
5.41.1.30	scr	74
5.41.1.31	skew	74
5.41.1.32	txbuf	74
5.41.1.33	txbuf_full	74
5.41.1.34	txbuf_head	74
5.41.1.35	txbuf_tail	74
5.41.1.36	txser	74
5.41.1.37	uart16550	74
5.41.1.38	vapi	74
5.41.1.39	vapi_buf	74
5.41.1.40	vapi_buf_head_ptr	74
5.41.1.41	vapi_buf_tail_ptr	74
5.41.1.42	vapi_id	74
5.42	dev_generic Struct Reference	76



---

5.42.1	Detailed Description	76
5.42.2	Member Enumeration Documentation	76
5.42.2.1	"@49	76
5.42.2.2	"@50	76
5.42.3	Field Documentation	77
5.42.3.1	baseaddr	77
5.42.3.2	byte_enabled	77
5.42.3.3	enabled	77
5.42.3.4	hw_enabled	77
5.42.3.5	name	77
5.42.3.6	size	77
5.42.3.7	trans_direction	77
5.42.3.8	trans_size	77
5.42.3.9	value	77
5.42.3.10	word_enabled	77
5.43	dev_memarea Struct Reference	78
5.43.1	Detailed Description	78
5.43.2	Field Documentation	79
5.43.2.1	addr_compare	79
5.43.2.2	addr_mask	79
5.43.2.3	direct_ops	79
5.43.2.4	log	79
5.43.2.5	next	79
5.43.2.6	ops	79
5.43.2.7	size	79
5.43.2.8	size_mask	79
5.43.2.9	valid	79
5.44	dma_channel Struct Reference	80
5.44.1	Field Documentation	81
5.44.1.1	a0	81
5.44.1.2	a1	81
5.44.1.3	am0	81
5.44.1.4	am1	81
5.44.1.5	channel_mask	81
5.44.1.6	channel_number	81
5.44.1.7	chunk_size	81

5.44.1.8	controller	81
5.44.1.9	csr	81
5.44.1.10	current_descriptor	81
5.44.1.11	desc	81
5.44.1.12	destination	81
5.44.1.13	destination_mask	81
5.44.1.14	dma_ack_o	81
5.44.1.15	dma_nd_i	81
5.44.1.16	dma_req_i	81
5.44.1.17	load_next_descriptor_when_done	81
5.44.1.18	referenced	81
5.44.1.19	regs	81
5.44.1.20	source	81
5.44.1.21	source_mask	81
5.44.1.22	swptr	81
5.44.1.23	sz	81
5.44.1.24	total_size	81
5.44.1.25	words_transferred	81
5.45	dma_controller Struct Reference	83
5.45.1	Field Documentation	84
5.45.1.1	baseaddr	84
5.45.1.2	ch	84
5.45.1.3	csr	84
5.45.1.4	enabled	84
5.45.1.5	int_msk_a	84
5.45.1.6	int_msk_b	84
5.45.1.7	int_src_a	84
5.45.1.8	int_src_b	84
5.45.1.9	irq	84
5.45.1.10	next	84
5.45.1.11	regs	84
5.45.1.12	vapi_id	84
5.46	dmmu Struct Reference	85
5.46.1	Field Documentation	86
5.46.1.1	enabled	86
5.46.1.2	entrysize	86

5.46.1.3	hitdelay	86
5.46.1.4	lru_reload	86
5.46.1.5	missdelay	86
5.46.1.6	nsets	86
5.46.1.7	nways	86
5.46.1.8	page_mask	86
5.46.1.9	page_offset_mask	86
5.46.1.10	pagesize	86
5.46.1.11	pagesize_log2	86
5.46.1.12	set_mask	86
5.46.1.13	ustates	86
5.46.1.14	vpn_mask	86
5.47	dmmustats_entry Struct Reference	87
5.47.1	Field Documentation	87
5.47.1.1	loads_pagefaults	87
5.47.1.2	loads_tlbhit	87
5.47.1.3	loads_tlbmiss	87
5.47.1.4	stores_pagefaults	87
5.47.1.5	stores_tlbhit	87
5.47.1.6	stores_tlbmiss	87
5.48	dstats_entry Struct Reference	88
5.48.1	Field Documentation	88
5.48.1.1	cnt_dynamic	88
5.48.1.2	depend	88
5.48.1.3	insn1	88
5.48.1.4	insn2	88
5.49	dyn_page Struct Reference	89
5.49.1	Field Documentation	89
5.49.1.1	delayr	89
5.49.1.2	dirty	89
5.49.1.3	host_len	89
5.49.1.4	host_page	89
5.49.1.5	insn_indexs	89
5.49.1.6	insns	89
5.49.1.7	locs	89
5.49.1.8	or_page	89

5.49.1.9	ts_bound	89
5.50	dynamic Struct Reference	90
5.50.1	Field Documentation	90
5.50.1.1	d_ptr	90
5.50.1.2	d_tag	90
5.50.1.3	d_un	90
5.50.1.4	d_val	90
5.51	elf32_hdr Struct Reference	91
5.51.1	Field Documentation	92
5.51.1.1	e_ehsize	92
5.51.1.2	e_entry	92
5.51.1.3	e_flags	92
5.51.1.4	e_ident	92
5.51.1.5	e_machine	92
5.51.1.6	e_phentsize	92
5.51.1.7	e_phnum	92
5.51.1.8	e_phoff	92
5.51.1.9	e_shentsize	92
5.51.1.10	e_shnum	92
5.51.1.11	e_shoff	92
5.51.1.12	e_shstrndx	92
5.51.1.13	e_type	92
5.51.1.14	e_version	92
5.52	elf32_note Struct Reference	93
5.52.1	Field Documentation	93
5.52.1.1	n_descsz	93
5.52.1.2	n_namesz	93
5.52.1.3	n_type	93
5.53	elf32_phdr Struct Reference	94
5.53.1	Field Documentation	94
5.53.1.1	p_align	94
5.53.1.2	p_filesz	94
5.53.1.3	p_flags	94
5.53.1.4	p_memsz	94
5.53.1.5	p_offset	94
5.53.1.6	p_paddr	94

---

5.53.1.7	p_type	94
5.53.1.8	p_vaddr	94
5.54	elf32_rel Struct Reference	95
5.54.1	Field Documentation	95
5.54.1.1	r_info	95
5.54.1.2	r_offset	95
5.55	elf32_rela Struct Reference	96
5.55.1	Field Documentation	96
5.55.1.1	r_addend	96
5.55.1.2	r_info	96
5.55.1.3	r_offset	96
5.56	elf32_shdr Struct Reference	97
5.56.1	Field Documentation	97
5.56.1.1	sh_addr	97
5.56.1.2	sh_addralign	97
5.56.1.3	sh_entsize	97
5.56.1.4	sh_flags	97
5.56.1.5	sh_info	97
5.56.1.6	sh_link	97
5.56.1.7	sh_name	97
5.56.1.8	sh_offset	97
5.56.1.9	sh_size	97
5.56.1.10	sh_type	97
5.57	elf32_sym Struct Reference	98
5.57.1	Field Documentation	98
5.57.1.1	st_info	98
5.57.1.2	st_name	98
5.57.1.3	st_other	98
5.57.1.4	st_shndx	98
5.57.1.5	st_size	98
5.57.1.6	st_value	98
5.58	Elf64_Dyn Struct Reference	99
5.58.1	Field Documentation	99
5.58.1.1	d_ptr	99
5.58.1.2	d_tag	99
5.58.1.3	d_un	99

---

5.58.1.4	d_val	99
5.59	elf64_hdr Struct Reference	100
5.59.1	Field Documentation	101
5.59.1.1	e_ehsize	101
5.59.1.2	e_entry	101
5.59.1.3	e_flags	101
5.59.1.4	e_ident	101
5.59.1.5	e_machine	101
5.59.1.6	e_phentsize	101
5.59.1.7	e_phnum	101
5.59.1.8	e_phoff	101
5.59.1.9	e_shentsize	101
5.59.1.10	e_shnum	101
5.59.1.11	e_shoff	101
5.59.1.12	e_shstrndx	101
5.59.1.13	e_type	101
5.59.1.14	e_version	101
5.60	elf64_note Struct Reference	102
5.60.1	Field Documentation	102
5.60.1.1	n_descsz	102
5.60.1.2	n_namesz	102
5.60.1.3	n_type	102
5.61	elf64_phdr Struct Reference	103
5.61.1	Field Documentation	103
5.61.1.1	p_align	103
5.61.1.2	p_filesz	103
5.61.1.3	p_flags	103
5.61.1.4	p_memsz	103
5.61.1.5	p_offset	103
5.61.1.6	p_paddr	103
5.61.1.7	p_type	103
5.61.1.8	p_vaddr	103
5.62	elf64_rel Struct Reference	104
5.62.1	Field Documentation	104
5.62.1.1	r_info	104
5.62.1.2	r_offset	104

---

5.63	elf64_rela Struct Reference	105
5.63.1	Field Documentation	105
5.63.1.1	r_addend	105
5.63.1.2	r_info	105
5.63.1.3	r_offset	105
5.64	elf64_shdr Struct Reference	106
5.64.1	Field Documentation	106
5.64.1.1	sh_addr	106
5.64.1.2	sh_addralign	106
5.64.1.3	sh_entsize	106
5.64.1.4	sh_flags	106
5.64.1.5	sh_info	106
5.64.1.6	sh_link	106
5.64.1.7	sh_name	106
5.64.1.8	sh_offset	106
5.64.1.9	sh_size	106
5.64.1.10	sh_type	106
5.65	elf64_sym Struct Reference	107
5.65.1	Field Documentation	107
5.65.1.1	st_info	107
5.65.1.2	st_name	107
5.65.1.3	st_other	107
5.65.1.4	st_shndx	107
5.65.1.5	st_size	107
5.65.1.6	st_value	107
5.66	elf_obj Struct Reference	108
5.66.1	Field Documentation	109
5.66.1.1	e_hdr	109
5.66.1.2	e_rel_num	109
5.66.1.3	e_rel_sec	109
5.66.1.4	e_rel_sym	109
5.66.1.5	e_rela_num	109
5.66.1.6	e_rela_sec	109
5.66.1.7	e_rela_sym	109
5.66.1.8	e_relas	109
5.66.1.9	e_rels	109

---

5.66.1.10	e_sections	109
5.66.1.11	e_shdrs	109
5.66.1.12	e_sym_num	109
5.66.1.13	e_sym_str_tab	109
5.66.1.14	e_syms	109
5.67	eth_device Struct Reference	110
5.67.1	Field Documentation	113
5.67.1.1	add_crc	113
5.67.1.2	base_vapi_id	113
5.67.1.3	baseaddr	113
5.67.1.4	bd	113
5.67.1.5	bd_addr	113
5.67.1.6	bd_index	113
5.67.1.7	bd_ram	113
5.67.1.8	bytes_left	113
5.67.1.9	bytes_read	113
5.67.1.10	bytes_sent	113
5.67.1.11	collconf	113
5.67.1.12	controlmoder	113
5.67.1.13	crc_dly	113
5.67.1.14	crc_value	113
5.67.1.15	dma	113
5.67.1.16	enabled	113
5.67.1.17	error	113
5.67.1.18	fd	113
5.67.1.19	hash0	113
5.67.1.20	hash1	113
5.67.1.21	ifr	113
5.67.1.22	int_mask	113
5.67.1.23	int_source	113
5.67.1.24	ipgr1	113
5.67.1.25	ipgr2	113
5.67.1.26	ipgt	113
5.67.1.27	lo_buff	113
5.67.1.28	loopback_offset	113
5.67.1.29	mac_address	113



---

5.67.1.30	mac_int	113
5.67.1.31	maximum_length	113
5.67.1.32	miiaddress	113
5.67.1.33	miicommand	113
5.67.1.34	miimoder	113
5.67.1.35	miirx_data	113
5.67.1.36	miistatus	113
5.67.1.37	miitx_data	113
5.67.1.38	minimum_length	113
5.67.1.39	moder	113
5.67.1.40	offset	113
5.67.1.41	packet_length	113
5.67.1.42	packetlen	113
5.67.1.43	regs	113
5.67.1.44	rfd	113
5.67.1.45	rx_sock	113
5.67.1.46	rx_type	113
5.67.1.47	rx	113
5.67.1.48	rx_buff	113
5.67.1.49	rx_channel	113
5.67.1.50	rxfd	113
5.67.1.51	rxfile	113
5.67.1.52	sockif	113
5.67.1.53	state	113
5.67.1.54	tx	113
5.67.1.55	tx_bd_num	113
5.67.1.56	tx_buff	113
5.67.1.57	tx_channel	113
5.67.1.58	txfd	113
5.67.1.59	txfile	113
5.67.1.60	waiting_for_dma	113
5.67.1.61	wfd	113
5.67.1.62	working	113
5.68	ether_addr Struct Reference	115
5.68.1	Field Documentation	115
5.68.1.1	ether_addr_octet	115

---

5.69	ether_header Struct Reference	116
5.69.1	Field Documentation	116
5.69.1.1	ether_dhost	116
5.69.1.2	ether_shost	116
5.69.1.3	ether_type	116
5.70	fb_state Struct Reference	117
5.70.1	Field Documentation	118
5.70.1.1	addr	118
5.70.1.2	baseaddr	118
5.70.1.3	cam_addr	118
5.70.1.4	camera_pos	118
5.70.1.5	camerax	118
5.70.1.6	cameray	118
5.70.1.7	ctrl	118
5.70.1.8	enabled	118
5.70.1.9	filename	118
5.70.1.10	in_refresh	118
5.70.1.11	pal	118
5.70.1.12	pic	118
5.70.1.13	refresh	118
5.70.1.14	refresh_count	118
5.70.1.15	refresh_rate	118
5.71	fd_channel Struct Reference	119
5.71.1	Detailed Description	119
5.71.2	Field Documentation	119
5.71.2.1	fdin	119
5.71.2.2	fdout	119
5.72	file_channel Struct Reference	120
5.72.1	Detailed Description	120
5.72.2	Field Documentation	120
5.72.2.1	fds	120
5.72.2.2	namein	120
5.72.2.3	nameout	120
5.73	fstats_entry Struct Reference	121
5.73.1	Field Documentation	121
5.73.1.1	cnt_dynamic	121

---

5.73.1.2	depend	121
5.73.1.3	insn1	121
5.73.1.4	insn2	121
5.74	func_struct Struct Reference	122
5.74.1	Detailed Description	122
5.74.2	Field Documentation	122
5.74.2.1	addr	122
5.74.2.2	calls	122
5.74.2.3	cum_cycles	122
5.74.2.4	name	122
5.75	gpio_device Struct Reference	123
5.75.1	Field Documentation	124
5.75.1.1	aux	124
5.75.1.2	auxiliary_inputs	124
5.75.1.3	base_vapi_id	124
5.75.1.4	baseaddr	124
5.75.1.5	ctrl	124
5.75.1.6	curr	124
5.75.1.7	enabled	124
5.75.1.8	external_clock	124
5.75.1.9	gpio_number	124
5.75.1.10	in	124
5.75.1.11	inte	124
5.75.1.12	ints	124
5.75.1.13	irq	124
5.75.1.14	next	124
5.75.1.15	oe	124
5.75.1.16	out	124
5.75.1.17	ptrig	124
5.76	hist_exec Struct Reference	125
5.76.1	Detailed Description	125
5.76.2	Field Documentation	125
5.76.2.1	addr	125
5.76.2.2	next	125
5.76.2.3	prev	125
5.77	ic Struct Reference	126

5.77.1	Field Documentation	127
5.77.1.1	block_mask	127
5.77.1.2	block_offset_mask	127
5.77.1.3	blocksize	127
5.77.1.4	blocksize_log2	127
5.77.1.5	enabled	127
5.77.1.6	hitdelay	127
5.77.1.7	last_way	127
5.77.1.8	lrus	127
5.77.1.9	mem	127
5.77.1.10	missdelay	127
5.77.1.11	nsets	127
5.77.1.12	nways	127
5.77.1.13	set_mask	127
5.77.1.14	tagaddr_mask	127
5.77.1.15	tags	127
5.77.1.16	ustates	127
5.77.1.17	ustates_reload	127
5.78	immu Struct Reference	128
5.78.1	Field Documentation	129
5.78.1.1	enabled	129
5.78.1.2	entrysize	129
5.78.1.3	hitdelay	129
5.78.1.4	lru_reload	129
5.78.1.5	missdelay	129
5.78.1.6	nsets	129
5.78.1.7	nways	129
5.78.1.8	page_mask	129
5.78.1.9	page_offset_mask	129
5.78.1.10	pagesize	129
5.78.1.11	pagesize_log2	129
5.78.1.12	set_mask	129
5.78.1.13	ustates	129
5.78.1.14	vpn_mask	129
5.79	immustats_entry Struct Reference	130
5.79.1	Field Documentation	130

5.79.1.1	fetch_pagefaults	130
5.79.1.2	fetch_tlbhit	130
5.79.1.3	fetch_tlbmiss	130
5.80	INFOHEADER Struct Reference	131
5.80.1	Field Documentation	131
5.80.1.1	bits	131
5.80.1.2	compression	131
5.80.1.3	height	131
5.80.1.4	imagesize	131
5.80.1.5	importantcolours	131
5.80.1.6	ncolours	131
5.80.1.7	planes	131
5.80.1.8	size	131
5.80.1.9	width	131
5.80.1.10	xresolution	131
5.80.1.11	yresolution	131
5.81	iqueue_entry Struct Reference	132
5.81.1	Detailed Description	132
5.81.2	Field Documentation	132
5.81.2.1	insn	132
5.81.2.2	insn_addr	132
5.81.2.3	insn_index	132
5.82	jtr_chain_message Struct Reference	133
5.82.1	Field Documentation	133
5.82.1.1	chain	133
5.82.1.2	command	133
5.82.1.3	length	133
5.83	jtr_chain_response Struct Reference	134
5.83.1	Field Documentation	134
5.83.1.1	status	134
5.84	jtr_failure_response Struct Reference	135
5.84.1	Field Documentation	135
5.84.1.1	status	135
5.85	jtr_read_block_message Struct Reference	136
5.85.1	Field Documentation	136
5.85.1.1	address	136

---

5.85.1.2	command	136
5.85.1.3	length	136
5.85.1.4	num_regs	136
5.86	jtr_read_block_response Struct Reference	137
5.86.1	Field Documentation	137
5.86.1.1	data	137
5.86.1.2	num_regs	137
5.86.1.3	status	137
5.87	jtr_read_message Struct Reference	138
5.87.1	Field Documentation	138
5.87.1.1	address	138
5.87.1.2	command	138
5.87.1.3	length	138
5.88	jtr_read_response Struct Reference	139
5.88.1	Field Documentation	139
5.88.1.1	data_h	139
5.88.1.2	data_l	139
5.88.1.3	status	139
5.89	jtr_write_block_message Struct Reference	140
5.89.1	Field Documentation	140
5.89.1.1	address	140
5.89.1.2	command	140
5.89.1.3	data	140
5.89.1.4	length	140
5.89.1.5	num_regs	140
5.90	jtr_write_block_response Struct Reference	141
5.90.1	Field Documentation	141
5.90.1.1	status	141
5.91	jtr_write_message Struct Reference	142
5.91.1	Field Documentation	142
5.91.1.1	address	142
5.91.1.2	command	142
5.91.1.3	data_h	142
5.91.1.4	data_l	142
5.91.1.5	length	142
5.92	jtr_write_response Struct Reference	143

---

5.92.1	Field Documentation	143
5.92.1.1	status	143
5.93	kbd_state Struct Reference	144
5.93.1	Field Documentation	144
5.93.1.1	baseaddr	144
5.93.1.2	buf	144
5.93.1.3	buf_count	144
5.93.1.4	buf_head	144
5.93.1.5	buf_tail	144
5.93.1.6	ccmd	144
5.93.1.7	ccmdbyte	144
5.93.1.8	enabled	144
5.93.1.9	irq	144
5.93.1.10	kcmd	144
5.93.1.11	kresp	144
5.93.1.12	rxfile	144
5.93.1.13	rxfs	144
5.93.1.14	slowdown	144
5.94	label_entry Struct Reference	145
5.94.1	Detailed Description	145
5.94.2	Field Documentation	145
5.94.2.1	addr	145
5.94.2.2	name	145
5.94.2.3	next	145
5.95	mc Struct Reference	146
5.95.1	Field Documentation	147
5.95.1.1	ba_mask	147
5.95.1.2	baseaddr	147
5.95.1.3	csc	147
5.95.1.4	csr	147
5.95.1.5	enabled	147
5.95.1.6	index	147
5.95.1.7	mc_areas	147
5.95.1.8	next	147
5.95.1.9	poc	147
5.95.1.10	tms	147

---

5.96	mc_area Struct Reference	148
5.96.1	Field Documentation	148
5.96.1.1	cs	148
5.96.1.2	mc	148
5.96.1.3	mem	148
5.96.1.4	next	148
5.97	mem_config Struct Reference	149
5.97.1	Member Enumeration Documentation	149
5.97.1.1	"@53	149
5.97.2	Field Documentation	150
5.97.2.1	baseaddr	150
5.97.2.2	ce	150
5.97.2.3	delayr	150
5.97.2.4	delayw	150
5.97.2.5	log	150
5.97.2.6	mc	150
5.97.2.7	mem	150
5.97.2.8	name	150
5.97.2.9	pattern	150
5.97.2.10	random_seed	150
5.97.2.11	size	150
5.97.2.12	type	150
5.98	mem_ops Struct Reference	151
5.98.1	Detailed Description	151
5.98.2	Field Documentation	152
5.98.2.1	delayr	152
5.98.2.2	delayw	152
5.98.2.3	log	152
5.98.2.4	read_dat16	152
5.98.2.5	read_dat32	152
5.98.2.6	read_dat8	152
5.98.2.7	readfunc16	152
5.98.2.8	readfunc32	152
5.98.2.9	readfunc8	152
5.98.2.10	write_dat16	152
5.98.2.11	write_dat32	152



---

5.98.2.12	write_dat8	152
5.98.2.13	writefunc16	152
5.98.2.14	writefunc32	152
5.98.2.15	writefunc8	152
5.98.2.16	writeprog32	152
5.98.2.17	writeprog32_dat	152
5.98.2.18	writeprog8	152
5.98.2.19	writeprog8_dat	152
5.99	memory_hash Struct Reference	153
5.99.1	Detailed Description	153
5.99.2	Field Documentation	153
5.99.2.1	addr	153
5.99.2.2	cnt	153
5.99.2.3	next	153
5.100	mp_entry Struct Reference	154
5.100.1	Detailed Description	154
5.100.2	Field Documentation	154
5.100.2.1	addr	154
5.100.2.2	instr	154
5.100.2.3	next	154
5.100.2.4	type	154
5.101	mprofentry_struct Struct Reference	155
5.101.1	Field Documentation	155
5.101.1.1	addr	155
5.101.1.2	type	155
5.102	mstats_entry Struct Reference	156
5.102.1	Field Documentation	156
5.102.1.1	bf	156
5.102.1.2	bnf	156
5.102.1.3	bpb	156
5.102.1.4	btic	156
5.102.1.5	byteadd	156
5.103	op_queue Struct Reference	157
5.103.1	Field Documentation	158
5.103.1.1	insn	158
5.103.1.2	insn_addr	158

5.103.1.3	insn_index	158
5.103.1.4	jump_local	158
5.103.1.5	jump_local_loc	158
5.103.1.6	next	158
5.103.1.7	not_jump_loc	158
5.103.1.8	num_ops	158
5.103.1.9	num_ops_param	158
5.103.1.10	ops	158
5.103.1.11	ops_len	158
5.103.1.12	ops_param	158
5.103.1.13	ops_param_len	158
5.103.1.14	param	158
5.103.1.15	param_num	158
5.103.1.16	param_type	158
5.103.1.17	prev	158
5.103.1.18	reg_t	158
5.103.1.19	flags	158
5.103.1.20	ref	158
5.104	param_val Union Reference	159
5.104.1	Detailed Description	159
5.104.2	Field Documentation	159
5.104.2.1	addr_val	159
5.104.2.2	int_val	159
5.104.2.3	longlong_val	159
5.104.2.4	str_val	159
5.105	raw_stats Struct Reference	160
5.105.1	Field Documentation	160
5.105.1.1	range	160
5.105.1.2	reg	160
5.106	reloc Struct Reference	161
5.106.1	Field Documentation	161
5.106.1.1	addend	161
5.106.1.2	func_offset	161
5.106.1.3	name	161
5.106.1.4	type	161
5.107	rsp_buf Struct Reference	162

---

5.107.1 Detailed Description	162
5.107.2 Field Documentation	162
5.107.2.1 data	162
5.107.2.2 len	162
5.108 runtime Struct Reference	163
5.108.1 Detailed Description	163
5.108.2 Field Documentation	165
5.108.2.1 cpu	165
5.108.2.2 cuc	165
5.108.2.3 cycle_duration	165
5.108.2.4 cycles	165
5.108.2.5 enabled	165
5.108.2.6 end_cycles	165
5.108.2.7 ext_int_clr	165
5.108.2.8 ext_int_set	165
5.108.2.9 fexe_log	165
5.108.2.10 filename	165
5.108.2.11 fprof	165
5.108.2.12 fout	165
5.108.2.13 fprof	165
5.108.2.14 hazardwait	165
5.108.2.15 hush	165
5.108.2.16 instructions	165
5.108.2.17 prompt	165
5.108.2.18 prompt_run	165
5.108.2.19 loadcycles	165
5.108.2.20 mdelay	165
5.108.2.21 mem_cycles	165
5.108.2.22 reset_cycles	165
5.108.2.23 reset_instructions	165
5.108.2.24 server_port	165
5.108.2.25 sim	165
5.108.2.26 stalled	165
5.108.2.27 storecycles	165
5.108.2.28 supercycles	165
5.108.2.29 time_point	165

5.108.2.30vapi	165
5.108.2.31vapi_file	165
5.109sched_entry Struct Reference	167
5.109.1 Detailed Description	167
5.109.2 Field Documentation	167
5.109.2.1 func	167
5.109.2.2 next	167
5.109.2.3 param	167
5.109.2.4 time	167
5.110scheduler_struct Struct Reference	168
5.110.1 Detailed Description	168
5.110.2 Field Documentation	168
5.110.2.1 free_job_queue	168
5.110.2.2 job_queue	168
5.111sim_command Struct Reference	169
5.111.1 Field Documentation	169
5.111.1.1 cmd_handle	169
5.111.1.2 name	169
5.112sim_reset_hook Struct Reference	170
5.112.1 Detailed Description	170
5.112.2 Field Documentation	170
5.112.2.1 dat	170
5.112.2.2 next	170
5.112.2.3 reset_hook	170
5.113sim_stat Struct Reference	171
5.113.1 Field Documentation	171
5.113.1.1 dat	171
5.113.1.2 next	171
5.113.1.3 stat_func	171
5.114spr_bit_def Struct Reference	172
5.114.1 Field Documentation	172
5.114.1.1 mask	172
5.114.1.2 name	172
5.115spr_def Struct Reference	173
5.115.1 Field Documentation	173
5.115.1.1 bits	173

---

5.115.1.2 from_spr . . . . .	173
5.115.1.3 name . . . . .	173
5.115.1.4 to_spr . . . . .	173
5.116sstats_entry Struct Reference . . . . .	174
5.116.1 Field Documentation . . . . .	174
5.116.1.1 cnt_dynamic . . . . .	174
5.116.1.2 insn . . . . .	174
5.117stack_struct Struct Reference . . . . .	175
5.117.1 Detailed Description . . . . .	175
5.117.2 Field Documentation . . . . .	175
5.117.2.1 addr . . . . .	175
5.117.2.2 cycles . . . . .	175
5.117.2.3 name . . . . .	175
5.117.2.4 raddr . . . . .	175
5.118tcp_channel Struct Reference . . . . .	176
5.118.1 Detailed Description . . . . .	176
5.118.2 Field Documentation . . . . .	176
5.118.2.1 connected . . . . .	176
5.118.2.2 fds . . . . .	176
5.118.2.3 nonblocking . . . . .	176
5.118.2.4 port_number . . . . .	176
5.118.2.5 socket_fd . . . . .	176
5.119tty_channel Struct Reference . . . . .	177
5.119.1 Detailed Description . . . . .	177
5.119.2 Field Documentation . . . . .	177
5.119.2.1 fds . . . . .	177
5.120vapi_handler Struct Reference . . . . .	178
5.120.1 Field Documentation . . . . .	178
5.120.1.1 base_id . . . . .	178
5.120.1.2 fd . . . . .	178
5.120.1.3 next . . . . .	178
5.120.1.4 num_ids . . . . .	178
5.120.1.5 priv_dat . . . . .	178
5.120.1.6 read_func . . . . .	178
5.120.1.7 temp . . . . .	178
5.121vga_state Struct Reference . . . . .	179

5.121.1 Field Documentation . . . . .	180
5.121.1.1 baseaddr . . . . .	180
5.121.1.2 ctrl . . . . .	180
5.121.1.3 enabled . . . . .	180
5.121.1.4 filename . . . . .	180
5.121.1.5 hlen . . . . .	180
5.121.1.6 htim . . . . .	180
5.121.1.7 irq . . . . .	180
5.121.1.8 palette . . . . .	180
5.121.1.9 pics . . . . .	180
5.121.1.10pindex . . . . .	180
5.121.1.11refresh_rate . . . . .	180
5.121.1.12stat . . . . .	180
5.121.1.13vbar . . . . .	180
5.121.1.14vbindx . . . . .	180
5.121.1.15vlen . . . . .	180
5.121.1.16vtim . . . . .	180
5.122xterm_channel Struct Reference . . . . .	181
5.122.1 Detailed Description . . . . .	181
5.122.2 Field Documentation . . . . .	181
5.122.2.1 argv . . . . .	181
5.122.2.2 fds . . . . .	181
5.122.2.3 pid . . . . .	181
<b>6 File Documentation . . . . .</b>	<b>183</b>
6.1 bpb/branch-predict.c File Reference . . . . .	183
6.1.1 Define Documentation . . . . .	186
6.1.1.1 BPB_LEN . . . . .	186
6.1.1.2 BPB_PSTATES . . . . .	186
6.1.1.3 BPB_USTATES . . . . .	186
6.1.1.4 BPB_WAYS . . . . .	186
6.1.1.5 BTIC_BLOCKSIZE . . . . .	186
6.1.1.6 BTIC_LEN . . . . .	186
6.1.1.7 BTIC_USTATES . . . . .	186
6.1.1.8 BTIC_WAYS . . . . .	186
6.1.2 Function Documentation . . . . .	186
6.1.2.1 bpb_btic . . . . .	186

6.1.2.2	<code>bpb_enabled</code>	186
6.1.2.3	<code>bpb_hitdelay</code>	186
6.1.2.4	<code>bpb_info</code>	186
6.1.2.5	<code>bpb_missdelay</code>	186
6.1.2.6	<code>bpb_sbp_bf_fwd</code>	186
6.1.2.7	<code>bpb_sbp_bnf_fwd</code>	186
6.1.2.8	<code>bpb_update</code>	186
6.1.2.9	<code>btic_info</code>	186
6.1.2.10	<code>btic_update</code>	186
6.1.2.11	<code>reg_bpb_sec</code>	186
6.1.3	Variable Documentation	187
6.1.3.1	<code>bpb</code>	187
6.1.3.2	<code>btic</code>	187
6.2	<code>bpb/branch-predict.h</code> File Reference	188
6.2.1	Function Documentation	189
6.2.1.1	<code>bpb_info</code>	189
6.2.1.2	<code>bpb_update</code>	189
6.2.1.3	<code>btic_info</code>	189
6.2.1.4	<code>btic_update</code>	189
6.2.1.5	<code>reg_bpb_sec</code>	189
6.3	<code>cache/dcache-model.c</code> File Reference	190
6.3.1	Function Documentation	191
6.3.1.1	<code>dc_blocksize</code>	191
6.3.1.2	<code>dc_enabled</code>	191
6.3.1.3	<code>dc_info</code>	191
6.3.1.4	<code>dc_inv</code>	191
6.3.1.5	<code>dc_load_hitdelay</code>	191
6.3.1.6	<code>dc_load_missdelay</code>	191
6.3.1.7	<code>dc_nsets</code>	191
6.3.1.8	<code>dc_nways</code>	192
6.3.1.9	<code>dc_simulate_read</code>	192
6.3.1.10	<code>dc_simulate_write</code>	193
6.3.1.11	<code>dc_store_hitdelay</code>	193
6.3.1.12	<code>dc_store_missdelay</code>	193
6.3.1.13	<code>dc_ustates</code>	193
6.3.1.14	<code>reg_dc_sec</code>	194

6.3.2	Variable Documentation	194
6.3.2.1	dc	194
6.4	cache/dcache-model.h File Reference	195
6.4.1	Define Documentation	196
6.4.1.1	MAX_DC_BLOCK_SIZE	196
6.4.1.2	MAX_DC_SETS	196
6.4.1.3	MAX_DC_WAYS	196
6.4.1.4	MIN_DC_BLOCK_SIZE	196
6.4.2	Function Documentation	196
6.4.2.1	dc_info	196
6.4.2.2	dc_inv	196
6.4.2.3	dc_simulate_read	196
6.4.2.4	dc_simulate_write	197
6.4.2.5	reg_dc_sec	197
6.5	cache/icache-model.c File Reference	198
6.5.1	Define Documentation	199
6.5.1.1	MAX_IC_BLOCK_SIZE	199
6.5.1.2	MAX_IC_SETS	199
6.5.1.3	MAX_IC_WAYS	199
6.5.1.4	MIN_IC_BLOCK_SIZE	199
6.5.2	Function Documentation	199
6.5.2.1	ic_blocksize	199
6.5.2.2	ic_enabled	199
6.5.2.3	ic_end_sec	200
6.5.2.4	ic_hitdelay	200
6.5.2.5	ic_info	200
6.5.2.6	ic_inv	200
6.5.2.7	ic_missdelay	200
6.5.2.8	ic_nsets	200
6.5.2.9	ic_nways	200
6.5.2.10	ic_simulate_fetch	201
6.5.2.11	ic_start_sec	201
6.5.2.12	ic_ustates	201
6.5.2.13	reg_ic_sec	202
6.5.3	Variable Documentation	202
6.5.3.1	ic_state	202



6.6	cache/icache-model.h File Reference	203
6.6.1	Function Documentation	204
6.6.1.1	ic_inv	204
6.6.1.2	ic_simulate_fetch	204
6.6.1.3	reg_ic_sec	204
6.6.2	Variable Documentation	205
6.6.2.1	ic_state	205
6.7	cpu-config.c File Reference	206
6.7.1	Define Documentation	207
6.7.1.1	WARNING	207
6.7.2	Function Documentation	207
6.7.2.1	cpu_cfg	207
6.7.2.2	cpu_cfgr	207
6.7.2.3	cpu_dependstats	207
6.7.2.4	cpu_hazards	207
6.7.2.5	cpu_rev	207
6.7.2.6	cpu_sbuf_len	207
6.7.2.7	cpu_sr	207
6.7.2.8	cpu_superscalar	208
6.7.2.9	cpu_upr	208
6.7.2.10	cpu_ver	208
6.7.2.11	reg_cpu_sec	208
6.8	cpu-config.h File Reference	210
6.8.1	Function Documentation	210
6.8.1.1	reg_cpu_sec	210
6.9	cpu/common/abstract.c File Reference	211
6.9.1	Function Documentation	213
6.9.1.1	adjust_rw_delay	213
6.9.1.2	bit_mask	213
6.9.1.3	disassemble_memory	213
6.9.1.4	done_memory_table	213
6.9.1.5	dump_memory	213
6.9.1.6	eval_direct16	214
6.9.1.7	eval_direct32	215
6.9.1.8	eval_direct8	215
6.9.1.9	eval_insn	215

---

6.9.1.10	eval_mem16	216
6.9.1.11	eval_mem32	216
6.9.1.12	eval_mem8	217
6.9.1.13	eval_mem_16_inv	217
6.9.1.14	eval_mem_16_inv_direct	218
6.9.1.15	eval_mem_32_inv	218
6.9.1.16	eval_mem_32_inv_direct	218
6.9.1.17	eval_mem_8_inv	218
6.9.1.18	eval_mem_8_inv_direct	219
6.9.1.19	evalsim_mem16	219
6.9.1.20	evalsim_mem32	219
6.9.1.21	evalsim_mem8	220
6.9.1.22	generate_time_pretty	220
6.9.1.23	memory_table_status	220
6.9.1.24	reg_mem_area	221
6.9.1.25	register_memoryarea_mask	221
6.9.1.26	set_direct16	222
6.9.1.27	set_direct32	222
6.9.1.28	set_direct8	223
6.9.1.29	set_mem16	223
6.9.1.30	set_mem32	224
6.9.1.31	set_mem8	224
6.9.1.32	set_mem_16_inv	225
6.9.1.33	set_mem_16_inv_direct	225
6.9.1.34	set_mem_32_inv	225
6.9.1.35	set_mem_32_inv_direct	226
6.9.1.36	set_mem_8_inv	226
6.9.1.37	set_mem_8_inv_direct	226
6.9.1.38	set_mem_valid	226
6.9.1.39	set_program32	226
6.9.1.40	set_program8	226
6.9.1.41	setsim_mem16	227
6.9.1.42	setsim_mem32	227
6.9.1.43	setsim_mem8	227
6.9.1.44	verify_memoryarea	228
6.9.2	Variable Documentation	228

---

6.9.2.1	cur_area	228
6.9.2.2	cur_vadd	228
6.9.2.3	data_ci	228
6.9.2.4	dev_list	228
6.9.2.5	insn_ci	228
6.9.2.6	mc_area	228
6.10	cpu/common/abstract.h File Reference	229
6.10.1	Define Documentation	231
6.10.1.1	CT_NONE	231
6.10.1.2	CT_PHYSICAL	231
6.10.1.3	CT_VIRTUAL	231
6.10.1.4	DEFAULT_MEMORY_LEN	231
6.10.1.5	DEFAULT_MEMORY_START	231
6.10.1.6	HISTEXEC_LEN	231
6.10.1.7	INSNAME_LEN	231
6.10.1.8	LABELNAME_LEN	231
6.10.1.9	LE16	231
6.10.1.10	LONGEST	231
6.10.1.11	MAX_OPERANDS	231
6.10.1.12	OP_MEM_ACCESS	231
6.10.1.13	OPERANDNAME_LEN	231
6.10.1.14	STACK_SIZE	231
6.10.1.15	ULONGEST	231
6.10.2	Function Documentation	231
6.10.2.1	adjust_rw_delay	231
6.10.2.2	disassemble_memory	231
6.10.2.3	done_memory_table	232
6.10.2.4	dump_memory	232
6.10.2.5	eval_direct16	233
6.10.2.6	eval_direct32	233
6.10.2.7	eval_direct8	234
6.10.2.8	eval_insn	234
6.10.2.9	eval_mem16	235
6.10.2.10	eval_mem32	235
6.10.2.11	eval_mem8	236
6.10.2.12	evalsim_mem16	236

6.10.2.13	evalsim_mem32	237
6.10.2.14	evalsim_mem8	237
6.10.2.15	generate_time_pretty	237
6.10.2.16	memory_table_status	237
6.10.2.17	reg_mem_area	238
6.10.2.18	set_direct16	238
6.10.2.19	set_direct32	239
6.10.2.20	set_direct8	239
6.10.2.21	set_mem16	240
6.10.2.22	set_mem32	240
6.10.2.23	set_mem8	241
6.10.2.24	set_mem_valid	241
6.10.2.25	set_program32	241
6.10.2.26	set_program8	241
6.10.2.27	setsim_mem16	242
6.10.2.28	setsim_mem32	242
6.10.2.29	setsim_mem8	242
6.10.2.30	verify_memoryarea	243
6.10.3	Variable Documentation	243
6.10.3.1	cur_area	243
6.10.3.2	data_ci	243
6.10.3.3	hist_exec_tail	243
6.10.3.4	insn_ci	243
6.11	cpu/common/coff.h File Reference	244
6.11.1	Define Documentation	249
6.11.1.1	C_ALIAS	249
6.11.1.2	C_ARG	249
6.11.1.3	C_AUTO	249
6.11.1.4	C_AUTOARG	249
6.11.1.5	C_BCOMM	249
6.11.1.6	C_BINCL	249
6.11.1.7	C_BLOCK	249
6.11.1.8	C_BSTAT	249
6.11.1.9	C_DECL	249
6.11.1.10	C_DEFINE	249
6.11.1.11	C_ECOML	249

6.11.1.12 C_ECOMM . . . . .	249
6.11.1.13 C_EFCN . . . . .	249
6.11.1.14 C_EINCL . . . . .	249
6.11.1.15 C_ENTAG . . . . .	249
6.11.1.16 C_ENTRY . . . . .	249
6.11.1.17 C_EOS . . . . .	249
6.11.1.18 C_ESTAT . . . . .	249
6.11.1.19 C_EXT . . . . .	249
6.11.1.20 C_EXTDEF . . . . .	249
6.11.1.21 C_EXTLAB . . . . .	249
6.11.1.22 C_FCN . . . . .	249
6.11.1.23 C_FIELD . . . . .	249
6.11.1.24 C_FILE . . . . .	249
6.11.1.25 C_FUN . . . . .	249
6.11.1.26 C_GSYM . . . . .	249
6.11.1.27 C_HIDDEN . . . . .	249
6.11.1.28 C_HIDEXT . . . . .	249
6.11.1.29 C_LABEL . . . . .	249
6.11.1.30 C_LASTENT . . . . .	249
6.11.1.31 C_LEAFEXT . . . . .	249
6.11.1.32 C_LEAFPROC . . . . .	249
6.11.1.33 C_LEAFSTAT . . . . .	249
6.11.1.34 C_LINE . . . . .	249
6.11.1.35 C_LSYM . . . . .	249
6.11.1.36 C_MOE . . . . .	249
6.11.1.37 C_MOS . . . . .	249
6.11.1.38 C_MOU . . . . .	249
6.11.1.39 C_NT_WEAK . . . . .	249
6.11.1.40 C_NULL . . . . .	249
6.11.1.41 C_OPTVAR . . . . .	249
6.11.1.42 C_PRAGMA . . . . .	249
6.11.1.43 C_PSYM . . . . .	249
6.11.1.44 C_REG . . . . .	249
6.11.1.45 C_REGPARM . . . . .	249
6.11.1.46 C_RPSYM . . . . .	249
6.11.1.47 C_RSYM . . . . .	249

---

6.11.1.48 C_SCALL . . . . .	249
6.11.1.49 C_SECTION . . . . .	249
6.11.1.50 C_SEGMENT . . . . .	249
6.11.1.51 C_SHADOW . . . . .	249
6.11.1.52 C_STAT . . . . .	249
6.11.1.53 C_STATLAB . . . . .	249
6.11.1.54 C_STRTAG . . . . .	249
6.11.1.55 C_STSYM . . . . .	249
6.11.1.56 C_SYSTEM . . . . .	249
6.11.1.57 C_TCSYM . . . . .	249
6.11.1.58 C_THUMBEXT . . . . .	249
6.11.1.59 C_THUMBEXTFUNC . . . . .	249
6.11.1.60 C_THUMBLABEL . . . . .	249
6.11.1.61 C_THUMBSTAT . . . . .	249
6.11.1.62 C_THUMBSTATFUNC . . . . .	249
6.11.1.63 C_TPDEF . . . . .	249
6.11.1.64 C_UEXT . . . . .	249
6.11.1.65 C_ULABEL . . . . .	249
6.11.1.66 C_UNTAG . . . . .	249
6.11.1.67 C_USTATIC . . . . .	249
6.11.1.68 C_VERSION . . . . .	249
6.11.1.69 C_WEAKEXT . . . . .	249
6.11.1.70 COFF_AOUTSZ . . . . .	249
6.11.1.71 COFF_AUXENT . . . . .	249
6.11.1.72 COFF_AUXESZ . . . . .	249
6.11.1.73 COFF_BSS . . . . .	249
6.11.1.74 COFF_COMMENT . . . . .	249
6.11.1.75 COFF_DATA . . . . .	249
6.11.1.76 COFF_DEF_BSS_SECTION_ALIGNMENT . . . . .	249
6.11.1.77 COFF_DEF_DATA_SECTION_ALIGNMENT . . . . .	249
6.11.1.78 COFF_DEF_SECTION_ALIGNMENT . . . . .	249
6.11.1.79 COFF_DEF_TEXT_SECTION_ALIGNMENT . . . . .	249
6.11.1.80 COFF_DMAGIC . . . . .	249
6.11.1.81 COFF_E_DIMNUM . . . . .	249
6.11.1.82 COFF_E_FILNMLEN . . . . .	249
6.11.1.83 COFF_E_SYMNMLEN . . . . .	249

---

6.11.1.84	COFF_ETEXT	249
6.11.1.85	COFF_F_AR16WR	249
6.11.1.86	COFF_F_AR32W	249
6.11.1.87	COFF_F_AR32WR	249
6.11.1.88	COFF_F_EXEC	249
6.11.1.89	COFF_F_LNNO	249
6.11.1.90	COFF_F_LSYMS	249
6.11.1.91	COFF_F_MINMAL	249
6.11.1.92	COFF_F_NODF	249
6.11.1.93	COFF_F_PATCH	249
6.11.1.94	COFF_F_RELFLG	249
6.11.1.95	COFF_F_SWABD	249
6.11.1.96	COFF_F_UPDATE	249
6.11.1.97	COFF_FILHDR	249
6.11.1.98	COFF_FILHSZ	249
6.11.1.99	COFF_I386BADMAG	249
6.11.1.100	COFF_I386MAGIC	249
6.11.1.101	COFF_JMAGIC	249
6.11.1.102	COFF_LIB	249
6.11.1.103	COFF_LINENO	249
6.11.1.104	COFF_LINESZ	249
6.11.1.105	COFF_LONG	249
6.11.1.106	COFF_LONG_H	249
6.11.1.107	COFF_LONG_L	249
6.11.1.108	COFF_N_BTMASK	249
6.11.1.109	COFF_N_BTSHFT	249
6.11.1.110	COFF_N_TMASK	249
6.11.1.111	COFF_N_TSHIFT	249
6.11.1.112	COFF_OMAGIC	249
6.11.1.113	COFF_RELOC	249
6.11.1.114	COFF_RELSZ	249
6.11.1.115	COFF_SCNHDR	249
6.11.1.116	COFF_SCNHSZ	249
6.11.1.117	COFF_SECT_BSS	249
6.11.1.118	COFF_SECT_DATA	249
6.11.1.119	COFF_SECT_REQD	249

6.11.1.120	COFF_SECT_TEXT	249
6.11.1.121	COFF_SHMAGIC	249
6.11.1.122	COFF_SHORT	249
6.11.1.123	COFF_SHORT_H	249
6.11.1.124	COFF_SHORT_L	249
6.11.1.125	COFF_SLIBHD	249
6.11.1.126	COFF_SLIBSZ	249
6.11.1.127	COFF_STMAGIC	249
6.11.1.128	COFF_STYP_BSS	249
6.11.1.129	COFF_STYP_COPY	249
6.11.1.130	COFF_STYP_DATA	249
6.11.1.131	COFF_STYP_DSECT	249
6.11.1.132	COFF_STYP_GROUP	249
6.11.1.133	COFF_STYP_INFO	249
6.11.1.134	COFF_STYP_LIB	249
6.11.1.135	COFF_STYP_NOLOAD	249
6.11.1.136	COFF_STYP_OVER	249
6.11.1.137	COFF_STYP_PAD	249
6.11.1.138	COFF_STYP_REG	249
6.11.1.139	COFF_STYP_TEXT	249
6.11.1.140	COFF_SYMENT	249
6.11.1.141	COFF_SYMESZ	249
6.11.1.142	COFF_TEXT	249
6.11.1.143	COFF_ZMAGIC	249
6.11.1.144	E_DIMNUM	249
6.11.1.145	E_FILNMLEN	249
6.11.1.146	E_SYMNMLEN	249
6.11.1.147	KEEP_ENDIAN_LONG	249
6.11.1.148	KEEP_ENDIAN_SHORT	250
6.11.1.149	SWAP_ENDIAN_LONG	250
6.11.1.150	SWAP_ENDIAN_SHORT	250
6.12	cpu/common/elf.h File Reference	251
6.12.1	Define Documentation	257
6.12.1.1	AT_BASE	257
6.12.1.2	AT_EGID	257
6.12.1.3	AT_ENTRY	257



---

6.12.1.4	AT_EUID	257
6.12.1.5	AT_EXECFD	257
6.12.1.6	AT_FLAGS	257
6.12.1.7	AT_GID	257
6.12.1.8	AT_IGNORE	257
6.12.1.9	AT_NOTELF	257
6.12.1.10	AT_NULL	257
6.12.1.11	AT_PAGESZ	257
6.12.1.12	AT_PHDR	257
6.12.1.13	AT_PHENT	257
6.12.1.14	AT_PHNUM	257
6.12.1.15	AT_UID	257
6.12.1.16	DT_DEBUG	257
6.12.1.17	DT_FINI	257
6.12.1.18	DT_HASH	257
6.12.1.19	DT_HIPROC	257
6.12.1.20	DT_INIT	257
6.12.1.21	DT_JMPREL	257
6.12.1.22	DT_LOPROC	257
6.12.1.23	DT_NEEDED	257
6.12.1.24	DT_NULL	257
6.12.1.25	DT_PLTGOT	257
6.12.1.26	DT_PLTREL	257
6.12.1.27	DT_PLTRELSZ	257
6.12.1.28	DT_REL	257
6.12.1.29	DT_RELA	257
6.12.1.30	DT_RELAENT	257
6.12.1.31	DT_RELASZ	257
6.12.1.32	DT_RELENT	257
6.12.1.33	DT_RELSZ	257
6.12.1.34	DT_RPATH	257
6.12.1.35	DT_SONAME	257
6.12.1.36	DT_STRSZ	257
6.12.1.37	DT_STRTAB	257
6.12.1.38	DT_SYMBOLIC	257
6.12.1.39	DT_SYMENT	257

---

6.12.1.40 DT_SYMTAB . . . . .	257
6.12.1.41 DT_TEXTREL . . . . .	257
6.12.1.42 EI_CLASS . . . . .	257
6.12.1.43 EI_DATA . . . . .	257
6.12.1.44 EI_MAG0 . . . . .	257
6.12.1.45 EI_MAG1 . . . . .	257
6.12.1.46 EI_MAG2 . . . . .	257
6.12.1.47 EI_MAG3 . . . . .	257
6.12.1.48 EI_NIDENT . . . . .	257
6.12.1.49 EI_PAD . . . . .	257
6.12.1.50 EI_VERSION . . . . .	257
6.12.1.51 ELF32_R_SYM . . . . .	257
6.12.1.52 ELF32_R_TYPE . . . . .	257
6.12.1.53 ELF32_ST_BIND . . . . .	257
6.12.1.54 ELF32_ST_TYPE . . . . .	257
6.12.1.55 ELF_LONG_H . . . . .	257
6.12.1.56 elf_note . . . . .	258
6.12.1.57 elf_phdr . . . . .	258
6.12.1.58 ELF_SHORT_H . . . . .	258
6.12.1.59 ELFCLASS32 . . . . .	260
6.12.1.60 ELFCLASS64 . . . . .	260
6.12.1.61 ELFCLASSNONE . . . . .	260
6.12.1.62 ELFCLASSNUM . . . . .	260
6.12.1.63 ELFDATA2LSB . . . . .	260
6.12.1.64 ELFDATA2MSB . . . . .	260
6.12.1.65 ELFDATANONE . . . . .	260
6.12.1.66 elfhdr . . . . .	260
6.12.1.67 ELFMAG . . . . .	260
6.12.1.68 ELFMAG0 . . . . .	260
6.12.1.69 ELFMAG1 . . . . .	260
6.12.1.70 ELFMAG2 . . . . .	260
6.12.1.71 ELFMAG3 . . . . .	260
6.12.1.72 EM_386 . . . . .	260
6.12.1.73 EM_486 . . . . .	260
6.12.1.74 EM_68K . . . . .	260
6.12.1.75 EM_860 . . . . .	260

---

6.12.1.76 EM_88K . . . . .	260
6.12.1.77 EM_ALPHA . . . . .	260
6.12.1.78 EM_M32 . . . . .	260
6.12.1.79 EM_MIPS . . . . .	260
6.12.1.80 EM_MIPS_RS4_BE . . . . .	260
6.12.1.81 EM_NONE . . . . .	260
6.12.1.82 EM_PARISC . . . . .	260
6.12.1.83 EM_PPC . . . . .	260
6.12.1.84 EM_SPARC . . . . .	260
6.12.1.85 EM_SPARC32PLUS . . . . .	260
6.12.1.86 EM_SPARC64 . . . . .	260
6.12.1.87 ET_CORE . . . . .	260
6.12.1.88 ET_DYN . . . . .	260
6.12.1.89 ET_EXEC . . . . .	260
6.12.1.90 ET_HIPROC . . . . .	260
6.12.1.91 ET_LOPROC . . . . .	260
6.12.1.92 ET_NONE . . . . .	260
6.12.1.93 ET_REL . . . . .	260
6.12.1.94 EV_CURRENT . . . . .	260
6.12.1.95 EV_NONE . . . . .	260
6.12.1.96 EV_NUM . . . . .	260
6.12.1.97 NT_PRFPREG . . . . .	260
6.12.1.98 NT_PRPSINFO . . . . .	260
6.12.1.99 NT_PRSTATUS . . . . .	260
6.12.1.100 NT_TASKSTRUCT . . . . .	260
6.12.1.101 PF_R . . . . .	260
6.12.1.102 PF_W . . . . .	260
6.12.1.103 PF_X . . . . .	260
6.12.1.104 PT_DYNAMIC . . . . .	260
6.12.1.105 PT_HIPROC . . . . .	260
6.12.1.106 PT_INTERP . . . . .	260
6.12.1.107 PT_LOAD . . . . .	260
6.12.1.108 PT_LOPROC . . . . .	260
6.12.1.109 PT_NOTE . . . . .	260
6.12.1.110 PT_NULL . . . . .	260
6.12.1.111 PT_PHDR . . . . .	260

---

6.12.1.112PT_SHLIB . . . . .	260
6.12.1.113R_386_32 . . . . .	260
6.12.1.114R_386_COPY . . . . .	260
6.12.1.115R_386_GLOB_DAT . . . . .	260
6.12.1.116R_386_GOT32 . . . . .	260
6.12.1.117R_386_GOTOFF . . . . .	260
6.12.1.118R_386_GOTPC . . . . .	260
6.12.1.119R_386_JMP_SLOT . . . . .	260
6.12.1.120R_386_NONE . . . . .	260
6.12.1.121R_386_NUM . . . . .	260
6.12.1.122R_386_PC32 . . . . .	260
6.12.1.123R_386_PLT32 . . . . .	260
6.12.1.124R_386_RELATIVE . . . . .	260
6.12.1.125R_68K_16 . . . . .	260
6.12.1.126R_68K_32 . . . . .	260
6.12.1.127R_68K_8 . . . . .	260
6.12.1.128R_68K_COPY . . . . .	260
6.12.1.129R_68K_GLOB_DAT . . . . .	260
6.12.1.130R_68K_GOT16 . . . . .	260
6.12.1.131R_68K_GOT16O . . . . .	260
6.12.1.132R_68K_GOT32 . . . . .	260
6.12.1.133R_68K_GOT32O . . . . .	260
6.12.1.134R_68K_GOT8 . . . . .	260
6.12.1.135R_68K_GOT8O . . . . .	260
6.12.1.136R_68K_JMP_SLOT . . . . .	260
6.12.1.137R_68K_NONE . . . . .	260
6.12.1.138R_68K_PC16 . . . . .	260
6.12.1.139R_68K_PC32 . . . . .	260
6.12.1.140R_68K_PC8 . . . . .	260
6.12.1.141R_68K_PLT16 . . . . .	260
6.12.1.142R_68K_PLT16O . . . . .	260
6.12.1.143R_68K_PLT32 . . . . .	260
6.12.1.144R_68K_PLT32O . . . . .	260
6.12.1.145R_68K_PLT8 . . . . .	260
6.12.1.146R_68K_PLT8O . . . . .	260
6.12.1.147R_68K_RELATIVE . . . . .	260

---

6.12.1.148	SELMAG	260
6.12.1.149	SHF_ALLOC	260
6.12.1.150	SHF_EXECINSTR	260
6.12.1.151	SHF_MASKPROC	260
6.12.1.152	SHF_WRITE	260
6.12.1.153	SHN_ABS	260
6.12.1.154	SHN_COMMON	260
6.12.1.155	SHN_HIPROC	260
6.12.1.156	SHN_HIRESERVE	260
6.12.1.157	SHN_LOPROC	260
6.12.1.158	SHN_LORESERVE	260
6.12.1.159	SHN_UNDEF	260
6.12.1.160	SHT_DYNAMIC	260
6.12.1.161	SHT_DYNSYM	260
6.12.1.162	SHT_HASH	260
6.12.1.163	SHT_HIPROC	260
6.12.1.164	SHT_HIUSER	260
6.12.1.165	SHT_LOPROC	260
6.12.1.166	SHT_LOUSER	260
6.12.1.167	SHT_NOBITS	260
6.12.1.168	SHT_NOTE	260
6.12.1.169	SHT_NULL	260
6.12.1.170	SHT_NUM	260
6.12.1.171	SHT_PROGBITS	260
6.12.1.172	SHT_REL	260
6.12.1.173	SHT_RELA	260
6.12.1.174	SHT_SHLIB	260
6.12.1.175	SHT_STRTAB	260
6.12.1.176	SHT_SYMTAB	260
6.12.1.177	STB_GLOBAL	260
6.12.1.178	STB_LOCAL	260
6.12.1.179	STB_WEAK	260
6.12.1.180	STT_FILE	260
6.12.1.181	STT_FUNC	260
6.12.1.182	STT_NOTYPE	260
6.12.1.183	STT_OBJECT	260

6.12.1.18	STT_SECTION	260
6.12.2	Typedef Documentation	260
6.12.2.1	Elf32_Addr	260
6.12.2.2	Elf32_Dyn	260
6.12.2.3	Elf32_Ehdr	260
6.12.2.4	Elf32_Half	260
6.12.2.5	Elf32_Nhdr	260
6.12.2.6	Elf32_Off	260
6.12.2.7	Elf32_Phdr	260
6.12.2.8	Elf32_Rel	260
6.12.2.9	Elf32_Rela	260
6.12.2.10	Elf32_Shdr	260
6.12.2.11	Elf32_Sword	260
6.12.2.12	Elf32_Sym	260
6.12.2.13	Elf32_Word	260
6.12.2.14	Elf64_Ehdr	260
6.12.2.15	Elf64_Nhdr	260
6.12.2.16	Elf64_Phdr	260
6.12.2.17	Elf64_Rel	260
6.12.2.18	Elf64_Rela	260
6.12.2.19	Elf64_Shdr	260
6.12.2.20	Elf64_Sym	260
6.12.3	Variable Documentation	260
6.12.3.1	_DYNAMIC	260
6.13	cpu/common/execute.h File Reference	261
6.13.1	Define Documentation	262
6.13.1.1	CURINSN	262
6.13.1.2	SET_OV_FLAG_FN	262
6.13.2	Function Documentation	262
6.13.2.1	analysis	262
6.13.2.2	cpu_clock	263
6.13.2.3	cpu_reset	263
6.13.2.4	depend_operands	263
6.13.2.5	dump_exe_log	263
6.13.2.6	dumpreg	264
6.13.2.7	eval_operand_val	264

---

6.13.2.8	evalsim_reg	265
6.13.2.9	exec_main	265
6.13.2.10	setsim_reg	267
6.13.3	Variable Documentation	267
6.13.3.1	cpu_state	267
6.13.3.2	do_stats	267
6.13.3.3	hist_exec_tail	267
6.13.3.4	pcnext	267
6.13.3.5	sbuf_total_cyc	267
6.13.3.6	sbuf_wait_cyc	267
6.14	cpu/common/labels.c File Reference	268
6.14.1	Define Documentation	269
6.14.1.1	LABELS_HASH_SIZE	269
6.14.2	Function Documentation	269
6.14.2.1	add_breakpoint	269
6.14.2.2	add_label	269
6.14.2.3	eval_label	269
6.14.2.4	find_label	269
6.14.2.5	get_label	269
6.14.2.6	has_breakpoint	269
6.14.2.7	init_breakpoints	269
6.14.2.8	init_labels	269
6.14.2.9	print_breakpoints	269
6.14.2.10	remove_breakpoint	269
6.14.3	Variable Documentation	269
6.14.3.1	breakpoints	269
6.14.3.2	label_hash	269
6.15	cpu/common/labels.h File Reference	270
6.15.1	Function Documentation	271
6.15.1.1	add_breakpoint	271
6.15.1.2	add_label	271
6.15.1.3	eval_label	271
6.15.1.4	find_label	271
6.15.1.5	get_label	271
6.15.1.6	has_breakpoint	271
6.15.1.7	init_breakpoints	271

6.15.1.8	init_labels	271
6.15.1.9	print_breakpoints	271
6.15.1.10	remove_breakpoint	271
6.15.2	Variable Documentation	271
6.15.2.1	breakpoints	271
6.16	cpu/common/parse.c File Reference	272
6.16.1	Define Documentation	273
6.16.1.1	IMM_STATS	273
6.16.1.2	MEMORY_LEN	273
6.16.2	Function Documentation	273
6.16.2.1	addprogram	273
6.16.2.2	identifyfile	274
6.16.2.3	loadcode	274
6.16.2.4	readfile_coff	275
6.16.2.5	readfile_elf	276
6.16.2.6	readsyms_coff	276
6.16.2.7	rstrip	276
6.16.2.8	translate	276
6.16.3	Variable Documentation	277
6.16.3.1	freemem	277
6.16.3.2	transl_error	277
6.16.3.3	transl_table	277
6.17	cpu/common/parse.h File Reference	278
6.17.1	Function Documentation	278
6.17.1.1	loadcode	278
6.17.1.2	rstrip	279
6.18	cpu/common/stats.c File Reference	280
6.18.1	Define Documentation	281
6.18.1.1	DSTATS_LEN	281
6.18.1.2	FSTATS_LEN	281
6.18.1.3	SD	281
6.18.1.4	SSTATS_LEN	281
6.18.2	Function Documentation	281
6.18.2.1	addstats	281
6.18.2.2	addfstats	281
6.18.2.3	addsstats	281



---

6.18.2.4	initstats	281
6.18.2.5	printotherstats	281
6.18.2.6	printstats	281
6.18.3	Variable Documentation	282
6.18.3.1	dc_stats	282
6.18.3.2	dmmu_stats	282
6.18.3.3	dstats	282
6.18.3.4	fstats	282
6.18.3.5	func_unit_str	282
6.18.3.6	ic_stats	282
6.18.3.7	immu_stats	282
6.18.3.8	or1k_mstats	283
6.18.3.9	raw_stats	283
6.18.3.10	sstats	283
6.19	cpu/common/stats.h File Reference	284
6.19.1	Define Documentation	285
6.19.1.1	RAW_RANGE	285
6.19.2	Function Documentation	285
6.19.2.1	adddstats	285
6.19.2.2	addfstats	285
6.19.2.3	addsstats	285
6.19.2.4	initstats	285
6.19.2.5	printstats	285
6.19.3	Variable Documentation	285
6.19.3.1	dc_stats	285
6.19.3.2	dmmu_stats	285
6.19.3.3	ic_stats	285
6.19.3.4	immu_stats	285
6.19.3.5	or1k_mstats	285
6.19.3.6	raw_stats	285
6.20	cpu/common/trace.c File Reference	286
6.20.1	Function Documentation	286
6.20.1.1	set_insbrkpoint	286
6.21	cpu/common/trace.h File Reference	288
6.21.1	Function Documentation	288
6.21.1.1	set_insbrkpoint	288

---

6.22	cpu/or1k/arch.h File Reference	290
6.22.1	Define Documentation	290
6.22.1.1	ADDR_C	290
6.22.1.2	LINK_REGNO	290
6.22.1.3	PRIdREG	290
6.22.1.4	PRIxADDR	291
6.22.1.5	PRIxREG	291
6.22.1.6	REG_C	291
6.22.2	Typedef Documentation	291
6.22.2.1	oraddr_t	291
6.22.2.2	orreg_t	291
6.22.2.3	uorreg_t	291
6.23	cpu/or1k/except.c File Reference	292
6.23.1	Function Documentation	293
6.23.1.1	except_handle	293
6.23.1.2	op_join_mem_cycles	293
6.23.2	Variable Documentation	293
6.23.2.1	except_pending	293
6.24	cpu/or1k/except.h File Reference	294
6.24.1	Define Documentation	296
6.24.1.1	EXCEPT_ALIGN	296
6.24.1.2	EXCEPT_BUSERR	296
6.24.1.3	EXCEPT_DPF	296
6.24.1.4	EXCEPT_DTLBMISS	296
6.24.1.5	EXCEPT_FPE	296
6.24.1.6	EXCEPT_ILLEGAL	296
6.24.1.7	EXCEPT_INT	296
6.24.1.8	EXCEPT_IPF	296
6.24.1.9	EXCEPT_ITLBMISS	296
6.24.1.10	EXCEPT_NONE	296
6.24.1.11	EXCEPT_RANGE	296
6.24.1.12	EXCEPT_RESET	296
6.24.1.13	EXCEPT_SYSCALL	296
6.24.1.14	EXCEPT_TICK	296
6.24.1.15	EXCEPT_TRAP	296
6.24.2	Function Documentation	296

---

6.24.2.1	except_handle	296
6.24.3	Variable Documentation	297
6.24.3.1	except_pending	297
6.25	cpu/or1k/spr-defs.h File Reference	298
6.25.1	Define Documentation	305
6.25.1.1	MATCHPOINTS_TO_NDP	305
6.25.1.2	MAX_GRPS	307
6.25.1.3	MAX_MATCHPOINTS	307
6.25.1.4	MAX_SPRS	307
6.25.1.5	MAX_SPRS_PER_GRP	307
6.25.1.6	MAX_SPRS_PER_GRP_BITS	307
6.25.1.7	MAX_WATCHPOINTS	307
6.25.1.8	NOP_CNT_RESET	307
6.25.1.9	NOP_EXIT	307
6.25.1.10	NOP_NOP	307
6.25.1.11	NOP_PRINTF	307
6.25.1.12	NOP_PUTC	307
6.25.1.13	NOP_REPORT	307
6.25.1.14	NOP_REPORT_FIRST	307
6.25.1.15	NOP_REPORT_LAST	307
6.25.1.16	SPR_CPUCFGR	307
6.25.1.17	SPR_CPUCFGR_CGF	307
6.25.1.18	SPR_CPUCFGR_NSGF	307
6.25.1.19	SPR_CPUCFGR_OB32S	307
6.25.1.20	SPR_CPUCFGR_OB64S	307
6.25.1.21	SPR_CPUCFGR_OF32S	307
6.25.1.22	SPR_CPUCFGR_OF64S	307
6.25.1.23	SPR_CPUCFGR_OV64S	307
6.25.1.24	SPR_CPUCFGR_RES	307
6.25.1.25	SPR_DCBFR	307
6.25.1.26	SPR_DCBIR	307
6.25.1.27	SPR_DCBLR	307
6.25.1.28	SPR_DCBPR	307
6.25.1.29	SPR_DCBWR	307
6.25.1.30	SPR_DCCFGR	307
6.25.1.31	SPR_DCCFGR_CBFRI	307

---

6.25.1.32 SPR_DCCFGR_CBIRI	307
6.25.1.33 SPR_DCCFGR_CBLRI	307
6.25.1.34 SPR_DCCFGR_CBPRI	307
6.25.1.35 SPR_DCCFGR_CBS	307
6.25.1.36 SPR_DCCFGR_CBS_OFF	307
6.25.1.37 SPR_DCCFGR_CBWBRI	307
6.25.1.38 SPR_DCCFGR_CCRI	307
6.25.1.39 SPR_DCCFGR_CWS	307
6.25.1.40 SPR_DCCFGR_NCS	307
6.25.1.41 SPR_DCCFGR_NCS_OFF	307
6.25.1.42 SPR_DCCFGR_NCW	307
6.25.1.43 SPR_DCCFGR_NCW_OFF	307
6.25.1.44 SPR_DCCR	307
6.25.1.45 SPR_DCCR_EW	307
6.25.1.46 SPR_DCFGR	307
6.25.1.47 SPR_DCFGR_NDP	307
6.25.1.48 SPR_DCFGR_NDP1	307
6.25.1.49 SPR_DCFGR_NDP2	307
6.25.1.50 SPR_DCFGR_NDP3	307
6.25.1.51 SPR_DCFGR_NDP4	307
6.25.1.52 SPR_DCFGR_NDP5	307
6.25.1.53 SPR_DCFGR_NDP6	307
6.25.1.54 SPR_DCFGR_NDP7	307
6.25.1.55 SPR_DCFGR_NDP8	307
6.25.1.56 SPR_DCFGR_WPCI	307
6.25.1.57 SPR_DCR	307
6.25.1.58 SPR_DCR_BASE	307
6.25.1.59 SPR_DCR_CC	307
6.25.1.60 SPR_DCR_CC_EQUAL	307
6.25.1.61 SPR_DCR_CC_GREAT	307
6.25.1.62 SPR_DCR_CC_GREATER	307
6.25.1.63 SPR_DCR_CC_LESS	307
6.25.1.64 SPR_DCR_CC_LESSE	307
6.25.1.65 SPR_DCR_CC_MASKED	307
6.25.1.66 SPR_DCR_CC_NEQUAL	307
6.25.1.67 SPR_DCR_CT	307

---

6.25.1.68	SPR_DCR_CT_DISABLED	307
6.25.1.69	SPR_DCR_CT_IFEA	307
6.25.1.70	SPR_DCR_CT_LD	307
6.25.1.71	SPR_DCR_CT_LEA	307
6.25.1.72	SPR_DCR_CT_LSD	307
6.25.1.73	SPR_DCR_CT_LSEA	307
6.25.1.74	SPR_DCR_CT_SD	307
6.25.1.75	SPR_DCR_CT_SEA	307
6.25.1.76	SPR_DCR_DP	307
6.25.1.77	SPR_DCR_LAST	307
6.25.1.78	SPR_DCR_SC	307
6.25.1.79	SPR_DMMUCFGR	307
6.25.1.80	SPR_DMMUCFGR_CRI	307
6.25.1.81	SPR_DMMUCFGR_HTR	307
6.25.1.82	SPR_DMMUCFGR_NAE	307
6.25.1.83	SPR_DMMUCFGR_NTS	307
6.25.1.84	SPR_DMMUCFGR_NTS_OFF	307
6.25.1.85	SPR_DMMUCFGR_NTW	307
6.25.1.86	SPR_DMMUCFGR_NTW_OFF	307
6.25.1.87	SPR_DMMUCFGR_PRI	307
6.25.1.88	SPR_DMMUCFGR_TEIRI	307
6.25.1.89	SPR_DMMUCR	307
6.25.1.90	SPR_DMMUCR_P1S	307
6.25.1.91	SPR_DMMUCR_P2S	307
6.25.1.92	SPR_DMMUCR_PADDR_WIDTH	307
6.25.1.93	SPR_DMMUCR_VADDR_WIDTH	307
6.25.1.94	SPR_DMR1	307
6.25.1.95	SPR_DMR1_BT	307
6.25.1.96	SPR_DMR1_CW	307
6.25.1.97	SPR_DMR1_CW0	307
6.25.1.98	SPR_DMR1_CW0_AND	307
6.25.1.99	SPR_DMR1_CW0_OR	307
6.25.1.100	SPR_DMR1_CW1	307
6.25.1.101	SPR_DMR1_CW1_AND	307
6.25.1.102	SPR_DMR1_CW1_OR	307
6.25.1.103	SPR_DMR1_CW2	307

---

6.25.1.104	SPR_DMR1_CW2_AND	307
6.25.1.105	SPR_DMR1_CW2_OR	307
6.25.1.106	SPR_DMR1_CW3	307
6.25.1.107	SPR_DMR1_CW3_AND	307
6.25.1.108	SPR_DMR1_CW3_OR	307
6.25.1.109	SPR_DMR1_CW4	307
6.25.1.110	SPR_DMR1_CW4_AND	307
6.25.1.111	SPR_DMR1_CW4_OR	307
6.25.1.112	SPR_DMR1_CW5	307
6.25.1.113	SPR_DMR1_CW5_AND	307
6.25.1.114	SPR_DMR1_CW5_OR	307
6.25.1.115	SPR_DMR1_CW6	307
6.25.1.116	SPR_DMR1_CW6_AND	307
6.25.1.117	SPR_DMR1_CW6_OR	307
6.25.1.118	SPR_DMR1_CW7	307
6.25.1.119	SPR_DMR1_CW7_AND	307
6.25.1.120	SPR_DMR1_CW7_OR	307
6.25.1.121	SPR_DMR1_CW8	307
6.25.1.122	SPR_DMR1_CW8_AND	307
6.25.1.123	SPR_DMR1_CW8_OR	307
6.25.1.124	SPR_DMR1_CW9	307
6.25.1.125	SPR_DMR1_CW9_AND	307
6.25.1.126	SPR_DMR1_CW9_OR	307
6.25.1.127	SPR_DMR1_RES1	307
6.25.1.128	SPR_DMR1_RES2	307
6.25.1.129	SPR_DMR1_ST	307
6.25.1.130	SPR_DMR2	307
6.25.1.131	SPR_DMR2_AWTC	307
6.25.1.132	SPR_DMR2_AWTC_OFF	307
6.25.1.133	SPR_DMR2_WBS	307
6.25.1.134	SPR_DMR2_WBS_OFF	307
6.25.1.135	SPR_DMR2_WCE0	307
6.25.1.136	SPR_DMR2_WCE1	307
6.25.1.137	SPR_DMR2_WGB	307
6.25.1.138	SPR_DMR2_WGB_OFF	307
6.25.1.139	SPR_DRR	307

---

6.25.1.140	SPR_DRR_AE	307
6.25.1.141	SPR_DRR_BUSEE	307
6.25.1.142	SPR_DRR_DME	307
6.25.1.143	SPR_DRR_DPFE	307
6.25.1.144	SPR_DRR_FPE	307
6.25.1.145	SPR_DRR_IE	307
6.25.1.146	SPR_DRR_IIE	307
6.25.1.147	SPR_DRR_IME	307
6.25.1.148	SPR_DRR_IPFE	307
6.25.1.149	SPR_DRR_RE	307
6.25.1.150	SPR_DRR_RSTE	307
6.25.1.151	SPR_DRR_SCE	307
6.25.1.152	SPR_DRR_TE	307
6.25.1.153	SPR_DRR_TTE	307
6.25.1.154	SPR_DSR	307
6.25.1.155	SPR_DSR_AE	307
6.25.1.156	SPR_DSR_BUSEE	307
6.25.1.157	SPR_DSR_DME	307
6.25.1.158	SPR_DSR_DPFE	307
6.25.1.159	SPR_DSR_FPE	307
6.25.1.160	SPR_DSR_IE	307
6.25.1.161	SPR_DSR_IIE	307
6.25.1.162	SPR_DSR_IME	307
6.25.1.163	SPR_DSR_IPFE	307
6.25.1.164	SPR_DSR_RE	307
6.25.1.165	SPR_DSR_RSTE	307
6.25.1.166	SPR_DSR_SCE	307
6.25.1.167	SPR_DSR_TE	307
6.25.1.168	SPR_DSR_TTE	307
6.25.1.169	SPR_DTLBMR_BASE	307
6.25.1.170	SPR_DTLBMR_CID	307
6.25.1.171	SPR_DTLBMR_LAST	307
6.25.1.172	SPR_DTLBMR_LRU	307
6.25.1.173	SPR_DTLBMR_PL1	307
6.25.1.174	SPR_DTLBMR_V	307
6.25.1.175	SPR_DTLBMR_VPN	307

---

6.25.1.176	SPR_DTLBTR_A	307
6.25.1.177	SPR_DTLBTR_BASE	307
6.25.1.178	SPR_DTLBTR_CC	307
6.25.1.179	SPR_DTLBTR_CI	307
6.25.1.180	SPR_DTLBTR_D	307
6.25.1.181	SPR_DTLBTR_LAST	307
6.25.1.182	SPR_DTLBTR_PPN	307
6.25.1.183	SPR_DTLBTR_SRE	307
6.25.1.184	SPR_DTLBTR_SWE	307
6.25.1.185	SPR_DTLBTR_URE	307
6.25.1.186	SPR_DTLBTR_UWE	307
6.25.1.187	SPR_DTLBTR_WBC	307
6.25.1.188	SPR_DTLBTR_WOM	307
6.25.1.189	SPR_DVR	307
6.25.1.190	SPR_DWCR0	307
6.25.1.191	SPR_DWCR1	307
6.25.1.192	SPR_DWCR_COUNT	307
6.25.1.193	SPR_DWCR_MATCH	307
6.25.1.194	SPR_DWCR_MATCH_OFF	307
6.25.1.195	SPR_EEAR_BASE	307
6.25.1.196	SPR_EEAR_LAST	307
6.25.1.197	SPR_EPCR_BASE	307
6.25.1.198	SPR_EPCR_LAST	307
6.25.1.199	SPR_ESR_BASE	307
6.25.1.200	SPR_ESR_LAST	307
6.25.1.201	SPR_ICBIR	307
6.25.1.202	SPR_ICBLR	307
6.25.1.203	SPR_ICBPR	307
6.25.1.204	SPR_ICCFGR	307
6.25.1.205	SPR_ICCFGR_CBIRI	307
6.25.1.206	SPR_ICCFGR_CBLRI	307
6.25.1.207	SPR_ICCFGR_CBPRI	307
6.25.1.208	SPR_ICCFGR_CBS	307
6.25.1.209	SPR_ICCFGR_CBS_OFF	307
6.25.1.210	SPR_ICCFGR_CCRI	307
6.25.1.211	SPR_ICCFGR_NCS	307



6.25.1.212	SPR_ICCFGR_NCS_OFF	307
6.25.1.213	SPR_ICCFGR_NCW	307
6.25.1.214	SPR_ICCFGR_NCW_OFF	307
6.25.1.215	SPR_ICCR	307
6.25.1.216	SPR_ICCR_EW	307
6.25.1.217	SPR_ICR_BASE	307
6.25.1.218	SPR_ICR_LAST	307
6.25.1.219	SPR_IMMUCFGR	307
6.25.1.220	SPR_IMMUCFGR_CRI	307
6.25.1.221	SPR_IMMUCFGR_HTR	307
6.25.1.222	SPR_IMMUCFGR_NAE	307
6.25.1.223	SPR_IMMUCFGR_NTS	307
6.25.1.224	SPR_IMMUCFGR_NTS_OFF	307
6.25.1.225	SPR_IMMUCFGR_NTW	307
6.25.1.226	SPR_IMMUCFGR_NTW_OFF	307
6.25.1.227	SPR_IMMUCFGR_PRI	307
6.25.1.228	SPR_IMMUCFGR_TEIRI	307
6.25.1.229	SPR_IMMUCR	307
6.25.1.230	SPR_IMMUCR_P1S	307
6.25.1.231	SPR_IMMUCR_P2S	307
6.25.1.232	SPR_IMMUCR_PADDR_WIDTH	307
6.25.1.233	SPR_IMMUCR_VADDR_WIDTH	307
6.25.1.234	SPR_ITLBMR_BASE	307
6.25.1.235	SPR_ITLBMR_CID	307
6.25.1.236	SPR_ITLBMR_LAST	307
6.25.1.237	SPR_ITLBMR_LRU	307
6.25.1.238	SPR_ITLBMR_PL1	307
6.25.1.239	SPR_ITLBMR_V	307
6.25.1.240	SPR_ITLBMR_VPN	307
6.25.1.241	SPR_ITLBTR_A	307
6.25.1.242	SPR_ITLBTR_BASE	307
6.25.1.243	SPR_ITLBTR_CC	307
6.25.1.244	SPR_ITLBTR_CI	307
6.25.1.245	SPR_ITLBTR_D	307
6.25.1.246	SPR_ITLBTR_LAST	307
6.25.1.247	SPR_ITLBTR_PPN	307

---

6.25.1.248	SPR_ITLBTR_SXE	307
6.25.1.249	SPR_ITLBTR_UXE	307
6.25.1.250	SPR_ITLBTR_WBC	307
6.25.1.251	SPR_ITLBTR_WOM	307
6.25.1.252	SPR_MACHI	307
6.25.1.253	SPR_MACLO	307
6.25.1.254	SPR_NPC	307
6.25.1.255	SPR_PCCFGR	307
6.25.1.256	SPR_PCCR	307
6.25.1.257	SPR_PCMR	307
6.25.1.258	SPR_PCMR_BS	307
6.25.1.259	SPR_PCMR_CISM	307
6.25.1.260	SPR_PCMR_CIUM	307
6.25.1.261	SPR_PCMR_CP	307
6.25.1.262	SPR_PCMR_DCM	307
6.25.1.263	SPR_PCMR_DDS	307
6.25.1.264	SPR_PCMR_DTLBM	307
6.25.1.265	SPR_PCMR_ICM	307
6.25.1.266	SPR_PCMR_IF	307
6.25.1.267	SPR_PCMR_IFS	307
6.25.1.268	SPR_PCMR_ITLBM	307
6.25.1.269	SPR_PCMR_LA	307
6.25.1.270	SPR_PCMR_LSUS	307
6.25.1.271	SPR_PCMR_SA	307
6.25.1.272	SPR_PCMR_UMRA	307
6.25.1.273	SPR_PCMR_WPE	307
6.25.1.274	SPR_PICMR	307
6.25.1.275	SPR_PICMR_IUM	307
6.25.1.276	SPR_PICPR	307
6.25.1.277	SPR_PICPR_IPRIO	307
6.25.1.278	SPR_PICSR	307
6.25.1.279	SPR_PICSR_IS	307
6.25.1.280	SPR_PMR	307
6.25.1.281	SPR_PMR_DCGE	307
6.25.1.282	SPR_PMR_DME	307
6.25.1.283	SPR_PMR_SDF	307

---

6.25.1.284	SPR_PMR_SME	307
6.25.1.285	SPR_PMR_SUME	307
6.25.1.286	SPR_PPC	307
6.25.1.287	SPR_SR	307
6.25.1.288	SPR_SR_CE	307
6.25.1.289	SPR_SR_CID	307
6.25.1.290	SPR_SR_CY	307
6.25.1.291	SPR_SR_DCE	307
6.25.1.292	SPR_SR_DME	307
6.25.1.293	SPR_SR_DSX	307
6.25.1.294	SPR_SR_EPH	307
6.25.1.295	SPR_SR_F	307
6.25.1.296	SPR_SR_FO	307
6.25.1.297	SPR_SR_ICE	307
6.25.1.298	SPR_SR_IEE	307
6.25.1.299	SPR_SR_IME	307
6.25.1.300	SPR_SR_LEE	307
6.25.1.301	SPR_SR_OV	307
6.25.1.302	SPR_SR_OVE	307
6.25.1.303	SPR_SR_RES	307
6.25.1.304	SPR_SR_SM	307
6.25.1.305	SPR_SR_SUMRA	307
6.25.1.306	SPR_SR_TEE	307
6.25.1.307	SPR_TTCR	307
6.25.1.308	SPR_TTCR_PERIOD	307
6.25.1.309	SPR_TTMR	307
6.25.1.310	SPR_TTMR_CR	307
6.25.1.311	SPR_TTMR_IE	307
6.25.1.312	SPR_TTMR_IP	307
6.25.1.313	SPR_TTMR_M	307
6.25.1.314	SPR_TTMR_PERIOD	307
6.25.1.315	SPR_TTMR_RT	307
6.25.1.316	SPR_TTMR_SR	307
6.25.1.317	SPR_UPR	307
6.25.1.318	SPR_UPR_CUP	307
6.25.1.319	SPR_UPR_DCP	307

6.25.1.320	SPR_UPR_DMP	307
6.25.1.321	SPR_UPR_DUP	307
6.25.1.322	SPR_UPR_ICP	307
6.25.1.323	SPR_UPR_IMP	307
6.25.1.324	SPR_UPR_MP	307
6.25.1.325	SPR_UPR_PCUP	307
6.25.1.326	SPR_UPR_PICP	307
6.25.1.327	SPR_UPR_PMP	307
6.25.1.328	SPR_UPR_RES	307
6.25.1.329	SPR_UPR_TTP	307
6.25.1.330	SPR_UPR_UP	307
6.25.1.331	SPR_VR	307
6.25.1.332	SPR_VR_CFG	307
6.25.1.333	SPR_VR_CFG_OFF	307
6.25.1.334	SPR_VR_RES	307
6.25.1.335	SPR_VR_REV	307
6.25.1.336	SPR_VR_REV_OFF	307
6.25.1.337	SPR_VR_VER	307
6.25.1.338	SPR_VR_VER_OFF	307
6.25.1.339	SPRGROUP_D	307
6.25.1.340	SPRGROUP_DC	307
6.25.1.341	SPRGROUP_DMMU	307
6.25.1.342	SPRGROUP_IC	307
6.25.1.343	SPRGROUP_IMMU	307
6.25.1.344	SPRGROUP_MAC	307
6.25.1.345	SPRGROUP_PC	307
6.25.1.346	SPRGROUP_PIC	307
6.25.1.347	SPRGROUP_PM	307
6.25.1.348	SPRGROUP_SYS	307
6.25.1.349	SPRGROUP_TT	307
6.26	cpu/or1k/spr-dump.c File Reference	308
6.26.1	Function Documentation	309
6.26.1.1	dump_spr	309
6.26.2	Variable Documentation	309
6.26.2.1	ret_spr	309
6.26.2.2	spr_cpucfgr	309

---

6.26.2.3	spr_d_group	310
6.26.2.4	spr_dc_group	310
6.26.2.5	spr_dccfgr	310
6.26.2.6	spr_dccr	310
6.26.2.7	spr_dcfgr	311
6.26.2.8	spr_dmmu_group	311
6.26.2.9	spr_dmmucfgr	311
6.26.2.10	spr_dmmucr	311
6.26.2.11	spr_dmr1	312
6.26.2.12	spr_dmr2	312
6.26.2.13	spr_drr	312
6.26.2.14	spr_dsr	312
6.26.2.15	spr_dtlbmr	313
6.26.2.16	spr_dtlbtr	313
6.26.2.17	spr_dwcr	313
6.26.2.18	spr_groups	314
6.26.2.19	spr_ic_group	314
6.26.2.20	spr_icefgr	314
6.26.2.21	spr_iccr	314
6.26.2.22	spr_immu_group	315
6.26.2.23	spr_immucfgr	315
6.26.2.24	spr_immucr	315
6.26.2.25	spr_itlbmr	315
6.26.2.26	spr_itlbtr	316
6.26.2.27	spr_mac_group	316
6.26.2.28	spr_one_val	316
6.26.2.29	spr_pc_group	316
6.26.2.30	spr_pcmr	316
6.26.2.31	spr_pic_group	317
6.26.2.32	spr_picmr	317
6.26.2.33	spr_pm_group	317
6.26.2.34	spr_pmr	317
6.26.2.35	spr_sr	318
6.26.2.36	spr_sys_group	318
6.26.2.37	spr_tt_group	318
6.26.2.38	spr_ttmr	319

6.26.2.39	spr_upr	319
6.26.2.40	spr_vr	319
6.27	cpu/or1k/spr-dump.h File Reference	320
6.27.1	Function Documentation	320
6.27.1.1	dump_spr	320
6.28	cpu/or1k/sprs.c File Reference	321
6.28.1	Function Documentation	322
6.28.1.1	DECLARE_DEBUG_CHANNEL	322
6.28.1.2	mfspr	322
6.28.1.3	mtspr	322
6.28.1.4	sprs_status	322
6.28.2	Variable Documentation	322
6.28.2.1	audio_cnt	322
6.28.2.2	fo	322
6.29	cpu/or1k/sprs.h File Reference	323
6.29.1	Function Documentation	323
6.29.1.1	dump_spr	323
6.29.1.2	mfspr	324
6.29.1.3	mtspr	324
6.29.1.4	sprs_status	324
6.30	cpu/or32/common-i386.h File Reference	325
6.30.1	Function Documentation	325
6.30.1.1	get_pc	325
6.30.1.2	set_pc	325
6.30.1.3	upd_sim_cycles	325
6.30.2	Variable Documentation	325
6.30.2.1	high32	325
6.30.2.2	low32	325
6.30.2.3	useless_x86	325
6.30.2.4	val3232	325
6.30.2.5	val64	325
6.31	cpu/or32/def-op-t.h File Reference	326
6.31.1	Define Documentation	326
6.31.1.1	DEF_1T_OP	326
6.31.1.2	DEF_2T_OP	326
6.31.1.3	DEF_2T_OP_NEQ	326

---

6.31.1.4	DEF_3T_OP	327
6.31.1.5	DEF_3T_OP_NEQ	327
6.31.1.6	DEF_GPR_OP	327
6.31.1.7	GPR_T	327
6.32	cpu/or32/dyn-rec.c File Reference	328
6.32.1	Define Documentation	335
6.32.1.1	OPS_ENLARGE_BY	335
6.32.1.2	RECED_PAGE_ENLARGE_BY	335
6.32.1.3	T_NONE	335
6.32.1.4	TFLAG_DST	335
6.32.1.5	TFLAG_SAVED	335
6.32.1.6	TFLAG_SOURCED	335
6.32.1.7	TFLAG_SRC	335
6.32.2	Typedef Documentation	335
6.32.2.1	generic_gen_op	335
6.32.2.2	imm_gen_op	335
6.32.3	Function Documentation	335
6.32.3.1	add_to_op_params	335
6.32.3.2	add_to_opq	335
6.32.3.3	DEF_1T_OP	335
6.32.3.4	DEF_1T_OP	335
6.32.3.5	DEF_1T_OP	335
6.32.3.6	DEF_1T_OP	335
6.32.3.7	DEF_1T_OP	335
6.32.3.8	DEF_1T_OP	335
6.32.3.9	DEF_1T_OP	335
6.32.3.10	DEF_1T_OP	335
6.32.3.11	DEF_1T_OP	335
6.32.3.12	DEF_1T_OP	335
6.32.3.13	DEF_1T_OP	335
6.32.3.14	DEF_1T_OP	335
6.32.3.15	DEF_1T_OP	335
6.32.3.16	DEF_1T_OP	335
6.32.3.17	DEF_1T_OP	335
6.32.3.18	DEF_1T_OP	335
6.32.3.19	DEF_1T_OP	335

---

6.32.3.20 DEF_1T_OP . . . . .	335
6.32.3.21 DEF_1T_OP . . . . .	335
6.32.3.22 DEF_1T_OP . . . . .	335
6.32.3.23 DEF_1T_OP . . . . .	335
6.32.3.24 DEF_1T_OP . . . . .	335
6.32.3.25 DEF_1T_OP . . . . .	335
6.32.3.26 DEF_1T_OP . . . . .	335
6.32.3.27 DEF_1T_OP . . . . .	335
6.32.3.28 DEF_1T_OP . . . . .	335
6.32.3.29 DEF_1T_OP . . . . .	335
6.32.3.30 DEF_1T_OP . . . . .	335
6.32.3.31 DEF_1T_OP . . . . .	335
6.32.3.32 DEF_1T_OP . . . . .	335
6.32.3.33 DEF_1T_OP . . . . .	335
6.32.3.34 DEF_1T_OP . . . . .	335
6.32.3.35 DEF_1T_OP . . . . .	335
6.32.3.36 DEF_1T_OP . . . . .	335
6.32.3.37 DEF_1T_OP . . . . .	335
6.32.3.38 DEF_1T_OP . . . . .	335
6.32.3.39 DEF_1T_OP . . . . .	335
6.32.3.40 DEF_1T_OP . . . . .	335
6.32.3.41 DEF_1T_OP . . . . .	335
6.32.3.42 DEF_1T_OP . . . . .	335
6.32.3.43 DEF_1T_OP . . . . .	335
6.32.3.44 DEF_1T_OP . . . . .	335
6.32.3.45 DEF_2T_OP . . . . .	335
6.32.3.46 DEF_2T_OP . . . . .	335
6.32.3.47 DEF_2T_OP . . . . .	335
6.32.3.48 DEF_2T_OP . . . . .	335
6.32.3.49 DEF_2T_OP . . . . .	335
6.32.3.50 DEF_2T_OP . . . . .	335
6.32.3.51 DEF_2T_OP . . . . .	335
6.32.3.52 DEF_2T_OP . . . . .	335
6.32.3.53 DEF_2T_OP . . . . .	335
6.32.3.54 DEF_2T_OP . . . . .	335
6.32.3.55 DEF_2T_OP . . . . .	335



---

6.32.3.56 DEF_2T_OP . . . . .	335
6.32.3.57 DEF_2T_OP . . . . .	335
6.32.3.58 DEF_2T_OP . . . . .	335
6.32.3.59 DEF_2T_OP . . . . .	335
6.32.3.60 DEF_2T_OP . . . . .	335
6.32.3.61 DEF_2T_OP . . . . .	335
6.32.3.62 DEF_2T_OP . . . . .	335
6.32.3.63 DEF_2T_OP . . . . .	335
6.32.3.64 DEF_2T_OP . . . . .	335
6.32.3.65 DEF_2T_OP . . . . .	335
6.32.3.66 DEF_2T_OP . . . . .	335
6.32.3.67 DEF_2T_OP . . . . .	335
6.32.3.68 DEF_2T_OP . . . . .	335
6.32.3.69 DEF_2T_OP . . . . .	335
6.32.3.70 DEF_2T_OP . . . . .	335
6.32.3.71 DEF_2T_OP . . . . .	335
6.32.3.72 DEF_2T_OP . . . . .	335
6.32.3.73 DEF_2T_OP . . . . .	335
6.32.3.74 DEF_2T_OP . . . . .	335
6.32.3.75 DEF_2T_OP . . . . .	335
6.32.3.76 DEF_2T_OP . . . . .	335
6.32.3.77 DEF_2T_OP . . . . .	335
6.32.3.78 DEF_2T_OP . . . . .	335
6.32.3.79 DEF_2T_OP . . . . .	335
6.32.3.80 DEF_2T_OP . . . . .	335
6.32.3.81 DEF_2T_OP . . . . .	335
6.32.3.82 DEF_2T_OP_NEQ . . . . .	335
6.32.3.83 DEF_3T_OP . . . . .	335
6.32.3.84 DEF_3T_OP . . . . .	335
6.32.3.85 DEF_3T_OP . . . . .	335
6.32.3.86 DEF_3T_OP . . . . .	335
6.32.3.87 DEF_3T_OP . . . . .	335
6.32.3.88 DEF_3T_OP . . . . .	335
6.32.3.89 DEF_3T_OP . . . . .	335
6.32.3.90 DEF_3T_OP . . . . .	335
6.32.3.91 DEF_3T_OP . . . . .	335

---

6.32.3.92	DEF_3T_OP	335
6.32.3.93	DEF_3T_OP_NEQ	335
6.32.3.94	DEF_3T_OP_NEQ	335
6.32.3.95	DEF_3T_OP_NEQ	335
6.32.3.96	DEF_3T_OP_NEQ	335
6.32.3.97	DEF_GPR_OP	335
6.32.3.98	DEF_GPR_OP	335
6.32.3.99	dirtyfy_page	335
6.32.3.100	dyn_checkwrite	336
6.32.3.101	dyn_main	336
6.32.3.102	dyn_ret_stack_prot	337
6.32.3.103	dyn_sigsegv_debug	337
6.32.3.104	enough_host_page	337
6.32.3.105	eval_insn_ops	337
6.32.3.106	find_jump_loc	337
6.32.3.107	find_t	338
6.32.3.108	gen_j_imm	338
6.32.3.109	gen_j_reg	338
6.32.3.110	gen_l_add	338
6.32.3.111	gen_l_addc	338
6.32.3.112	gen_l_and	338
6.32.3.113	gen_l_bf	338
6.32.3.114	gen_l_bnf	339
6.32.3.115	gen_l_cmov	340
6.32.3.116	gen_l_cust1	340
6.32.3.117	gen_l_cust2	340
6.32.3.118	gen_l_cust3	340
6.32.3.119	gen_l_cust4	340
6.32.3.120	gen_l_cust5	340
6.32.3.121	gen_l_cust6	340
6.32.3.122	gen_l_cust7	340
6.32.3.123	gen_l_cust8	340
6.32.3.124	gen_l_div	340
6.32.3.125	gen_l_divu	340
6.32.3.126	gen_l_extbs	340
6.32.3.127	gen_l_extbz	340

6.32.3.128	gen_l_exths	340
6.32.3.129	gen_l_exthz	340
6.32.3.130	gen_l_extws	340
6.32.3.131	gen_l_extwz	340
6.32.3.132	gen_l_ffl	340
6.32.3.133	gen_l_invalid	340
6.32.3.134	gen_l_j	340
6.32.3.135	gen_l_jal	341
6.32.3.136	gen_l_jalr	341
6.32.3.137	gen_l_jr	341
6.32.3.138	gen_l_lbs	341
6.32.3.139	gen_l_lbz	342
6.32.3.140	gen_l_lhs	342
6.32.3.141	gen_l_lhz	342
6.32.3.142	gen_l_lws	342
6.32.3.143	gen_l_lwz	342
6.32.3.144	gen_l_mac	343
6.32.3.145	gen_l_macrc	343
6.32.3.146	gen_l_mfspr	343
6.32.3.147	gen_l_movhi	343
6.32.3.148	gen_l_msb	343
6.32.3.149	gen_l_mtspr	343
6.32.3.150	gen_l_mul	343
6.32.3.151	gen_l_mulu	343
6.32.3.152	gen_l_nop	343
6.32.3.153	gen_l_or	343
6.32.3.154	gen_l_rfe	343
6.32.3.155	gen_l_sb	343
6.32.3.156	gen_l_sfeq	344
6.32.3.157	gen_l_sfges	344
6.32.3.158	gen_l_sfgeu	344
6.32.3.159	gen_l_sfgts	344
6.32.3.160	gen_l_sfgtu	344
6.32.3.161	gen_l_sfles	344
6.32.3.162	gen_l_sfleu	344
6.32.3.163	gen_l_sftts	344

---

6.32.3.164	gen_l_sftu	344
6.32.3.165	gen_l_sfne	344
6.32.3.166	gen_l_sh	344
6.32.3.167	gen_l_sll	344
6.32.3.168	gen_l_sra	344
6.32.3.169	gen_l_srl	344
6.32.3.170	gen_l_sub	344
6.32.3.171	gen_l_sw	344
6.32.3.172	gen_l_sys	345
6.32.3.173	gen_l_trap	345
6.32.3.174	gen_l_xor	345
6.32.3.175	gen_lf_add_s	345
6.32.3.176	gen_lf_div_s	345
6.32.3.177	gen_lf_ftoi_s	345
6.32.3.178	gen_lf_itof_s	345
6.32.3.179	gen_lf_madd_s	345
6.32.3.180	gen_lf_mul_s	346
6.32.3.181	gen_lf_rem_s	346
6.32.3.182	gen_lf_sfreq_s	346
6.32.3.183	gen_lf_sfge_s	346
6.32.3.184	gen_lf_sfgt_s	346
6.32.3.185	gen_lf_sfle_s	346
6.32.3.186	gen_lf_sflt_s	347
6.32.3.187	gen_lf_sfne_s	347
6.32.3.188	gen_lf_sub_s	347
6.32.3.189	gen_op_mark_loc	347
6.32.3.190	immu_retranslate	348
6.32.3.191	init_dyn_recomp	348
6.32.3.192	new_dp	348
6.32.3.193	recheck_immu	348
6.32.3.194	recompile_delay_insn	349
6.32.3.195	recompile_insn	349
6.32.3.196	recompile_page	349
6.32.3.197	run_sched_out_of_line	350
6.32.3.198	ship_gprs_out_t	350
6.32.3.199	ship_t_out	350

6.32.4	Variable Documentation	350
6.32.4.1	__op_param1	350
6.32.4.2	__op_param2	350
6.32.4.3	__op_param3	350
6.32.4.4	do_stats	350
6.32.4.5	set_pc_delay_gpr	351
6.32.4.6	sigsegv_addr	351
6.32.4.7	sigsegv_state	351
6.33	cpu/or32/dyn-rec.h File Reference	352
6.33.1	Define Documentation	353
6.33.1.1	glue	353
6.33.1.2	IMMU_GOT_DISABLED	353
6.33.1.3	IMMU_GOT_ENABLED	353
6.33.1.4	xglue	353
6.33.2	Typedef Documentation	353
6.33.2.1	gen_code_ent	353
6.33.3	Function Documentation	353
6.33.3.1	add_to_op_params	353
6.33.3.2	add_to_opq	353
6.33.3.3	dyn_checkwrite	353
6.33.3.4	dyn_main	354
6.33.3.5	enough_host_page	354
6.33.3.6	enter_dyn_code	354
6.33.3.7	init_dyn_recomp	354
6.33.3.8	new_dp	355
6.33.3.9	recheck_immu	355
6.33.3.10	recompile_page	355
6.33.3.11	run_sched_out_of_line	356
6.33.4	Variable Documentation	356
6.33.4.1	rec_stack_base	356
6.34	cpu/or32/dyn32-defs.h File Reference	357
6.34.1	Function Documentation	357
6.34.1.1	l_none	357
6.34.1.2	PARAMS	357
6.35	cpu/or32/dyngen-elf.c File Reference	358
6.35.1	Function Documentation	358

6.35.1.1	elf_close_obj . . . . .	358
6.35.1.2	elf_find_func . . . . .	358
6.35.1.3	elf_get_func_len . . . . .	358
6.35.1.4	elf_get_func_name . . . . .	359
6.35.1.5	elf_get_func_reloc . . . . .	359
6.35.1.6	elf_get_func_start . . . . .	359
6.35.1.7	elf_get_sym_name . . . . .	359
6.35.1.8	elf_open_obj . . . . .	359
6.35.2	Variable Documentation . . . . .	359
6.35.2.1	bffs . . . . .	359
6.36	cpu/or32/dyngen-i386.c File Reference . . . . .	360
6.36.1	Define Documentation . . . . .	360
6.36.1.1	RET_OPCODE . . . . .	360
6.36.2	Function Documentation . . . . .	360
6.36.2.1	i386_gen_func_reloc . . . . .	360
6.36.2.2	i386_gen_reloc . . . . .	360
6.36.2.3	i386_get_real_func_len . . . . .	360
6.36.3	Variable Documentation . . . . .	360
6.36.3.1	archfs . . . . .	360
6.37	cpu/or32/dyngen.c File Reference . . . . .	362
6.37.1	Define Documentation . . . . .	363
6.37.1.1	MAX_PARAMS . . . . .	363
6.37.1.2	OP_FUNC_PARAM_PREFIX . . . . .	363
6.37.1.3	OP_FUNC_PREFIX . . . . .	363
6.37.2	Function Documentation . . . . .	363
6.37.2.1	gen_func_proto . . . . .	363
6.37.2.2	main . . . . .	363
6.37.3	Variable Documentation . . . . .	363
6.37.3.1	c_file_head . . . . .	363
6.37.3.2	c_rel_file_head . . . . .	363
6.37.3.3	c_rel_file_tail . . . . .	363
6.37.3.4	c_sw_file_head . . . . .	364
6.37.3.5	c_sw_file_tail . . . . .	364
6.37.3.6	gen_code_proto . . . . .	364
6.38	cpu/or32/dyngen.h File Reference . . . . .	365
6.38.1	Variable Documentation . . . . .	365

6.38.1.1	archfs	365
6.38.1.2	bffs	365
6.39	cpu/or32/execute.c File Reference	366
6.39.1	Function Documentation	367
6.39.1.1	analysis	367
6.39.1.2	check_depend	368
6.39.1.3	cpu_clock	368
6.39.1.4	cpu_reset	369
6.39.1.5	decode_execute	369
6.39.1.6	decode_execute_wrapper	369
6.39.1.7	dump_exe_log	370
6.39.1.8	dumpreg	370
6.39.1.9	eval_operand_val	371
6.39.1.10	evalsim_reg	371
6.39.1.11	exec_main	372
6.39.1.12	fetch	374
6.39.1.13	l_invalid	374
6.39.1.14	sbuf_load	375
6.39.1.15	sbuf_store	375
6.39.1.16	setsim_reg	375
6.39.1.17	update_pc	375
6.39.2	Variable Documentation	375
6.39.2.1	breakpoint	375
6.39.2.2	cpu_state	375
6.39.2.3	do_stats	375
6.39.2.4	hist_exec_tail	376
6.39.2.5	issued_per_cycle	376
6.39.2.6	multitissue	376
6.39.2.7	next_delay_insn	376
6.39.2.8	pcnext	376
6.39.2.9	sbuf_buf	376
6.39.2.10	sbuf_count	376
6.39.2.11	sbuf_head	376
6.39.2.12	sbuf_prev_cycles	376
6.39.2.13	sbuf_tail	376
6.39.2.14	sbuf_total_cyc	376

6.39.2.15	sbuf_wait_cyc	376
6.40	cpu/or32/generate.c File Reference	377
6.40.1	Function Documentation	377
6.40.1.1	gen_eval_operands	377
6.40.1.2	generate_body	378
6.40.1.3	generate_footer	378
6.40.1.4	generate_header	378
6.40.1.5	main	378
6.40.1.6	output_call	379
6.40.1.7	output_function	379
6.40.1.8	shift_fprintf	379
6.40.2	Variable Documentation	379
6.40.2.1	in_file	379
6.40.2.2	out_file	379
6.40.2.3	out_lines	379
6.40.2.4	write_to_reg	379
6.41	cpu/or32/i386-regs.h File Reference	380
6.41.1	Define Documentation	380
6.41.1.1	CPU_STATE_REG	380
6.41.1.2	NUM_T_REGS	380
6.41.1.3	T0_REG	380
6.41.1.4	T1_REG	380
6.41.1.5	T2_REG	380
6.42	cpu/or32/insnset.c File Reference	381
6.42.1	Function Documentation	384
6.42.1.1	INSTRUCTION	384
6.42.1.2	INSTRUCTION	384
6.42.1.3	INSTRUCTION	384
6.42.1.4	INSTRUCTION	384
6.42.1.5	INSTRUCTION	384
6.42.1.6	INSTRUCTION	384
6.42.1.7	INSTRUCTION	384
6.42.1.8	INSTRUCTION	384
6.42.1.9	INSTRUCTION	384
6.42.1.10	INSTRUCTION	384
6.42.1.11	INSTRUCTION	384



---

6.42.1.12 INSTRUCTION . . . . .	384
6.42.1.13 INSTRUCTION . . . . .	384
6.42.1.14 INSTRUCTION . . . . .	384
6.42.1.15 INSTRUCTION . . . . .	384
6.42.1.16 INSTRUCTION . . . . .	384
6.42.1.17 INSTRUCTION . . . . .	384
6.42.1.18 INSTRUCTION . . . . .	384
6.42.1.19 INSTRUCTION . . . . .	384
6.42.1.20 INSTRUCTION . . . . .	384
6.42.1.21 INSTRUCTION . . . . .	384
6.42.1.22 INSTRUCTION . . . . .	384
6.42.1.23 INSTRUCTION . . . . .	384
6.42.1.24 INSTRUCTION . . . . .	384
6.42.1.25 INSTRUCTION . . . . .	385
6.42.1.26 INSTRUCTION . . . . .	385
6.42.1.27 INSTRUCTION . . . . .	385
6.42.1.28 INSTRUCTION . . . . .	386
6.42.1.29 INSTRUCTION . . . . .	386
6.42.1.30 INSTRUCTION . . . . .	386
6.42.1.31 INSTRUCTION . . . . .	386
6.42.1.32 INSTRUCTION . . . . .	386
6.42.1.33 INSTRUCTION . . . . .	386
6.42.1.34 INSTRUCTION . . . . .	386
6.42.1.35 INSTRUCTION . . . . .	386
6.42.1.36 INSTRUCTION . . . . .	386
6.42.1.37 INSTRUCTION . . . . .	386
6.42.1.38 INSTRUCTION . . . . .	386
6.42.1.39 INSTRUCTION . . . . .	386
6.42.1.40 INSTRUCTION . . . . .	386
6.42.1.41 INSTRUCTION . . . . .	386
6.42.1.42 INSTRUCTION . . . . .	386
6.42.1.43 INSTRUCTION . . . . .	386
6.42.1.44 INSTRUCTION . . . . .	386
6.42.1.45 INSTRUCTION . . . . .	387
6.42.1.46 INSTRUCTION . . . . .	387
6.42.1.47 INSTRUCTION . . . . .	387

---

6.42.1.48 INSTRUCTION . . . . .	387
6.42.1.49 INSTRUCTION . . . . .	388
6.42.1.50 INSTRUCTION . . . . .	388
6.42.1.51 INSTRUCTION . . . . .	388
6.42.1.52 INSTRUCTION . . . . .	388
6.42.1.53 INSTRUCTION . . . . .	388
6.42.1.54 INSTRUCTION . . . . .	388
6.42.1.55 INSTRUCTION . . . . .	388
6.42.1.56 INSTRUCTION . . . . .	389
6.42.1.57 INSTRUCTION . . . . .	389
6.42.1.58 INSTRUCTION . . . . .	389
6.42.1.59 INSTRUCTION . . . . .	389
6.42.1.60 INSTRUCTION . . . . .	389
6.42.1.61 INSTRUCTION . . . . .	389
6.42.1.62 INSTRUCTION . . . . .	389
6.42.1.63 INSTRUCTION . . . . .	389
6.42.1.64 INSTRUCTION . . . . .	390
6.42.1.65 INSTRUCTION . . . . .	390
6.42.1.66 INSTRUCTION . . . . .	390
6.42.1.67 INSTRUCTION . . . . .	391
6.42.1.68 INSTRUCTION . . . . .	391
6.42.1.69 INSTRUCTION . . . . .	392
6.42.1.70 INSTRUCTION . . . . .	392
6.42.1.71 INSTRUCTION . . . . .	392
6.42.1.72 INSTRUCTION . . . . .	392
6.43 cpu/or32/op-1t-op.h File Reference . . . . .	393
6.43.1 Function Documentation . . . . .	393
6.43.1.1 glue . . . . .	393
6.43.1.2 glue . . . . .	393
6.43.1.3 glue . . . . .	393
6.43.1.4 glue . . . . .	393
6.43.1.5 glue . . . . .	393
6.43.1.6 glue . . . . .	393
6.43.1.7 glue . . . . .	393
6.44 cpu/or32/op-1t.h File Reference . . . . .	394
6.44.1 Define Documentation . . . . .	394

6.44.1.1	OP_1T	394
6.44.1.2	T	394
6.45	cpu/or32/op-2t-op.h File Reference	395
6.45.1	Function Documentation	395
6.45.1.1	glue	395
6.45.1.2	glue	395
6.45.1.3	glue	395
6.46	cpu/or32/op-2t.h File Reference	396
6.46.1	Define Documentation	396
6.46.1.1	OP_2T	396
6.46.1.2	T	396
6.47	cpu/or32/op-3t-op.h File Reference	397
6.47.1	Function Documentation	397
6.47.1.1	glue	397
6.48	cpu/or32/op-3t.h File Reference	398
6.48.1	Define Documentation	398
6.48.1.1	OP_3T	398
6.48.1.2	T	398
6.49	cpu/or32/op-arith-op.h File Reference	399
6.50	cpu/or32/op-comp-op.h File Reference	400
6.51	cpu/or32/op-extend-op.h File Reference	401
6.51.1	Function Documentation	401
6.51.1.1	glue	401
6.52	cpu/or32/op-ff1-op.h File Reference	402
6.52.1	Function Documentation	402
6.52.1.1	glue	402
6.53	cpu/or32/op-i386.h File Reference	403
6.53.1	Define Documentation	403
6.53.1.1	FORCE_RET	403
6.53.1.2	OP_JUMP	403
6.53.1.3	SPEEDY_CALL	403
6.53.2	Function Documentation	403
6.53.2.1	asm	403
6.54	cpu/or32/op-lwhb-op.h File Reference	404
6.55	cpu/or32/op-mac-op.h File Reference	405
6.55.1	Function Documentation	405

---

6.55.1.1	glue	405
6.56	cpu/or32/op-mftspr-op.h File Reference	406
6.56.1	Function Documentation	406
6.56.1.1	op_mtspr_imm_clear	406
6.57	cpu/or32/op-support.c File Reference	407
6.57.1	Function Documentation	408
6.57.1.1	do_jump	408
6.57.1.2	op_support_analysis	408
6.57.1.3	op_support_nop_exit	408
6.57.1.4	op_support_nop_printf	408
6.57.1.5	op_support_nop_report	408
6.57.1.6	op_support_nop_report_imm	408
6.57.1.7	op_support_nop_reset	408
6.58	cpu/or32/op-support.h File Reference	409
6.58.1	Function Documentation	409
6.58.1.1	do_jump	409
6.58.1.2	op_support_analysis	409
6.58.1.3	op_support_nop_exit	410
6.58.1.4	op_support_nop_printf	410
6.58.1.5	op_support_nop_report	410
6.58.1.6	op_support_nop_report_imm	410
6.58.1.7	op_support_nop_reset	410
6.58.1.8	upd_reg_from_t	410
6.59	cpu/or32/op-swhb-op.h File Reference	411
6.59.1	Function Documentation	411
6.59.1.1	glue	411
6.60	cpu/or32/op-t-reg-mov-op.h File Reference	412
6.60.1	Function Documentation	415
6.60.1.1	glue	415
6.60.1.2	glue	415
6.60.1.3	glue	415
6.60.1.4	glue	415
6.60.1.5	glue	415
6.60.1.6	glue	415
6.60.1.7	glue	415
6.60.1.8	glue	415

---

6.60.1.9 glue	415
6.60.1.10 glue	415
6.60.1.11 glue	415
6.60.1.12 glue	415
6.60.1.13 glue	415
6.60.1.14 glue	415
6.60.1.15 glue	415
6.60.1.16 glue	415
6.60.1.17 glue	415
6.60.1.18 glue	415
6.60.1.19 glue	415
6.60.1.20 glue	415
6.60.1.21 glue	415
6.60.1.22 glue	415
6.60.1.23 glue	415
6.60.1.24 glue	415
6.60.1.25 glue	415
6.60.1.26 glue	415
6.60.1.27 glue	415
6.60.1.28 glue	415
6.60.1.29 glue	415
6.60.1.30 glue	415
6.60.1.31 glue	415
6.60.1.32 glue	415
6.60.1.33 glue	415
6.60.1.34 glue	415
6.60.1.35 glue	415
6.60.1.36 glue	415
6.60.1.37 glue	415
6.60.1.38 glue	415
6.60.1.39 glue	415
6.60.1.40 glue	415
6.60.1.41 glue	415
6.60.1.42 glue	415
6.60.1.43 glue	415
6.60.1.44 glue	415

---

6.60.1.45 glue	415
6.60.1.46 glue	415
6.60.1.47 glue	415
6.60.1.48 glue	415
6.60.1.49 glue	415
6.60.1.50 glue	415
6.60.1.51 glue	415
6.60.1.52 glue	415
6.60.1.53 glue	415
6.60.1.54 glue	415
6.60.1.55 glue	415
6.60.1.56 glue	415
6.60.1.57 glue	415
6.60.1.58 glue	415
6.60.1.59 glue	415
6.60.1.60 glue	415
6.60.1.61 glue	415
6.60.1.62 glue	415
6.61 cpu/or32/op.c File Reference	416
6.61.1 Define Documentation	423
6.61.1.1 __or_dynop	423
6.61.1.2 COMP	423
6.61.1.3 COMP	423
6.61.1.4 COMP	423
6.61.1.5 COMP	423
6.61.1.6 COMP	423
6.61.1.7 COMP	423
6.61.1.8 COMP	423
6.61.1.9 COMP	423
6.61.1.10 COMP	423
6.61.1.11 COMP	423
6.61.1.12 COMP_CAST	423
6.61.1.13 COMP_CAST	423
6.61.1.14 COMP_CAST	423
6.61.1.15 COMP_CAST	423
6.61.1.16 COMP_CAST	423

---

6.61.1.17 COMP_CAST . . . . .	423
6.61.1.18 COMP_CAST . . . . .	423
6.61.1.19 COMP_CAST . . . . .	423
6.61.1.20 COMP_CAST . . . . .	423
6.61.1.21 COMP_CAST . . . . .	423
6.61.1.22 COMP_NAME . . . . .	423
6.61.1.23 COMP_NAME . . . . .	423
6.61.1.24 COMP_NAME . . . . .	423
6.61.1.25 COMP_NAME . . . . .	423
6.61.1.26 COMP_NAME . . . . .	423
6.61.1.27 COMP_NAME . . . . .	423
6.61.1.28 COMP_NAME . . . . .	423
6.61.1.29 COMP_NAME . . . . .	423
6.61.1.30 COMP_NAME . . . . .	423
6.61.1.31 COMP_NAME . . . . .	423
6.61.1.32 EXT_CAST . . . . .	423
6.61.1.33 EXT_CAST . . . . .	423
6.61.1.34 EXT_CAST . . . . .	423
6.61.1.35 EXT_CAST . . . . .	423
6.61.1.36 EXT_NAME . . . . .	423
6.61.1.37 EXT_NAME . . . . .	423
6.61.1.38 EXT_NAME . . . . .	423
6.61.1.39 EXT_NAME . . . . .	423
6.61.1.40 EXT_TYPE . . . . .	423
6.61.1.41 EXT_TYPE . . . . .	423
6.61.1.42 EXT_TYPE . . . . .	423
6.61.1.43 EXT_TYPE . . . . .	423
6.61.1.44 LS_OP_CAST . . . . .	423
6.61.1.45 LS_OP_CAST . . . . .	423
6.61.1.46 LS_OP_CAST . . . . .	423
6.61.1.47 LS_OP_CAST . . . . .	423
6.61.1.48 LS_OP_CAST . . . . .	423
6.61.1.49 LS_OP_CAST . . . . .	423
6.61.1.50 LS_OP_FUNC . . . . .	423
6.61.1.51 LS_OP_FUNC . . . . .	423
6.61.1.52 LS_OP_FUNC . . . . .	423

---

6.61.1.53 LS_OP_FUNC . . . . .	423
6.61.1.54 LS_OP_FUNC . . . . .	423
6.61.1.55 LS_OP_FUNC . . . . .	423
6.61.1.56 LS_OP_NAME . . . . .	423
6.61.1.57 LS_OP_NAME . . . . .	423
6.61.1.58 LS_OP_NAME . . . . .	423
6.61.1.59 LS_OP_NAME . . . . .	423
6.61.1.60 LS_OP_NAME . . . . .	423
6.61.1.61 LS_OP_NAME . . . . .	423
6.61.1.62 OP . . . . .	423
6.61.1.63 OP . . . . .	423
6.61.1.64 OP . . . . .	423
6.61.1.65 OP . . . . .	423
6.61.1.66 OP . . . . .	423
6.61.1.67 OP . . . . .	423
6.61.1.68 OP . . . . .	423
6.61.1.69 OP . . . . .	423
6.61.1.70 OP . . . . .	423
6.61.1.71 OP . . . . .	423
6.61.1.72 OP . . . . .	423
6.61.1.73 OP . . . . .	423
6.61.1.74 OP . . . . .	423
6.61.1.75 OP . . . . .	423
6.61.1.76 OP . . . . .	423
6.61.1.77 OP_CAST . . . . .	423
6.61.1.78 OP_CAST . . . . .	423
6.61.1.79 OP_CAST . . . . .	423
6.61.1.80 OP_CAST . . . . .	423
6.61.1.81 OP_CAST . . . . .	423
6.61.1.82 OP_CAST . . . . .	423
6.61.1.83 OP_CAST . . . . .	423
6.61.1.84 OP_CAST . . . . .	423
6.61.1.85 OP_CAST . . . . .	423
6.61.1.86 OP_CAST . . . . .	423
6.61.1.87 OP_CAST . . . . .	423
6.61.1.88 OP_CAST . . . . .	423



6.61.1.89 OP_CAST . . . . .	423
6.61.1.90 OP_EXTRA . . . . .	423
6.61.1.91 OP_EXTRA . . . . .	423
6.61.1.92 OP_EXTRA . . . . .	423
6.61.1.93 OP_FILE . . . . .	423
6.61.1.94 OP_FILE . . . . .	423
6.61.1.95 OP_FILE . . . . .	423
6.61.1.96 OP_FILE . . . . .	423
6.61.1.97 OP_FILE . . . . .	423
6.61.1.98 OP_FILE . . . . .	423
6.61.1.99 OP_FILE . . . . .	423
6.61.1.100OP_FILE . . . . .	423
6.61.1.101OP_FILE . . . . .	423
6.61.1.102OP_FILE . . . . .	423
6.61.1.103OP_FILE . . . . .	423
6.61.1.104OP_NAME . . . . .	423
6.61.1.105OP_NAME . . . . .	423
6.61.1.106OP_NAME . . . . .	423
6.61.1.107OP_NAME . . . . .	423
6.61.1.108OP_NAME . . . . .	423
6.61.1.109OP_NAME . . . . .	423
6.61.1.110OP_NAME . . . . .	423
6.61.1.111OP_NAME . . . . .	423
6.61.1.112OP_NAME . . . . .	423
6.61.1.113OP_NAME . . . . .	423
6.61.1.114OP_NAME . . . . .	423
6.61.1.115OP_NAME . . . . .	423
6.61.1.116OP_NAME . . . . .	423
6.61.1.117OP_NAME . . . . .	423
6.61.1.118OP_NAME . . . . .	423
6.61.1.119OP_PARAM1 . . . . .	423
6.61.1.120OP_PARAM2 . . . . .	423
6.61.1.121OP_PARAM3 . . . . .	423
6.61.1.122S_FUNC . . . . .	423
6.61.1.123S_FUNC . . . . .	423
6.61.1.124S_FUNC . . . . .	423

6.61.1.125S_OP_NAME	423
6.61.1.126S_OP_NAME	423
6.61.1.127S_OP_NAME	423
6.61.2 Function Documentation	423
6.61.2.1 asm	423
6.61.2.2 asm	423
6.61.2.3 asm	423
6.61.2.4 asm	423
6.61.2.5 do_sched_wrap	423
6.61.2.6 do_sched_wrap_delay	424
6.61.2.7 enter_dyn_code	424
6.61.2.8 op_add_pc	424
6.61.2.9 op_analysis	424
6.61.2.10 op_check_delay_slot	424
6.61.2.11 op_check_flag	424
6.61.2.12 op_check_flag_delay	425
6.61.2.13 op_check_not_flag	425
6.61.2.14 op_check_not_flag_delay	425
6.61.2.15 op_clear_delay_insn	425
6.61.2.16 op_clear_flag	425
6.61.2.17 op_clear_pc_delay	425
6.61.2.18 op_do_jump_delay	425
6.61.2.19 op_do_sched	425
6.61.2.20 op_do_sched_delay	425
6.61.2.21 op_illegal	427
6.61.2.22 op_illegal_delay	427
6.61.2.23 op_jmp_imm	427
6.61.2.24 op_join_mem_cycles	427
6.61.2.25 op_macc	427
6.61.2.26 op_move_gpr10_pc_delay	427
6.61.2.27 op_move_gpr11_pc_delay	427
6.61.2.28 op_move_gpr12_pc_delay	427
6.61.2.29 op_move_gpr13_pc_delay	427
6.61.2.30 op_move_gpr14_pc_delay	427
6.61.2.31 op_move_gpr15_pc_delay	427
6.61.2.32 op_move_gpr16_pc_delay	427

---

6.61.2.33 op_move_gpr17_pc_delay . . . . .	427
6.61.2.34 op_move_gpr18_pc_delay . . . . .	427
6.61.2.35 op_move_gpr19_pc_delay . . . . .	427
6.61.2.36 op_move_gpr1_pc_delay . . . . .	427
6.61.2.37 op_move_gpr20_pc_delay . . . . .	427
6.61.2.38 op_move_gpr21_pc_delay . . . . .	427
6.61.2.39 op_move_gpr22_pc_delay . . . . .	427
6.61.2.40 op_move_gpr23_pc_delay . . . . .	427
6.61.2.41 op_move_gpr24_pc_delay . . . . .	427
6.61.2.42 op_move_gpr25_pc_delay . . . . .	427
6.61.2.43 op_move_gpr26_pc_delay . . . . .	427
6.61.2.44 op_move_gpr27_pc_delay . . . . .	427
6.61.2.45 op_move_gpr28_pc_delay . . . . .	427
6.61.2.46 op_move_gpr29_pc_delay . . . . .	427
6.61.2.47 op_move_gpr2_pc_delay . . . . .	427
6.61.2.48 op_move_gpr30_pc_delay . . . . .	427
6.61.2.49 op_move_gpr31_pc_delay . . . . .	427
6.61.2.50 op_move_gpr3_pc_delay . . . . .	427
6.61.2.51 op_move_gpr4_pc_delay . . . . .	427
6.61.2.52 op_move_gpr5_pc_delay . . . . .	427
6.61.2.53 op_move_gpr6_pc_delay . . . . .	427
6.61.2.54 op_move_gpr7_pc_delay . . . . .	427
6.61.2.55 op_move_gpr8_pc_delay . . . . .	427
6.61.2.56 op_move_gpr9_pc_delay . . . . .	427
6.61.2.57 op_nop_exit . . . . .	427
6.61.2.58 op_nop_printf . . . . .	428
6.61.2.59 op_nop_report . . . . .	428
6.61.2.60 op_nop_report_imm . . . . .	428
6.61.2.61 op_nop_reset . . . . .	428
6.61.2.62 op_prep_rfe . . . . .	428
6.61.2.63 op_prep_sys . . . . .	428
6.61.2.64 op_prep_sys_delay . . . . .	429
6.61.2.65 op_prep_trap . . . . .	429
6.61.2.66 op_prep_trap_delay . . . . .	429
6.61.2.67 op_set_delay_insn . . . . .	429
6.61.2.68 op_set_flag . . . . .	429

6.61.2.69	op_set_pc_delay_imm	429
6.61.2.70	op_set_pc_delay_pc	429
6.61.2.71	op_set_pc_pc_delay	429
6.61.2.72	op_store_insn_ea	429
6.61.2.73	op_store_link_addr_gpr	429
6.61.2.74	prep_except	429
6.61.2.75	save_t_bound	429
6.61.3	Variable Documentation	429
6.61.3.1	__op_param1	429
6.61.3.2	__op_param2	429
6.61.3.3	__op_param3	429
6.62	cpu/or32/or32.c File Reference	430
6.62.1	Define Documentation	432
6.62.1.1	EF	432
6.62.1.2	EFI	432
6.62.1.3	EFN	432
6.62.1.4	MAX_AUTOMATA_SIZE	432
6.62.1.5	MAX_LEN	432
6.62.1.6	MAX_OP_TABLE_SIZE	432
6.62.1.7	MIN	432
6.62.2	Function Documentation	432
6.62.2.1	build_automata	432
6.62.2.2	cover_insn	432
6.62.2.3	destruct_automata	433
6.62.2.4	disassemble_index	433
6.62.2.5	disassemble_insn	433
6.62.2.6	extend_imm	433
6.62.2.7	insn_decode	434
6.62.2.8	insn_extract	434
6.62.2.9	insn_index	434
6.62.2.10	insn_len	434
6.62.2.11	insn_name	434
6.62.2.12	l_none	434
6.62.2.13	letter_range	434
6.62.2.14	letter_signed	434
6.62.2.15	num_ones	434

---

6.62.2.16	or32_debug	434
6.62.2.17	or32_extract	434
6.62.2.18	or32_print_immediate	434
6.62.2.19	or32_print_register	434
6.62.2.20	parse_params	435
6.62.3	Variable Documentation	435
6.62.3.1	automata	435
6.62.3.2	curpass	435
6.62.3.3	disassembled	435
6.62.3.4	disassembled_str	435
6.62.3.5	num_opcodes	435
6.62.3.6	nuncovered	435
6.62.3.7	op_data	435
6.62.3.8	op_start	435
6.62.3.9	or32_letters	435
6.62.3.10	or32_opcodes	436
6.62.3.11	range_cache	436
6.62.3.12	ti	436
6.63	cpu/or32/rec-i386.h File Reference	437
6.63.1	Function Documentation	437
6.63.1.1	get_sp	437
6.64	cpu/or32/sched-i386.h File Reference	438
6.64.1	Function Documentation	438
6.64.1.1	set_sched_cycle	438
6.65	cpu/or32/simpl32-defs.h File Reference	439
6.65.1	Function Documentation	439
6.65.1.1	PARAMS	439
6.65.1.2	PARAMS	439
6.66	cuc/adv.c File Reference	440
6.66.1	Function Documentation	441
6.66.1.1	calc_max	441
6.66.1.2	detect_max_values	441
6.66.1.3	insert_conditional_facts	441
6.66.1.4	mark_successors	441
6.66.1.5	mask	441
6.66.1.6	max_op	441

---

6.67	cuc/bb.c File Reference	442
6.67.1	Function Documentation	443
6.67.1.1	build_bb	443
6.67.1.2	count_bb_seq	443
6.67.1.3	cpy_bb	443
6.67.1.4	cuc_check	443
6.67.1.5	detect_bb	444
6.67.1.6	dup_func	444
6.67.1.7	expand_bb	444
6.67.1.8	free_func	444
6.67.1.9	generate_bb_seq	444
6.67.1.10	join_bb	445
6.67.1.11	optimize_bb	445
6.67.1.12	preunroll_loop	445
6.67.1.13	print_bb_num	446
6.67.1.14	print_cuc_bb	446
6.67.1.15	recalc_last_used_reg	446
6.67.1.16	reg_dep	446
6.67.1.17	reg_dep_rec	446
6.67.1.18	relocate_bb	446
6.67.1.19	remove_dead_bb	446
6.67.1.20	roll_loop	446
6.67.1.21	simplify_bb	447
6.68	cuc/cuc.c File Reference	448
6.68.1	Function Documentation	451
6.68.1.1	analyse_function	451
6.68.1.2	calc_cycles	452
6.68.1.3	calc_size	452
6.68.1.4	cuc_calling_conv	452
6.68.1.5	cuc_enable_bursts	452
6.68.1.6	cuc_memory_order	452
6.68.1.7	cuc_no_multicycle	453
6.68.1.8	cuc_optimize	453
6.68.1.9	cuc_timings_fn	454
6.68.1.10	extract_function	454
6.68.1.11	format_func_options	454

6.68.1.12	gen_option	456
6.68.1.13	generate_function	456
6.68.1.14	main_cuc	458
6.68.1.15	options_cmd	459
6.68.1.16	preunroll_bb	461
6.68.1.17	print_option	462
6.68.1.18	reg_cuc_sec	462
6.68.1.19	set_func_deps	462
6.68.1.20	tim_comp	462
6.68.2	Variable Documentation	462
6.68.2.1	caller_saved	462
6.68.2.2	cuc_debug	463
6.68.2.3	flog	463
6.68.2.4	func	463
6.68.2.5	func_v	463
6.68.2.6	option_char	463
6.69	cuc/cuc.h File Reference	464
6.69.1	Define Documentation	469
6.69.1.1	BB_DEAD	469
6.69.1.2	BB_INLOOP	469
6.69.1.3	BB_OPTIONAL	469
6.69.1.4	BBID_END	469
6.69.1.5	BBID_START	469
6.69.1.6	CUC_MAX_STACK	469
6.69.1.7	CUC_WIDTH_ITERATIONS	469
6.69.1.8	cucdebug	469
6.69.1.9	FLAG_REG	469
6.69.1.10	INSN	469
6.69.1.11	IT_BBEND	469
6.69.1.12	IT_BBSTART	469
6.69.1.13	IT_BRANCH	469
6.69.1.14	IT_COND	469
6.69.1.15	IT_CUT	469
6.69.1.16	IT_FLAG1	469
6.69.1.17	IT_FLAG2	469
6.69.1.18	IT_INDELAY	469

---

6.69.1.19 IT_LATCHED . . . . .	469
6.69.1.20 IT_MEMADD . . . . .	469
6.69.1.21 IT_MEMORY . . . . .	469
6.69.1.22 IT_OUTPUT . . . . .	469
6.69.1.23 IT_SIGNED . . . . .	469
6.69.1.24 IT_UNUSED . . . . .	469
6.69.1.25 IT_VOLATILE . . . . .	469
6.69.1.26 log . . . . .	469
6.69.1.27 LRBB_REG . . . . .	469
6.69.1.28 MAX . . . . .	469
6.69.1.29 MAX_BB . . . . .	469
6.69.1.30 MAX_INSNS . . . . .	469
6.69.1.31 MAX_PREROLL . . . . .	469
6.69.1.32 MAX_REGS . . . . .	469
6.69.1.33 MAX_UNROLL . . . . .	469
6.69.1.34 MIN . . . . .	469
6.69.1.35 MO_EXACT . . . . .	469
6.69.1.36 MO_NONE . . . . .	469
6.69.1.37 MO_STRONG . . . . .	469
6.69.1.38 MO_WEAK . . . . .	469
6.69.1.39 MT_BURST . . . . .	469
6.69.1.40 MT_BURSTE . . . . .	469
6.69.1.41 MT_CALL . . . . .	469
6.69.1.42 MT_LOAD . . . . .	469
6.69.1.43 MT_SIGNED . . . . .	469
6.69.1.44 MT_STORE . . . . .	469
6.69.1.45 MT_WIDTH . . . . .	469
6.69.1.46 OPT_BB . . . . .	469
6.69.1.47 OPT_CONST . . . . .	469
6.69.1.48 OPT_DEST . . . . .	469
6.69.1.49 OPT_JUMP . . . . .	469
6.69.1.50 OPT_LRBB . . . . .	469
6.69.1.51 OPT_NONE . . . . .	469
6.69.1.52 OPT_REF . . . . .	469
6.69.1.53 OPT_REGISTER . . . . .	469
6.69.1.54 REF . . . . .	469



---

6.69.1.55	REF_BB	469
6.69.1.56	REF_I	469
6.69.2	Typedef Documentation	469
6.69.2.1	cuc_func	469
6.69.2.2	cuc_shared_list	469
6.69.2.3	dep_list	469
6.69.3	Function Documentation	469
6.69.3.1	add_data_dep	469
6.69.3.2	add_dep	470
6.69.3.3	add_latches	470
6.69.3.4	add_memory_dep	470
6.69.3.5	analyse_timings	470
6.69.3.6	build_bb	470
6.69.3.7	clean_deps	471
6.69.3.8	cse	471
6.69.3.9	csm	471
6.69.3.10	csm_gen	471
6.69.3.11	cuc_check	471
6.69.3.12	cuc_load	472
6.69.3.13	detect_bb	472
6.69.3.14	detect_max_values	472
6.69.3.15	dispose_list	473
6.69.3.16	dup_func	473
6.69.3.17	expand_bb	473
6.69.3.18	free_func	473
6.69.3.19	generate_bb_seq	473
6.69.3.20	insert_conditional_facts	474
6.69.3.21	insert_insns	474
6.69.3.22	main_cuc	476
6.69.3.23	mark_cut	477
6.69.3.24	negate_conditional	477
6.69.3.25	optimize_bb	477
6.69.3.26	optimize_cmovs	477
6.69.3.27	optimize_tree	478
6.69.3.28	preunroll_loop	478
6.69.3.29	print_bb_num	478

6.69.3.30	print_cuc_bb	478
6.69.3.31	print_cuc_insns	479
6.69.3.32	print_insns	479
6.69.3.33	recalc_cnts	479
6.69.3.34	reg_cuc_sec	479
6.69.3.35	reg_dep	480
6.69.3.36	remove_dead	480
6.69.3.37	remove_dead_bb	480
6.69.3.38	remove_nops	480
6.69.3.39	remove_trivial_regs	480
6.69.3.40	schedule_memory	481
6.69.3.41	set_io	481
6.69.4	Variable Documentation	481
6.69.4.1	caller_saved	481
6.69.4.2	cuc_debug	481
6.69.4.3	flog	481
6.69.4.4	insn	481
6.69.4.5	num_insn	481
6.69.4.6	reloc	481
6.70	cuc/insn.c File Reference	482
6.70.1	Function Documentation	483
6.70.1.1	add_data_dep	483
6.70.1.2	add_dep	483
6.70.1.3	add_latches	483
6.70.1.4	apply_edge_condition	484
6.70.1.5	change_insn_type	484
6.70.1.6	cmov_needed	484
6.70.1.7	count_cmovs	484
6.70.1.8	cse	484
6.70.1.9	csm	484
6.70.1.10	csm_gen	484
6.70.1.11	cuc_insn_name	485
6.70.1.12	dispose_list	485
6.70.1.13	insert_insns	485
6.70.1.14	insn_uses	485
6.70.1.15	optimize_cmov_more	485

---

6.70.1.16	optimize_cmovs	485
6.70.1.17	optimize_tree	486
6.70.1.18	print_insns	486
6.70.1.19	print_shared	486
6.70.1.20	remove_dead	486
6.70.1.21	remove_nops	487
6.70.1.22	remove_trivial_regs	487
6.70.1.23	search_csm	487
6.70.1.24	set_io	487
6.70.1.25	unmark_tree	487
6.70.2	Variable Documentation	487
6.70.2.1	iteration	487
6.70.2.2	known	487
6.70.2.3	main_list	487
6.70.2.4	tmp_op	487
6.70.2.5	tmp_opt	487
6.71	cuc/insn.h File Reference	488
6.71.1	Define Documentation	490
6.71.1.1	II_ADD	490
6.71.1.2	II_AND	490
6.71.1.3	II_BF	490
6.71.1.4	II_CALL	490
6.71.1.5	II_CMOV	490
6.71.1.6	II_IS_LOAD	490
6.71.1.7	II_IS_STORE	490
6.71.1.8	II_LAST	490
6.71.1.9	II_LB	490
6.71.1.10	II_LH	490
6.71.1.11	II_LRBB	490
6.71.1.12	II_LW	490
6.71.1.13	II_MASK	490
6.71.1.14	II_MEM	490
6.71.1.15	II_MEM_WIDTH	490
6.71.1.16	II_MUL	492
6.71.1.17	II_NOP	492
6.71.1.18	II_OR	492

6.71.1.19	II_REG	492
6.71.1.20	II_SB	492
6.71.1.21	II_SFEQ	492
6.71.1.22	II_SFGE	492
6.71.1.23	II_SFGT	492
6.71.1.24	II_SFLE	492
6.71.1.25	II_SFLT	492
6.71.1.26	II_SFNE	492
6.71.1.27	II_SH	492
6.71.1.28	II_SIGNED	492
6.71.1.29	II_SLL	492
6.71.1.30	II_SRA	492
6.71.1.31	II_SRL	492
6.71.1.32	II_SUB	492
6.71.1.33	II_SW	492
6.71.1.34	II_XOR	492
6.71.2	Function Documentation	492
6.71.2.1	change_insn_type	492
6.71.2.2	cuc_insn_name	492
6.71.2.3	ii_size	492
6.71.2.4	insn_size	492
6.71.2.5	insn_time	492
6.71.2.6	load_timing_table	492
6.71.2.7	print_shared	492
6.71.3	Variable Documentation	493
6.71.3.1	known	493
6.72	cuc/load.c File Reference	494
6.72.1	Function Documentation	495
6.72.1.1	build_insn	495
6.72.1.2	cuc_load	496
6.72.1.3	detect_locals	496
6.72.1.4	expand_branch	496
6.72.1.5	expand_calls	496
6.72.1.6	expand_memory	497
6.72.1.7	expand_signed	497
6.72.1.8	negate_conditional	497

---

6.72.1.9	print_cuc_insn	497
6.72.1.10	remove_dslots	497
6.72.1.11	xchg_insn	498
6.72.2	Variable Documentation	498
6.72.2.1	conv	498
6.72.2.2	insn	498
6.72.2.3	num_insn	498
6.72.2.4	reloc	498
6.73	cuc/memory.c File Reference	499
6.73.1	Function Documentation	500
6.73.1.1	add_memory_dep	500
6.73.1.2	check_memory_conflict	500
6.73.1.3	clean_deps	500
6.73.1.4	join_transfers	500
6.73.1.5	mem_ordering_cmp	500
6.73.1.6	same_transfers	500
6.73.1.7	schedule_memory	501
6.74	peripheral/memory.c File Reference	502
6.74.1	Function Documentation	503
6.74.1.1	mem_reset	503
6.74.1.2	memory_baseaddr	503
6.74.1.3	memory_ce	503
6.74.1.4	memory_delayr	503
6.74.1.5	memory_delayw	503
6.74.1.6	memory_log	503
6.74.1.7	memory_mc	503
6.74.1.8	memory_name	503
6.74.1.9	memory_pattern	503
6.74.1.10	memory_random_seed	504
6.74.1.11	memory_sec_end	504
6.74.1.12	memory_sec_start	504
6.74.1.13	memory_size	504
6.74.1.14	memory_type	504
6.74.1.15	reg_memory_sec	505
6.74.1.16	simmem_read16	506
6.74.1.17	simmem_read32	506

6.74.1.18	<code>simmem_read8</code>	506
6.74.1.19	<code>simmem_read_zero16</code>	506
6.74.1.20	<code>simmem_read_zero32</code>	506
6.74.1.21	<code>simmem_read_zero8</code>	506
6.74.1.22	<code>simmem_write16</code>	506
6.74.1.23	<code>simmem_write32</code>	506
6.74.1.24	<code>simmem_write8</code>	506
6.74.1.25	<code>simmem_write_null16</code>	506
6.74.1.26	<code>simmem_write_null32</code>	506
6.74.1.27	<code>simmem_write_null8</code>	506
6.75	<code>cuc/timings.c</code> File Reference	507
6.75.1	Function Documentation	508
6.75.1.1	<code>analyse_timings</code>	508
6.75.1.2	<code>bb_size</code>	508
6.75.1.3	<code>cut_tree</code>	508
6.75.1.4	<code>ii_size</code>	509
6.75.1.5	<code>insn_size</code>	509
6.75.1.6	<code>insn_time</code>	509
6.75.1.7	<code>load_timing_table</code>	509
6.75.1.8	<code>mark_cut</code>	509
6.75.1.9	<code>max_delay</code>	509
6.75.1.10	<code>memory_delay</code>	509
6.75.1.11	<code>new_bb_cycles</code>	509
6.75.1.12	<code>recalc_cnts</code>	509
6.75.2	Variable Documentation	509
6.75.2.1	<code>max_bb_delay</code>	509
6.75.2.2	<code>timing_table</code>	509
6.76	<code>cuc/verilog.c</code> File Reference	510
6.76.1	Define Documentation	511
6.76.1.1	<code>GEN</code>	511
6.76.2	Function Documentation	511
6.76.2.1	<code>branch_index</code>	511
6.76.2.2	<code>find_lsc_index</code>	511
6.76.2.3	<code>func_index</code>	511
6.76.2.4	<code>generate_main</code>	511
6.76.2.5	<code>output_verilog</code>	511

6.76.2.6	print_deps	512
6.76.2.7	print_insn_v	512
6.76.2.8	print_op_v	512
6.76.2.9	print_turn_off_dep	512
6.77	cuc/verilog.h File Reference	513
6.77.1	Function Documentation	513
6.77.1.1	generate_main	513
6.77.1.2	output_verilog	513
6.78	debug/debug-unit.c File Reference	514
6.78.1	Define Documentation	515
6.78.1.1	RISCOP_RESET	515
6.78.1.2	RISCOP_STALL	515
6.78.2	Enumeration Type Documentation	516
6.78.2.1	development_interface_address_space	516
6.78.3	Function Documentation	516
6.78.3.1	calculate_watchpoints	516
6.78.3.2	check_debug_unit	516
6.78.3.3	debug_enabled	517
6.78.3.4	debug_gdb_enabled	517
6.78.3.5	debug_get_mem	517
6.78.3.6	debug_get_register	518
6.78.3.7	debug_ignore_exception	518
6.78.3.8	debug_rsp_enabled	518
6.78.3.9	debug_rsp_port	519
6.78.3.10	debug_server_port	519
6.78.3.11	debug_set_chain	519
6.78.3.12	debug_set_mem	520
6.78.3.13	debug_set_register	520
6.78.3.14	debug_vapi_id	521
6.78.3.15	du_reset	521
6.78.3.16	get_devint_reg	521
6.78.3.17	get_devint_reg	521
6.78.3.18	reg_debug_sec	521
6.78.3.19	set_devint_reg	522
6.78.3.20	set_devint_reg	523
6.78.3.21	set_stall_state	523

---

6.78.4	Variable Documentation	523
6.78.4.1	current_scan_chain	523
6.78.4.2	development	523
6.78.4.3	in_reset	523
6.79	debug/debug-unit.h File Reference	524
6.79.1	Enumeration Type Documentation	524
6.79.1.1	debug_scan_chain_ids	524
6.79.1.2	debug_unit_action	525
6.79.2	Function Documentation	525
6.79.2.1	check_debug_unit	525
6.79.2.2	debug_get_register	525
6.79.2.3	debug_ignore_exception	526
6.79.2.4	debug_set_chain	526
6.79.2.5	debug_set_register	526
6.79.2.6	du_reset	527
6.79.2.7	reg_debug_sec	527
6.79.2.8	set_stall_state	528
6.80	debug/gdb.h File Reference	529
6.80.1	Enumeration Type Documentation	529
6.80.1.1	or1k_jtag_errors	529
6.80.1.2	or1k_jtag_proxy_protocol_commands	530
6.81	debug/gdbcomm.c File Reference	531
6.81.1	Function Documentation	532
6.81.1.1	block_jtag	532
6.81.1.2	gdb_read	532
6.81.1.3	gdb_request	532
6.81.1.4	gdb_write	533
6.81.1.5	gdbcomm_init	533
6.81.1.6	get_server_socket	533
6.81.1.7	handle_server_socket	533
6.81.1.8	jtag_request	534
6.81.1.9	protocol_clean	534
6.81.2	Variable Documentation	534
6.81.2.1	gdb_fd	534
6.81.2.2	server_fd	534
6.81.2.3	server_ip	534



---

6.81.2.4	server_port	534
6.81.2.5	tcp_level	534
6.82	debug/gdbcomm.h File Reference	535
6.82.1	Enumeration Type Documentation	535
6.82.1.1	boolean	535
6.82.2	Function Documentation	535
6.82.2.1	block_jtag	535
6.82.2.2	gdbcomm_init	535
6.82.2.3	handle_server_socket	536
6.83	debug/rsp-server.c File Reference	537
6.83.1	Define Documentation	539
6.83.1.1	GDB_BUF_MAX	539
6.83.1.2	MP_HASH_SIZE	539
6.83.1.3	NPC_REGNUM	540
6.83.1.4	NUM_REGS	540
6.83.1.5	OR1K_TRAP_INSTR	540
6.83.1.6	OR1KSIM_RSP_PROTOCOL	540
6.83.1.7	OR1KSIM_RSP_SERVICE	540
6.83.1.8	OR1KSIM_TID	540
6.83.1.9	PPC_REGNUM	540
6.83.1.10	SR_REGNUM	540
6.83.2	Enumeration Type Documentation	540
6.83.2.1	mp_type	540
6.83.2.2	target_signal	541
6.83.3	Function Documentation	541
6.83.3.1	ascii2hex	541
6.83.3.2	get_packet	541
6.83.3.3	get_rsp_char	542
6.83.3.4	handle_rsp	542
6.83.3.5	hex	543
6.83.3.6	hex2ascii	544
6.83.3.7	hex2reg	544
6.83.3.8	mp_hash_add	544
6.83.3.9	mp_hash_delete	545
6.83.3.10	mp_hash_init	545
6.83.3.11	mp_hash_lookup	545

---

6.83.3.12	put_packet	545
6.83.3.13	put_rsp_char	546
6.83.3.14	put_str_packet	546
6.83.3.15	reg2hex	546
6.83.3.16	rsp_client_close	547
6.83.3.17	rsp_client_request	547
6.83.3.18	rsp_command	548
6.83.3.19	rsp_continue	549
6.83.3.20	rsp_continue_generic	550
6.83.3.21	rsp_continue_with_signal	550
6.83.3.22	rsp_exception	550
6.83.3.23	rsp_get_client	550
6.83.3.24	rsp_init	551
6.83.3.25	rsp_insert_matchpoint	551
6.83.3.26	rsp_query	552
6.83.3.27	rsp_read_all_regs	553
6.83.3.28	rsp_read_mem	553
6.83.3.29	rsp_read_reg	553
6.83.3.30	rsp_remove_matchpoint	554
6.83.3.31	rsp_report_exception	554
6.83.3.32	rsp_restart	555
6.83.3.33	rsp_set	555
6.83.3.34	rsp_step	555
6.83.3.35	rsp_step_generic	555
6.83.3.36	rsp_step_with_signal	556
6.83.3.37	rsp_unescape	556
6.83.3.38	rsp_vpkt	556
6.83.3.39	rsp_write_all_regs	557
6.83.3.40	rsp_write_mem	557
6.83.3.41	rsp_write_mem_bin	558
6.83.3.42	rsp_write_reg	558
6.83.3.43	set_npc	559
6.83.4	Variable Documentation	559
6.83.4.1	client_fd	559
6.83.4.2	client_waiting	559
6.83.4.3	hexchars	559

6.83.4.4	mp_hash	559
6.83.4.5	proto_num	559
6.83.4.6	rsp	559
6.83.4.7	sigval	560
6.83.4.8	start_addr	560
6.84	debug/rsp-server.h File Reference	561
6.84.1	Function Documentation	561
6.84.1.1	handle_rsp	561
6.84.1.2	rsp_exception	562
6.84.1.3	rsp_init	563
6.85	libtoplevel.c File Reference	564
6.85.1	Function Documentation	565
6.85.1.1	internal_or1ksim_time	565
6.85.1.2	or1ksim_clock_rate	565
6.85.1.3	or1ksim_get_time_period	565
6.85.1.4	or1ksim_init	565
6.85.1.5	or1ksim_interrupt	568
6.85.1.6	or1ksim_interrupt_clear	568
6.85.1.7	or1ksim_interrupt_set	568
6.85.1.8	or1ksim_is_le	568
6.85.1.9	or1ksim_reset_duration	569
6.85.1.10	or1ksim_run	569
6.85.1.11	or1ksim_set_time_point	569
6.86	mainpage File Reference	571
6.86.1	Detailed Description	571
6.87	mmu/dmmu.c File Reference	572
6.87.1	Function Documentation	573
6.87.1.1	dmmu_enabled	573
6.87.1.2	dmmu_end_sec	573
6.87.1.3	dmmu_entsize	573
6.87.1.4	dmmu_find_tlbmr	574
6.87.1.5	dmmu_hitdelay	574
6.87.1.6	dmmu_missdelay	574
6.87.1.7	dmmu_nsets	574
6.87.1.8	dmmu_nways	574
6.87.1.9	dmmu_pagesize	574

6.87.1.10	dmmu_start_sec	575
6.87.1.11	dmmu_translate	575
6.87.1.12	dmmu_ustates	575
6.87.1.13	dtlb_status	576
6.87.1.14	peek_into_dtlb	576
6.87.1.15	reg_dmmu_sec	576
6.87.2	Variable Documentation	577
6.87.2.1	dmmu_state	577
6.88	mmu/dmmu.h File Reference	578
6.88.1	Define Documentation	579
6.88.1.1	DADDR_PAGE	579
6.88.2	Function Documentation	579
6.88.2.1	dmmu_simulate_tlb	579
6.88.2.2	dmmu_translate	579
6.88.2.3	peek_into_dtlb	579
6.88.2.4	reg_dmmu_sec	580
6.88.3	Variable Documentation	580
6.88.3.1	dmmu_state	580
6.89	mmu/immu.c File Reference	581
6.89.1	Function Documentation	582
6.89.1.1	immu_enabled	582
6.89.1.2	immu_end_sec	582
6.89.1.3	immu_entrysize	582
6.89.1.4	immu_find_tlbmr	583
6.89.1.5	immu_hitdelay	583
6.89.1.6	immu_missdelay	583
6.89.1.7	immu_nsets	583
6.89.1.8	immu_nways	583
6.89.1.9	immu_pagesize	583
6.89.1.10	immu_start_sec	584
6.89.1.11	immu_translate	584
6.89.1.12	immu_ustates	584
6.89.1.13	itlb_status	585
6.89.1.14	peek_into_itlb	585
6.89.1.15	reg_immu_sec	585
6.89.2	Variable Documentation	585

---

6.89.2.1	immu_state	585
6.90	mmu/immu.h File Reference	586
6.90.1	Define Documentation	587
6.90.1.1	IADDR_PAGE	587
6.90.2	Function Documentation	587
6.90.2.1	immu_simulate_tlb	587
6.90.2.2	immu_translate	587
6.90.2.3	peek_into_itlb	587
6.90.2.4	reg_immu_sec	588
6.90.3	Variable Documentation	588
6.90.3.1	immu_state	588
6.91	mprofiler.c File Reference	589
6.91.1	Define Documentation	590
6.91.1.1	BUF_SIZE	590
6.91.1.2	HASH_FUNC	590
6.91.1.3	HASH_SIZE	590
6.91.1.4	MODE_ACCESS	590
6.91.1.5	MODE_DETAIL	590
6.91.1.6	MODE_PRETTY	590
6.91.1.7	MODE_WIDTH	590
6.91.2	Function Documentation	590
6.91.2.1	hash_add	590
6.91.2.2	hash_get	590
6.91.2.3	init	590
6.91.2.4	main_mprofiler	590
6.91.2.5	nbits	591
6.91.2.6	printout	591
6.91.2.7	read_file	591
6.91.3	Variable Documentation	591
6.91.3.1	end_addr	591
6.91.3.2	fprof	591
6.91.3.3	group_bits	591
6.91.3.4	hash	591
6.91.3.5	start_addr	592
6.92	mprofiler.h File Reference	593
6.92.1	Function Documentation	593

6.92.1.1	main_mprofiler	593
6.93	or1ksim.h File Reference	594
6.93.1	Enumeration Type Documentation	594
6.93.1.1	or1ksim_rc	594
6.93.2	Function Documentation	594
6.93.2.1	or1ksim_clock_rate	594
6.93.2.2	or1ksim_get_time_period	595
6.93.2.3	or1ksim_init	595
6.93.2.4	or1ksim_interrupt	595
6.93.2.5	or1ksim_interrupt_clear	595
6.93.2.6	or1ksim_interrupt_set	595
6.93.2.7	or1ksim_is_le	596
6.93.2.8	or1ksim_reset_duration	596
6.93.2.9	or1ksim_run	596
6.93.2.10	or1ksim_set_time_point	597
6.94	peripheral/16450.c File Reference	598
6.94.1	Define Documentation	601
6.94.1.1	MAX_SKEW	601
6.94.1.2	MIN	601
6.94.1.3	UART_ADDR_SPACE	601
6.94.1.4	UART_BREAK_COUNT	601
6.94.1.5	UART_CHAR_TIMEOUT	601
6.94.1.6	UART_CLOCK_DIVIDER	601
6.94.1.7	UART_DLH	601
6.94.1.8	UART_DLL	601
6.94.1.9	UART_FCR	601
6.94.1.10	UART_FCR_FIE	601
6.94.1.11	UART_FCR_RRXFI	601
6.94.1.12	UART_FCR_RTXFI	601
6.94.1.13	UART_FGETC_SLOWDOWN	601
6.94.1.14	UART_FIFO_TRIGGER	601
6.94.1.15	UART_IER	604
6.94.1.16	UART_IER_MSI	604
6.94.1.17	UART_IER_RDI	604
6.94.1.18	UART_IER_RLSI	604
6.94.1.19	UART_IER_THRI	604

---

6.94.1.20	UART_IIR	604
6.94.1.21	UART_IIR_CTI	604
6.94.1.22	UART_IIR_ID	604
6.94.1.23	UART_IIR_MSI	604
6.94.1.24	UART_IIR_NO_INT	604
6.94.1.25	UART_IIR_RDI	604
6.94.1.26	UART_IIR_RLSI	604
6.94.1.27	UART_IIR_THRI	604
6.94.1.28	UART_LCR	604
6.94.1.29	UART_LCR_DLAB	604
6.94.1.30	UART_LCR_EPAR	604
6.94.1.31	UART_LCR_PARITY	604
6.94.1.32	UART_LCR_RESET	604
6.94.1.33	UART_LCR_SBC	604
6.94.1.34	UART_LCR_SPAR	604
6.94.1.35	UART_LCR_STOP	604
6.94.1.36	UART_LCR_WLEN5	604
6.94.1.37	UART_LCR_WLEN6	604
6.94.1.38	UART_LCR_WLEN7	604
6.94.1.39	UART_LCR_WLEN8	604
6.94.1.40	UART_LSR	604
6.94.1.41	UART_LSR_BREAK	604
6.94.1.42	UART_LSR_FRAME	604
6.94.1.43	UART_LSR_OVRRUN	604
6.94.1.44	UART_LSR_PARITY	604
6.94.1.45	UART_LSR_RDRDY	604
6.94.1.46	UART_LSR_RXERR	604
6.94.1.47	UART_LSR_TXBUFE	604
6.94.1.48	UART_LSR_TXSERE	604
6.94.1.49	UART_MAX_FIFO_LEN	604
6.94.1.50	UART_MCR	605
6.94.1.51	UART_MCR_AUX1	605
6.94.1.52	UART_MCR_AUX2	605
6.94.1.53	UART_MCR_DTR	605
6.94.1.54	UART_MCR_LOOP	605
6.94.1.55	UART_MCR_RTS	605

6.94.1.56	UART_MSR	605
6.94.1.57	UART_MSR_CTS	605
6.94.1.58	UART_MSR_DCD	605
6.94.1.59	UART_MSR_DCTS	605
6.94.1.60	UART_MSR_DDCD	605
6.94.1.61	UART_MSR_DDSR	605
6.94.1.62	UART_MSR_DSR	605
6.94.1.63	UART_MSR_RI	605
6.94.1.64	UART_MSR_TERI	605
6.94.1.65	UART_RXBUF	605
6.94.1.66	UART_SCR	605
6.94.1.67	UART_TXBUF	605
6.94.1.68	UART_VALID_FCR	605
6.94.1.69	UART_VALID_IER	605
6.94.1.70	UART_VALID_IIR	605
6.94.1.71	UART_VALID_LCR	605
6.94.1.72	UART_VALID_LSR	605
6.94.1.73	UART_VALID_MCR	605
6.94.1.74	UART_VALID_MSR	605
6.94.1.75	UART_VAPI_BUF_LEN	605
6.94.2	Function Documentation	607
6.94.2.1	char_clks	607
6.94.2.2	reg_uart_sec	607
6.94.2.3	send_char	608
6.94.2.4	uart_16550	608
6.94.2.5	uart_add_char	608
6.94.2.6	uart_baseaddr	608
6.94.2.7	uart_channel	608
6.94.2.8	uart_char_clock	609
6.94.2.9	uart_check_char	609
6.94.2.10	uart_check_rdi	609
6.94.2.11	uart_check_rlsi	610
6.94.2.12	uart_clear_int	610
6.94.2.13	uart_enabled	611
6.94.2.14	uart_int_cti	611
6.94.2.15	uart_int_msi	611



---

6.94.2.16	uart_int_rdi	612
6.94.2.17	uart_int_rlsi	612
6.94.2.18	uart_int_thri	613
6.94.2.19	uart_irq	613
6.94.2.20	uart_jitter	613
6.94.2.21	uart_loopback	613
6.94.2.22	uart_newway	614
6.94.2.23	uart_next_int	614
6.94.2.24	uart_read_byte	614
6.94.2.25	uart_recv_break	614
6.94.2.26	uart_recv_break_start	615
6.94.2.27	uart_recv_break_stop	615
6.94.2.28	uart_recv_char	615
6.94.2.29	uart_reset	616
6.94.2.30	uart_sched_recv_check	616
6.94.2.31	uart_sec_end	617
6.94.2.32	uart_sec_start	617
6.94.2.33	uart_send_break	618
6.94.2.34	uart_status	618
6.94.2.35	uart_tx_send	618
6.94.2.36	uart_vapi_cmd	619
6.94.2.37	uart_vapi_id	619
6.94.2.38	uart_vapi_read	619
6.94.2.39	uart_write_byte	619
6.95	peripheral/16450.h File Reference	620
6.95.1	Function Documentation	622
6.95.1.1	reg_uart_sec	622
6.95.1.2	uart_reset	623
6.95.1.3	uart_status	623
6.96	peripheral/atacmd.h File Reference	624
6.96.1	Define Documentation	627
6.96.1.1	CFA_DISABLE_8BIT_PIO_TRANSFER_MODE	627
6.96.1.2	CFA_DISABLE_POWER_MODE1	627
6.96.1.3	CFA_ENABLE_8BIT_PIO_TRANSFER_MODE	627
6.96.1.4	CFA_ENABLE_POWER_MODE1	627
6.96.1.5	CFA_ERASE_SECTORS	627

---

6.96.1.6	CFA_REQUEST_EXTENDED_ERROR_CODE	627
6.96.1.7	CFA_TRANSLATE_SECTOR	627
6.96.1.8	CFA_WRITE_MULTIPLE_WITHOUT_ERASE	627
6.96.1.9	CFA_WRITE_SECTORS_WITHOUT_ERASE	627
6.96.1.10	CHECK_POWER_MODE	627
6.96.1.11	DEVICE_RESET	627
6.96.1.12	DISABLE_ADVANCED_POWER_MANAGEMENT	627
6.96.1.13	DISABLE_MEDIA_STATUS_NOTIFICATION	627
6.96.1.14	DISABLE_POWERUP_IN_STANDBY_FEATURE_SET	627
6.96.1.15	DISABLE_READ_LOOKAHEAD	627
6.96.1.16	DISABLE_RELEASE_INTERRUPT	627
6.96.1.17	DISABLE_REVERTING_TO_POWERON_DEFAULTS	627
6.96.1.18	DISABLE_SERVICE_INTERRUPT	627
6.96.1.19	DISABLE_WRITE_CACHE	627
6.96.1.20	DOWNLOAD_MICROCODE	627
6.96.1.21	ENABLE_ADVANCED_POWER_MANAGEMENT	627
6.96.1.22	ENABLE_MEDIA_STATUS_NOTIFICATION	627
6.96.1.23	ENABLE_POWERUP_IN_STANDBY_FEATURE_SET	627
6.96.1.24	ENABLE_READ_LOOKAHEAD_FEATURE	627
6.96.1.25	ENABLE_RELEASE_INTERRUPT	627
6.96.1.26	ENABLE_REVERTING_TO_POWERON_DEFAULTS	627
6.96.1.27	ENABLE_SERVICE_INTERRUPT	627
6.96.1.28	ENABLE_WRITE_CACHE	627
6.96.1.29	EXECUTE_DEVICE_DIAGNOSTICS	627
6.96.1.30	FLUSH_CACHE	627
6.96.1.31	GET_MEDIA_STATUS	627
6.96.1.32	IDENTIFY_DEVICE	627
6.96.1.33	IDENTIFY_PACKET_DEVICE	627
6.96.1.34	IDLE	627
6.96.1.35	IDLE_IMMEDIATE	627
6.96.1.36	INITIALIZE_DEVICE_PARAMETERS	627
6.96.1.37	MEDIA_EJECT	627
6.96.1.38	MEDIA_LOCK	627
6.96.1.39	MEDIA_UNLOCK	627
6.96.1.40	NOP	627
6.96.1.41	PACKET	627

6.96.1.42 POWERUP_IN_STANDBY_FEATURE_SET_SPINUP . . . . .	627
6.96.1.43 READ_BUFFER . . . . .	627
6.96.1.44 READ_DMA . . . . .	627
6.96.1.45 READ_DMA_QUEUED . . . . .	627
6.96.1.46 READ_MULTIPLE . . . . .	627
6.96.1.47 READ_NATIVE_MAX_ADDRESS . . . . .	627
6.96.1.48 READ_SECTOR . . . . .	627
6.96.1.49 READ_SECTORS . . . . .	627
6.96.1.50 READ_VERIFY_SECTOR . . . . .	627
6.96.1.51 READ_VERIFY_SECTORS . . . . .	627
6.96.1.52 SECURITY_DISABLE_PASSWORD . . . . .	627
6.96.1.53 SECURITY_ERASE_PREPARE . . . . .	627
6.96.1.54 SECURITY_ERASE_UNIT . . . . .	627
6.96.1.55 SECURITY_FREEZE_LOCK . . . . .	627
6.96.1.56 SECURITY_SET_PASSWORD . . . . .	627
6.96.1.57 SECURITY_UNLOCK . . . . .	627
6.96.1.58 SEEK . . . . .	627
6.96.1.59 SERVICE . . . . .	627
6.96.1.60 SET_FEATURES . . . . .	627
6.96.1.61 SET_MAX . . . . .	627
6.96.1.62 SET_MAX_ADDRESS . . . . .	627
6.96.1.63 SET_MAX_FREEZE_LOCK . . . . .	627
6.96.1.64 SET_MAX_LOCK . . . . .	627
6.96.1.65 SET_MAX_SET_PASSWORD . . . . .	627
6.96.1.66 SET_MAX_UNLOCK . . . . .	627
6.96.1.67 SET_MULTIPLE_MODE . . . . .	627
6.96.1.68 SET_TRANSFER_MODE_SECTOR_COUNT_REG . . . . .	627
6.96.1.69 SLEEP . . . . .	627
6.96.1.70 SMART . . . . .	627
6.96.1.71 SMART_ATTRIBITE_AUTOSAVE . . . . .	627
6.96.1.72 SMART_DISABLE_OPERATIONS . . . . .	627
6.96.1.73 SMART_ENABLE_OPERATIONS . . . . .	627
6.96.1.74 SMART_EXECUTE_OFFLINE_IMMEDIATE . . . . .	627
6.96.1.75 SMART_READ_DATA . . . . .	627
6.96.1.76 SMART_READ_LOG . . . . .	627
6.96.1.77 SMART_RETURN_STATUS . . . . .	627

6.96.1.78	SMART_SAVE_ATTRIBUTE_VALUES	627
6.96.1.79	SMART_WRITE_LOG	627
6.96.1.80	STANDBY	627
6.96.1.81	STANDBY_IMMEDIATE	627
6.96.1.82	WRITE_BUFFER	627
6.96.1.83	WRITE_DMA	627
6.96.1.84	WRITE_DMA_QUEUED	627
6.96.1.85	WRITE_MULTIPLE	627
6.96.1.86	WRITE_SECTOR	627
6.96.1.87	WRITE_SECTORS	627
6.97	peripheral/atadevice-cmdi.c File Reference	628
6.97.1	Function Documentation	629
6.97.1.1	ata_calc_lba	629
6.97.1.2	ata_cmd_complete	629
6.97.1.3	ata_device_execute_cmd	629
6.97.1.4	ata_device_reset_cmd	629
6.97.1.5	ata_execute_device_diagnostics_cmd	630
6.97.1.6	ata_identify_device_cmd	630
6.97.1.7	ata_initialize_device_parameters_cmd	630
6.97.1.8	ata_read_native_max_addr	630
6.97.1.9	ata_read_sect	630
6.97.1.10	ata_read_sectors_cmd	631
6.97.1.11	ata_set_device_signature	631
6.97.1.12	ata_set_features	631
6.97.1.13	ata_set_sect	631
6.97.1.14	ata_write_sect	631
6.97.1.15	ata_write_sectors	632
6.98	peripheral/atadevice-cmdi.h File Reference	633
6.98.1	Define Documentation	636
6.98.1.1	BYTES_PER_SECTOR	636
6.98.1.2	MIN_MWDMA_CYCLE_TIME	636
6.98.1.3	MIN_PIO_CYCLE_TIME_IORDY	636
6.98.1.4	MIN_PIO_CYCLE_TIME_NO_IORDY	636
6.98.1.5	QUEUE_DEPTH	636
6.98.1.6	RECOMMENDED_MWDMA_CYCLE_TIME	636
6.98.1.7	SET_FEATURES_REQUIRED_AFTER_POWER_UP	636

---

6.98.1.8	SUPPORT_APM	636
6.98.1.9	SUPPORT_CFA	636
6.98.1.10	SUPPORT_DEVICE_RESET_CMD	636
6.98.1.11	SUPPORT_DOWNLOAD_MICROCODE	636
6.98.1.12	SUPPORT_HOST_PROTECTED_AREA	636
6.98.1.13	SUPPORT_LOOKAHEAD	636
6.98.1.14	SUPPORT_NOP_CMD	636
6.98.1.15	SUPPORT_POWER_MANAGEMENT	636
6.98.1.16	SUPPORT_POWER_UP_IN_STANDBY_MODE	636
6.98.1.17	SUPPORT_READ_BUFFER_CMD	636
6.98.1.18	SUPPORT_READ_WRITE_DMA_QUEUED	636
6.98.1.19	SUPPORT_RELEASE_INTERRUPT	636
6.98.1.20	SUPPORT_REMOVABLE_MEDIA	636
6.98.1.21	SUPPORT_REMOVABLE_MEDIA_NOTIFICATION	636
6.98.1.22	SUPPORT_SECURITY_MODE	636
6.98.1.23	SUPPORT_SERVICE_INTERRUPT	636
6.98.1.24	SUPPORT_SET_MAX	636
6.98.1.25	SUPPORT_SMART	636
6.98.1.26	SUPPORT_WRITE_BUFFER_CMD	636
6.98.1.27	SUPPORT_WRITE_CACHE	636
6.98.2	Function Documentation	636
6.98.2.1	ata_device_execute_cmd	636
6.98.2.2	ata_execute_device_diagnostics_cmd	637
6.99	peripheral/atadevice.c File Reference	638
6.99.1	Function Documentation	639
6.99.1.1	ata_device_do_command_register	639
6.99.1.2	ata_device_do_control_register	639
6.99.1.3	ata_device_hw_reset	639
6.99.1.4	ata_device_init	639
6.99.1.5	ata_device_write	640
6.99.1.6	ata_devices_hw_reset	640
6.99.1.7	ata_devices_init	640
6.99.1.8	ata_devices_read	640
6.99.1.9	ata_devices_write	640
6.99.1.10	open_file	641
6.99.1.11	open_local	641

---

6.100peripheral/atadevice.h File Reference . . . . .	642
6.100.1 Define Documentation . . . . .	645
6.100.1.1 ATA_ASR . . . . .	645
6.100.1.2 ATA_CHR . . . . .	645
6.100.1.3 ATA_CLR . . . . .	645
6.100.1.4 ATA_CR . . . . .	645
6.100.1.5 ATA_DA . . . . .	645
6.100.1.6 ATA_DAR_DS0 . . . . .	645
6.100.1.7 ATA_DAR_DS1 . . . . .	645
6.100.1.8 ATA_DAR_H . . . . .	645
6.100.1.9 ATA_DAR_WTG . . . . .	645
6.100.1.10ATA_DCR . . . . .	645
6.100.1.11ATA_DCR_IEN . . . . .	645
6.100.1.12ATA_DCR_RST . . . . .	645
6.100.1.13ATA_DHR . . . . .	645
6.100.1.14ATA_DHR_DEV . . . . .	645
6.100.1.15ATA_DHR_H . . . . .	645
6.100.1.16ATA_DHR_LBA . . . . .	645
6.100.1.17ATA_DR . . . . .	645
6.100.1.18ATA_ERR . . . . .	645
6.100.1.19ATA_ERR_ABT . . . . .	645
6.100.1.20ATA_ERR_AMN . . . . .	645
6.100.1.21ATA_ERR_BBK . . . . .	645
6.100.1.22ATA_ERR_IDNF . . . . .	645
6.100.1.23ATA_ERR_TON . . . . .	645
6.100.1.24ATA_ERR_UNC . . . . .	645
6.100.1.25ATA_FR . . . . .	645
6.100.1.26ATA_SCR . . . . .	645
6.100.1.27ATA_SNR . . . . .	645
6.100.1.28ATA_SR . . . . .	645
6.100.1.29ATA_SR_BSY . . . . .	645
6.100.1.30ATA_SR_COR . . . . .	645
6.100.1.31ATA_SR_DF . . . . .	645
6.100.1.32ATA_SR_DRDY . . . . .	645
6.100.1.33ATA_SR_DRQ . . . . .	645
6.100.1.34ATA_SR_DSC . . . . .	645

6.100.1.35	ATA_SR_ERR	645
6.100.1.36	ATA_SR_IDX	645
6.100.1.37	ATA_STATE_HW_RST	645
6.100.1.38	ATA_STATE_IDLE	645
6.100.1.39	ATA_STATE_SW_RST	645
6.100.1.40	TYPE_FILE	645
6.100.1.41	TYPE_LOCAL	645
6.100.1.42	TYPE_NO_CONNECT	645
6.100.2	Function Documentation	645
6.100.2.1	ata_devices_hw_reset	645
6.100.2.2	ata_devices_init	646
6.100.2.3	ata_devices_read	646
6.100.2.4	ata_devices_write	646
6.101	peripheral/atahost.c File Reference	647
6.101.1	Define Documentation	649
6.101.1.1	DMA_MODE0_TD	649
6.101.1.2	DMA_MODE0_TEOC	649
6.101.1.3	DMA_MODE0_TM	649
6.101.1.4	PIO_MODE0_T1	649
6.101.1.5	PIO_MODE0_T2	649
6.101.1.6	PIO_MODE0_T4	649
6.101.1.7	PIO_MODE0_TEOC	649
6.101.2	Function Documentation	649
6.101.2.1	ata_baseaddr	649
6.101.2.2	ata_dev_id	649
6.101.2.3	ata_dma_mode0_td	649
6.101.2.4	ata_dma_mode0_tioc	649
6.101.2.5	ata_dma_mode0_tm	649
6.101.2.6	ata_enabled	649
6.101.2.7	ata_enddevice	649
6.101.2.8	ata_file	649
6.101.2.9	ata_firmware	650
6.101.2.10	ata_heads	650
6.101.2.11	ata_int	650
6.101.2.12	ata_irq	650
6.101.2.13	ata_mwdma	650

6.101.2.14	ata_packet	650
6.101.2.15	ata_pio	650
6.101.2.16	ata_pio_mode0_t1	651
6.101.2.17	ata_pio_mode0_t2	651
6.101.2.18	ata_pio_mode0_t4	651
6.101.2.19	ata_pio_mode0_teoc	651
6.101.2.20	ata_read32	651
6.101.2.21	ata_reset	651
6.101.2.22	ata_rev	651
6.101.2.23	ata_sec_end	652
6.101.2.24	ata_sec_start	652
6.101.2.25	ata_sectors	653
6.101.2.26	ata_size	653
6.101.2.27	ata_start_device	653
6.101.2.28	ata_status	653
6.101.2.29	ata_type	653
6.101.2.30	ata_write32	653
6.101.2.31	reg_ata_sec	655
6.101.3	Variable Documentation	656
6.101.3.1	conf_dev	656
6.102	peripheral/atahost.h File Reference	657
6.102.1	Define Documentation	660
6.102.1.1	ATA_ADDR_SPACE	660
6.102.1.2	ATA_BELECO	660
6.102.1.3	ATA_BELEC1	660
6.102.1.4	ATA_CTRL	660
6.102.1.5	ATA_DEVID	660
6.102.1.6	ata_dma_delay	660
6.102.1.7	ATA_DMA_EN	660
6.102.1.8	ATA_DMA_RD	660
6.102.1.9	ATA_DMA_TIP	660
6.102.1.10	ATA_DMA_WR	660
6.102.1.11	IATA_DMARQ	660
6.102.1.12	ATA_DRBE	660
6.102.1.13	ATA_DTBF	660
6.102.1.14	ATA_DTR0	660



---

6.102.1.15ATA_DTR1 . . . . .	660
6.102.1.16ATA_FTE0 . . . . .	660
6.102.1.17ATA_FTE1 . . . . .	660
6.102.1.18ATA_IDE_EN . . . . .	660
6.102.1.19ATA_IDEIS . . . . .	660
6.102.1.20ATA_IORDY . . . . .	660
6.102.1.21ATA_IORDY_FTE0 . . . . .	660
6.102.1.22ATA_IORDY_FTE1 . . . . .	660
6.102.1.23ATA_PCTR . . . . .	660
6.102.1.24ATA_PFTR0 . . . . .	660
6.102.1.25ATA_PFTR1 . . . . .	660
6.102.1.26ata_pio_delay . . . . .	660
6.102.1.27ATA_PIO_TIP . . . . .	660
6.102.1.28ATA_PWPP . . . . .	660
6.102.1.29ATA_PWPPF . . . . .	660
6.102.1.30ATA_REVNO . . . . .	660
6.102.1.31ATA_RST . . . . .	660
6.102.1.32ATA_RXB . . . . .	660
6.102.1.33ATA_STAT . . . . .	660
6.102.1.34ATA_T1 . . . . .	660
6.102.1.35ATA_T2 . . . . .	660
6.102.1.36ATA_T4 . . . . .	660
6.102.1.37ATA_TD . . . . .	660
6.102.1.38ATA_TEOC . . . . .	660
6.102.1.39ATA_TM . . . . .	660
6.102.1.40ATA_TXB . . . . .	660
6.102.1.4 lis_ata_hostadr . . . . .	660
6.102.2 Function Documentation . . . . .	660
6.102.2.1 ata_int . . . . .	660
6.102.2.2 reg_ata_sec . . . . .	662
6.103 peripheral/channels/channel.c File Reference . . . . .	663
6.103.1 Function Documentation . . . . .	664
6.103.1.1 channel_close . . . . .	664
6.103.1.2 channel_init . . . . .	664
6.103.1.3 channel_open . . . . .	664
6.103.1.4 channel_read . . . . .	664

---

6.103.1.5	channel_write	664
6.103.1.6	find_channel_factory	664
6.103.2	Variable Documentation	664
6.103.2.1	head	664
6.103.2.2	preloaded	664
6.104	peripheral/channels/channel.h File Reference	665
6.104.1	Function Documentation	665
6.104.1.1	channel_close	665
6.104.1.2	channel_init	665
6.104.1.3	channel_open	665
6.104.1.4	channel_read	665
6.104.1.5	channel_write	665
6.105	peripheral/channels/fd.c File Reference	666
6.105.1	Function Documentation	667
6.105.1.1	fd_init	667
6.105.1.2	fd_isok	667
6.105.1.3	fd_read	667
6.105.1.4	fd_status	667
6.105.1.5	fd_status_fd	667
6.105.1.6	fd_write	667
6.105.2	Variable Documentation	667
6.105.2.1	fd_channel_ops	667
6.106	peripheral/channels/fd.h File Reference	668
6.106.1	Function Documentation	668
6.106.1.1	fd_read	668
6.106.1.2	fd_write	668
6.106.2	Variable Documentation	668
6.106.2.1	fd_channel_ops	668
6.107	peripheral/channels/file.c File Reference	669
6.107.1	Function Documentation	670
6.107.1.1	file_close	670
6.107.1.2	file_free	670
6.107.1.3	file_init	670
6.107.1.4	file_open	670
6.107.2	Variable Documentation	670
6.107.2.1	file_channel_ops	670

---

6.108	peripheral/channels/file.h File Reference	671
6.108.1	Variable Documentation	671
6.108.1.1	file_channel_ops	671
6.109	peripheral/channels/tcp.c File Reference	672
6.109.1	Function Documentation	673
6.109.1.1	tcp_init	673
6.109.1.2	tcp_open	673
6.109.1.3	tcp_read	673
6.109.1.4	tcp_write	673
6.109.1.5	wait_for_tcp_connect	673
6.109.2	Variable Documentation	673
6.109.2.1	tcp_channel_ops	673
6.110	peripheral/channels/tcp.h File Reference	674
6.110.1	Variable Documentation	674
6.110.1.1	tcp_channel_ops	674
6.111	peripheral/channels/tty.c File Reference	675
6.111.1	Define Documentation	676
6.111.1.1	DEFAULT_BAUD	676
6.111.1.2	DEFAULT_TTY_DEVICE	676
6.111.2	Function Documentation	676
6.111.2.1	parse_baud	676
6.111.2.2	tty_init	676
6.111.2.3	tty_open	676
6.111.3	Variable Documentation	676
6.111.3.1	baud_table	676
6.111.3.2	name	676
6.111.3.3	tty_channel_ops	676
6.111.3.4	value	676
6.112	peripheral/channels/tty.h File Reference	677
6.112.1	Variable Documentation	677
6.112.1.1	tty_channel_ops	677
6.113	peripheral/channels/xterm.c File Reference	678
6.113.1	Define Documentation	679
6.113.1.1	MAX_XTERM_ARGS	679
6.113.2	Function Documentation	679
6.113.2.1	basename	679

6.113.2.2	xterm_close	679
6.113.2.3	xterm_init	679
6.113.2.4	xterm_open	679
6.113.3	Variable Documentation	679
6.113.3.1	xterm_channel_ops	679
6.114	peripheral/channels/xterm.h File Reference	680
6.114.1	Variable Documentation	680
6.114.1.1	xterm_channel_ops	680
6.115	peripheral/crc32.c File Reference	681
6.115.1	Function Documentation	681
6.115.1.1	crc32	681
6.115.1.2	crc32_close	681
6.115.1.3	crc32_feed_bytes	681
6.115.1.4	crc32_init	681
6.115.2	Variable Documentation	681
6.115.2.1	crc32_table	681
6.116	peripheral/crc32.h File Reference	682
6.116.1	Function Documentation	682
6.116.1.1	crc32	682
6.116.1.2	crc32_close	682
6.116.1.3	crc32_feed_bytes	682
6.116.1.4	crc32_init	682
6.117	peripheral/dma-defs.h File Reference	683
6.117.1	Define Documentation	685
6.117.1.1	DMA_ADDR_SPACE	685
6.117.1.2	DMA_CH_A0	685
6.117.1.3	DMA_CH_A0_ADDR_OFFSET	685
6.117.1.4	DMA_CH_A0_ADDR_WIDTH	685
6.117.1.5	DMA_CH_A1	685
6.117.1.6	DMA_CH_A1_ADDR_OFFSET	685
6.117.1.7	DMA_CH_A1_ADDR_WIDTH	685
6.117.1.8	DMA_CH_AM0	685
6.117.1.9	DMA_CH_AM0_MASK_OFFSET	685
6.117.1.10	DMA_CH_AM0_MASK_WIDTH	685
6.117.1.11	DMA_CH_AM1	685
6.117.1.12	DMA_CH_AM1_MASK_OFFSET	685

6.117.1.13	DMA_CH_AM1_MASK_WIDTH	685
6.117.1.14	DMA_CH_BASE	685
6.117.1.15	DMA_CH_CSR	687
6.117.1.16	DMA_CH_CSR_ARS_OFFSET	687
6.117.1.17	DMA_CH_CSR_BUSY_OFFSET	687
6.117.1.18	DMA_CH_CSR_CH_EN_OFFSET	687
6.117.1.19	DMA_CH_CSR_DONE_OFFSET	687
6.117.1.20	DMA_CH_CSR_DST_SEL_OFFSET	687
6.117.1.21	DMA_CH_CSR_ERR_OFFSET	687
6.117.1.22	DMA_CH_CSR_INC_DST_OFFSET	687
6.117.1.23	DMA_CH_CSR_INC_SRC_OFFSET	687
6.117.1.24	DMA_CH_CSR_INE_CHK_DONE_OFFSET	687
6.117.1.25	DMA_CH_CSR_INE_DONE_OFFSET	687
6.117.1.26	DMA_CH_CSR_INE_ERR_OFFSET	687
6.117.1.27	DMA_CH_CSR_INT_CHUNK_DONE_OFFSET	687
6.117.1.28	DMA_CH_CSR_INT_DONE_OFFSET	687
6.117.1.29	DMA_CH_CSR_INT_ERR_OFFSET	687
6.117.1.30	DMA_CH_CSR_MODE_OFFSET	687
6.117.1.31	DMA_CH_CSR_PRIORITY_OFFSET	687
6.117.1.32	DMA_CH_CSR_PRIORITY_WIDTH	687
6.117.1.33	DMA_CH_CSR_RESERVED_OFFSET	687
6.117.1.34	DMA_CH_CSR_RESERVED_WIDTH	687
6.117.1.35	DMA_CH_CSR_REST_EN_OFFSET	687
6.117.1.36	DMA_CH_CSR_SRC_SEL_OFFSET	687
6.117.1.37	DMA_CH_CSR_STOP_OFFSET	687
6.117.1.38	DMA_CH_CSR_SZ_WB_OFFSET	687
6.117.1.39	DMA_CH_CSR_USE_ED_OFFSET	687
6.117.1.40	DMA_CH_CSR_WRITE_MASK	687
6.117.1.41	DMA_CH_DESC	687
6.117.1.42	DMA_CH_DESC_ADDR_OFFSET	687
6.117.1.43	DMA_CH_DESC_ADDR_WIDTH	687
6.117.1.44	DMA_CH_SIZE	687
6.117.1.45	DMA_CH_SWPTR	689
6.117.1.46	DMA_CH_SWPTR_EN_OFFSET	689
6.117.1.47	DMA_CH_SWPTR_PTR_OFFSET	689
6.117.1.48	DMA_CH_SWPTR_PTR_WIDTH	689

6.117.1.49	DMA_CH_SZ	689
6.117.1.50	DMA_CH_SZ_CHK_SZ_OFFSET	689
6.117.1.51	DMA_CH_SZ_CHK_SZ_WIDTH	689
6.117.1.52	DMA_CH_SZ_TOT_SZ_OFFSET	689
6.117.1.53	DMA_CH_SZ_TOT_SZ_WIDTH	689
6.117.1.54	DMA_CSR	689
6.117.1.55	DMA_CSR_PAUSE_OFFSET	689
6.117.1.56	DMA_DESC_ADR0	689
6.117.1.57	DMA_DESC_ADR1	689
6.117.1.58	DMA_DESC_CSR	689
6.117.1.59	DMA_DESC_CSR_DST_SEL_OFFSET	689
6.117.1.60	DMA_DESC_CSR_EOL_OFFSET	689
6.117.1.61	DMA_DESC_CSR_INC_DST_OFFSET	689
6.117.1.62	DMA_DESC_CSR_INC_SRC_OFFSET	689
6.117.1.63	DMA_DESC_CSR_SRC_SEL_OFFSET	689
6.117.1.64	DMA_DESC_CSR_TOT_SZ_OFFSET	689
6.117.1.65	DMA_DESC_CSR_TOT_SZ_WIDTH	689
6.117.1.66	DMA_DESC_NEXT	689
6.117.1.67	DMA_INT_MSK_A	689
6.117.1.68	DMA_INT_MSK_B	689
6.117.1.69	DMA_INT_SRC_A	689
6.117.1.70	DMA_INT_SRC_B	689
6.117.1.71	DMA_NUM_CHANNELS	689
6.118	peripheral/dma.c File Reference	690
6.118.1	Define Documentation	692
6.118.1.1	CHANNEL_ND_I	692
6.118.2	Function Documentation	692
6.118.2.1	check_dma_ack_o	692
6.118.2.2	clear_dma_nd_i	692
6.118.2.3	clear_dma_req_i	692
6.118.2.4	dma_baseaddr	692
6.118.2.5	dma_channel_clock	692
6.118.2.6	dma_channel_terminate_transfer	693
6.118.2.7	dma_enabled	693
6.118.2.8	dma_init_transfer	693
6.118.2.9	dma_irq	693

6.118.2.10	<code>dma_load_descriptor</code>	693
6.118.2.11	<code>dma_read32</code>	694
6.118.2.12	<code>dma_read_ch_csr</code>	694
6.118.2.13	<code>dma_reset</code>	694
6.118.2.14	<code>dma_sec_end</code>	694
6.118.2.15	<code>dma_sec_start</code>	694
6.118.2.16	<code>dma_status</code>	695
6.118.2.17	<code>dma_vapi_id</code>	695
6.118.2.18	<code>dma_write32</code>	695
6.118.2.19	<code>dma_write_ch_csr</code>	695
6.118.2.20	<code>find_dma_controller_ch</code>	696
6.118.2.21	<code>masked_increase</code>	696
6.118.2.22	<code>reg_dma_sec</code>	696
6.118.2.23	<code>set_dma_nd_i</code>	696
6.118.2.24	<code>set_dma_req_i</code>	696
6.118.3	Variable Documentation	696
6.118.3.1	<code>dmass</code>	696
6.119	<code>peripheral/dma.h</code> File Reference	697
6.119.1	Function Documentation	698
6.119.1.1	<code>check_dma_ack_o</code>	698
6.119.1.2	<code>clear_dma_nd_i</code>	698
6.119.1.3	<code>clear_dma_req_i</code>	698
6.119.1.4	<code>find_dma_controller_ch</code>	698
6.119.1.5	<code>reg_dma_sec</code>	698
6.119.1.6	<code>set_dma_nd_i</code>	698
6.119.1.7	<code>set_dma_req_i</code>	698
6.120	<code>peripheral/eth.c</code> File Reference	699
6.120.1	Define Documentation	705
6.120.1.1	<code>ETH_ADDR_SPACE</code>	705
6.120.1.2	<code>ETH_ALEN</code>	705
6.120.1.3	<code>ETH_BD_BASE</code>	705
6.120.1.4	<code>ETH_BD_COUNT</code>	705
6.120.1.5	<code>ETH_BD_SPACE</code>	705
6.120.1.6	<code>ETH_CMODER_PASSALL_OFFSET</code>	705
6.120.1.7	<code>ETH_CMODER_RXFLOW_OFFSET</code>	705
6.120.1.8	<code>ETH_CMODER_TXFLOW_OFFSET</code>	705

6.120.1.9	ETH_COLLCONF	705
6.120.1.10	ETH_COLLCONF_COLLVALID_OFFSET	705
6.120.1.11	ETH_COLLCONF_COLLVALID_WIDTH	705
6.120.1.12	ETH_COLLCONF_MAXRET_OFFSET	705
6.120.1.13	ETH_COLLCONF_MAXRET_WIDTH	705
6.120.1.14	ETH_CTRLMODER	705
6.120.1.15	ETH_DMA_RX_TX	705
6.120.1.16	ETH_HASH0	705
6.120.1.17	ETH_HASH1	705
6.120.1.18	ETH_INT_MASK	705
6.120.1.19	ETH_INT_MASK_BUSY_M_OFFSET	705
6.120.1.20	ETH_INT_MASK_RXB_M_OFFSET	705
6.120.1.21	ETH_INT_MASK_RXC_M_OFFSET	705
6.120.1.22	ETH_INT_MASK_RXE_M_OFFSET	705
6.120.1.23	ETH_INT_MASK_TXB_M_OFFSET	705
6.120.1.24	ETH_INT_MASK_TXC_M_OFFSET	705
6.120.1.25	ETH_INT_MASK_TXE_M_OFFSET	705
6.120.1.26	ETH_INT_SOURCE	705
6.120.1.27	ETH_INT_SOURCE_BUSY_OFFSET	705
6.120.1.28	ETH_INT_SOURCE_RXB_OFFSET	705
6.120.1.29	ETH_INT_SOURCE_RXC_OFFSET	705
6.120.1.30	ETH_INT_SOURCE_RXE_OFFSET	705
6.120.1.31	ETH_INT_SOURCE_TXB_OFFSET	705
6.120.1.32	ETH_INT_SOURCE_TXC_OFFSET	705
6.120.1.33	ETH_INT_SOURCE_TXE_OFFSET	705
6.120.1.34	ETH_IPGR1	705
6.120.1.35	ETH_IPGR2	705
6.120.1.36	ETH_IPGT	705
6.120.1.37	ETH_MAC_ADDR0	705
6.120.1.38	ETH_MAC_ADDR1	705
6.120.1.39	ETH_MAXPL	705
6.120.1.40	ETH_MIIADDR_FIAD_OFFSET	705
6.120.1.41	ETH_MIIADDR_FIAD_WIDTH	705
6.120.1.42	ETH_MIIADDR_RGAD_OFFSET	705
6.120.1.43	ETH_MIIADDR_RGAD_WIDTH	705
6.120.1.44	ETH_MIIADDRESS	705



6.120.1.45	ETH_MIICOMM_RSTAT_OFFSET	705
6.120.1.46	ETH_MIICOMM_SCANS_OFFSET	705
6.120.1.47	ETH_MIICOMM_WCDATA_OFFSET	705
6.120.1.48	ETH_MIICOMMAND	705
6.120.1.49	ETH_MIIMODER	705
6.120.1.50	ETH_MIIMODER_CLKDIV_OFFSET	705
6.120.1.51	ETH_MIIMODER_CLKDIV_WIDTH	705
6.120.1.52	ETH_MIIMODER_MRST_OFFSET	705
6.120.1.53	ETH_MIIMODER_NOPRE_OFFSET	705
6.120.1.54	ETH_MIIRX_DATA	705
6.120.1.55	ETH_MIISTAT_BUSY_OFFSET	705
6.120.1.56	ETH_MIISTAT_FAIL_OFFSET	705
6.120.1.57	ETH_MIISTAT_NVALID_OFFSET	705
6.120.1.58	ETH_MIISTATUS	705
6.120.1.59	ETH_MIITX_DATA	705
6.120.1.60	ETH_MODER	705
6.120.1.61	ETH_MODER_BRO_OFFSET	705
6.120.1.62	ETH_MODER_CRCEN_OFFSET	705
6.120.1.63	ETH_MODER_DLYCRCEN_OFFSET	705
6.120.1.64	ETH_MODER_DMAEN_OFFSET	705
6.120.1.65	ETH_MODER_EXDFREN_OFFSET	705
6.120.1.66	ETH_MODER_FULLLD_OFFSET	705
6.120.1.67	ETH_MODER_HUGEN_OFFSET	705
6.120.1.68	ETH_MODER_IAM_OFFSET	705
6.120.1.69	ETH_MODER_IFG_OFFSET	705
6.120.1.70	ETH_MODER_LOOPBCK_OFFSET	705
6.120.1.71	ETH_MODER_NOBCKOF_OFFSET	705
6.120.1.72	ETH_MODER_NOPRE_OFFSET	705
6.120.1.73	ETH_MODER_PAD_OFFSET	705
6.120.1.74	ETH_MODER_PRO_OFFSET	705
6.120.1.75	ETH_MODER_RECSMALL_OFFSET	705
6.120.1.76	ETH_MODER_RST_OFFSET	705
6.120.1.77	ETH_MODER_RXEN_OFFSET	705
6.120.1.78	ETH_MODER_TXEN_OFFSET	705
6.120.1.79	ETH_PACKETLEN	705
6.120.1.80	ETH_PACKETLEN_MAXFL_OFFSET	705

6.120.1.81	ETH_PACKETLEN_MAXFL_WIDTH	705
6.120.1.82	ETH_PACKETLEN_MINFL_OFFSET	705
6.120.1.83	ETH_PACKETLEN_MINFL_WIDTH	705
6.120.1.84	ETH_RTX_FILE	705
6.120.1.85	ETH_RTX SOCK	705
6.120.1.86	ETH_RTX_VAPI	705
6.120.1.87	ETH_RX_BD_COLLISION_OFFSET	705
6.120.1.88	ETH_RX_BD_CRC_OFFSET	705
6.120.1.89	ETH_RX_BD_DRIBBLE_OFFSET	705
6.120.1.90	ETH_RX_BD_INVALID_OFFSET	705
6.120.1.91	ETH_RX_BD_IRQ_OFFSET	705
6.120.1.92	ETH_RX_BD_LENGTH_OFFSET	705
6.120.1.93	ETH_RX_BD_LENGTH_WIDTH	705
6.120.1.94	ETH_RX_BD_MISS_OFFSET	705
6.120.1.95	ETH_RX_BD_READY_OFFSET	705
6.120.1.96	ETH_RX_BD_TOOBIG_OFFSET	705
6.120.1.97	ETH_RX_BD_TOOSHORT_OFFSET	705
6.120.1.98	ETH_RX_BD_UVERRUN_OFFSET	705
6.120.1.99	ETH_RX_BD_WRAP_OFFSET	705
6.120.1.100	ETH_RXSTATE_IDLE	705
6.120.1.101	ETH_RXSTATE_RECV	705
6.120.1.102	ETH_RXSTATE_WAIT4BD	705
6.120.1.103	ETH_RXSTATE_WRITEFIFO	705
6.120.1.104	ETH_TX_BD_COLLISION_OFFSET	705
6.120.1.105	ETH_TX_BD_CRC_OFFSET	705
6.120.1.106	ETH_TX_BD_DEFER_OFFSET	705
6.120.1.107	ETH_TX_BD_IRQ_OFFSET	705
6.120.1.108	ETH_TX_BD_LAST_OFFSET	705
6.120.1.109	ETH_TX_BD_LENGTH_OFFSET	705
6.120.1.110	ETH_TX_BD_LENGTH_WIDTH	705
6.120.1.111	ETH_TX_BD_NO_CARRIER_OFFSET	705
6.120.1.112	ETH_TX_BD_NUM	705
6.120.1.113	ETH_TX_BD_PAD_OFFSET	705
6.120.1.114	ETH_TX_BD_PAUSE_OFFSET	705
6.120.1.115	ETH_TX_BD_READY_OFFSET	705
6.120.1.116	ETH_TX_BD_RETRANSMIT_OFFSET	705

6.120.1.11	ETH_TX_BD_RETRY_OFFSET	705
6.120.1.11	ETH_TX_BD_RETRY_WIDTH	705
6.120.1.11	ETH_TX_BD_UNDERRUN_OFFSET	705
6.120.1.12	ETH_TX_BD_WRAP_OFFSET	705
6.120.1.12	ETH_TXSTATE_IDLE	705
6.120.1.12	ETH_TXSTATE_READFIFO	705
6.120.1.12	ETH_TXSTATE_TRANSMIT	705
6.120.1.12	ETH_TXSTATE_WAIT4BD	705
6.120.1.12	ETHER_ADDR_LEN	705
6.120.1.12	ETHER_CRC_LEN	705
6.120.1.12	ETHER_HDR_LEN	705
6.120.1.12	ETHER_IS_VALID_LEN	705
6.120.1.12	ETHER_MAX_LEN	705
6.120.1.13	ETHER_MIN_LEN	705
6.120.1.13	ETHER_TYPE_LEN	705
6.120.1.13	ETHERMIN	705
6.120.1.13	ETHERMTU	705
6.120.1.13	ETHERTYPE_ARP	705
6.120.1.13	ETHERTYPE_IP	705
6.120.1.13	ETHERTYPE_NTRAILER	705
6.120.1.13	ETHERTYPE_PUP	705
6.120.1.13	ETHERTYPE_REVARP	705
6.120.1.13	ETHERTYPE_TRAIL	705
6.120.2	Enumeration Type Documentation	705
6.120.2.1	"@45	705
6.120.3	Function Documentation	706
6.120.3.1	eth_baseaddr	706
6.120.3.2	eth_controller_rx_clock	706
6.120.3.3	eth_controller_tx_clock	706
6.120.3.4	eth_dma	707
6.120.3.5	eth_enabled	707
6.120.3.6	eth_irq	707
6.120.3.7	eth_read32	707
6.120.3.8	eth_read_rx_file	707
6.120.3.9	eth_reset	707
6.120.3.10	eth_rtx_type	708

6.120.3.1	leth_rx_channel	708
6.120.3.12	eth_rx_next_packet	708
6.120.3.13	eth_rxfile	708
6.120.3.14	eth_sec_end	710
6.120.3.15	eth_sec_start	711
6.120.3.16	eth_skip_rx_file	711
6.120.3.17	eth_sockif	711
6.120.3.18	eth_status	711
6.120.3.19	eth_tx_channel	711
6.120.3.20	eth_txfile	711
6.120.3.21	leth_vapi_id	712
6.120.3.22	eth_vapi_read	712
6.120.3.23	eth_write32	712
6.120.3.24	eth_write_tx_bd_num	712
6.120.3.25	reg_ethernet_sec	712
6.121	peripheral/eth.h File Reference	714
6.121.1	Function Documentation	714
6.121.1.1	reg_ethernet_sec	714
6.122	peripheral/fb.c File Reference	716
6.122.1	Define Documentation	717
6.122.1.1	CAM_SIZEX	717
6.122.1.2	CAM_SIZEY	717
6.122.1.3	CNV16	717
6.122.1.4	CNV32	717
6.122.1.5	FB_BUFADDR	717
6.122.1.6	FB_CAMBUFADDR	717
6.122.1.7	FB_CAMPOSADDR	717
6.122.1.8	FB_CTRL	717
6.122.1.9	FB_PAL	717
6.122.1.10	FB_SIZEX	717
6.122.1.11	IFB_SIZEY	717
6.122.1.12	FB_WRAP	717
6.122.1.13	REFRESH_DIVIDER	717
6.122.2	Function Documentation	718
6.122.2.1	change_buf_addr	718
6.122.2.2	fb_baseaddr	718

6.122.2.3 fb_dump_image24	718
6.122.2.4 fb_dump_image8	718
6.122.2.5 fb_enabled	718
6.122.2.6 fb_filename	718
6.122.2.7 fb_job	719
6.122.2.8 fb_read32	719
6.122.2.9 fb_refresh_rate	719
6.122.2.10fb_reset	719
6.122.2.11fb_sec_end	720
6.122.2.12fb_sec_start	720
6.122.2.13fb_write32	720
6.122.2.14reg_fb_sec	721
6.123peripheral/fb.h File Reference	722
6.123.1 Function Documentation	722
6.123.1.1 reg_fb_sec	722
6.124peripheral/fields.h File Reference	723
6.124.1 Define Documentation	723
6.124.1.1 ASSIGN_FLAG	723
6.124.1.2 CLEAR_FLAG	724
6.124.1.3 FIELD_MASK	724
6.124.1.4 FIELD_SHIFT	724
6.124.1.5 FLAG_MASK	724
6.124.1.6 FLAG_SHIFT	724
6.124.1.7 GET_FIELD	724
6.124.1.8 SET_FIELD	724
6.124.1.9 SET_FLAG	724
6.124.1.10TEST_FLAG	724
6.125peripheral/generic.c File Reference	725
6.125.1 Function Documentation	726
6.125.1.1 ext_read	726
6.125.1.2 ext_write	726
6.125.1.3 generic_baseaddr	726
6.125.1.4 generic_byte_enabled	726
6.125.1.5 generic_enabled	726
6.125.1.6 generic_hw_enabled	726
6.125.1.7 generic_name	726

6.125.1.8 generic_read_byte . . . . .	726
6.125.1.9 generic_read_hw . . . . .	726
6.125.1.10 generic_read_word . . . . .	727
6.125.1.11 generic_reset . . . . .	727
6.125.1.12 generic_sec_end . . . . .	727
6.125.1.13 generic_sec_start . . . . .	728
6.125.1.14 generic_size . . . . .	728
6.125.1.15 generic_status . . . . .	728
6.125.1.16 generic_word_enabled . . . . .	728
6.125.1.17 generic_write_byte . . . . .	728
6.125.1.18 generic_write_hw . . . . .	728
6.125.1.19 generic_write_word . . . . .	728
6.125.1.20 htonl . . . . .	729
6.125.1.21 htons . . . . .	729
6.125.1.22 ntohl . . . . .	729
6.125.1.23 ntohs . . . . .	729
6.125.1.24 reg_generic_sec . . . . .	729
6.126 peripheral/channels/generic.c File Reference . . . . .	730
6.126.1 Function Documentation . . . . .	730
6.126.1.1 generic_close . . . . .	730
6.126.1.2 generic_free . . . . .	730
6.126.1.3 generic_open . . . . .	730
6.127 peripheral/generic.h File Reference . . . . .	731
6.127.1 Function Documentation . . . . .	731
6.127.1.1 reg_generic_sec . . . . .	731
6.128 peripheral/channels/generic.h File Reference . . . . .	732
6.128.1 Function Documentation . . . . .	732
6.128.1.1 generic_close . . . . .	732
6.128.1.2 generic_free . . . . .	732
6.128.1.3 generic_open . . . . .	732
6.129 peripheral/gpio.c File Reference . . . . .	733
6.129.1 Define Documentation . . . . .	735
6.129.1.1 GPIO_ADDR_SPACE . . . . .	735
6.129.1.2 RGPIO_AUX . . . . .	735
6.129.1.3 RGPIO_CTRL . . . . .	735
6.129.1.4 RGPIO_CTRL_ECLK . . . . .	735

6.129.1.5	RGPIO_CTRL_INTE	735
6.129.1.6	RGPIO_CTRL_INTS	735
6.129.1.7	RGPIO_CTRL_NEC	735
6.129.1.8	RGPIO_IN	735
6.129.1.9	RGPIO_INTE	735
6.129.1.10	RGPIO_INTS	735
6.129.1.11	RGPIO_OE	735
6.129.1.12	RGPIO_OUT	735
6.129.1.13	RGPIO_PTRIG	735
6.129.2	Enumeration Type Documentation	735
6.129.2.1	"@51	735
6.129.3	Function Documentation	736
6.129.3.1	gpio_base_vapi_id	736
6.129.3.2	gpio_baseaddr	736
6.129.3.3	gpio_clock	736
6.129.3.4	gpio_device_clock	736
6.129.3.5	gpio_do_int	737
6.129.3.6	gpio_enabled	737
6.129.3.7	gpio_external_clock	737
6.129.3.8	gpio_irq	738
6.129.3.9	gpio_read32	738
6.129.3.10	gpio_reset	738
6.129.3.11	gpio_sec_end	738
6.129.3.12	gpio_sec_start	739
6.129.3.13	gpio_status	739
6.129.3.14	gpio_vapi_read	739
6.129.3.15	gpio_write32	739
6.129.3.16	reg_gpio_sec	739
6.130	peripheral/gpio.h File Reference	740
6.130.1	Function Documentation	740
6.130.1.1	reg_gpio_sec	740
6.131	peripheral/mc.c File Reference	741
6.131.1	Define Documentation	745
6.131.1.1	MC_ADDR_SPACE	745
6.131.1.2	MC_BA_MASK	745
6.131.1.3	MC_BA_MASK_VALID	745

6.131.1.4 MC_CSC	745
6.131.1.5 MC_CSC_BAS_OFFSET	745
6.131.1.6 MC_CSC_BW_OFFSET	745
6.131.1.7 MC_CSC_BW_WIDTH	745
6.131.1.8 MC_CSC_EN_OFFSET	745
6.131.1.9 MC_CSC_KRO_OFFSET	745
6.131.1.10 MC_CSC_MEMTYPE_ASYNC	745
6.131.1.11 MC_CSC_MEMTYPE_OFFSET	745
6.131.1.12 MC_CSC_MEMTYPE_SDRAM	745
6.131.1.13 MC_CSC_MEMTYPE_SSRAM	745
6.131.1.14 MC_CSC_MEMTYPE_SYNC	745
6.131.1.15 MC_CSC_MEMTYPE_WIDTH	745
6.131.1.16 MC_CSC_MS_OFFSET	745
6.131.1.17 MC_CSC_MS_WIDTH	745
6.131.1.18 MC_CSC_PEN_OFFSET	745
6.131.1.19 MC_CSC_SEL_OFFSET	745
6.131.1.20 MC_CSC_SEL_WIDTH	745
6.131.1.21 MC_CSC_VALID	745
6.131.1.22 MC_CSC_WP_OFFSET	745
6.131.1.23 MC_CSR	745
6.131.1.24 MC_CSR_VALID	745
6.131.1.25 MC_POC	745
6.131.1.26 MC_POC_EN_BW_OFFSET	745
6.131.1.27 MC_POC_EN_BW_WIDTH	745
6.131.1.28 MC_POC_EN_MEMTYPE_OFFSET	745
6.131.1.29 MC_POC_EN_MEMTYPE_WIDTH	745
6.131.1.30 MC_POC_VALID	745
6.131.1.31 MC_TMS	745
6.131.1.32 MC_TMS_ASYNC_TRDV_OFFSET	745
6.131.1.33 MC_TMS_ASYNC_TRDV_WIDTH	745
6.131.1.34 MC_TMS_ASYNC_TRDZ_OFFSET	745
6.131.1.35 MC_TMS_ASYNC_TRDZ_WIDTH	745
6.131.1.36 MC_TMS_ASYNC_TWD_OFFSET	745
6.131.1.37 MC_TMS_ASYNC_TWD_WIDTH	745
6.131.1.38 MC_TMS_ASYNC_TWPW_OFFSET	745
6.131.1.39 MC_TMS_ASYNC_TWPW_WIDTH	745



---

6.131.1.40	MC_TMS_ASYNC_TWWD_OFFSET	745
6.131.1.41	MC_TMS_ASYNC_TWWD_WIDTH	745
6.131.1.42	MC_TMS_ASYNC_VALID	745
6.131.1.43	MC_TMS_SDRAM_BL_OFFSET	745
6.131.1.44	MC_TMS_SDRAM_BL_WIDTH	745
6.131.1.45	MC_TMS_SDRAM_BT_OFFSET	745
6.131.1.46	MC_TMS_SDRAM_CL_OFFSET	745
6.131.1.47	MC_TMS_SDRAM_CL_WIDTH	745
6.131.1.48	MC_TMS_SDRAM_OM_OFFSET	745
6.131.1.49	MC_TMS_SDRAM_OM_WIDTH	745
6.131.1.50	MC_TMS_SDRAM_TRCD_OFFSET	745
6.131.1.51	MC_TMS_SDRAM_TRCD_WIDTH	745
6.131.1.52	MC_TMS_SDRAM_TRFC_OFFSET	745
6.131.1.53	MC_TMS_SDRAM_TRFC_WIDTH	745
6.131.1.54	MC_TMS_SDRAM_TRP_OFFSET	745
6.131.1.55	MC_TMS_SDRAM_TRP_WIDTH	745
6.131.1.56	MC_TMS_SDRAM_TWR_OFFSET	745
6.131.1.57	MC_TMS_SDRAM_TWR_WIDTH	745
6.131.1.58	MC_TMS_SDRAM_VALID	745
6.131.1.59	MC_TMS_SDRAM_WBL_OFFSET	745
6.131.1.60	MC_TMS_SSRAM_VALID	745
6.131.1.61	MC_TMS_SYNC_TRDV_OFFSET	745
6.131.1.62	MC_TMS_SYNC_TRDV_WIDTH	745
6.131.1.63	MC_TMS_SYNC_TRDZ_OFFSET	745
6.131.1.64	MC_TMS_SYNC_TRDZ_WIDTH	745
6.131.1.65	MC_TMS_SYNC_TTO_OFFSET	745
6.131.1.66	MC_TMS_SYNC_TTO_WIDTH	745
6.131.1.67	MC_TMS_SYNC_TWR_OFFSET	745
6.131.1.68	MC_TMS_SYNC_TWR_WIDTH	745
6.131.1.69	MC_TMS_SYNC_VALID	745
6.131.1.70	MC_TMS_VALID	745
6.131.1.71	IN_CE	745
6.131.2	Function Documentation	745
6.131.2.1	mc_baseaddr	745
6.131.2.2	mc_done	745
6.131.2.3	mc_enabled	746

6.131.2.4 mc_index . . . . .	746
6.131.2.5 mc_poc . . . . .	746
6.131.2.6 mc_read_word . . . . .	746
6.131.2.7 mc_reg_mem_area . . . . .	746
6.131.2.8 mc_reset . . . . .	746
6.131.2.9 mc_sec_end . . . . .	747
6.131.2.10 mc_sec_start . . . . .	747
6.131.2.11 mc_status . . . . .	747
6.131.2.12 mc_write_word . . . . .	747
6.131.2.13 reg_mc_sec . . . . .	748
6.131.2.14 set_csc_tms . . . . .	748
6.131.3 Variable Documentation . . . . .	748
6.131.3.1 mc_areas . . . . .	748
6.131.3.2 mcs . . . . .	748
6.132 peripheral/mc.h File Reference . . . . .	749
6.132.1 Function Documentation . . . . .	749
6.132.1.1 mc_done . . . . .	749
6.132.1.2 mc_reg_mem_area . . . . .	750
6.132.1.3 reg_mc_sec . . . . .	750
6.133 peripheral/memory.h File Reference . . . . .	751
6.133.1 Function Documentation . . . . .	752
6.133.1.1 reg_memory_sec . . . . .	752
6.134 peripheral/ps2kbd.c File Reference . . . . .	753
6.134.1 Define Documentation . . . . .	756
6.134.1.1 KBD_BAUD_RATE . . . . .	756
6.134.1.2 KBD_CCMD_DKI . . . . .	756
6.134.1.3 KBD_CCMD_EKI . . . . .	756
6.134.1.4 KBD_CCMD_RCB . . . . .	756
6.134.1.5 KBD_CCMD_ST1 . . . . .	756
6.134.1.6 KBD_CCMD_ST2 . . . . .	756
6.134.1.7 KBD_CCMD_WCB . . . . .	756
6.134.1.8 KBD_CCMDBYTE_EN . . . . .	756
6.134.1.9 KBD_CCMDBYTE_EN2 . . . . .	756
6.134.1.10 KBD_CCMDBYTE_INT . . . . .	756
6.134.1.11 KBD_CCMDBYTE_INT2 . . . . .	756
6.134.1.12 KBD_CCMDBYTE_SYS . . . . .	756

6.134.1.13	KBD_CCMDBYTE_XLAT	756
6.134.1.14	KBD_CTRL	756
6.134.1.15	KBD_DATA	756
6.134.1.16	KBD_KCMD_DK	756
6.134.1.17	KBD_KCMD_ECHO	756
6.134.1.18	KBD_KCMD_EK	756
6.134.1.19	KBD_KCMD_RST	756
6.134.1.20	KBD_KCMD_SRL	756
6.134.1.21	KBD_KRESP_ACK	756
6.134.1.22	KBD_KRESP_ECHO	756
6.134.1.23	KBD_KRESP_RSTOK	756
6.134.1.24	KBD_MAX_BUF	756
6.134.1.25	KBD_SPACE	756
6.134.1.26	KBD_STATUS_A2	756
6.134.1.27	KBD_STATUS_IBF	756
6.134.1.28	KBD_STATUS_INH	756
6.134.1.29	KBD_STATUS_MOBF	756
6.134.1.30	KBD_STATUS_OBF	756
6.134.1.31	KBD_STATUS_PERR	756
6.134.1.32	KBD_STATUS_SYS	756
6.134.1.33	KBD_STATUS_TO	756
6.134.2	Function Documentation	756
6.134.2.1	kbd_baseaddr	756
6.134.2.2	kbd_enabled	756
6.134.2.3	kbd_info	756
6.134.2.4	kbd_irq	756
6.134.2.5	kbd_job	756
6.134.2.6	kbd_put	757
6.134.2.7	kbd_read8	757
6.134.2.8	kbd_reset	757
6.134.2.9	kbd_rxfile	757
6.134.2.10	kbd_sec_end	758
6.134.2.11	kbd_sec_start	758
6.134.2.12	kbd_write8	758
6.134.2.13	reg_kbd_sec	759
6.134.2.14	scan_decode	759

6.134.3 Variable Documentation . . . . .	759
6.134.3.1 code . . . . .	759
6.134.3.2 scan_table . . . . .	759
6.134.3.3 shift . . . . .	759
6.135 peripheral/ps2kbd.h File Reference . . . . .	760
6.135.1 Function Documentation . . . . .	760
6.135.1.1 reg_kbd_sec . . . . .	760
6.136 peripheral/vga.c File Reference . . . . .	761
6.136.1 Define Documentation . . . . .	763
6.136.1.1 VGA_ADDR_SPACE . . . . .	763
6.136.1.2 VGA_CLUTA . . . . .	763
6.136.1.3 VGA_CLUTB . . . . .	763
6.136.1.4 VGA_CTRL . . . . .	763
6.136.1.5 VGA_CTRL_CD . . . . .	763
6.136.1.6 VGA_CTRL_PC . . . . .	763
6.136.1.7 VGA_CTRL_VEN . . . . .	763
6.136.1.8 VGA_HTIM . . . . .	763
6.136.1.9 VGA_HVLEN . . . . .	763
6.136.1.10 VGA_MASK . . . . .	763
6.136.1.11 VGA_STAT . . . . .	763
6.136.1.12 VGA_VBARA . . . . .	763
6.136.1.13 VGA_VBARB . . . . .	763
6.136.1.14 VGA_VTIM . . . . .	763
6.136.2 Function Documentation . . . . .	763
6.136.2.1 reg_vga_sec . . . . .	763
6.136.2.2 vga_baseaddr . . . . .	764
6.136.2.3 vga_dump_image . . . . .	764
6.136.2.4 vga_enabled . . . . .	764
6.136.2.5 vga_filename . . . . .	764
6.136.2.6 vga_irq . . . . .	765
6.136.2.7 vga_job . . . . .	765
6.136.2.8 vga_read32 . . . . .	765
6.136.2.9 vga_refresh_rate . . . . .	765
6.136.2.10 vga_reset . . . . .	765
6.136.2.11 vga_sec_end . . . . .	766
6.136.2.12 vga_sec_start . . . . .	766

6.136.2.13vga_write32 . . . . .	766
6.137peripheral/vga.h File Reference . . . . .	767
6.137.1 Function Documentation . . . . .	767
6.137.1.1 reg_vga_sec . . . . .	767
6.138pic/pic.c File Reference . . . . .	768
6.138.1 Function Documentation . . . . .	769
6.138.1.1 clear_interrupt . . . . .	769
6.138.1.2 pic_edge_trigger . . . . .	769
6.138.1.3 pic_enabled . . . . .	769
6.138.1.4 pic_ints_en . . . . .	769
6.138.1.5 pic_rep_int . . . . .	770
6.138.1.6 pic_reset . . . . .	770
6.138.1.7 reg_pic_sec . . . . .	770
6.138.1.8 report_interrupt . . . . .	771
6.138.2 Variable Documentation . . . . .	771
6.138.2.1 pic_state . . . . .	771
6.138.2.2 pic_state_int . . . . .	771
6.139pic/pic.h File Reference . . . . .	772
6.139.1 Function Documentation . . . . .	772
6.139.1.1 clear_interrupt . . . . .	772
6.139.1.2 pic_ints_en . . . . .	772
6.139.1.3 pic_reset . . . . .	772
6.139.1.4 reg_pic_sec . . . . .	772
6.139.1.5 report_interrupt . . . . .	773
6.140pm/pm.c File Reference . . . . .	774
6.140.1 Function Documentation . . . . .	774
6.140.1.1 pm_enabled . . . . .	774
6.140.1.2 pm_reset . . . . .	774
6.140.1.3 reg_pm_sec . . . . .	775
6.141pm/pm.h File Reference . . . . .	776
6.141.1 Function Documentation . . . . .	776
6.141.1.1 pm_reset . . . . .	776
6.141.1.2 reg_pm_sec . . . . .	776
6.142port/isblank.c File Reference . . . . .	777
6.142.1 Function Documentation . . . . .	777
6.142.1.1 isblank . . . . .	777

---

6.143	port/port.h File Reference	778
6.143.1	Define Documentation	778
6.143.1.1	PRIx16	778
6.143.1.2	PRIx8	778
6.143.2	Function Documentation	778
6.143.2.1	isblank	778
6.143.2.2	strndup	778
6.144	port/strndup.c File Reference	779
6.144.1	Function Documentation	779
6.144.1.1	strndup	779
6.145	profiler.c File Reference	780
6.145.1	Define Documentation	781
6.145.1.1	MAX_STACK	781
6.145.2	Function Documentation	781
6.145.2.1	main_profiler	781
6.145.2.2	prof_acquire	781
6.145.2.3	prof_print	782
6.145.2.4	prof_set	782
6.145.3	Variable Documentation	782
6.145.3.1	cumulative	782
6.145.3.2	fprof	782
6.145.3.3	maxstack	782
6.145.3.4	nfuncalls	782
6.145.3.5	nstack	782
6.145.3.6	ntotcalls	782
6.145.3.7	prof_cycles	782
6.145.3.8	prof_func	782
6.145.3.9	prof_nfuncs	782
6.145.3.10	quiet	782
6.145.3.11	lstack	783
6.146	profiler.h File Reference	784
6.146.1	Define Documentation	784
6.146.1.1	MAX_FUNCS	784
6.146.2	Function Documentation	784
6.146.2.1	main_profiler	784
6.146.2.2	prof_acquire	785

6.146.2.3 prof_set . . . . .	785
6.146.3 Variable Documentation . . . . .	785
6.146.3.1 prof_cycles . . . . .	785
6.146.3.2 prof_func . . . . .	785
6.146.3.3 prof_nfuncs . . . . .	785
6.147 sim-cmd.c File Reference . . . . .	786
6.147.1 Function Documentation . . . . .	788
6.147.1.1 check_insn_exec . . . . .	788
6.147.1.2 handle_sim_command . . . . .	789
6.147.1.3 print_insn_exec . . . . .	790
6.147.1.4 reenter_int . . . . .	790
6.147.1.5 reg_sim_stat . . . . .	791
6.147.1.6 sim_cmd_break . . . . .	791
6.147.1.7 sim_cmd_breaks . . . . .	791
6.147.1.8 sim_cmd_cm . . . . .	791
6.147.1.9 sim_cmd_cuc . . . . .	793
6.147.1.10 sim_cmd_de . . . . .	794
6.147.1.11 sim_cmd_debug . . . . .	794
6.147.1.12 sim_cmd_dh . . . . .	794
6.147.1.13 sim_cmd_dm . . . . .	795
6.147.1.14 sim_cmd_dv . . . . .	795
6.147.1.15 sim_cmd_help . . . . .	795
6.147.1.16 sim_cmd_hist . . . . .	796
6.147.1.17 sim_cmd_info . . . . .	796
6.147.1.18 sim_cmd_mprofile . . . . .	796
6.147.1.19 sim_cmd_pc . . . . .	797
6.147.1.20 sim_cmd_pm . . . . .	797
6.147.1.21 sim_cmd_pr . . . . .	797
6.147.1.22 sim_cmd_profile . . . . .	797
6.147.1.23 sim_cmd_quit . . . . .	798
6.147.1.24 sim_cmd_r . . . . .	798
6.147.1.25 sim_cmd_reset . . . . .	798
6.147.1.26 sim_cmd_run . . . . .	799
6.147.1.27 sim_cmd_set . . . . .	799
6.147.1.28 sim_cmd_setdbch . . . . .	799
6.147.1.29 sim_cmd_stall . . . . .	799

6.147.1.30	sim_cmd_stats	800
6.147.1.31	sim_cmd_trace	800
6.147.1.32	sim_cmd_unstall	800
6.147.1.33	strip_space	800
6.147.2	Variable Documentation	801
6.147.2.1	sim_commands	801
6.147.2.2	sim_stats	801
6.147.2.3	to_insn_num	801
6.148	sim-cmd.h File Reference	802
6.148.1	Function Documentation	802
6.148.1.1	handle_sim_command	802
6.148.1.2	reg_sim_stat	802
6.149	sim-config.c File Reference	803
6.149.1	Function Documentation	805
6.149.1.1	base_include	805
6.149.1.2	init_defconfig	805
6.149.1.3	parse_args	805
6.149.1.4	print_config	806
6.149.1.5	read_script_file	806
6.149.1.6	reg_config_param	808
6.149.1.7	reg_config_sec	808
6.149.1.8	reg_config_secs	808
6.149.1.9	reg_sim_sec	809
6.149.1.10	set_config	810
6.149.1.11	set_config_command	810
6.149.1.12	sim_clkcycle	810
6.149.1.13	sim_debug	810
6.149.1.14	sim_exe_log	811
6.149.1.15	sim_exe_log_end	811
6.149.1.16	sim_exe_log_fn	811
6.149.1.17	sim_exe_log_marker	811
6.149.1.18	sim_exe_log_start	811
6.149.1.19	sim_exe_log_type	811
6.149.1.20	sim_history	811
6.149.1.21	sim_mprof_fn	811
6.149.1.22	sim_mprofile	811



6.149.1.23	sim_prof_fn	811
6.149.1.24	sim_profile	811
6.149.1.25	sim_verbose	811
6.149.1.26	switch_param	811
6.149.2	Variable Documentation	811
6.149.2.1	config	811
6.149.2.2	cur_section	811
6.149.2.3	runtime	811
6.149.2.4	sections	811
6.150	sim-config.h File Reference	812
6.150.1	Define Documentation	813
6.150.1.1	CHECK_INT_TIME	813
6.150.1.2	EXE_LOG_HARDWARE	813
6.150.1.3	EXE_LOG_SIMPLE	813
6.150.1.4	EXE_LOG_SOFTWARE	813
6.150.1.5	MAX_SBUF_LEN	813
6.150.1.6	PRINTF	813
6.150.1.7	STR_SIZE	813
6.150.2	Enumeration Type Documentation	813
6.150.2.1	param_t	813
6.150.3	Function Documentation	814
6.150.3.1	init_defconfig	814
6.150.3.2	parse_args	814
6.150.3.3	print_config	814
6.150.3.4	reg_config_param	816
6.150.3.5	reg_config_sec	816
6.150.3.6	reg_config_secs	816
6.150.3.7	set_config_command	817
6.150.4	Variable Documentation	817
6.150.4.1	config	817
6.150.4.2	cur_section	817
6.150.4.3	do_stats	817
6.150.4.4	runtime	817
6.151	support/dbchs.h File Reference	818
6.152	support/debug.c File Reference	819
6.152.1	Define Documentation	820

6.152.1.1	<code>__ORSIM_NO_DEC_DBCH</code>	820
6.152.1.2	<code>DECLARE_DEBUG_CHANNEL</code>	820
6.152.1.3	<code>DECLARE_DEBUG_CHANNEL</code>	820
6.152.2	Function Documentation	820
6.152.2.1	<code>debug</code>	820
6.152.2.2	<code>orsim_dbcl_set</code>	820
6.152.2.3	<code>orsim_dbcl_set_name</code>	820
6.152.2.4	<code>orsim_dbg_log</code>	820
6.152.2.5	<code>parse_dbchs</code>	820
6.152.3	Variable Documentation	820
6.152.3.1	<code>__orsim_dbchs</code>	820
6.152.3.2	<code>debug_classes</code>	820
6.153	support/debug.h File Reference	821
6.153.1	Define Documentation	822
6.153.1.1	<code>__ORSIM_DBG_USE_FUNC</code>	822
6.153.1.2	<code>__ORSIM_DEBUG_LOG</code>	822
6.153.1.3	<code>__ORSIM_DPRINTF</code>	822
6.153.1.4	<code>__ORSIM_GET_DEBUGGING</code>	822
6.153.1.5	<code>__ORSIM_GET_DEBUGGING_ERR</code>	822
6.153.1.6	<code>__ORSIM_GET_DEBUGGING_FIXME</code>	822
6.153.1.7	<code>__ORSIM_GET_DEBUGGING_TRACE</code>	822
6.153.1.8	<code>__ORSIM_GET_DEBUGGING_WARN</code>	822
6.153.1.9	<code>DECLARE_DEBUG_CHANNEL</code>	822
6.153.1.10	<code>DEFAULT_DEBUG_CHANNEL</code>	822
6.153.1.11	<code>IERR</code>	823
6.153.1.12	<code>IERR_</code>	823
6.153.1.13	<code>IERR_ON</code>	823
6.153.1.14	<code>FIXME</code>	823
6.153.1.15	<code>FIXME_</code>	823
6.153.1.16	<code>FIXME_ON</code>	823
6.153.1.17	<code>TRACE</code>	823
6.153.1.18	<code>TRACE_</code>	823
6.153.1.19	<code>TRACE_ON</code>	823
6.153.1.20	<code>WARN</code>	823
6.153.1.21	<code>IWARN_</code>	823
6.153.1.22	<code>WARN_ON</code>	823

---

6.153.2 Enumeration Type Documentation . . . . .	823
6.153.2.1 __ORSIM_DEBUG_CLASS . . . . .	823
6.153.3 Function Documentation . . . . .	823
6.153.3.1 debug . . . . .	823
6.153.3.2 orsim_dbcl_set_name . . . . .	824
6.153.3.3 orsim_dbg_log . . . . .	824
6.153.3.4 parse_dbchs . . . . .	824
6.154support/dumpverilog.c File Reference . . . . .	825
6.154.1 Define Documentation . . . . .	826
6.154.1.1 DISWIDTH . . . . .	826
6.154.1.2 DW . . . . .	826
6.154.1.3 DWQ . . . . .	826
6.154.1.4 LABELEND_CHAR . . . . .	826
6.154.1.5 OR1K_MEM_VERILOG_FOOTER . . . . .	826
6.154.1.6 OR1K_MEM_VERILOG_HEADER . . . . .	826
6.154.2 Function Documentation . . . . .	827
6.154.2.1 dumphex . . . . .	827
6.154.2.2 dumpverilog . . . . .	827
6.155support/dumpverilog.h File Reference . . . . .	828
6.155.1 Function Documentation . . . . .	829
6.155.1.1 dumphex . . . . .	829
6.155.1.2 dumpverilog . . . . .	829
6.156support/misc.c File Reference . . . . .	830
6.156.1 Function Documentation . . . . .	830
6.156.1.1 is_power2 . . . . .	830
6.156.1.2 log2_int . . . . .	830
6.157support/misc.h File Reference . . . . .	831
6.157.1 Function Documentation . . . . .	831
6.157.1.1 is_power2 . . . . .	831
6.157.1.2 log2_int . . . . .	831
6.158support/profile.c File Reference . . . . .	832
6.158.1 Function Documentation . . . . .	832
6.158.1.1 mprofile . . . . .	832
6.159support/profile.h File Reference . . . . .	833
6.159.1 Define Documentation . . . . .	834
6.159.1.1 MPROF_16 . . . . .	834

6.159.1.2	MPROF_32	834
6.159.1.3	MPROF_8	834
6.159.1.4	MPROF_FETCH	834
6.159.1.5	MPROF_READ	834
6.159.1.6	MPROF_WRITE	834
6.159.2	Function Documentation	834
6.159.2.1	mprofile	834
6.160	support/sched.c File Reference	835
6.160.1	Define Documentation	836
6.160.1.1	SCHED_HEAP_SIZE	836
6.160.1.2	SCHED_TIME_MAX	836
6.160.2	Function Documentation	836
6.160.2.1	DECLARE_DEBUG_CHANNEL	836
6.160.2.2	do_scheduler	836
6.160.2.3	sched_add	836
6.160.2.4	sched_find_remove	836
6.160.2.5	sched_guard	836
6.160.2.6	sched_init	836
6.160.2.7	sched_next_insn	836
6.160.2.8	sched_reset	836
6.160.3	Variable Documentation	836
6.160.3.1	scheduler	836
6.161	support/sched.h File Reference	837
6.161.1	Define Documentation	837
6.161.1.1	SCHED_ADD	837
6.161.1.2	SCHED_FIND_REMOVE	837
6.161.2	Function Documentation	838
6.161.2.1	do_scheduler	838
6.161.2.2	sched_add	838
6.161.2.3	sched_find_remove	838
6.161.2.4	sched_init	838
6.161.2.5	sched_next_insn	838
6.161.2.6	sched_reset	838
6.161.3	Variable Documentation	838
6.161.3.1	scheduler	838
6.162	support/simprintf.c File Reference	839

6.162.1 Define Documentation . . . . .	840
6.162.1.1 FMTLEN . . . . .	840
6.162.1.2 STACK_ARGS . . . . .	840
6.162.2 Function Documentation . . . . .	840
6.162.2.1 simgetstr . . . . .	840
6.162.2.2 simprintf . . . . .	840
6.162.3 Variable Documentation . . . . .	840
6.162.3.1 fmtstr . . . . .	840
6.163support/simprintf.h File Reference . . . . .	841
6.163.1 Function Documentation . . . . .	841
6.163.1.1 simprintf . . . . .	841
6.164tick/tick.c File Reference . . . . .	842
6.164.1 Function Documentation . . . . .	843
6.164.1.1 sched_timer_job . . . . .	843
6.164.1.2 spr_read_ttcrr . . . . .	843
6.164.1.3 spr_write_ttcrr . . . . .	843
6.164.1.4 spr_write_ttmr . . . . .	844
6.164.1.5 tick_one_shot . . . . .	844
6.164.1.6 tick_raise_except . . . . .	844
6.164.1.7 tick_reset . . . . .	844
6.164.1.8 tick_restart . . . . .	845
6.164.2 Variable Documentation . . . . .	845
6.164.2.1 cycles_start . . . . .	845
6.164.2.2 tick_count . . . . .	845
6.165tick/tick.h File Reference . . . . .	846
6.165.1 Function Documentation . . . . .	846
6.165.1.1 spr_read_ttcrr . . . . .	846
6.165.1.2 spr_write_ttcrr . . . . .	846
6.165.1.3 spr_write_ttmr . . . . .	847
6.165.1.4 tick_reset . . . . .	847
6.166toplevel-mprofile.c File Reference . . . . .	848
6.166.1 Function Documentation . . . . .	850
6.166.1.1 main . . . . .	850
6.167toplevel-profile.c File Reference . . . . .	851
6.167.1 Function Documentation . . . . .	853
6.167.1.1 main . . . . .	853

6.168	toplevel-support.c File Reference	854
6.168.1	Function Documentation	855
6.168.1.1	check_int	855
6.168.1.2	ctrl_c	856
6.168.1.3	reg_sim_reset	857
6.168.1.4	sim_done	857
6.168.1.5	sim_init	857
6.168.1.6	sim_reset	858
6.168.2	Variable Documentation	859
6.168.2.1	sim_reset_hooks	859
6.169	toplevel-support.h File Reference	860
6.169.1	Function Documentation	860
6.169.1.1	check_int	860
6.169.1.2	ctrl_c	861
6.169.1.3	reg_sim_reset	861
6.169.1.4	sim_done	862
6.169.1.5	sim_init	862
6.169.1.6	sim_reset	863
6.170	toplevel.c File Reference	865
6.170.1	Function Documentation	865
6.170.1.1	main	865
6.171	vapi/vapi.c File Reference	868
6.171.1	Function Documentation	869
6.171.1.1	add_handler	869
6.171.1.2	find_handler	869
6.171.1.3	get_server_socket	870
6.171.1.4	handler_fits_id	870
6.171.1.5	read_packet	870
6.171.1.6	rebuild_fds	870
6.171.1.7	reg_vapi_sec	870
6.171.1.8	server_request	870
6.171.1.9	vapi_check	871
6.171.1.10	vapi_done	871
6.171.1.11	vapi_enabled	871
6.171.1.12	vapi_hide_device_id	871
6.171.1.13	vapi_init	871

---

6.171.1.14	vapi_install_handler	871
6.171.1.15	vapi_install_multi_handler	872
6.171.1.16	vapi_log_enabled	872
6.171.1.17	vapi_log_fn	872
6.171.1.18	vapi_num_unconnected	872
6.171.1.19	vapi_read_stream	872
6.171.1.20	vapi_request	872
6.171.1.21	vapi_send	873
6.171.1.22	vapi_server_port	873
6.171.1.23	vapi_write_log_file	873
6.171.1.24	vapi_write_stream	873
6.171.1.25	write_packet	873
6.171.2	Variable Documentation	873
6.171.2.1	fds	873
6.171.2.2	nfds	873
6.171.2.3	nhandlers	873
6.171.2.4	server_fd	873
6.171.2.5	serverIP	873
6.171.2.6	tcp_level	873
6.172	vapi/vapi.h File Reference	874
6.172.1	Define Documentation	874
6.172.1.1	VAPI_MAX_DEVID	874
6.172.2	Enumeration Type Documentation	874
6.172.2.1	VAPI_COMMAND	874
6.172.3	Function Documentation	875
6.172.3.1	reg_vapi_sec	875
6.172.3.2	vapi_check	875
6.172.3.3	vapi_done	875
6.172.3.4	vapi_init	876
6.172.3.5	vapi_install_handler	876
6.172.3.6	vapi_install_multi_handler	876
6.172.3.7	vapi_num_unconnected	876
6.172.3.8	vapi_send	876
6.172.3.9	vapi_write_log_file	877





# Chapter 1

## Or1ksim: the OpenRISC 1000 Architectural Simulator

### 1.1 About

This is the entire code base for Or1ksim. It is described in more detail in its user guide, which can be found in the `doc` directory.

Or1ksim uses the ArgTable 2 library to parse its arguments. This documentation excludes that code base.

### 1.2 Installation

See the `INSTALL` file in the main directory for information on building and installing these programs

### 1.3 Documentation

The user guide can be found as a texinfo file in the `doc` subdirectory.

This document may be converted to HTML, PDF, info files or PostScript by the commands "make html", "make pdf", "make info" and "make ps" respectively.

### 1.4 Copying

This file is part of OpenRISC Architectural Simulator.

This program is free software; you can redistribute it and/or modify it under the terms of the GNU General Public License as published by the Free Software Foundation; either version 3 of the License, or (at your option) any later version.

This program is distributed in the hope that it will be useful, but WITHOUT ANY WARRANTY; without even the implied warranty of MERCHANTABILITY or FITNESS FOR A PARTICULAR PURPOSE. See the GNU General Public License for more details.

You should have received a copy of the GNU General Public License along with this program. If not, see <http://www.gnu.org/licenses/>.



## **Chapter 2**

### **Todo List**

**Global [rsp\\_insert\\_matchpoint](#)** This doesn't work with icache/immu yet

**Global [rsp\\_remove\\_matchpoint](#)** This doesn't work with icache/immu yet

**Global [rsp\\_write\\_all\\_regs](#)** There is no error checking at present. Non-hex chars will generate a warning message, but there is no other check that the right amount of data is present. The result is always "OK".

# Chapter 3

## Data Structure Index

### 3.1 Data Structures

Here are the data structures with brief descriptions:

<code>_csm_list</code>	13
<code>_cuc_func</code>	15
<code>_dep_list_t</code>	17
<code>archf</code>	18
<code>ata_device</code>	19
<code>ata_devices</code>	24
<code>ata_host</code>	25
<code>bff</code>	28
<code>BMP_HEADER</code>	29
<code>bpb_entry</code>	30
<code>bpbstat</code>	31
<code>branchstat</code>	32
<code>breakpoint_entry</code>	33
<code>btic_entry</code>	34
<code>bticstat</code>	35
<code>cachestats_entry</code>	36
<code>channel</code>	37
<code>channel_factory</code>	38
<code>channel_ops</code>	39
<code>COFF_AOUTHDR</code>	40
<code>COFF_auxent</code>	41
<code>COFF_filehdr</code>	45
<code>COFF_lineno</code>	46
<code>COFF_reloc</code>	47
<code>COFF_scnhdr</code>	48
<code>COFF_slib</code>	49
<code>COFF_syment</code>	50
<code>config</code>	51
<code>config::pic</code>	57
<code>config_param</code>	58
<code>config_section</code>	59
<code>cpu_state</code>	60
<code>cuc_bb</code>	62

cuc_conv	64
cuc_insn	65
cuc_known_insn	66
cuc_shared_item	67
cuc_timing_table	68
cuc_timings	69
dc_set	70
dev_16450	71
dev_generic	76
dev_memarea	78
dma_channel	80
dma_controller	83
dmmu	85
dmmustats_entry	87
dstats_entry	88
dyn_page	89
dynamic	90
elf32_hdr	91
elf32_note	93
elf32_phdr	94
elf32_rel	95
elf32_rela	96
elf32_shdr	97
elf32_sym	98
Elf64_Dyn	99
elf64_hdr	100
elf64_note	102
elf64_phdr	103
elf64_rel	104
elf64_rela	105
elf64_shdr	106
elf64_sym	107
elf_obj	108
eth_device	110
ether_addr	115
ether_header	116
fb_state	117
fd_channel	119
file_channel	120
fstats_entry	121
func_struct	122
gpio_device	123
hist_exec	125
ic	126
immu	128
immustats_entry	130
INFOHEADER	131
iqueue_entry	132
jtr_chain_message	133
jtr_chain_response	134
jtr_failure_response	135
jtr_read_block_message	136
jtr_read_block_response	137
jtr_read_message	138

---

jtr_read_response	139
jtr_write_block_message	140
jtr_write_block_response	141
jtr_write_message	142
jtr_write_response	143
kbd_state	144
label_entry	145
mc	146
mc_area	148
mem_config	149
mem_ops	151
memory_hash	153
mp_entry	154
mprofentry_struct	155
mstats_entry	156
op_queue	157
param_val	159
raw_stats	160
reloc	161
rsp_buf	162
runtime	163
sched_entry	167
scheduler_struct	168
sim_command	169
sim_reset_hook	170
sim_stat	171
spr_bit_def	172
spr_def	173
sstats_entry	174
stack_struct	175
tcp_channel	176
tty_channel	177
vapi_handler	178
vga_state	179
xterm_channel	181





# Chapter 4

## File Index

### 4.1 File List

Here is a list of all files with brief descriptions:

<a href="#">cpu-config.c</a>	206
<a href="#">cpu-config.h</a>	210
<a href="#">libtoplevel.c</a>	564
<a href="#">mainpage</a>	571
<a href="#">mprofiler.c</a>	589
<a href="#">mprofiler.h</a>	593
<a href="#">or1ksim.h</a>	594
<a href="#">profiler.c</a>	780
<a href="#">profiler.h</a>	784
<a href="#">sim-cmd.c</a>	786
<a href="#">sim-cmd.h</a>	802
<a href="#">sim-config.c</a>	803
<a href="#">sim-config.h</a>	812
<a href="#">toplevel-mprofile.c</a>	848
<a href="#">toplevel-profile.c</a>	851
<a href="#">toplevel-support.c</a>	854
<a href="#">toplevel-support.h</a>	860
<a href="#">toplevel.c</a>	865
<a href="#">bpb/branch-predict.c</a>	183
<a href="#">bpb/branch-predict.h</a>	188
<a href="#">cache/dcache-model.c</a>	190
<a href="#">cache/dcache-model.h</a>	195
<a href="#">cache/icache-model.c</a>	198
<a href="#">cache/icache-model.h</a>	203
<a href="#">cpu/common/abstract.c</a>	211
<a href="#">cpu/common/abstract.h</a>	229
<a href="#">cpu/common/coff.h</a>	244
<a href="#">cpu/common/elf.h</a>	251
<a href="#">cpu/common/execute.h</a>	261
<a href="#">cpu/common/labels.c</a>	268
<a href="#">cpu/common/labels.h</a>	270
<a href="#">cpu/common/parse.c</a>	272
<a href="#">cpu/common/parse.h</a>	278

<a href="#">cpu/common/stats.c</a>	280
<a href="#">cpu/common/stats.h</a>	284
<a href="#">cpu/common/trace.c</a>	286
<a href="#">cpu/common/trace.h</a>	288
<a href="#">cpu/or1k/arch.h</a>	290
<a href="#">cpu/or1k/except.c</a>	292
<a href="#">cpu/or1k/except.h</a>	294
<a href="#">cpu/or1k/spr-defs.h</a>	298
<a href="#">cpu/or1k/spr-dump.c</a>	308
<a href="#">cpu/or1k/spr-dump.h</a>	320
<a href="#">cpu/or1k/sprs.c</a>	321
<a href="#">cpu/or1k/sprs.h</a>	323
<a href="#">cpu/or32/common-i386.h</a>	325
<a href="#">cpu/or32/def-op-t.h</a>	326
<a href="#">cpu/or32/dyn-rec.c</a>	328
<a href="#">cpu/or32/dyn-rec.h</a>	352
<a href="#">cpu/or32/dyn32-defs.h</a>	357
<a href="#">cpu/or32/dyngen-elf.c</a>	358
<a href="#">cpu/or32/dyngen-i386.c</a>	360
<a href="#">cpu/or32/dyngen.c</a>	362
<a href="#">cpu/or32/dyngen.h</a>	365
<a href="#">cpu/or32/execute.c</a>	366
<a href="#">cpu/or32/generate.c</a>	377
<a href="#">cpu/or32/i386-regs.h</a>	380
<a href="#">cpu/or32/insnset.c</a>	381
<a href="#">cpu/or32/op-1t-op.h</a>	393
<a href="#">cpu/or32/op-1t.h</a>	394
<a href="#">cpu/or32/op-2t-op.h</a>	395
<a href="#">cpu/or32/op-2t.h</a>	396
<a href="#">cpu/or32/op-3t-op.h</a>	397
<a href="#">cpu/or32/op-3t.h</a>	398
<a href="#">cpu/or32/op-arith-op.h</a>	399
<a href="#">cpu/or32/op-comp-op.h</a>	400
<a href="#">cpu/or32/op-extend-op.h</a>	401
<a href="#">cpu/or32/op-ff1-op.h</a>	402
<a href="#">cpu/or32/op-i386.h</a>	403
<a href="#">cpu/or32/op-lwhb-op.h</a>	404
<a href="#">cpu/or32/op-mac-op.h</a>	405
<a href="#">cpu/or32/op-mftspr-op.h</a>	406
<a href="#">cpu/or32/op-support.c</a>	407
<a href="#">cpu/or32/op-support.h</a>	409
<a href="#">cpu/or32/op-swhb-op.h</a>	411
<a href="#">cpu/or32/op-t-reg-mov-op.h</a>	412
<a href="#">cpu/or32/op.c</a>	416
<a href="#">cpu/or32/or32.c</a>	430
<a href="#">cpu/or32/rec-i386.h</a>	437
<a href="#">cpu/or32/sched-i386.h</a>	438
<a href="#">cpu/or32/simpl32-defs.h</a>	439
<a href="#">cuc/adv.c</a>	440
<a href="#">cuc/bb.c</a>	442
<a href="#">cuc/cuc.c</a>	448
<a href="#">cuc/cuc.h</a>	464
<a href="#">cuc/insn.c</a>	482
<a href="#">cuc/insn.h</a>	488

<a href="#">cuc/load.c</a>	494
<a href="#">cuc/memory.c</a>	499
<a href="#">cuc/timings.c</a>	507
<a href="#">cuc/verilog.c</a>	510
<a href="#">cuc/verilog.h</a>	513
<a href="#">debug/debug-unit.c</a>	514
<a href="#">debug/debug-unit.h</a>	524
<a href="#">debug/gdb.h</a>	529
<a href="#">debug/gdbcomm.c</a>	531
<a href="#">debug/gdbcomm.h</a>	535
<a href="#">debug/rsp-server.c</a>	537
<a href="#">debug/rsp-server.h</a>	561
<a href="#">mmu/dmmu.c</a>	572
<a href="#">mmu/dmmu.h</a>	578
<a href="#">mmu/immu.c</a>	581
<a href="#">mmu/immu.h</a>	586
<a href="#">peripheral/16450.c</a>	598
<a href="#">peripheral/16450.h</a>	620
<a href="#">peripheral/atacmd.h</a>	624
<a href="#">peripheral/atadevice-cmdi.c</a>	628
<a href="#">peripheral/atadevice-cmdi.h</a>	633
<a href="#">peripheral/atadevice.c</a>	638
<a href="#">peripheral/atadevice.h</a>	642
<a href="#">peripheral/atahost.c</a>	647
<a href="#">peripheral/atahost.h</a>	657
<a href="#">peripheral/crc32.c</a>	681
<a href="#">peripheral/crc32.h</a>	682
<a href="#">peripheral/dma-defs.h</a>	683
<a href="#">peripheral/dma.c</a>	690
<a href="#">peripheral/dma.h</a>	697
<a href="#">peripheral/eth.c</a>	699
<a href="#">peripheral/eth.h</a>	714
<a href="#">peripheral/fb.c</a>	716
<a href="#">peripheral/fb.h</a>	722
<a href="#">peripheral/fields.h</a>	723
<a href="#">peripheral/generic.c</a>	725
<a href="#">peripheral/generic.h</a>	731
<a href="#">peripheral/gpio.c</a>	733
<a href="#">peripheral/gpio.h</a>	740
<a href="#">peripheral/mc.c</a>	741
<a href="#">peripheral/mc.h</a>	749
<a href="#">peripheral/memory.c</a>	502
<a href="#">peripheral/memory.h</a>	751
<a href="#">peripheral/ps2kbd.c</a>	753
<a href="#">peripheral/ps2kbd.h</a>	760
<a href="#">peripheral/vga.c</a>	761
<a href="#">peripheral/vga.h</a>	767
<a href="#">peripheral/channels/channel.c</a>	663
<a href="#">peripheral/channels/channel.h</a>	665
<a href="#">peripheral/channels/fd.c</a>	666
<a href="#">peripheral/channels/fd.h</a>	668
<a href="#">peripheral/channels/file.c</a>	669
<a href="#">peripheral/channels/file.h</a>	671
<a href="#">peripheral/channels/generic.c</a>	730

peripheral/channels/ <a href="#">generic.h</a>	732
peripheral/channels/ <a href="#">tcp.c</a>	672
peripheral/channels/ <a href="#">tcp.h</a>	674
peripheral/channels/ <a href="#">tty.c</a>	675
peripheral/channels/ <a href="#">tty.h</a>	677
peripheral/channels/ <a href="#">xterm.c</a>	678
peripheral/channels/ <a href="#">xterm.h</a>	680
pic/ <a href="#">pic.c</a>	768
pic/ <a href="#">pic.h</a>	772
pm/ <a href="#">pm.c</a>	774
pm/ <a href="#">pm.h</a>	776
port/ <a href="#">isblank.c</a>	777
port/ <a href="#">port.h</a>	778
port/ <a href="#">strndup.c</a>	779
support/ <a href="#">dbchs.h</a>	818
support/ <a href="#">debug.c</a>	819
support/ <a href="#">debug.h</a>	821
support/ <a href="#">dumpverilog.c</a>	825
support/ <a href="#">dumpverilog.h</a>	828
support/ <a href="#">misc.c</a>	830
support/ <a href="#">misc.h</a>	831
support/ <a href="#">profile.c</a>	832
support/ <a href="#">profile.h</a>	833
support/ <a href="#">sched.c</a>	835
support/ <a href="#">sched.h</a>	837
support/ <a href="#">simprintf.c</a>	839
support/ <a href="#">simprintf.h</a>	841
tick/ <a href="#">tick.c</a>	842
tick/ <a href="#">tick.h</a>	846
vapi/ <a href="#">vapi.c</a>	868
vapi/ <a href="#">vapi.h</a>	874

# Chapter 5

## Data Structure Documentation

### 5.1 `_csm_list` Struct Reference

```
#include <cuc.h>
```

Collaboration diagram for `_csm_list`:



#### Data Fields

- `int ref`
- `int cnt`
- `int cmovs`
- `double size`
- `double osize`
- `int cmatch`
- `int dead`
- `int ninsn`
- `struct _csm_list * from`
- `struct _csm_list * next`

## 5.1.1 Field Documentation

5.1.1.1 `int _csm_list::cmatch`

5.1.1.2 `int _csm_list::cmovs`

5.1.1.3 `int _csm_list::cnt`

5.1.1.4 `int _csm_list::dead`

5.1.1.5 `struct _csm_list* _csm_list::from` [read]

5.1.1.6 `struct _csm_list* _csm_list::next` [read]

5.1.1.7 `int _csm_list::ninsn`

5.1.1.8 `double _csm_list::osize`

5.1.1.9 `int _csm_list::ref`

5.1.1.10 `double _csm_list::size`

The documentation for this struct was generated from the following file:

- [cuc/cuc.h](#)

## 5.2 `_cuc_func` Struct Reference

```
#include <cuc.h>
```

Collaboration diagram for `_cuc_func`:

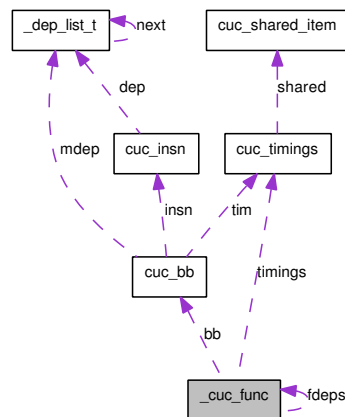

### Data Fields

- int `num_bb`
- `cuc_bb` `bb` [MAX\_BB]
- int `saved_regs` [MAX\_REGS]
- int `lur` [MAX\_REGS]
- int `used_regs` [MAX\_REGS]
- int `nmsched`
- int `msched` [MAX\_INSNS]
- int `mtype` [MAX\_INSNS]
- int `num_init_bb`
- int \* `init_bb_reloc`
- int `orig_time`
- int `num_runs`
- `cuc_timings` `timings`
- unsigned long `start_addr`
- unsigned long `end_addr`
- int `memory_order`
- int `nfdeps`
- struct `_cuc_func` \*\* `fdeps`
- int `tmp`

## 5.2.1 Field Documentation

- 5.2.1.1 `cuc_bb _cuc_func::bb[MAX_BB]`
- 5.2.1.2 `unsigned long _cuc_func::end_addr`
- 5.2.1.3 `struct _cuc_func** _cuc_func::fdeps` [read]
- 5.2.1.4 `int* _cuc_func::init_bb_reloc`
- 5.2.1.5 `int _cuc_func::lur[MAX_REGS]`
- 5.2.1.6 `int _cuc_func::memory_order`
- 5.2.1.7 `int _cuc_func::msched[MAX_INSNS]`
- 5.2.1.8 `int _cuc_func::mtype[MAX_INSNS]`
- 5.2.1.9 `int _cuc_func::nfdeps`
- 5.2.1.10 `int _cuc_func::nmsched`
- 5.2.1.11 `int _cuc_func::num_bb`
- 5.2.1.12 `int _cuc_func::num_init_bb`
- 5.2.1.13 `int _cuc_func::num_runs`
- 5.2.1.14 `int _cuc_func::orig_time`
- 5.2.1.15 `int _cuc_func::saved_regs[MAX_REGS]`
- 5.2.1.16 `unsigned long _cuc_func::start_addr`
- 5.2.1.17 `cuc_timings _cuc_func::timings`
- 5.2.1.18 `int _cuc_func::tmp`
- 5.2.1.19 `int _cuc_func::used_regs[MAX_REGS]`

The documentation for this struct was generated from the following file:

- [cuc/cuc.h](#)



## 5.3 `_dep_list_t` Struct Reference

```
#include <cuc.h>
```

Collaboration diagram for `_dep_list_t`:

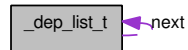

### Data Fields

- unsigned long [ref](#)
- struct `_dep_list_t` \* [next](#)

### 5.3.1 Field Documentation

**5.3.1.1** `struct _dep_list_t* _dep_list_t::next` [read]

**5.3.1.2** `unsigned long _dep_list_t::ref`

The documentation for this struct was generated from the following file:

- [cuc/cuc.h](#)

## 5.4 archf Struct Reference

```
#include <dyngen.h>
```

### Data Fields

- unsigned int(\* [get\\_real\\_func\\_len](#))(void \*func, unsigned int len, char \*name)
- void(\* [gen\\_reloc](#))(FILE \*f, struct [reloc](#) \*reloc, unsigned int param)
- void(\* [gen\\_func\\_reloc](#))(FILE \*f, struct [reloc](#) \*reloc)

### 5.4.1 Field Documentation

**5.4.1.1 void(\* archf::gen\_func\_reloc)(FILE \*f, struct reloc \*reloc)**

**5.4.1.2 void(\* archf::gen\_reloc)(FILE \*f, struct reloc \*reloc, unsigned int param)**

**5.4.1.3 unsigned int(\* archf::get\_real\_func\_len)(void \*func, unsigned int len, char \*name)**

The documentation for this struct was generated from the following file:

- [cpu/or32/dyngen.h](#)

## 5.5 ata\_device Struct Reference

```
#include <atadevice.h>
```

### Data Fields

- struct {
  - void \* `host`
  - int `dev`
  - int `pio_mode`
  - int `dma_mode`
  - uint16\_t `dbuf` [4096]
  - uint16\_t \* `dbuf_ptr`
  - uint16\_t `dbuf_cnt`
  - int `state`
  - unsigned int `heads_per_cylinder`
  - unsigned int `sectors_per_track`
  - uint32\_t `lba`
  - int `nr_sect`
  - void(\* `end_t_func`)(struct `ata_device` \*)
- `internals`
- struct {
  - uint8\_t `command`
  - uint8\_t `cylinder_low`
  - uint8\_t `cylinder_high`
  - uint8\_t `device_control`
  - uint8\_t `device_head`
  - uint8\_t `error`
  - uint8\_t `features`
  - uint8\_t `sector_count`
  - uint8\_t `sector_number`
  - uint8\_t `status`
  - uint16\_t `dataport_i`
- `regs`
- struct {
  - int `iordy`
  - int `intrq`
  - int `dmarq`
  - int `pdiagi`
  - int `pdiago`
  - int `daspi`
  - int `daspo`
- `sigs`
- struct {
  - char \* `file`
  - FILE \* `stream`
  - int `type`
  - uint32\_t `size`
  - uint32\_t `size_sect`

```
int packet
unsigned int heads
unsigned int sectors
char * firmware
unsigned int mwdma
unsigned int pio
} conf
```



## 5.5.1 Field Documentation

5.5.1.1 `uint8_t ata_device::command`

5.5.1.2 `struct { ... } ata_device::conf`

5.5.1.3 `uint8_t ata_device::cylinder_high`

5.5.1.4 `uint8_t ata_device::cylinder_low`

5.5.1.5 `int ata_device::daspi`

5.5.1.6 `int ata_device::daspo`

5.5.1.7 `uint16_t ata_device::dataport_i`

5.5.1.8 `uint16_t ata_device::dbuf[4096]`

5.5.1.9 `uint16_t ata_device::dbuf_cnt`

5.5.1.10 `uint16_t* ata_device::dbuf_ptr`

5.5.1.11 `int ata_device::dev`

5.5.1.12 `uint8_t ata_device::device_control`

5.5.1.13 `uint8_t ata_device::device_head`

5.5.1.14 `int ata_device::dma_mode`

5.5.1.15 `int ata_device::dmarq`

5.5.1.16 `void(* ata_device::end_t_func)(struct ata_device *)`

5.5.1.17 `uint8_t ata_device::error`

5.5.1.18 `uint8_t ata_device::features`

5.5.1.19 `char* ata_device::file`

5.5.1.20 `char* ata_device::firmware`

5.5.1.21 `unsigned int ata_device::heads`

5.5.1.22 `unsigned int ata_device::heads_per_cylinder`

5.5.1.23 `void* ata_device::host`

5.5.1.24 `struct { ... } ata_device::internals`

5.5.1.25 `int ata_device::intrq`

5.5.1.26 `int ata_device::iordy`

5.5.1.27 `uint32_t ata_device::iba`

5.5.1.28 `unsigned int ata_device::mwdma`

5.5.1.29 `int ata_device::nr_sect`

5.5.1.30 `int ata_device::packet`

- [peripheral/atadevice.h](#)

## 5.6 ata\_devices Struct Reference

```
#include <atadevice.h>
```

Collaboration diagram for ata\_devices:

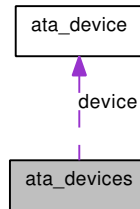

### Data Fields

- struct [ata\\_device](#) `device` [2]

### 5.6.1 Field Documentation

**5.6.1.1** struct `ata_device` `ata_devices::device[2]` [read]

The documentation for this struct was generated from the following file:

- [peripheral/atadevice.h](#)



## 5.7 ata\_host Struct Reference

```
#include <atahost.h>
```

Collaboration diagram for ata\_host:

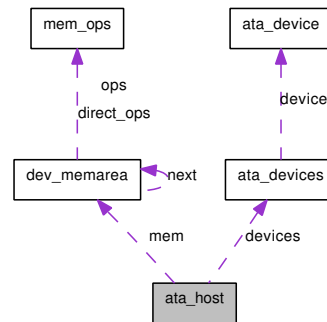

### Data Fields

- int [enabled](#)
- [oraddr\\_t](#) baseaddr
- struct [dev\\_memarea](#) \* mem
- int irq
- int dev\_id
- int rev
- int dev\_sel
- [uint8\\_t](#) pio\_mode0\_t1
- [uint8\\_t](#) pio\_mode0\_t2
- [uint8\\_t](#) pio\_mode0\_t4
- [uint8\\_t](#) pio\_mode0\_teoc
- [uint8\\_t](#) dma\_mode0\_tm
- [uint8\\_t](#) dma\_mode0\_td
- [uint8\\_t](#) dma\_mode0\_teoc
- struct {
  - [uint32\\_t](#) ctrl
  - [uint32\\_t](#) stat
  - [uint32\\_t](#) pctr
  - [uint32\\_t](#) pftr0
  - [uint32\\_t](#) pftr1
  - [uint32\\_t](#) dtr0
  - [uint32\\_t](#) dtr1
  - [uint32\\_t](#) txb
  - [uint32\\_t](#) rxb
 } [regs](#)
- struct [ata\\_devices](#) devices

## 5.7.1 Field Documentation

- 5.7.1.1 `oraddr_t ata_host::baseaddr`
- 5.7.1.2 `uint32_t ata_host::ctrl`
- 5.7.1.3 `int ata_host::dev_id`
- 5.7.1.4 `int ata_host::dev_sel`
- 5.7.1.5 `struct ata_devices ata_host::devices` [read]
- 5.7.1.6 `uint8_t ata_host::dma_mode0_td`
- 5.7.1.7 `uint8_t ata_host::dma_mode0_tec`
- 5.7.1.8 `uint8_t ata_host::dma_mode0_tm`
- 5.7.1.9 `uint32_t ata_host::dtr0`
- 5.7.1.10 `uint32_t ata_host::dtr1`
- 5.7.1.11 `int ata_host::enabled`
- 5.7.1.12 `int ata_host::irq`
- 5.7.1.13 `struct dev_memarea* ata_host::mem` [read]
- 5.7.1.14 `uint32_t ata_host::pctr`
- 5.7.1.15 `uint32_t ata_host::pftr0`
- 5.7.1.16 `uint32_t ata_host::pftr1`
- 5.7.1.17 `uint8_t ata_host::pio_mode0_t1`
- 5.7.1.18 `uint8_t ata_host::pio_mode0_t2`
- 5.7.1.19 `uint8_t ata_host::pio_mode0_t4`
- 5.7.1.20 `uint8_t ata_host::pio_mode0_tec`
- 5.7.1.21 `struct { ... } ata_host::regs`
- 5.7.1.22 `int ata_host::rev`
- 5.7.1.23 `uint32_t ata_host::rxb`
- 5.7.1.24 `uint32_t ata_host::stat`
- 5.7.1.25 `uint32_t ata_host::txb`

The documentation for this struct was generated from the following file:

- [peripheral/atahost.h](#)

## 5.8 bff Struct Reference

```
#include <dyngen.h>
```

### Data Fields

- void **\***(**\*** [open\\_obj](#) )(const char **\***object)
- void(**\*** [close\\_obj](#) )(void **\***)
- char **\***(**\*** [get\\_func\\_name](#) )(void **\***, unsigned int [func](#))
- void **\***(**\*** [get\\_func\\_start](#) )(void **\***, unsigned int [func](#))
- unsigned int(**\*** [get\\_func\\_len](#) )(void **\***, unsigned int [func](#))
- int(**\*** [get\\_func\\_reloc](#) )(void **\***, unsigned int [func](#), unsigned int [relocn](#), struct [reloc](#) **\***reloc)

### 5.8.1 Field Documentation

**5.8.1.1** void(**\*** [bff::close\\_obj](#))(void **\***)

**5.8.1.2** unsigned int(**\*** [bff::get\\_func\\_len](#))(void **\***, unsigned int [func](#))

**5.8.1.3** char(**\*** [bff::get\\_func\\_name](#))(void **\***, unsigned int [func](#))

**5.8.1.4** int(**\*** [bff::get\\_func\\_reloc](#))(void **\***, unsigned int [func](#), unsigned int [relocn](#), struct [reloc](#) **\***reloc)

**5.8.1.5** void(**\*** [bff::get\\_func\\_start](#))(void **\***, unsigned int [func](#))

**5.8.1.6** void(**\*** [bff::open\\_obj](#))(const char **\***object)

The documentation for this struct was generated from the following file:

- [cpu/or32/dyngen.h](#)

## 5.9 BMP\_HEADER Struct Reference

### Data Fields

- unsigned short int [type](#)
- unsigned int [size](#)
- unsigned short int [reserved1](#)
- unsigned short int [reserved2](#)
- unsigned int [offset](#)

### 5.9.1 Field Documentation

**5.9.1.1** unsigned int `BMP_HEADER::offset`

**5.9.1.2** unsigned short int `BMP_HEADER::reserved1`

**5.9.1.3** unsigned short int `BMP_HEADER::reserved2`

**5.9.1.4** unsigned int `BMP_HEADER::size`

**5.9.1.5** unsigned short int `BMP_HEADER::type`

The documentation for this struct was generated from the following file:

- [peripheral/vga.c](#)

## 5.10 bpb\_entry Struct Reference

### Data Fields

- struct {
  - [oraddr\\_t](#) `addr`
  - int `taken`
  - int `lru`
  - } `way` [`BPB_WAYS`]

### 5.10.1 Field Documentation

#### 5.10.1.1 `oraddr_t bpb_entry::addr`

#### 5.10.1.2 `int bpb_entry::lru`

#### 5.10.1.3 `int bpb_entry::taken`

#### 5.10.1.4 `struct { ... } bpb_entry::way[BPB_WAYS]`

The documentation for this struct was generated from the following file:

- [bpb/branch-predict.c](#)

## 5.11 bpbstat Struct Reference

```
#include <stats.h>
```

### Data Fields

- int [hit](#)
- int [miss](#)
- int [correct](#)
- int [incorrect](#)

### 5.11.1 Field Documentation

**5.11.1.1** int `bpbstat::correct`

**5.11.1.2** int `bpbstat::hit`

**5.11.1.3** int `bpbstat::incorrect`

**5.11.1.4** int `bpbstat::miss`

The documentation for this struct was generated from the following file:

- `cpu/common/stats.h`

## 5.12 branchstat Struct Reference

### Data Fields

- int [taken](#)
- int [nottaken](#)
- int [forward](#)
- int [backward](#)

### 5.12.1 Field Documentation

#### 5.12.1.1 int branchstat::backward

#### 5.12.1.2 int branchstat::forward

#### 5.12.1.3 int branchstat::nottaken

#### 5.12.1.4 int branchstat::taken

The documentation for this struct was generated from the following file:

- [cpu/common/stats.c](#)



## 5.13 breakpoint\_entry Struct Reference

```
#include <labels.h>
```

Collaboration diagram for breakpoint\_entry:

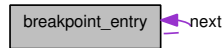

### Data Fields

- [oraddr\\_t](#) addr
- struct [breakpoint\\_entry](#) \* next

### 5.13.1 Detailed Description

Structure representing a breakpoint

### 5.13.2 Field Documentation

**5.13.2.1** [oraddr\\_t](#) breakpoint\_entry::addr

**5.13.2.2** [struct breakpoint\\_entry\\*](#) breakpoint\_entry::next [read]

The documentation for this struct was generated from the following file:

- [cpu/common/labels.h](#)

## 5.14 btic\_entry Struct Reference

### Data Fields

- struct {
  - [oraddr\\_t](#) `addr`
  - int `lru`
  - char \* `insn`
  - } `way` [`BTIC_WAYS`]

### 5.14.1 Field Documentation

5.14.1.1 `oraddr_t btic_entry::addr`

5.14.1.2 `char* btic_entry::insn`

5.14.1.3 `int btic_entry::lru`

5.14.1.4 `struct { ... } btic_entry::way[BTIC_WAYS]`

The documentation for this struct was generated from the following file:

- [bpb/branch-predict.c](#)

## 5.15 bticstat Struct Reference

```
#include <stats.h>
```

### Data Fields

- int [hit](#)
- int [miss](#)

### 5.15.1 Field Documentation

#### 5.15.1.1 int bticstat::hit

#### 5.15.1.2 int bticstat::miss

The documentation for this struct was generated from the following file:

- [cpu/common/stats.h](#)

## 5.16 cachestats\_entry Struct Reference

```
#include <stats.h>
```

### Data Fields

- int [readhit](#)
- int [readmiss](#)
- int [writehit](#)
- int [writemiss](#)

### 5.16.1 Field Documentation

**5.16.1.1** int cachestats\_entry::readhit

**5.16.1.2** int cachestats\_entry::readmiss

**5.16.1.3** int cachestats\_entry::writehit

**5.16.1.4** int cachestats\_entry::writemiss

The documentation for this struct was generated from the following file:

- [cpu/common/stats.h](#)

## 5.17 channel Struct Reference

```
#include <channel.h>
```

Collaboration diagram for channel:

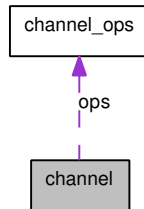

### Data Fields

- struct [channel\\_ops](#) \* ops
- void \* data

#### 5.17.1 Detailed Description

A data structure representing a [channel](#). Its operations and data

#### 5.17.2 Field Documentation

##### 5.17.2.1 void\* channel::data

##### 5.17.2.2 struct channel\_ops\* channel::ops [read]

The documentation for this struct was generated from the following file:

- [peripheral/channels/channel.h](#)

## 5.18 channel\_factory Struct Reference

Collaboration diagram for channel\_factory:

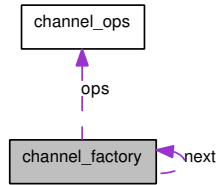

### Data Fields

- `const char * name`
- `struct channel_ops * ops`
- `struct channel_factory * next`

### 5.18.1 Field Documentation

**5.18.1.1** `const char* channel_factory::name`

**5.18.1.2** `struct channel_factory* channel_factory::next` [read]

**5.18.1.3** `struct channel_ops* channel_factory::ops` [read]

The documentation for this struct was generated from the following file:

- `peripheral/channels/channel.c`

## 5.19 channel\_ops Struct Reference

```
#include <channel.h>
```

### Data Fields

- void **\***(**\*** [init](#))(const char **\***)
- int(**\*** [open](#))(void **\***)
- void(**\*** [close](#))(void **\***)
- int(**\*** [read](#))(void **\***, char **\***, int)
- int(**\*** [write](#))(void **\***, const char **\***, int)
- void(**\*** [free](#))(void **\***)
- int(**\*** [isok](#))(void **\***)
- char **\***(**\*** [status](#))(void **\***)

### 5.19.1 Detailed Description

A data structure representing all the functions required on a [channel](#)

### 5.19.2 Field Documentation

**5.19.2.1** void(**\*** [channel\\_ops::close](#))(void **\***)

**5.19.2.2** void(**\*** [channel\\_ops::free](#))(void **\***)

**5.19.2.3** void(**\*** [channel\\_ops::init](#))(const char **\***)

**5.19.2.4** int(**\*** [channel\\_ops::isok](#))(void **\***)

**5.19.2.5** int(**\*** [channel\\_ops::open](#))(void **\***)

**5.19.2.6** int(**\*** [channel\\_ops::read](#))(void **\***, char **\***, int)

**5.19.2.7** char(**\*** [channel\\_ops::status](#))(void **\***)

**5.19.2.8** int(**\*** [channel\\_ops::write](#))(void **\***, const char **\***, int)

The documentation for this struct was generated from the following file:

- peripheral/channels/[channel.h](#)

## 5.20 COFF\_AOUTHDR Struct Reference

```
#include <coff.h>
```

### Data Fields

- char [magic](#) [2]
- char [vstamp](#) [2]
- char [tsize](#) [4]
- char [dsize](#) [4]
- char [bsize](#) [4]
- char [entry](#) [4]
- char [text\\_start](#) [4]
- char [data\\_start](#) [4]

### 5.20.1 Field Documentation

**5.20.1.1 char COFF\_AOUTHDR::bsize[4]**

**5.20.1.2 char COFF\_AOUTHDR::data\_start[4]**

**5.20.1.3 char COFF\_AOUTHDR::dsize[4]**

**5.20.1.4 char COFF\_AOUTHDR::entry[4]**

**5.20.1.5 char COFF\_AOUTHDR::magic[2]**

**5.20.1.6 char COFF\_AOUTHDR::text\_start[4]**

**5.20.1.7 char COFF\_AOUTHDR::tsize[4]**

**5.20.1.8 char COFF\_AOUTHDR::vstamp[2]**

The documentation for this struct was generated from the following file:

- [cpu/common/coff.h](#)



## 5.21 COFF\_auxent Union Reference

```
#include <coff.h>
```

### Data Fields

- struct {
    - char [x\\_tagndx](#) [4]
    - union {
      - struct {
        - char [x\\_inno](#) [2]
        - char [x\\_size](#) [2]
      - } [x\\_insz](#)
      - char [x\\_fsize](#) [4]
    - } [x\\_misc](#)
    - union {
      - struct {
        - char [x\\_innoptr](#) [4]
        - char [x\\_endndx](#) [4]
      - } [x\\_fcn](#)
      - struct {
        - char [x\\_dimen](#) [E\_DIMNUM][2]
      - } [x\\_ary](#)
    - } [x\\_fcary](#)
    - char [x\\_tvndx](#) [2]
  - } [x\\_sym](#)
- union {
  - char [x\\_fname](#) [E\_FILNMLEN]
  - struct {
    - char [x\\_zeroes](#) [4]
    - char [x\\_offset](#) [4]
  - } [x\\_n](#)
- } [x\\_file](#)
- struct {
  - char [x\\_scnlen](#) [4]
  - char [x\\_nreloc](#) [2]
  - char [x\\_nlinno](#) [2]
- } [x\\_scn](#)
- struct {
  - char [x\\_tvfill](#) [4]
  - char [x\\_tvlen](#) [2]
  - char [x\\_tvran](#) [2][2]
- } [x\\_tv](#)



### 5.21.1 Field Documentation

5.21.1.1 struct { ... } ::@27 COFF\_auxent::x\_ary

5.21.1.2 char COFF\_auxent::x\_dimen[E\_DIMNUM][2]

5.21.1.3 char COFF\_auxent::x\_endndx[4]

5.21.1.4 struct { ... } ::@26 COFF\_auxent::x\_fcn

5.21.1.5 union { ... } COFF\_auxent::x\_fcary

5.21.1.6 union { ... } COFF\_auxent::x\_file

5.21.1.7 char COFF\_auxent::x\_fname[E\_FILNMLEN]

5.21.1.8 char COFF\_auxent::x\_fsize[4]

5.21.1.9 char COFF\_auxent::x\_inno[2]

5.21.1.10 char COFF\_auxent::x\_innoptr[4]

5.21.1.11 struct { ... } ::@25 COFF\_auxent::x\_lnsz

5.21.1.12 union { ... } COFF\_auxent::x\_misc

5.21.1.13 struct { ... } COFF\_auxent::x\_n

5.21.1.14 char COFF\_auxent::x\_nlinno[2]

5.21.1.15 char COFF\_auxent::x\_nreloc[2]

5.21.1.16 char COFF\_auxent::x\_offset[4]

5.21.1.17 struct { ... } COFF\_auxent::x\_scn

5.21.1.18 char COFF\_auxent::x\_scnlen[4]

5.21.1.19 char COFF\_auxent::x\_size[2]

5.21.1.20 struct { ... } COFF\_auxent::x\_sym

5.21.1.21 char COFF\_auxent::x\_tagndx[4]

5.21.1.22 struct { ... } COFF\_auxent::x\_tv

5.21.1.23 char COFF\_auxent::x\_tvfill[4]

5.21.1.24 char COFF\_auxent::x\_tvlen[2]

5.21.1.25 char COFF\_auxent::x\_tvndx[2]

5.21.1.26 char COFF\_auxent::x\_tvran[2][2]

5.21.1.27 char COFF\_auxent::x\_zeroes[4]

---

Generated on Tue Feb 24 14:22:00 2009 for OrlinSim. The OpenRISC 1000 Architectural Simulator by Doxygen

The documentation for this union was generated from the following file:

- [cpu/common/coff.h](#)

## 5.22 COFF\_filehdr Struct Reference

```
#include <coff.h>
```

### Data Fields

- char [f\\_magic](#) [2]
- char [f\\_nscns](#) [2]
- char [f\\_timdat](#) [4]
- char [f\\_sympr](#) [4]
- char [f\\_nsyms](#) [4]
- char [f\\_opthdr](#) [2]
- char [f\\_flags](#) [2]

### 5.22.1 Field Documentation

**5.22.1.1** char COFF\_filehdr::f\_flags[2]

**5.22.1.2** char COFF\_filehdr::f\_magic[2]

**5.22.1.3** char COFF\_filehdr::f\_nscns[2]

**5.22.1.4** char COFF\_filehdr::f\_nsyms[4]

**5.22.1.5** char COFF\_filehdr::f\_opthdr[2]

**5.22.1.6** char COFF\_filehdr::f\_sympr[4]

**5.22.1.7** char COFF\_filehdr::f\_timdat[4]

The documentation for this struct was generated from the following file:

- [cpu/common/coff.h](#)

## 5.23 COFF\_lineno Struct Reference

```
#include <coff.h>
```

### Data Fields

- union {
  - char [l\\_symndx](#) [4]
  - char [l\\_paddr](#) [4] } [l\\_addr](#)
- char [l\\_inno](#) [2]

### 5.23.1 Field Documentation

**5.23.1.1 union { ... } COFF\_lineno::l\_addr**

**5.23.1.2 char COFF\_lineno::l\_inno[2]**

**5.23.1.3 char COFF\_lineno::l\_paddr[4]**

**5.23.1.4 char COFF\_lineno::l\_symndx[4]**

The documentation for this struct was generated from the following file:

- [cpu/common/coff.h](#)

## 5.24 COFF\_reloc Struct Reference

```
#include <coff.h>
```

### Data Fields

- char [r\\_vaddr](#) [4]
- char [r\\_symndx](#) [4]
- char [r\\_type](#) [2]

### 5.24.1 Field Documentation

**5.24.1.1** char COFF\_reloc::r\_symndx[4]

**5.24.1.2** char COFF\_reloc::r\_type[2]

**5.24.1.3** char COFF\_reloc::r\_vaddr[4]

The documentation for this struct was generated from the following file:

- [cpu/common/coff.h](#)

## 5.25 COFF\_scnhdr Struct Reference

```
#include <coff.h>
```

### Data Fields

- char [s\\_name](#) [8]
- char [s\\_paddr](#) [4]
- char [s\\_vaddr](#) [4]
- char [s\\_size](#) [4]
- char [s\\_scnptr](#) [4]
- char [s\\_relptr](#) [4]
- char [s\\_innoptr](#) [4]
- char [s\\_nreloc](#) [2]
- char [s\\_nlnno](#) [2]
- char [s\\_flags](#) [4]

### 5.25.1 Field Documentation

**5.25.1.1** char COFF\_scnhdr::s\_flags[4]

**5.25.1.2** char COFF\_scnhdr::s\_innoptr[4]

**5.25.1.3** char COFF\_scnhdr::s\_name[8]

**5.25.1.4** char COFF\_scnhdr::s\_nlnno[2]

**5.25.1.5** char COFF\_scnhdr::s\_nreloc[2]

**5.25.1.6** char COFF\_scnhdr::s\_paddr[4]

**5.25.1.7** char COFF\_scnhdr::s\_relptr[4]

**5.25.1.8** char COFF\_scnhdr::s\_scnptr[4]

**5.25.1.9** char COFF\_scnhdr::s\_size[4]

**5.25.1.10** char COFF\_scnhdr::s\_vaddr[4]

The documentation for this struct was generated from the following file:

- [cpu/common/coff.h](#)



## 5.26 COFF\_slib Struct Reference

```
#include <coff.h>
```

### Data Fields

- char [sl\\_entz](#) [4]
- char [sl\\_pathndx](#) [4]

### 5.26.1 Field Documentation

**5.26.1.1** char COFF\_slib::sl\_entz[4]

**5.26.1.2** char COFF\_slib::sl\_pathndx[4]

The documentation for this struct was generated from the following file:

- [cpu/common/coff.h](#)

## 5.27 COFF\_syment Struct Reference

```
#include <coff.h>
```

### Data Fields

- union {
  - char [e\\_name](#) [E\_SYMNMLEN]
  - struct {
    - char [e\\_zeroes](#) [4]
    - char [e\\_offset](#) [4]
  - } [e](#)
- char [e\\_value](#) [4]
- char [e\\_snum](#) [2]
- char [e\\_type](#) [2]
- char [e\\_sclass](#) [1]
- char [e\\_numaux](#) [1]

### 5.27.1 Field Documentation

**5.27.1.1** union { ... } COFF\_syment::e

**5.27.1.2** struct { ... } COFF\_syment::e

**5.27.1.3** char COFF\_syment::e\_name[E\_SYMNMLEN]

**5.27.1.4** char COFF\_syment::e\_numaux[1]

**5.27.1.5** char COFF\_syment::e\_offset[4]

**5.27.1.6** char COFF\_syment::e\_sclass[1]

**5.27.1.7** char COFF\_syment::e\_snum[2]

**5.27.1.8** char COFF\_syment::e\_type[2]

**5.27.1.9** char COFF\_syment::e\_value[4]

**5.27.1.10** char COFF\_syment::e\_zeroes[4]

The documentation for this struct was generated from the following file:

- [cpu/common/coff.h](#)

## 5.28 config Struct Reference

```
#include <sim-config.h>
```

Collaboration diagram for config:

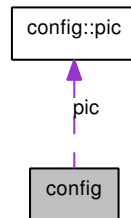

### Data Structures

- struct [pic](#)

### Data Fields

- struct {
  - void \* [class\\_ptr](#)
  - unsigned long int(\* [read\\_up](#))(void \*[class\\_ptr](#), unsigned long int addr, unsigned long int mask)
  - void(\* [write\\_up](#))(void \*[class\\_ptr](#), unsigned long int addr, unsigned long int mask, unsigned long int wdata)
 } [ext](#)
- struct {
  - int [debug](#)
  - int [verbose](#)
  - int [profile](#)
  - char \* [prof\\_fn](#)
  - int [mprofile](#)
  - char \* [mprof\\_fn](#)
  - int [history](#)
  - int [exe\\_log](#)
  - int [exe\\_log\\_type](#)
  - long long int [exe\\_log\\_start](#)
  - long long int [exe\\_log\\_end](#)
  - int [exe\\_log\\_marker](#)
  - char \* [exe\\_log\\_fn](#)
  - long [clkcycle\\_ps](#)
  - int [strict\\_npc](#)
 } [sim](#)
- struct {
  - int [enabled](#)
  - int [server\\_port](#)
  - int [log\\_enabled](#)
  - int [hide\\_device\\_id](#)
  - char \* [vapi\\_fn](#)
 } [vapi](#)

- struct {  
    char \* `timings_fn`  
    int `memory_order`  
    int `calling_convention`  
    int `enable_bursts`  
    int `no_multicycle`  
} `cuc`
- struct {  
    int `superscalar`  
    int `hazards`  
    int `dependstats`  
    int `sbuf_len`  
} `cpu`
- struct {  
    int `enabled`  
    int `nways`  
    int `nsets`  
    int `blocksize`  
    int `ustates`  
    int `store_missdelay`  
    int `store_hitdelay`  
    int `load_missdelay`  
    int `load_hitdelay`  
} `dc`
- struct `config::pic` `pic`
- struct {  
    int `enabled`  
} `pm`
- struct {  
    int `enabled`  
    int `sbp_bnf_fwd`  
    int `sbp_bf_fwd`  
    int `btic`  
    int `missdelay`  
    int `hitdelay`  
} `bpb`
- struct {  
    int `enabled`  
    int `gdb_enabled`  
    int `rsp_enabled`  
    int `server_port`  
    int `rsp_port`  
    unsigned long `vapi_id`  
} `debug`

### 5.28.1 Detailed Description

Data structure for configuration data



## 5.28.2 Field Documentation

- 5.28.2.1 `int config::blocksize`
- 5.28.2.2 `struct { ... } config::bpb`
- 5.28.2.3 `int config::btic`
- 5.28.2.4 `int config::calling_convention`
- 5.28.2.5 `void* config::class_ptr`
- 5.28.2.6 `long config::clkcycle_ps`
- 5.28.2.7 `struct { ... } config::cpu`
- 5.28.2.8 `struct { ... } config::cuc`
- 5.28.2.9 `struct { ... } config::dc`
- 5.28.2.10 `struct { ... } config::debug`
- 5.28.2.11 `int config::debug`
- 5.28.2.12 `int config::dependstats`
- 5.28.2.13 `int config::enable_bursts`
- 5.28.2.14 `int config::enabled`
- 5.28.2.15 `int config::exe_log`
- 5.28.2.16 `long long int config::exe_log_end`
- 5.28.2.17 `char* config::exe_log_fn`
- 5.28.2.18 `int config::exe_log_marker`
- 5.28.2.19 `long long int config::exe_log_start`
- 5.28.2.20 `int config::exe_log_type`
- 5.28.2.21 `struct { ... } config::ext`
- 5.28.2.22 `int config::gdb_enabled`
- 5.28.2.23 `int config::hazards`
- 5.28.2.24 `int config::hide_device_id`
- 5.28.2.25 `int config::history`
- 5.28.2.26 `int config::hitdelay`
- 5.28.2.27 `int config::load_hitdelay`
- 5.28.2.28 `int config::load_missdelay`
- 5.28.2.29 `int config::log_enabled`
- 5.28.2.30 `int config::memory_order`

- [sim-config.h](#)



## 5.29 config::pic Struct Reference

```
#include <sim-config.h>
```

### Data Fields

- int [enabled](#)
- int [edge\\_trigger](#)

### 5.29.1 Field Documentation

#### 5.29.1.1 int config::pic::edge\_trigger

#### 5.29.1.2 int config::pic::enabled

The documentation for this struct was generated from the following file:

- [sim-config.h](#)

## 5.30 config\_param Struct Reference

Collaboration diagram for config\_param:

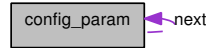

### Data Fields

- char \* [name](#)
- enum [param\\_t](#) [type](#)
- void(\* [func](#) )(union [param\\_val](#), void \*dat)
- struct [config\\_param](#) \* [next](#)

### 5.30.1 Field Documentation

**5.30.1.1** void(\* [config\\_param::func](#))(union [param\\_val](#), void \*dat)

**5.30.1.2** char\* [config\\_param::name](#)

**5.30.1.3** struct [config\\_param](#)\* [config\\_param::next](#) [[read](#)]

**5.30.1.4** enum [param\\_t](#) [config\\_param::type](#)

The documentation for this struct was generated from the following file:

- [sim-config.c](#)

## 5.31 config\_section Struct Reference

```
#include <sim-config.h>
```

Collaboration diagram for config\_section:

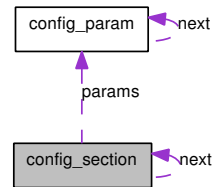

### Data Fields

- char \* `name`
- void \*(\* `sec_start`)(void)
- void(\* `sec_end`)(void \*)
- void \* `dat`
- struct `config_param` \* `params`
- struct `config_section` \* `next`

### 5.31.1 Field Documentation

**5.31.1.1** void\* `config_section::dat`

**5.31.1.2** char\* `config_section::name`

**5.31.1.3** struct `config_section`\* `config_section::next` [read]

**5.31.1.4** struct `config_param`\* `config_section::params` [read]

**5.31.1.5** void(\* `config_section::sec_end`)(void \*)

**5.31.1.6** void(\* `config_section::sec_start`)(void)

The documentation for this struct was generated from the following file:

- [sim-config.h](#)

## 5.32 cpu\_state Struct Reference

```
#include <execute.h>
```

Collaboration diagram for `cpu_state`:

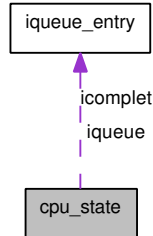

### Data Fields

- `uorreg_t reg` [MAX\_GPRS]
- `uorreg_t sprs` [MAX\_SPRS]
- `oraddr_t insn_ea`
- `int delay_insn`
- `int npc_not_valid`
- `oraddr_t pc`
- `oraddr_t pc_delay`
- `uint32_t pic_lines`
- `struct iqueue_entry iqueue`
- `struct iqueue_entry icomplet`

### 5.32.1 Detailed Description

The main structure holding the current execution state of the CPU

Not to be confused with `runtime`, which holds the state of the simulation.

`insn_ea` field is only used to get `dump_exe_log()` correct.

`iqueue` and `icomplet` fields are only used in `analysis()`.

The micro-operation queue, `opqs`, is only used to speed up `recompile_page()`.

### 5.32.2 Field Documentation

#### 5.32.2.1 int cpu\_state::delay\_insn

Is current instr in delay slot

#### 5.32.2.2 struct iqueue\_entry cpu\_state::icomplet [read]

Decode of instr before this

**5.32.2.3** `oraddr_t cpu_state::insn_ea`

EA of instrs that have an EA

**5.32.2.4** `struct iqueue_entry cpu_state::iqueue` [read]

Decode of just executed instr

**5.32.2.5** `int cpu_state::npc_not_valid`

NPC updated while stalled

**5.32.2.6** `oraddr_t cpu_state::pc`

PC (and translated PC)

**5.32.2.7** `oraddr_t cpu_state::pc_delay`

Delay instr EA register

**5.32.2.8** `uint32_t cpu_state::pic_lines`

State of PIC lines

**5.32.2.9** `uorreg_t cpu_state::reg[MAX_GPRS]`

General purpose registers

**5.32.2.10** `uorreg_t cpu_state::sprs[MAX_SPRS]`

Special purpose registers

The documentation for this struct was generated from the following file:

- [cpu/common/execute.h](#)

### 5.33 cuc\_bb Struct Reference

```
#include <cuc.h>
```

Collaboration diagram for cuc\_bb:

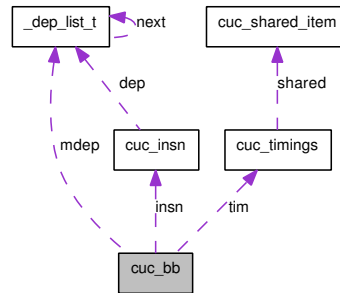

#### Data Fields

- unsigned long `type`
- int `first`
- int `last`
- int `prev` [2]
- int `next` [2]
- int `tmp`
- `cuc_insn` \* `insn`
- int `ninsn`
- int `last_used_reg` [MAX\_REGS]
- `dep_list` \* `mdep`
- int `nmemory`
- int `cnt`
- int `unrolled`
- int `ntim`
- `cuc_timings` \* `tim`
- int `selected_tim`

### 5.33.1 Field Documentation

5.33.1.1 int cuc\_bb::cnt

5.33.1.2 int cuc\_bb::first

5.33.1.3 cuc\_insn\* cuc\_bb::insn

5.33.1.4 int cuc\_bb::last

5.33.1.5 int cuc\_bb::last\_used\_reg[MAX\_REGS]

5.33.1.6 dep\_list\* cuc\_bb::mdep

5.33.1.7 int cuc\_bb::next[2]

5.33.1.8 int cuc\_bb::ninsn

5.33.1.9 int cuc\_bb::nmemory

5.33.1.10 int cuc\_bb::ntim

5.33.1.11 int cuc\_bb::prev[2]

5.33.1.12 int cuc\_bb::selected\_tim

5.33.1.13 cuc\_timings\* cuc\_bb::tim

5.33.1.14 int cuc\_bb::tmp

5.33.1.15 unsigned long cuc\_bb::type

5.33.1.16 int cuc\_bb::unrolled

The documentation for this struct was generated from the following file:

- [cuc/cuc.h](#)

## 5.34 `cuc_conv` Struct Reference

```
#include <insn.h>
```

### Data Fields

- const char \* [from](#)
- const int [to](#)

### 5.34.1 Field Documentation

#### 5.34.1.1 `const char* cuc_conv::from`

#### 5.34.1.2 `const int cuc_conv::to`

The documentation for this struct was generated from the following file:

- [cuc/insn.h](#)



## 5.35 cuc\_insn Struct Reference

```
#include <cuc.h>
```

Collaboration diagram for cuc\_insn:

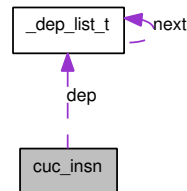

### Data Fields

- int `type`
- int `index`
- int `opt` [MAX\_OPERANDS]
- unsigned long `op` [MAX\_OPERANDS]
- `dep_list * dep`
- unsigned long `insn`
- char `disasm` [40]
- unsigned long `max`
- int `tmp`

### 5.35.1 Field Documentation

5.35.1.1 `dep_list* cuc_insn::dep`

5.35.1.2 `char cuc_insn::disasm[40]`

5.35.1.3 `int cuc_insn::index`

5.35.1.4 `unsigned long cuc_insn::insn`

5.35.1.5 `unsigned long cuc_insn::max`

5.35.1.6 `unsigned long cuc_insn::op[MAX_OPERANDS]`

5.35.1.7 `int cuc_insn::opt[MAX_OPERANDS]`

5.35.1.8 `int cuc_insn::tmp`

5.35.1.9 `int cuc_insn::type`

The documentation for this struct was generated from the following file:

- [cuc/cuc.h](#)

## 5.36 `cuc_known_insn` Struct Reference

```
#include <insn.h>
```

### Data Fields

- char \* [name](#)
- int [comutative](#)
- char \* [rtl](#)

### 5.36.1 Field Documentation

**5.36.1.1** int `cuc_known_insn::comutative`

**5.36.1.2** char\* `cuc_known_insn::name`

**5.36.1.3** char\* `cuc_known_insn::rtl`

The documentation for this struct was generated from the following file:

- [cuc/insn.h](#)

## 5.37 `cuc_shared_item` Struct Reference

```
#include <cuc.h>
```

### Data Fields

- `int ref`
- `int cmatch`

### 5.37.1 Field Documentation

#### 5.37.1.1 `int cuc_shared_item::cmatch`

#### 5.37.1.2 `int cuc_shared_item::ref`

The documentation for this struct was generated from the following file:

- `cuc/cuc.h`

## 5.38 `cuc_timing_table` Struct Reference

```
#include <insn.h>
```

### Data Fields

- double [delay](#)
- double [size](#)
- double [delayi](#)
- double [sizei](#)

### 5.38.1 Field Documentation

**5.38.1.1** double `cuc_timing_table::delay`

**5.38.1.2** double `cuc_timing_table::delayi`

**5.38.1.3** double `cuc_timing_table::size`

**5.38.1.4** double `cuc_timing_table::sizei`

The documentation for this struct was generated from the following file:

- [cuc/insn.h](#)

## 5.39 cuc\_timings Struct Reference

```
#include <cuc.h>
```

Collaboration diagram for cuc\_timings:

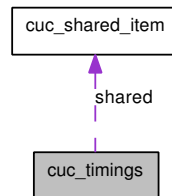

### Data Fields

- int [b](#)
- int [preroll](#)
- int [unroll](#)
- int [nshared](#)
- [cuc\\_shared\\_item](#) \* [shared](#)
- int [new\\_time](#)
- double [size](#)

### 5.39.1 Field Documentation

**5.39.1.1** int [cuc\\_timings::b](#)

**5.39.1.2** int [cuc\\_timings::new\\_time](#)

**5.39.1.3** int [cuc\\_timings::nshared](#)

**5.39.1.4** int [cuc\\_timings::preroll](#)

**5.39.1.5** [cuc\\_shared\\_item](#)\* [cuc\\_timings::shared](#)

**5.39.1.6** double [cuc\\_timings::size](#)

**5.39.1.7** int [cuc\\_timings::unroll](#)

The documentation for this struct was generated from the following file:

- [cuc/cuc.h](#)

## 5.40 dc\_set Struct Reference

### Data Fields

- struct {
  - uint32\_t [line](#) [MAX\_DC\_BLOCK\_SIZE/4]
  - [oraddr\\_t](#) [tagaddr](#)
  - int [lru](#)
- } [way](#) [MAX\_DC\_WAYS]

### 5.40.1 Field Documentation

**5.40.1.1** [uint32\\_t dc\\_set::line](#)[MAX\_DC\_BLOCK\_SIZE/4]

**5.40.1.2** [int dc\\_set::lru](#)

**5.40.1.3** [oraddr\\_t dc\\_set::tagaddr](#)

**5.40.1.4** [struct { ... } dc\\_set::way](#)[MAX\_DC\_WAYS]

The documentation for this struct was generated from the following file:

- [cache/dcache-model.c](#)

## 5.41 dev\_16450 Struct Reference

Collaboration diagram for dev\_16450:

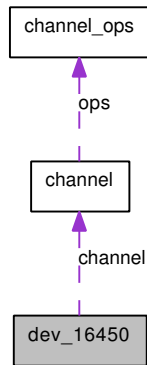

### Data Fields

- struct {
  - uint8\_t `txbuf` [UART\_MAX\_FIFO\_LEN]
  - uint16\_t `rxbuf` [UART\_MAX\_FIFO\_LEN]
  - uint8\_t `dll`
  - uint8\_t `dlh`
  - uint8\_t `ier`
  - uint8\_t `iir`
  - uint8\_t `fcr`
  - uint8\_t `lcr`
  - uint8\_t `mcr`
  - uint8\_t `lsr`
  - uint8\_t `msr`
  - uint8\_t `scr`
 } `regs`
- struct {
  - uint8\_t `txser`
  - uint16\_t `rxser`
  - uint8\_t `loopback`
 } `iregs`
- struct {
  - int `txbuf_head`
  - int `txbuf_tail`
  - int `rxbuf_head`
  - int `rxbuf_tail`
  - unsigned int `txbuf_full`
  - unsigned int `rxbuf_full`
  - int `receiveing`
  - int `recv_break`
  - int `ints`
 } `istat`

- unsigned long `char_clks`
- struct {
  - unsigned long `char_clks`
  - uint8\_t `dll`
  - uint8\_t `dlh`
  - uint8\_t `lcr`
  - int `skew`} `vapi`
- unsigned long `vapi_buf` [UART\_VAPI\_BUF\_LEN]
- int `vapi_buf_head_ptr`
- int `vapi_buf_tail_ptr`
- int `fifo_len`
- struct `channel` \* `channel`
- int `enabled`
- int `jitter`
- `oraddr_t` `baseaddr`
- int `irq`
- unsigned long `vapi_id`
- int `uart16550`
- char \* `channel_str`





### 5.41.1 Field Documentation

- 5.41.1.1 `oraddr_t dev_16450::baseaddr`
- 5.41.1.2 `struct channel* dev_16450::channel` [read]
- 5.41.1.3 `char* dev_16450::channel_str`
- 5.41.1.4 `unsigned long dev_16450::char_clks`
- 5.41.1.5 `uint8_t dev_16450::dlh`
- 5.41.1.6 `uint8_t dev_16450::dll`
- 5.41.1.7 `int dev_16450::enabled`
- 5.41.1.8 `uint8_t dev_16450::fcr`
- 5.41.1.9 `int dev_16450::fifo_len`
- 5.41.1.10 `uint8_t dev_16450::ier`
- 5.41.1.11 `uint8_t dev_16450::iir`
- 5.41.1.12 `int dev_16450::ints`
- 5.41.1.13 `struct { ... } dev_16450::iregs`
- 5.41.1.14 `int dev_16450::irq`
- 5.41.1.15 `struct { ... } dev_16450::istat`
- 5.41.1.16 `int dev_16450::jitter`
- 5.41.1.17 `uint8_t dev_16450::lcr`
- 5.41.1.18 `uint8_t dev_16450::loopback`
- 5.41.1.19 `uint8_t dev_16450::lsr`
- 5.41.1.20 `uint8_t dev_16450::mcr`
- 5.41.1.21 `uint8_t dev_16450::msr`
- 5.41.1.22 `int dev_16450::receiveing`
- 5.41.1.23 `int dev_16450::recv_break`
- 5.41.1.24 `struct { ... } dev_16450::regs`
- 5.41.1.25 `uint16_t dev_16450::rxbuf[UART_MAX_FIFO_LEN]`
- 5.41.1.26 `unsigned int dev_16450::rxbuf_full`
- 5.41.1.27 `int dev_16450::rxbuf_head`
- 5.41.1.28 `int dev_16450::rxbuf_tail`
- 5.41.1.29 `uint16_t dev_16450::rxser`
- 5.41.1.30 `uint8_t dev_16450::scr`

- [peripheral/16450.c](#)

## 5.42 dev\_generic Struct Reference

### Public Types

- enum { [GENERIC\\_READ](#), [GENERIC\\_WRITE](#) }
- enum { [GENERIC\\_BYTE](#), [GENERIC\\_HW](#), [GENERIC\\_WORD](#) }

### Data Fields

- enum dev\_generic:: { ... } [trans\\_direction](#)
- enum dev\_generic:: { ... } [trans\\_size](#)
- uint32\_t [value](#)
- int [enabled](#)
- int [byte\\_enabled](#)
- int [hw\\_enabled](#)
- int [word\\_enabled](#)
- char \* [name](#)
- oraddr\_t [baseaddr](#)
- uint32\_t [size](#)

### 5.42.1 Detailed Description

State associated with the generic device.

### 5.42.2 Member Enumeration Documentation

#### 5.42.2.1 anonymous enum

Enumerator:

*GENERIC\_READ*

*GENERIC\_WRITE*

#### 5.42.2.2 anonymous enum

Enumerator:

*GENERIC\_BYTE*

*GENERIC\_HW*

*GENERIC\_WORD*

### 5.42.3 Field Documentation

5.42.3.1 `oraddr_t dev_generic::baseaddr`

5.42.3.2 `int dev_generic::byte_enabled`

5.42.3.3 `int dev_generic::enabled`

5.42.3.4 `int dev_generic::hw_enabled`

5.42.3.5 `char* dev_generic::name`

5.42.3.6 `uint32_t dev_generic::size`

5.42.3.7 `enum { ... } dev_generic::trans_direction`

5.42.3.8 `enum { ... } dev_generic::trans_size`

5.42.3.9 `uint32_t dev_generic::value`

5.42.3.10 `int dev_generic::word_enabled`

The documentation for this struct was generated from the following file:

- [peripheral/generic.c](#)

## 5.43 dev\_memarea Struct Reference

```
#include <abstract.h>
```

Collaboration diagram for dev\_memarea:

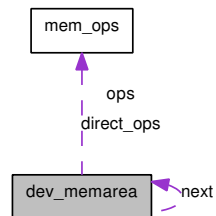

### Data Fields

- struct dev\_memarea \* next
- oraddr\_t addr\_mask
- oraddr\_t addr\_compare
- uint32\_t size
- oraddr\_t size\_mask
- int valid
- FILE \* log
- struct mem\_ops ops
- struct mem\_ops direct\_ops

#### 5.43.1 Detailed Description

Memory regions assigned to devices

## 5.43.2 Field Documentation

5.43.2.1 oraddr\_t dev\_memarea::addr\_compare

5.43.2.2 oraddr\_t dev\_memarea::addr\_mask

5.43.2.3 struct mem\_ops dev\_memarea::direct\_ops [read]

5.43.2.4 FILE\* dev\_memarea::log

5.43.2.5 struct dev\_memarea\* dev\_memarea::next [read]

5.43.2.6 struct mem\_ops dev\_memarea::ops [read]

5.43.2.7 uint32\_t dev\_memarea::size

5.43.2.8 oraddr\_t dev\_memarea::size\_mask

5.43.2.9 int dev\_memarea::valid

The documentation for this struct was generated from the following file:

- [cpu/common/abstract.h](#)

## 5.44 dma\_channel Struct Reference

```
#include <dma.h>
```

Collaboration diagram for dma\_channel:

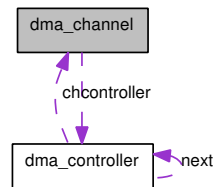

### Data Fields

- struct [dma\\_controller](#) \* controller
- unsigned [channel\\_number](#)
- unsigned long [channel\\_mask](#)
- unsigned [referenced](#)
- unsigned [load\\_next\\_descriptor\\_when\\_done](#)
- unsigned long [current\\_descriptor](#)
- [oraddr\\_t](#) source
- [oraddr\\_t](#) destination
- [oraddr\\_t](#) source\_mask
- [oraddr\\_t](#) destination\_mask
- unsigned long [chunk\\_size](#)
- unsigned long [total\\_size](#)
- unsigned long [words\\_transferred](#)
- struct {
  - unsigned long [csr](#)
  - unsigned long [sz](#)
  - unsigned long [a0](#)
  - unsigned long [am0](#)
  - unsigned long [a1](#)
  - unsigned long [am1](#)
  - unsigned long [desc](#)
  - unsigned long [swptr](#)
- } [regs](#)
- unsigned [dma\\_req\\_i](#)
- unsigned [dma\\_ack\\_o](#)
- unsigned [dma\\_nd\\_i](#)



### 5.44.1 Field Documentation

- 5.44.1.1 unsigned long dma\_channel::a0
- 5.44.1.2 unsigned long dma\_channel::a1
- 5.44.1.3 unsigned long dma\_channel::am0
- 5.44.1.4 unsigned long dma\_channel::am1
- 5.44.1.5 unsigned long dma\_channel::channel\_mask
- 5.44.1.6 unsigned dma\_channel::channel\_number
- 5.44.1.7 unsigned long dma\_channel::chunk\_size
- 5.44.1.8 struct dma\_controller\* dma\_channel::controller [read]
- 5.44.1.9 unsigned long dma\_channel::csr
- 5.44.1.10 unsigned long dma\_channel::current\_descriptor
- 5.44.1.11 unsigned long dma\_channel::desc
- 5.44.1.12 oraddr\_t dma\_channel::destination
- 5.44.1.13 oraddr\_t dma\_channel::destination\_mask
- 5.44.1.14 unsigned dma\_channel::dma\_ack\_o
- 5.44.1.15 unsigned dma\_channel::dma\_nd\_i
- 5.44.1.16 unsigned dma\_channel::dma\_req\_i
- 5.44.1.17 unsigned dma\_channel::load\_next\_descriptor\_when\_done
- 5.44.1.18 unsigned dma\_channel::referenced
- 5.44.1.19 struct { ... } dma\_channel::regs
- 5.44.1.20 oraddr\_t dma\_channel::source
- 5.44.1.21 oraddr\_t dma\_channel::source\_mask
- 5.44.1.22 unsigned long dma\_channel::swptr
- 5.44.1.23 unsigned long dma\_channel::sz
- 5.44.1.24 unsigned long dma\_channel::total\_size
- 5.44.1.25 unsigned long dma\_channel::words\_transferred

The documentation for this struct was generated from the following file:

- [peripheral/dma.h](#)

## 5.45 dma\_controller Struct Reference

```
#include <dma.h>
```

Collaboration diagram for dma\_controller:

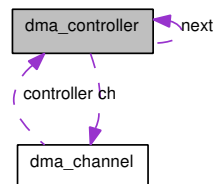

### Data Fields

- int `enabled`
- `oraddr_t` `baseaddr`
- unsigned `irq`
- int `vapi_id`
- struct {
  - unsigned long `csr`
  - unsigned long `int_msk_a`
  - unsigned long `int_msk_b`
  - unsigned long `int_src_a`
  - unsigned long `int_src_b`} `regs`
- struct `dma_channel` `ch` [DMA\_NUM\_CHANNELS]
- struct `dma_controller` \* `next`

## 5.45.1 Field Documentation

5.45.1.1 `oraddr_t dma_controller::baseaddr`

5.45.1.2 `struct dma_channel dma_controller::ch[DMA_NUM_CHANNELS]` [read]

5.45.1.3 `unsigned long dma_controller::csr`

5.45.1.4 `int dma_controller::enabled`

5.45.1.5 `unsigned long dma_controller::int_msk_a`

5.45.1.6 `unsigned long dma_controller::int_msk_b`

5.45.1.7 `unsigned long dma_controller::int_src_a`

5.45.1.8 `unsigned long dma_controller::int_src_b`

5.45.1.9 `unsigned dma_controller::irq`

5.45.1.10 `struct dma_controller* dma_controller::next` [read]

5.45.1.11 `struct { ... } dma_controller::regs`

5.45.1.12 `int dma_controller::vapi_id`

The documentation for this struct was generated from the following file:

- [peripheral/dma.h](#)

## 5.46 dmmu Struct Reference

```
#include <dmmu.h>
```

### Data Fields

- int `enabled`
- int `nways`
- int `nsets`
- int `pagesize`
- int `pagesize_log2`
- oraddr\_t `page_offset_mask`
- oraddr\_t `page_mask`
- oraddr\_t `vpn_mask`
- int `lru_reload`
- oraddr\_t `set_mask`
- int `entrysize`
- int `ustates`
- int `missdelay`
- int `hitdelay`

## 5.46.1 Field Documentation

5.46.1.1 int dmmu::enabled

5.46.1.2 int dmmu::entrysize

5.46.1.3 int dmmu::hitdelay

5.46.1.4 int dmmu::lru\_reload

5.46.1.5 int dmmu::missdelay

5.46.1.6 int dmmu::nsets

5.46.1.7 int dmmu::nways

5.46.1.8 oraddr\_t dmmu::page\_mask

5.46.1.9 oraddr\_t dmmu::page\_offset\_mask

5.46.1.10 int dmmu::pagesize

5.46.1.11 int dmmu::pagesize\_log2

5.46.1.12 oraddr\_t dmmu::set\_mask

5.46.1.13 int dmmu::ustates

5.46.1.14 oraddr\_t dmmu::vpn\_mask

The documentation for this struct was generated from the following file:

- [mmu/dmmu.h](#)

## 5.47 dmmustats\_entry Struct Reference

```
#include <stats.h>
```

### Data Fields

- int [loads\\_tlbhit](#)
- int [loads\\_tlbmiss](#)
- int [loads\\_pagefaults](#)
- int [stores\\_tlbhit](#)
- int [stores\\_tlbmiss](#)
- int [stores\\_pagefaults](#)

### 5.47.1 Field Documentation

**5.47.1.1** int dmmustats\_entry::loads\_pagefaults

**5.47.1.2** int dmmustats\_entry::loads\_tlbhit

**5.47.1.3** int dmmustats\_entry::loads\_tlbmiss

**5.47.1.4** int dmmustats\_entry::stores\_pagefaults

**5.47.1.5** int dmmustats\_entry::stores\_tlbhit

**5.47.1.6** int dmmustats\_entry::stores\_tlbmiss

The documentation for this struct was generated from the following file:

- [cpu/common/stats.h](#)

## 5.48 dstats\_entry Struct Reference

### Data Fields

- int [insn1](#)
- int [insn2](#)
- int [cnt\\_dynamic](#)
- int [depend](#)

### 5.48.1 Field Documentation

5.48.1.1 int dstats\_entry::cnt\_dynamic

5.48.1.2 int dstats\_entry::depend

5.48.1.3 int dstats\_entry::insn1

5.48.1.4 int dstats\_entry::insn2

The documentation for this struct was generated from the following file:

- [cpu/common/stats.c](#)



## 5.49 dyn\_page Struct Reference

```
#include <dyn-rec.h>
```

### Data Fields

- [oraddr\\_t or\\_page](#)
- void \* [host\\_page](#)
- unsigned int [host\\_len](#)
- int [dirty](#)
- int [delayr](#)
- uint16\_t [ts\\_bound](#) [2049]
- void \*\* [locs](#)
- uint32\_t \* [insns](#)
- unsigned int \* [insn\\_indexes](#)

### 5.49.1 Field Documentation

**5.49.1.1 int dyn\_page::delayr**

**5.49.1.2 int dyn\_page::dirty**

**5.49.1.3 unsigned int dyn\_page::host\_len**

**5.49.1.4 void\* dyn\_page::host\_page**

**5.49.1.5 unsigned int\* dyn\_page::insn\_indexes**

**5.49.1.6 uint32\_t\* dyn\_page::insns**

**5.49.1.7 void\*\* dyn\_page::locs**

**5.49.1.8 oraddr\_t dyn\_page::or\_page**

**5.49.1.9 uint16\_t dyn\_page::ts\_bound[2049]**

The documentation for this struct was generated from the following file:

- [cpu/or32/dyn-rec.h](#)

## 5.50 dynamic Struct Reference

```
#include <elf.h>
```

### Data Fields

- [Elf32\\_Sword d\\_tag](#)
- union {
  - [Elf32\\_Sword d\\_val](#)
  - [Elf32\\_Addr d\\_ptr](#)
- [d\\_un](#)

### 5.50.1 Field Documentation

#### 5.50.1.1 Elf32\_Addr dynamic::d\_ptr

#### 5.50.1.2 Elf32\_Sword dynamic::d\_tag

#### 5.50.1.3 union { ... } dynamic::d\_un

#### 5.50.1.4 Elf32\_Sword dynamic::d\_val

The documentation for this struct was generated from the following file:

- [cpu/common/elf.h](#)

## 5.51 elf32\_hdr Struct Reference

```
#include <elf.h>
```

### Data Fields

- unsigned char [e\\_ident](#) [EI\_NIDENT]
- [Elf32\\_Half e\\_type](#)
- [Elf32\\_Half e\\_machine](#)
- [Elf32\\_Word e\\_version](#)
- [Elf32\\_Addr e\\_entry](#)
- [Elf32\\_Off e\\_phoff](#)
- [Elf32\\_Off e\\_shoff](#)
- [Elf32\\_Word e\\_flags](#)
- [Elf32\\_Half e\\_ehsize](#)
- [Elf32\\_Half e\\_phentsize](#)
- [Elf32\\_Half e\\_phnum](#)
- [Elf32\\_Half e\\_shentsize](#)
- [Elf32\\_Half e\\_shnum](#)
- [Elf32\\_Half e\\_shstrndx](#)

### 5.51.1 Field Documentation

- 5.51.1.1 Elf32\_Half elf32\_hdr::e\_ehsize
- 5.51.1.2 Elf32\_Addr elf32\_hdr::e\_entry
- 5.51.1.3 Elf32\_Word elf32\_hdr::e\_flags
- 5.51.1.4 unsigned char elf32\_hdr::e\_ident[EI\_NIDENT]
- 5.51.1.5 Elf32\_Half elf32\_hdr::e\_machine
- 5.51.1.6 Elf32\_Half elf32\_hdr::e\_phentsize
- 5.51.1.7 Elf32\_Half elf32\_hdr::e\_phnum
- 5.51.1.8 Elf32\_Off elf32\_hdr::e\_phoff
- 5.51.1.9 Elf32\_Half elf32\_hdr::e\_shentsize
- 5.51.1.10 Elf32\_Half elf32\_hdr::e\_shnum
- 5.51.1.11 Elf32\_Off elf32\_hdr::e\_shoff
- 5.51.1.12 Elf32\_Half elf32\_hdr::e\_shstrndx
- 5.51.1.13 Elf32\_Half elf32\_hdr::e\_type
- 5.51.1.14 Elf32\_Word elf32\_hdr::e\_version

The documentation for this struct was generated from the following file:

- [cpu/common/elf.h](#)

## 5.52 elf32\_note Struct Reference

```
#include <elf.h>
```

### Data Fields

- [Elf32\\_Word n\\_namesz](#)
- [Elf32\\_Word n\\_descsz](#)
- [Elf32\\_Word n\\_type](#)

### 5.52.1 Field Documentation

**5.52.1.1** [Elf32\\_Word elf32\\_note::n\\_descsz](#)

**5.52.1.2** [Elf32\\_Word elf32\\_note::n\\_namesz](#)

**5.52.1.3** [Elf32\\_Word elf32\\_note::n\\_type](#)

The documentation for this struct was generated from the following file:

- [cpu/common/elf.h](#)

## 5.53 elf32\_phdr Struct Reference

```
#include <elf.h>
```

### Data Fields

- [Elf32\\_Word p\\_type](#)
- [Elf32\\_Off p\\_offset](#)
- [Elf32\\_Addr p\\_vaddr](#)
- [Elf32\\_Addr p\\_paddr](#)
- [Elf32\\_Word p\\_filesz](#)
- [Elf32\\_Word p\\_memsz](#)
- [Elf32\\_Word p\\_flags](#)
- [Elf32\\_Word p\\_align](#)

### 5.53.1 Field Documentation

**5.53.1.1 Elf32\_Word elf32\_phdr::p\_align**

**5.53.1.2 Elf32\_Word elf32\_phdr::p\_filesz**

**5.53.1.3 Elf32\_Word elf32\_phdr::p\_flags**

**5.53.1.4 Elf32\_Word elf32\_phdr::p\_memsz**

**5.53.1.5 Elf32\_Off elf32\_phdr::p\_offset**

**5.53.1.6 Elf32\_Addr elf32\_phdr::p\_paddr**

**5.53.1.7 Elf32\_Word elf32\_phdr::p\_type**

**5.53.1.8 Elf32\_Addr elf32\_phdr::p\_vaddr**

The documentation for this struct was generated from the following file:

- [cpu/common/elf.h](#)

## 5.54 elf32\_rel Struct Reference

```
#include <elf.h>
```

### Data Fields

- [Elf32\\_Addr r\\_offset](#)
- [Elf32\\_Word r\\_info](#)

### 5.54.1 Field Documentation

#### 5.54.1.1 Elf32\_Word elf32\_rel::r\_info

#### 5.54.1.2 Elf32\_Addr elf32\_rel::r\_offset

The documentation for this struct was generated from the following file:

- [cpu/common/elf.h](#)

## 5.55 elf32\_rela Struct Reference

```
#include <elf.h>
```

### Data Fields

- [Elf32\\_Addr r\\_offset](#)
- [Elf32\\_Word r\\_info](#)
- [Elf32\\_Sword r\\_addend](#)

### 5.55.1 Field Documentation

**5.55.1.1 Elf32\_Sword elf32\_rela::r\_addend**

**5.55.1.2 Elf32\_Word elf32\_rela::r\_info**

**5.55.1.3 Elf32\_Addr elf32\_rela::r\_offset**

The documentation for this struct was generated from the following file:

- [cpu/common/elf.h](#)



## 5.56 elf32\_shdr Struct Reference

```
#include <elf.h>
```

### Data Fields

- [Elf32\\_Word sh\\_name](#)
- [Elf32\\_Word sh\\_type](#)
- [Elf32\\_Word sh\\_flags](#)
- [Elf32\\_Addr sh\\_addr](#)
- [Elf32\\_Off sh\\_offset](#)
- [Elf32\\_Word sh\\_size](#)
- [Elf32\\_Word sh\\_link](#)
- [Elf32\\_Word sh\\_info](#)
- [Elf32\\_Word sh\\_addralign](#)
- [Elf32\\_Word sh\\_entsize](#)

### 5.56.1 Field Documentation

**5.56.1.1** Elf32\_Addr elf32\_shdr::sh\_addr

**5.56.1.2** Elf32\_Word elf32\_shdr::sh\_addralign

**5.56.1.3** Elf32\_Word elf32\_shdr::sh\_entsize

**5.56.1.4** Elf32\_Word elf32\_shdr::sh\_flags

**5.56.1.5** Elf32\_Word elf32\_shdr::sh\_info

**5.56.1.6** Elf32\_Word elf32\_shdr::sh\_link

**5.56.1.7** Elf32\_Word elf32\_shdr::sh\_name

**5.56.1.8** Elf32\_Off elf32\_shdr::sh\_offset

**5.56.1.9** Elf32\_Word elf32\_shdr::sh\_size

**5.56.1.10** Elf32\_Word elf32\_shdr::sh\_type

The documentation for this struct was generated from the following file:

- [cpu/common/elf.h](#)

## 5.57 elf32\_sym Struct Reference

```
#include <elf.h>
```

### Data Fields

- [Elf32\\_Word st\\_name](#)
- [Elf32\\_Addr st\\_value](#)
- [Elf32\\_Word st\\_size](#)
- unsigned char [st\\_info](#)
- unsigned char [st\\_other](#)
- [Elf32\\_Half st\\_shndx](#)

### 5.57.1 Field Documentation

**5.57.1.1** unsigned char `elf32_sym::st_info`

**5.57.1.2** [Elf32\\_Word](#) `elf32_sym::st_name`

**5.57.1.3** unsigned char `elf32_sym::st_other`

**5.57.1.4** [Elf32\\_Half](#) `elf32_sym::st_shndx`

**5.57.1.5** [Elf32\\_Word](#) `elf32_sym::st_size`

**5.57.1.6** [Elf32\\_Addr](#) `elf32_sym::st_value`

The documentation for this struct was generated from the following file:

- [cpu/common/elf.h](#)

## 5.58 Elf64\_Dyn Struct Reference

```
#include <elf.h>
```

### Data Fields

- unsigned long long [d\\_tag](#)
- union {
  - unsigned long long [d\\_val](#)
  - unsigned long long [d\\_ptr](#)
- } [d\\_un](#)

### 5.58.1 Field Documentation

**5.58.1.1 unsigned long long Elf64\_Dyn::d\_ptr**

**5.58.1.2 unsigned long long Elf64\_Dyn::d\_tag**

**5.58.1.3 union { ... } Elf64\_Dyn::d\_un**

**5.58.1.4 unsigned long long Elf64\_Dyn::d\_val**

The documentation for this struct was generated from the following file:

- [cpu/common/elf.h](#)

## 5.59 elf64\_hdr Struct Reference

```
#include <elf.h>
```

### Data Fields

- unsigned char [e\\_ident](#) [16]
- short int [e\\_type](#)
- short unsigned int [e\\_machine](#)
- int [e\\_version](#)
- unsigned long long [e\\_entry](#)
- unsigned long long [e\\_phoff](#)
- unsigned long long [e\\_shoff](#)
- int [e\\_flags](#)
- short int [e\\_ehsize](#)
- short int [e\\_phentsize](#)
- short int [e\\_phnum](#)
- short int [e\\_shentsize](#)
- short int [e\\_shnum](#)
- short int [e\\_shstrndx](#)

## 5.59.1 Field Documentation

- 5.59.1.1 short int elf64\_hdr::e\_ehsize
- 5.59.1.2 unsigned long long elf64\_hdr::e\_entry
- 5.59.1.3 int elf64\_hdr::e\_flags
- 5.59.1.4 unsigned char elf64\_hdr::e\_ident[16]
- 5.59.1.5 short unsigned int elf64\_hdr::e\_machine
- 5.59.1.6 short int elf64\_hdr::e\_phentsize
- 5.59.1.7 short int elf64\_hdr::e\_phnum
- 5.59.1.8 unsigned long long elf64\_hdr::e\_phoff
- 5.59.1.9 short int elf64\_hdr::e\_shentsize
- 5.59.1.10 short int elf64\_hdr::e\_shnum
- 5.59.1.11 unsigned long long elf64\_hdr::e\_shoff
- 5.59.1.12 short int elf64\_hdr::e\_shstrndx
- 5.59.1.13 short int elf64\_hdr::e\_type
- 5.59.1.14 int elf64\_hdr::e\_version

The documentation for this struct was generated from the following file:

- [cpu/common/elf.h](#)

## 5.60 elf64\_note Struct Reference

```
#include <elf.h>
```

### Data Fields

- unsigned int [n\\_namesz](#)
- unsigned int [n\\_descsz](#)
- unsigned int [n\\_type](#)

### 5.60.1 Field Documentation

**5.60.1.1** unsigned int `elf64_note::n_descsz`

**5.60.1.2** unsigned int `elf64_note::n_namesz`

**5.60.1.3** unsigned int `elf64_note::n_type`

The documentation for this struct was generated from the following file:

- [cpu/common/elf.h](#)

## 5.61 elf64\_phdr Struct Reference

```
#include <elf.h>
```

### Data Fields

- int [p\\_type](#)
- int [p\\_flags](#)
- unsigned long long [p\\_offset](#)
- unsigned long long [p\\_vaddr](#)
- unsigned long long [p\\_paddr](#)
- unsigned long long [p\\_filesz](#)
- unsigned long long [p\\_memsz](#)
- unsigned long long [p\\_align](#)

### 5.61.1 Field Documentation

**5.61.1.1 unsigned long long elf64\_phdr::p\_align**

**5.61.1.2 unsigned long long elf64\_phdr::p\_filesz**

**5.61.1.3 int elf64\_phdr::p\_flags**

**5.61.1.4 unsigned long long elf64\_phdr::p\_memsz**

**5.61.1.5 unsigned long long elf64\_phdr::p\_offset**

**5.61.1.6 unsigned long long elf64\_phdr::p\_paddr**

**5.61.1.7 int elf64\_phdr::p\_type**

**5.61.1.8 unsigned long long elf64\_phdr::p\_vaddr**

The documentation for this struct was generated from the following file:

- [cpu/common/elf.h](#)

## 5.62 elf64\_rel Struct Reference

```
#include <elf.h>
```

### Data Fields

- unsigned long long [r\\_offset](#)
- unsigned long long [r\\_info](#)

### 5.62.1 Field Documentation

#### 5.62.1.1 unsigned long long elf64\_rel::r\_info

#### 5.62.1.2 unsigned long long elf64\_rel::r\_offset

The documentation for this struct was generated from the following file:

- [cpu/common/elf.h](#)



## 5.63 elf64\_rela Struct Reference

```
#include <elf.h>
```

### Data Fields

- unsigned long long [r\\_offset](#)
- unsigned long long [r\\_info](#)
- unsigned long long [r\\_addend](#)

### 5.63.1 Field Documentation

**5.63.1.1** unsigned long long `elf64_rela::r_addend`

**5.63.1.2** unsigned long long `elf64_rela::r_info`

**5.63.1.3** unsigned long long `elf64_rela::r_offset`

The documentation for this struct was generated from the following file:

- [cpu/common/elf.h](#)

## 5.64 elf64\_shdr Struct Reference

```
#include <elf.h>
```

### Data Fields

- unsigned int [sh\\_name](#)
- unsigned int [sh\\_type](#)
- unsigned long long [sh\\_flags](#)
- unsigned long long [sh\\_addr](#)
- unsigned long long [sh\\_offset](#)
- unsigned long long [sh\\_size](#)
- unsigned int [sh\\_link](#)
- unsigned int [sh\\_info](#)
- unsigned long long [sh\\_addralign](#)
- unsigned long long [sh\\_entsize](#)

### 5.64.1 Field Documentation

**5.64.1.1** unsigned long long `elf64_shdr::sh_addr`

**5.64.1.2** unsigned long long `elf64_shdr::sh_addralign`

**5.64.1.3** unsigned long long `elf64_shdr::sh_entsize`

**5.64.1.4** unsigned long long `elf64_shdr::sh_flags`

**5.64.1.5** unsigned int `elf64_shdr::sh_info`

**5.64.1.6** unsigned int `elf64_shdr::sh_link`

**5.64.1.7** unsigned int `elf64_shdr::sh_name`

**5.64.1.8** unsigned long long `elf64_shdr::sh_offset`

**5.64.1.9** unsigned long long `elf64_shdr::sh_size`

**5.64.1.10** unsigned int `elf64_shdr::sh_type`

The documentation for this struct was generated from the following file:

- `cpu/common/elf.h`

## 5.65 elf64\_sym Struct Reference

```
#include <elf.h>
```

### Data Fields

- unsigned int [st\\_name](#)
- unsigned char [st\\_info](#)
- unsigned char [st\\_other](#)
- unsigned short [st\\_shndx](#)
- unsigned long long [st\\_value](#)
- unsigned long long [st\\_size](#)

### 5.65.1 Field Documentation

**5.65.1.1** unsigned char `elf64_sym::st_info`

**5.65.1.2** unsigned int `elf64_sym::st_name`

**5.65.1.3** unsigned char `elf64_sym::st_other`

**5.65.1.4** unsigned short `elf64_sym::st_shndx`

**5.65.1.5** unsigned long long `elf64_sym::st_size`

**5.65.1.6** unsigned long long `elf64_sym::st_value`

The documentation for this struct was generated from the following file:

- [cpu/common/elf.h](#)

## 5.66 elf\_obj Struct Reference

Collaboration diagram for elf\_obj:

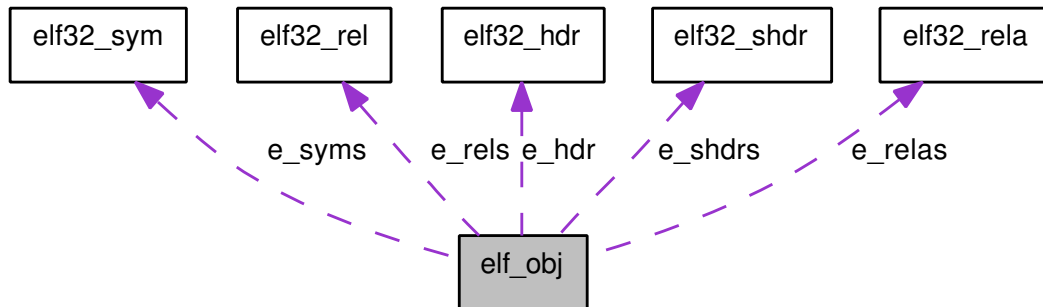

### Data Fields

- [Elf32\\_Ehdr](#) e\_hdr
- [Elf32\\_Shdr](#) \* e\_shdrs
- void \*\* e\_sections
- [Elf32\\_Sym](#) \* e\_syms
- unsigned int e\_sym\_num
- unsigned int e\_sym\_str\_tab
- [Elf32\\_Rel](#) \* e\_rels
- unsigned int e\_rel\_num
- unsigned int e\_rel\_sym
- unsigned int e\_rel\_sec
- [Elf32\\_Rela](#) \* e\_relas
- unsigned int e\_rela\_num
- unsigned int e\_rela\_sym
- unsigned int e\_rela\_sec

## 5.66.1 Field Documentation

5.66.1.1 Elf32\_Ehdr elf\_obj::e\_hdr

5.66.1.2 unsigned int elf\_obj::e\_rel\_num

5.66.1.3 unsigned int elf\_obj::e\_rel\_sec

5.66.1.4 unsigned int elf\_obj::e\_rel\_sym

5.66.1.5 unsigned int elf\_obj::e\_rela\_num

5.66.1.6 unsigned int elf\_obj::e\_rela\_sec

5.66.1.7 unsigned int elf\_obj::e\_rela\_sym

5.66.1.8 Elf32\_Rela\* elf\_obj::e\_relas

5.66.1.9 Elf32\_Rel\* elf\_obj::e\_rels

5.66.1.10 void\*\* elf\_obj::e\_sections

5.66.1.11 Elf32\_Shdr\* elf\_obj::e\_shdrs

5.66.1.12 unsigned int elf\_obj::e\_sym\_num

5.66.1.13 unsigned int elf\_obj::e\_sym\_str\_tab

5.66.1.14 Elf32\_Sym\* elf\_obj::e\_syms

The documentation for this struct was generated from the following file:

- [cpu/or32/dyngen-elf.c](#)

## 5.67 eth\_device Struct Reference

### Data Fields

- int `enabled`
- `oraddr_t` `baseaddr`
- unsigned `dma`
- unsigned `tx_channel`
- unsigned `rx_channel`
- unsigned char `mac_address` [ETHER\_ADDR\_LEN]
- unsigned long `mac_int`
- unsigned long `base_vapi_id`
- char \* `rxfile`
- char \* `txfile`
- int `txfd`
- int `rxfd`
- `off_t` `loopback_offset`
- char \* `sockif`
- int `rtx_sock`
- int `rtx_type`
- struct ifreq `ifr`
- `fd_set` `rfd`s
- `fd_set` `wfd`s
- struct {
  - unsigned long `state`
  - unsigned long `bd_index`
  - unsigned long `bd`
  - unsigned long `bd_addr`
  - unsigned `working`
  - unsigned `waiting_for_dma`
  - unsigned `error`
  - long `packet_length`
  - unsigned `minimum_length`
  - unsigned `maximum_length`
  - unsigned `add_crc`
  - unsigned `crc_dly`
  - unsigned long `crc_value`
  - long `bytes_left`
  - long `bytes_sent`
- } `tx`
- struct {
  - unsigned long `state`
  - unsigned long `bd_index`
  - unsigned long `bd`
  - unsigned long `bd_addr`
  - int `fd`
  - `off_t` \* `offset`
  - unsigned `working`
  - unsigned `error`
  - unsigned `waiting_for_dma`
  - long `packet_length`

```
    long bytes_read
    long bytes_left
} rx
```

- struct {
    - unsigned long moder
    - unsigned long int\_source
    - unsigned long int\_mask
    - unsigned long ipgt
    - unsigned long ipgr1
    - unsigned long ipgr2
    - unsigned long packetlen
    - unsigned long collconf
    - unsigned long tx\_bd\_num
    - unsigned long controlmoder
    - unsigned long miimoder
    - unsigned long miicommand
    - unsigned long miiaddress
    - unsigned long miitx\_data
    - unsigned long miirx\_data
    - unsigned long miistatus
    - unsigned long hash0
    - unsigned long hash1
    - unsigned long bd\_ram [ETH\_BD\_SPACE/4]
- ```
} regs
```

- unsigned char rx\_buff [ETH\_MAXPL]

- unsigned char tx\_buff [ETH\_MAXPL]

- unsigned char lo\_buff [ETH\_MAXPL]





## 5.67.1 Field Documentation

- 5.67.1.1 unsigned eth\_device::add\_crc
- 5.67.1.2 unsigned long eth\_device::base\_vapi\_id
- 5.67.1.3 oraddr\_t eth\_device::baseaddr
- 5.67.1.4 unsigned long eth\_device::bd
- 5.67.1.5 unsigned long eth\_device::bd\_addr
- 5.67.1.6 unsigned long eth\_device::bd\_index
- 5.67.1.7 unsigned long eth\_device::bd\_ram[ETH\_BD\_SPACE/4]
- 5.67.1.8 long eth\_device::bytes\_left
- 5.67.1.9 long eth\_device::bytes\_read
- 5.67.1.10 long eth\_device::bytes\_sent
- 5.67.1.11 unsigned long eth\_device::collconf
- 5.67.1.12 unsigned long eth\_device::controlmoder
- 5.67.1.13 unsigned eth\_device::crc\_dly
- 5.67.1.14 unsigned long eth\_device::crc\_value
- 5.67.1.15 unsigned eth\_device::dma
- 5.67.1.16 int eth\_device::enabled
- 5.67.1.17 unsigned eth\_device::error
- 5.67.1.18 int eth\_device::fd
- 5.67.1.19 unsigned long eth\_device::hash0
- 5.67.1.20 unsigned long eth\_device::hash1
- 5.67.1.21 struct ifreq eth\_device::ifr [read]
- 5.67.1.22 unsigned long eth\_device::int\_mask
- 5.67.1.23 unsigned long eth\_device::int\_source
- 5.67.1.24 unsigned long eth\_device::ipgr1
- 5.67.1.25 unsigned long eth\_device::ipgr2
- 5.67.1.26 unsigned long eth\_device::ipgt
- 5.67.1.27 unsigned char eth\_device::loopback\_offset
- 5.67.1.28 off\_t eth\_device::loopback\_offset
- 5.67.1.29 unsigned char eth\_device::mac\_address[ETHER\_ADDR\_LEN]
- 5.67.1.30 unsigned long eth\_device::mac\_int

- [peripheral/eth.c](#)

## 5.68 ether\_addr Struct Reference

### Data Fields

- `u_int8_t ether_addr_octet` [ETH\_ALEN]

### 5.68.1 Field Documentation

#### 5.68.1.1 `u_int8_t ether_addr::ether_addr_octet`[ETH\_ALEN]

The documentation for this struct was generated from the following file:

- `peripheral/eth.c`

## 5.69 ether\_header Struct Reference

### Data Fields

- `u_int8_t ether_dhost` [ETH\_ALEN]
- `u_int8_t ether_shost` [ETH\_ALEN]
- `u_int16_t ether_type`

### 5.69.1 Field Documentation

**5.69.1.1** `u_int8_t ether_header::ether_dhost`[ETH\_ALEN]

**5.69.1.2** `u_int8_t ether_header::ether_shost`[ETH\_ALEN]

**5.69.1.3** `u_int16_t ether_header::ether_type`

The documentation for this struct was generated from the following file:

- `peripheral/eth.c`

## 5.70 fb\_state Struct Reference

### Data Fields

- int `enabled`
- unsigned long `pal` [256]
- int `ctrl`
- int `pic`
- int `in_refresh`
- int `refresh_count`
- `oraddr_t` `addr`
- `oraddr_t` `cam_addr`
- int `camerax`
- int `cameray`
- int `camera_pos`
- `oraddr_t` `baseaddr`
- int `refresh`
- int `refresh_rate`
- char \* `filename`

## 5.70.1 Field Documentation

- 5.70.1.1 `oraddr_t fb_state::addr`
- 5.70.1.2 `oraddr_t fb_state::baseaddr`
- 5.70.1.3 `oraddr_t fb_state::cam_addr`
- 5.70.1.4 `int fb_state::camera_pos`
- 5.70.1.5 `int fb_state::camerax`
- 5.70.1.6 `int fb_state::cameray`
- 5.70.1.7 `int fb_state::ctrl`
- 5.70.1.8 `int fb_state::enabled`
- 5.70.1.9 `char* fb_state::filename`
- 5.70.1.10 `int fb_state::in_refresh`
- 5.70.1.11 `unsigned long fb_state::pal[256]`
- 5.70.1.12 `int fb_state::pic`
- 5.70.1.13 `int fb_state::refresh`
- 5.70.1.14 `int fb_state::refresh_count`
- 5.70.1.15 `int fb_state::refresh_rate`

The documentation for this struct was generated from the following file:

- [peripheral/fb.c](#)

## 5.71 fd\_channel Struct Reference

```
#include <fd.h>
```

### Data Fields

- int [fdin](#)
- int [fdout](#)

### 5.71.1 Detailed Description

Data structure to represent a [channel](#) through file descriptors

### 5.71.2 Field Documentation

#### 5.71.2.1 int fd\_channel::fdin

#### 5.71.2.2 int fd\_channel::fdout

The documentation for this struct was generated from the following file:

- [peripheral/channels/fd.h](#)

## 5.72 file\_channel Struct Reference

Collaboration diagram for file\_channel:

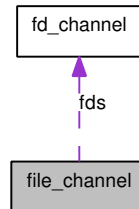

### Data Fields

- struct [fd\\_channel](#) `fds`
- char \* [namein](#)
- char \* [nameout](#)

### 5.72.1 Detailed Description

Data structure representing a [channel](#) to/from a file

### 5.72.2 Field Documentation

**5.72.2.1** struct [fd\\_channel](#) `file_channel::fds` [`read`]

**5.72.2.2** char\* `file_channel::namein`

**5.72.2.3** char\* `file_channel::nameout`

The documentation for this struct was generated from the following file:

- [peripheral/channels/file.c](#)



## 5.73 fstats\_entry Struct Reference

### Data Fields

- enum insn\_type [insn1](#)
- enum insn\_type [insn2](#)
- int [cnt\\_dynamic](#)
- int [depend](#)

### 5.73.1 Field Documentation

**5.73.1.1** int fstats\_entry::cnt\_dynamic

**5.73.1.2** int fstats\_entry::depend

**5.73.1.3** enum insn\_type fstats\_entry::insn1

**5.73.1.4** enum insn\_type fstats\_entry::insn2

The documentation for this struct was generated from the following file:

- [cpu/common/stats.c](#)

## 5.74 func\_struct Struct Reference

```
#include <profiler.h>
```

### Data Fields

- unsigned int [addr](#)
- char [name](#) [33]
- long [cum\\_cycles](#)
- long [calls](#)

### 5.74.1 Detailed Description

Data structure for information about functions

### 5.74.2 Field Documentation

#### 5.74.2.1 unsigned int func\_struct::addr

Start address of function

#### 5.74.2.2 long func\_struct::calls

Calls to this function

#### 5.74.2.3 long func\_struct::cum\_cycles

Total cycles spent in function

#### 5.74.2.4 char func\_struct::name[33]

Name of the function

The documentation for this struct was generated from the following file:

- [profiler.h](#)

## 5.75 gpio\_device Struct Reference

### Data Fields

- int `enabled`
- `oraddr_t` `baseaddr`
- int `irq`
- unsigned `gpio_number`
- unsigned long `base_vapi_id`
- unsigned long `auxiliary_inputs`
- struct {
  - unsigned long `in`
  - unsigned long `out`
  - unsigned long `oe`
  - unsigned long `inte`
  - unsigned long `ptrig`
  - unsigned long `aux`
  - unsigned long `ctrl`
  - unsigned long `ints`
  - int `external_clock`
- struct {
  - unsigned long `in`
  - unsigned long `out`
  - unsigned long `oe`
  - unsigned long `inte`
  - unsigned long `ptrig`
  - unsigned long `aux`
  - unsigned long `ctrl`
  - unsigned long `ints`
  - int `external_clock`

### 5.75.1 Field Documentation

- 5.75.1.1 unsigned long gpio\_device::aux
- 5.75.1.2 unsigned long gpio\_device::auxiliary\_inputs
- 5.75.1.3 unsigned long gpio\_device::base\_vapi\_id
- 5.75.1.4 oraddr\_t gpio\_device::baseaddr
- 5.75.1.5 unsigned long gpio\_device::ctrl
- 5.75.1.6 struct { ... } gpio\_device::curr
- 5.75.1.7 int gpio\_device::enabled
- 5.75.1.8 int gpio\_device::external\_clock
- 5.75.1.9 unsigned gpio\_device::gpio\_number
- 5.75.1.10 unsigned long gpio\_device::in
- 5.75.1.11 unsigned long gpio\_device::inte
- 5.75.1.12 unsigned long gpio\_device::ints
- 5.75.1.13 int gpio\_device::irq
- 5.75.1.14 struct { ... } gpio\_device::next
- 5.75.1.15 unsigned long gpio\_device::oe
- 5.75.1.16 unsigned long gpio\_device::out
- 5.75.1.17 unsigned long gpio\_device::ptrig

The documentation for this struct was generated from the following file:

- [peripheral/gpio.c](#)

## 5.76 hist\_exec Struct Reference

```
#include <execute.h>
```

Collaboration diagram for hist\_exec:

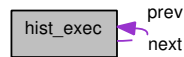

### Data Fields

- [oraddr\\_t addr](#)
- struct [hist\\_exec](#) \* [prev](#)
- struct [hist\\_exec](#) \* [next](#)

### 5.76.1 Detailed Description

History of execution

### 5.76.2 Field Documentation

#### 5.76.2.1 oraddr\_t hist\_exec::addr

**5.76.2.2** struct [hist\\_exec](#)\* [hist\\_exec::next](#) [read]

**5.76.2.3** struct [hist\\_exec](#)\* [hist\\_exec::prev](#) [read]

The documentation for this struct was generated from the following file:

- [cpu/common/execute.h](#)

## 5.77 ic Struct Reference

```
#include <icache-model.h>
```

### Data Fields

- uint8\_t \* [mem](#)
- unsigned int \* [lrus](#)
- [oraddr\\_t](#) \* [tags](#)
- int [enabled](#)
- unsigned int [nways](#)
- unsigned int [nsets](#)
- unsigned int [blocksize](#)
- unsigned int [ustates](#)
- int [missdelay](#)
- int [hitdelay](#)
- unsigned int [blocksize\\_log2](#)
- [oraddr\\_t](#) [set\\_mask](#)
- [oraddr\\_t](#) [tagaddr\\_mask](#)
- [oraddr\\_t](#) [last\\_way](#)
- [oraddr\\_t](#) [block\\_offset\\_mask](#)
- [oraddr\\_t](#) [block\\_mask](#)
- unsigned int [ustates\\_reload](#)

## 5.77.1 Field Documentation

5.77.1.1 oraddr\_t ic::block\_mask

5.77.1.2 oraddr\_t ic::block\_offset\_mask

5.77.1.3 unsigned int ic::blocksize

5.77.1.4 unsigned int ic::blocksize\_log2

5.77.1.5 int ic::enabled

5.77.1.6 int ic::hitdelay

5.77.1.7 oraddr\_t ic::last\_way

5.77.1.8 unsigned int\* ic::lrus

5.77.1.9 uint8\_t\* ic::mem

5.77.1.10 int ic::missdelay

5.77.1.11 unsigned int ic::nsets

5.77.1.12 unsigned int ic::nways

5.77.1.13 oraddr\_t ic::set\_mask

5.77.1.14 oraddr\_t ic::tagaddr\_mask

5.77.1.15 oraddr\_t\* ic::tags

5.77.1.16 unsigned int ic::ustates

5.77.1.17 unsigned int ic::ustates\_reload

The documentation for this struct was generated from the following file:

- [cache/icache-model.h](#)

## 5.78 immu Struct Reference

```
#include <immu.h>
```

### Data Fields

- int `enabled`
- int `nways`
- int `nsets`
- `oraddr_t` `pagesize`
- int `pagesize_log2`
- `oraddr_t` `page_offset_mask`
- `oraddr_t` `page_mask`
- `oraddr_t` `vpn_mask`
- int `lru_reload`
- `oraddr_t` `set_mask`
- int `entrysize`
- int `ustates`
- int `missdelay`
- int `hitdelay`



## 5.78.1 Field Documentation

5.78.1.1 `int immu::enabled`

5.78.1.2 `int immu::entrysize`

5.78.1.3 `int immu::hitdelay`

5.78.1.4 `int immu::lru_reload`

5.78.1.5 `int immu::missdelay`

5.78.1.6 `int immu::nsets`

5.78.1.7 `int immu::nways`

5.78.1.8 `oraddr_t immu::page_mask`

5.78.1.9 `oraddr_t immu::page_offset_mask`

5.78.1.10 `oraddr_t immu::pagesize`

5.78.1.11 `int immu::pagesize_log2`

5.78.1.12 `oraddr_t immu::set_mask`

5.78.1.13 `int immu::ustates`

5.78.1.14 `oraddr_t immu::vpn_mask`

The documentation for this struct was generated from the following file:

- [mmu/immu.h](#)

## 5.79 immustats\_entry Struct Reference

```
#include <stats.h>
```

### Data Fields

- int [fetch\\_tlbhit](#)
- int [fetch\\_tlbmiss](#)
- int [fetch\\_pagefaults](#)

### 5.79.1 Field Documentation

**5.79.1.1** int immustats\_entry::fetch\_pagefaults

**5.79.1.2** int immustats\_entry::fetch\_tlbhit

**5.79.1.3** int immustats\_entry::fetch\_tlbmiss

The documentation for this struct was generated from the following file:

- [cpu/common/stats.h](#)

## 5.80 INFOHEADER Struct Reference

### Data Fields

- unsigned int [size](#)
- int [width](#)
- int [height](#)
- unsigned short int [planes](#)
- unsigned short int [bits](#)
- unsigned int [compression](#)
- unsigned int [imagesize](#)
- int [xresolution](#)
- int [yresolution](#)
- unsigned int [ncolours](#)
- unsigned int [importantcolours](#)

### 5.80.1 Field Documentation

**5.80.1.1 unsigned short int INFOHEADER::bits**

**5.80.1.2 unsigned int INFOHEADER::compression**

**5.80.1.3 int INFOHEADER::height**

**5.80.1.4 unsigned int INFOHEADER::imagesize**

**5.80.1.5 unsigned int INFOHEADER::importantcolours**

**5.80.1.6 unsigned int INFOHEADER::ncolours**

**5.80.1.7 unsigned short int INFOHEADER::planes**

**5.80.1.8 unsigned int INFOHEADER::size**

**5.80.1.9 int INFOHEADER::width**

**5.80.1.10 int INFOHEADER::xresolution**

**5.80.1.11 int INFOHEADER::yresolution**

The documentation for this struct was generated from the following file:

- [peripheral/vga.c](#)

## 5.81 iqueue\_entry Struct Reference

```
#include <abstract.h>
```

### Data Fields

- int [insn\\_index](#)
- uint32\_t [insn](#)
- oraddr\_t [insn\\_addr](#)

### 5.81.1 Detailed Description

Instruction queue

### 5.81.2 Field Documentation

#### 5.81.2.1 uint32\_t iqueue\_entry::insn

#### 5.81.2.2 oraddr\_t iqueue\_entry::insn\_addr

#### 5.81.2.3 int iqueue\_entry::insn\_index

The documentation for this struct was generated from the following file:

- [cpu/common/abstract.h](#)

## 5.82 jtr\_chain\_message Struct Reference

```
#include <gdb.h>
```

### Data Fields

- [uint32\\_t command](#)
- [uint32\\_t length](#)
- [uint32\\_t chain](#)

### 5.82.1 Field Documentation

#### 5.82.1.1 uint32\_t jtr\_chain\_message::chain

#### 5.82.1.2 uint32\_t jtr\_chain\_message::command

#### 5.82.1.3 uint32\_t jtr\_chain\_message::length

The documentation for this struct was generated from the following file:

- [debug/gdb.h](#)

## 5.83 jtr\_chain\_response Struct Reference

```
#include <gdb.h>
```

### Data Fields

- [int32\\_t status](#)

### 5.83.1 Field Documentation

#### 5.83.1.1 int32\_t jtr\_chain\_response::status

The documentation for this struct was generated from the following file:

- [debug/gdb.h](#)

## 5.84 `jtr_failure_response` Struct Reference

```
#include <gdb.h>
```

### Data Fields

- `int32_t status`

### 5.84.1 Field Documentation

#### 5.84.1.1 `int32_t jtr_failure_response::status`

The documentation for this struct was generated from the following file:

- `debug/gdb.h`

## 5.85 jtr\_read\_block\_message Struct Reference

```
#include <gdb.h>
```

### Data Fields

- uint32\_t [command](#)
- uint32\_t [length](#)
- uint32\_t [address](#)
- int32\_t [num\\_regs](#)

### 5.85.1 Field Documentation

5.85.1.1 uint32\_t jtr\_read\_block\_message::address

5.85.1.2 uint32\_t jtr\_read\_block\_message::command

5.85.1.3 uint32\_t jtr\_read\_block\_message::length

5.85.1.4 int32\_t jtr\_read\_block\_message::num\_regs

The documentation for this struct was generated from the following file:

- [debug/gdb.h](#)



## 5.86 jtr\_read\_block\_response Struct Reference

```
#include <gdb.h>
```

### Data Fields

- [int32\\_t status](#)
- [int32\\_t num\\_regs](#)
- [uint32\\_t data](#) [1]

### 5.86.1 Field Documentation

**5.86.1.1** [uint32\\_t jtr\\_read\\_block\\_response::data\[1\]](#)

**5.86.1.2** [int32\\_t jtr\\_read\\_block\\_response::num\\_regs](#)

**5.86.1.3** [int32\\_t jtr\\_read\\_block\\_response::status](#)

The documentation for this struct was generated from the following file:

- [debug/gdb.h](#)

## 5.87 jtr\_read\_message Struct Reference

```
#include <gdb.h>
```

### Data Fields

- [uint32\\_t command](#)
- [uint32\\_t length](#)
- [uint32\\_t address](#)

### 5.87.1 Field Documentation

**5.87.1.1** [uint32\\_t jtr\\_read\\_message::address](#)

**5.87.1.2** [uint32\\_t jtr\\_read\\_message::command](#)

**5.87.1.3** [uint32\\_t jtr\\_read\\_message::length](#)

The documentation for this struct was generated from the following file:

- [debug/gdb.h](#)

## 5.88 jtr\_read\_response Struct Reference

```
#include <gdb.h>
```

### Data Fields

- [int32\\_t status](#)
- [uint32\\_t data\\_h](#)
- [uint32\\_t data\\_l](#)

### 5.88.1 Field Documentation

**5.88.1.1** [uint32\\_t jtr\\_read\\_response::data\\_h](#)

**5.88.1.2** [uint32\\_t jtr\\_read\\_response::data\\_l](#)

**5.88.1.3** [int32\\_t jtr\\_read\\_response::status](#)

The documentation for this struct was generated from the following file:

- [debug/gdb.h](#)

## 5.89 jtr\_write\_block\_message Struct Reference

```
#include <gdb.h>
```

### Data Fields

- [uint32\\_t command](#)
- [uint32\\_t length](#)
- [uint32\\_t address](#)
- [int32\\_t num\\_regs](#)
- [uint32\\_t data \[1\]](#)

### 5.89.1 Field Documentation

**5.89.1.1** [uint32\\_t jtr\\_write\\_block\\_message::address](#)

**5.89.1.2** [uint32\\_t jtr\\_write\\_block\\_message::command](#)

**5.89.1.3** [uint32\\_t jtr\\_write\\_block\\_message::data\[1\]](#)

**5.89.1.4** [uint32\\_t jtr\\_write\\_block\\_message::length](#)

**5.89.1.5** [int32\\_t jtr\\_write\\_block\\_message::num\\_regs](#)

The documentation for this struct was generated from the following file:

- [debug/gdb.h](#)

## 5.90 jtr\_write\_block\_response Struct Reference

```
#include <gdb.h>
```

### Data Fields

- [int32\\_t status](#)

### 5.90.1 Field Documentation

#### 5.90.1.1 int32\_t jtr\_write\_block\_response::status

The documentation for this struct was generated from the following file:

- [debug/gdb.h](#)

## 5.91 jtr\_write\_message Struct Reference

```
#include <gdb.h>
```

### Data Fields

- [uint32\\_t command](#)
- [uint32\\_t length](#)
- [uint32\\_t address](#)
- [uint32\\_t data\\_h](#)
- [uint32\\_t data\\_l](#)

### 5.91.1 Field Documentation

**5.91.1.1** `uint32_t jtr_write_message::address`

**5.91.1.2** `uint32_t jtr_write_message::command`

**5.91.1.3** `uint32_t jtr_write_message::data_h`

**5.91.1.4** `uint32_t jtr_write_message::data_l`

**5.91.1.5** `uint32_t jtr_write_message::length`

The documentation for this struct was generated from the following file:

- [debug/gdb.h](#)

## 5.92 jtr\_write\_response Struct Reference

```
#include <gdb.h>
```

### Data Fields

- [int32\\_t status](#)

### 5.92.1 Field Documentation

#### 5.92.1.1 int32\_t jtr\_write\_response::status

The documentation for this struct was generated from the following file:

- [debug/gdb.h](#)

## 5.93 kbd\_state Struct Reference

### Data Fields

- uint8\_t [buf](#) [KBD\_MAX\_BUF]
- unsigned long [buf\\_count](#)
- unsigned long [buf\\_head](#)
- unsigned long [buf\\_tail](#)
- FILE \* [rxfs](#)
- int [ccmd](#)
- uint8\_t [kcmd](#)
- uint8\_t [ccmdbyte](#)
- unsigned long [kresp](#)
- long [slowdown](#)
- int [enabled](#)
- int [irq](#)
- oraddr\_t [baseaddr](#)
- char \* [rxfile](#)

### 5.93.1 Field Documentation

5.93.1.1 [oraddr\\_t kbd\\_state::baseaddr](#)

5.93.1.2 [uint8\\_t kbd\\_state::buf\[KBD\\_MAX\\_BUF\]](#)

5.93.1.3 [unsigned long kbd\\_state::buf\\_count](#)

5.93.1.4 [unsigned long kbd\\_state::buf\\_head](#)

5.93.1.5 [unsigned long kbd\\_state::buf\\_tail](#)

5.93.1.6 [int kbd\\_state::ccmd](#)

5.93.1.7 [uint8\\_t kbd\\_state::ccmdbyte](#)

5.93.1.8 [int kbd\\_state::enabled](#)

5.93.1.9 [int kbd\\_state::irq](#)

5.93.1.10 [uint8\\_t kbd\\_state::kcmd](#)

5.93.1.11 [unsigned long kbd\\_state::kresp](#)

5.93.1.12 [char\\* kbd\\_state::rxfile](#)

5.93.1.13 [FILE\\* kbd\\_state::rxfs](#)

5.93.1.14 [long kbd\\_state::slowdown](#)

The documentation for this struct was generated from the following file:

- [peripheral/ps2kbd.c](#)



## 5.94 label\_entry Struct Reference

```
#include <labels.h>
```

Collaboration diagram for label\_entry:

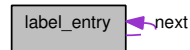

### Data Fields

- char \* [name](#)
- [oraddr\\_t](#) [addr](#)
- struct [label\\_entry](#) \* [next](#)

### 5.94.1 Detailed Description

Structure for holding one label per particular memory location

### 5.94.2 Field Documentation

**5.94.2.1** [oraddr\\_t](#) [label\\_entry::addr](#)

**5.94.2.2** [char\\*](#) [label\\_entry::name](#)

**5.94.2.3** [struct label\\_entry\\*](#) [label\\_entry::next](#) [read]

The documentation for this struct was generated from the following file:

- [cpu/common/labels.h](#)

## 5.95 mc Struct Reference

Collaboration diagram for mc:

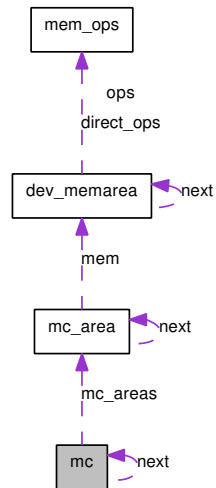

### Data Fields

- `uint32_t` `csr`
- `uint32_t` `poc`
- `uint32_t` `ba_mask`
- `uint32_t` `csc` [N\_CE]
- `uint32_t` `tms` [N\_CE]
- `oraddr_t` `baseaddr`
- `int` `enabled`
- `int` `index`
- `struct mc_area *` `mc_areas`
- `struct mc *` `next`

## 5.95.1 Field Documentation

5.95.1.1 `uint32_t mc::ba_mask`

5.95.1.2 `oraddr_t mc::baseaddr`

5.95.1.3 `uint32_t mc::csc[N_CE]`

5.95.1.4 `uint32_t mc::csr`

5.95.1.5 `int mc::enabled`

5.95.1.6 `int mc::index`

5.95.1.7 `struct mc_area* mc::mc_areas` [read]

5.95.1.8 `struct mc* mc::next` [read]

5.95.1.9 `uint32_t mc::poc`

5.95.1.10 `uint32_t mc::tms[N_CE]`

The documentation for this struct was generated from the following file:

- [peripheral/mc.c](#)

## 5.96 mc\_area Struct Reference

Collaboration diagram for mc\_area:

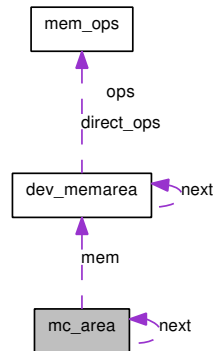

### Data Fields

- struct [dev\\_memarea](#) \* [mem](#)
- unsigned int [cs](#)
- int [mc](#)
- struct [mc\\_area](#) \* [next](#)

### 5.96.1 Field Documentation

**5.96.1.1** unsigned int [mc\\_area::cs](#)

**5.96.1.2** int [mc\\_area::mc](#)

**5.96.1.3** struct [dev\\_memarea](#)\* [mc\\_area::mem](#) [read]

**5.96.1.4** struct [mc\\_area](#)\* [mc\\_area::next](#) [read]

The documentation for this struct was generated from the following file:

- [peripheral/mc.c](#)

## 5.97 mem\_config Struct Reference

### Public Types

- enum { [MT\\_UNKNOWN](#), [MT\\_PATTERN](#), [MT\\_RANDOM](#) }

### Data Fields

- int [ce](#)
- int [mc](#)
- [oraddr\\_t](#) [baseaddr](#)
- unsigned int [size](#)
- char \* [name](#)
- char \* [log](#)
- int [delayr](#)
- int [delayw](#)
- void \* [mem](#)
- int [pattern](#)
- int [random\\_seed](#)
- enum [mem\\_config::](#) { ... } [type](#)

### 5.97.1 Member Enumeration Documentation

#### 5.97.1.1 anonymous enum

**Enumerator:**

*MT\_UNKNOWN*

*MT\_PATTERN*

*MT\_RANDOM*

## 5.97.2 Field Documentation

5.97.2.1 `oraddr_t mem_config::baseaddr`

5.97.2.2 `int mem_config::ce`

5.97.2.3 `int mem_config::delayr`

5.97.2.4 `int mem_config::delayw`

5.97.2.5 `char* mem_config::log`

5.97.2.6 `int mem_config::mc`

5.97.2.7 `void* mem_config::mem`

5.97.2.8 `char* mem_config::name`

5.97.2.9 `int mem_config::pattern`

5.97.2.10 `int mem_config::random_seed`

5.97.2.11 `unsigned int mem_config::size`

5.97.2.12 `enum { ... } mem_config::type`

The documentation for this struct was generated from the following file:

- [peripheral/memory.c](#)

## 5.98 mem\_ops Struct Reference

```
#include <abstract.h>
```

### Data Fields

- uint32\_t(\* [readfunc32](#))(oraddr\_t, void \*)
- uint16\_t(\* [readfunc16](#))(oraddr\_t, void \*)
- uint8\_t(\* [readfunc8](#))(oraddr\_t, void \*)
- void \* [read\\_dat8](#)
- void \* [read\\_dat16](#)
- void \* [read\\_dat32](#)
- void(\* [writefunc32](#))(oraddr\_t, uint32\_t, void \*)
- void(\* [writefunc16](#))(oraddr\_t, uint16\_t, void \*)
- void(\* [writefunc8](#))(oraddr\_t, uint8\_t, void \*)
- void \* [write\\_dat8](#)
- void \* [write\\_dat16](#)
- void \* [write\\_dat32](#)
- void(\* [writeprog32](#))(oraddr\_t, uint32\_t, void \*)
- void(\* [writeprog8](#))(oraddr\_t, uint8\_t, void \*)
- void \* [writeprog32\\_dat](#)
- void \* [writeprog8\\_dat](#)
- int [delayr](#)
- int [delayw](#)
- const char \* [log](#)

### 5.98.1 Detailed Description

All the memory operations possible

## 5.98.2 Field Documentation

5.98.2.1 `int mem_ops::delayr`

5.98.2.2 `int mem_ops::delayw`

5.98.2.3 `const char* mem_ops::log`

5.98.2.4 `void* mem_ops::read_dat16`

5.98.2.5 `void* mem_ops::read_dat32`

5.98.2.6 `void* mem_ops::read_dat8`

5.98.2.7 `uint16_t(* mem_ops::readfunc16)(oraddr_t, void *)`

5.98.2.8 `uint32_t(* mem_ops::readfunc32)(oraddr_t, void *)`

5.98.2.9 `uint8_t(* mem_ops::readfunc8)(oraddr_t, void *)`

5.98.2.10 `void* mem_ops::write_dat16`

5.98.2.11 `void* mem_ops::write_dat32`

5.98.2.12 `void* mem_ops::write_dat8`

5.98.2.13 `void(* mem_ops::writefunc16)(oraddr_t, uint16_t, void *)`

5.98.2.14 `void(* mem_ops::writefunc32)(oraddr_t, uint32_t, void *)`

5.98.2.15 `void(* mem_ops::writefunc8)(oraddr_t, uint8_t, void *)`

5.98.2.16 `void(* mem_ops::writeprog32)(oraddr_t, uint32_t, void *)`

5.98.2.17 `void* mem_ops::writeprog32_dat`

5.98.2.18 `void(* mem_ops::writeprog8)(oraddr_t, uint8_t, void *)`

5.98.2.19 `void* mem_ops::writeprog8_dat`

The documentation for this struct was generated from the following file:

- [cpu/common/abstract.h](#)



## 5.99 memory\_hash Struct Reference

Collaboration diagram for memory\_hash:

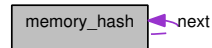

### Data Fields

- struct [memory\\_hash](#) \* [next](#)
- [oraddr\\_t](#) [addr](#)
- unsigned long [cnt](#) [3]

### 5.99.1 Detailed Description

Hash table data structure

### 5.99.2 Field Documentation

#### 5.99.2.1 [oraddr\\_t](#) [memory\\_hash::addr](#)

#### 5.99.2.2 unsigned long [memory\\_hash::cnt](#)[3]

#### 5.99.2.3 struct [memory\\_hash](#)\* [memory\\_hash::next](#) [read]

The documentation for this struct was generated from the following file:

- [mprofiler.c](#)

## 5.100 mp\_entry Struct Reference

Collaboration diagram for mp\_entry:



### Data Fields

- enum [mp\\_type](#) type
- unsigned long int [addr](#)
- unsigned long int [instr](#)
- struct [mp\\_entry](#) \* [next](#)

### 5.100.1 Detailed Description

Data structure for a matchpoint hash table entry

### 5.100.2 Field Documentation

#### 5.100.2.1 unsigned long int mp\_entry::addr

Address with the matchpoint

#### 5.100.2.2 unsigned long int mp\_entry::instr

Substituted instruction

#### 5.100.2.3 struct mp\_entry\* mp\_entry::next [read]

Next entry with this hash

#### 5.100.2.4 enum mp\_type mp\_entry::type

Type of matchpoint

The documentation for this struct was generated from the following file:

- [debug/rsp-server.c](#)

## 5.101 mprofentry\_struct Struct Reference

```
#include <profile.h>
```

### Data Fields

- [oraddr\\_t addr](#)
- unsigned char [type](#)

### 5.101.1 Field Documentation

#### 5.101.1.1 oraddr\_t mprofentry\_struct::addr

#### 5.101.1.2 unsigned char mprofentry\_struct::type

The documentation for this struct was generated from the following file:

- [support/profile.h](#)

## 5.102 mstats\_entry Struct Reference

```
#include <stats.h>
```

Collaboration diagram for mstats\_entry:

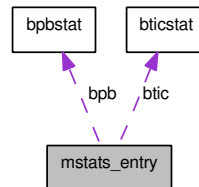

### Data Fields

- int [byteadd](#)
- int [bf](#) [2][2]
- int [bnf](#) [2][2]
- struct [bpbstat](#) [bpb](#)
- struct [bticstat](#) [btic](#)

### 5.102.1 Field Documentation

**5.102.1.1** int [mstats\\_entry::bf](#)[2][2]

**5.102.1.2** int [mstats\\_entry::bnf](#)[2][2]

**5.102.1.3** struct [bpbstat](#) [mstats\\_entry::bpb](#) [read]

**5.102.1.4** struct [bticstat](#) [mstats\\_entry::btic](#) [read]

**5.102.1.5** int [mstats\\_entry::byteadd](#)

The documentation for this struct was generated from the following file:

- [cpu/common/stats.h](#)

## 5.103 op\_queue Struct Reference

```
#include <dyn32-defs.h>
```

Collaboration diagram for op\_queue:

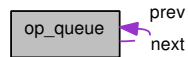

### Data Fields

- unsigned int [num\\_ops](#)
- unsigned int [ops\\_len](#)
- unsigned int \* [ops](#)
- unsigned int [num\\_ops\\_param](#)
- unsigned int [ops\\_param\\_len](#)
- unsigned int \* [ops\\_param](#)
- unsigned int [jump\\_local](#)
- [oraddr\\_t](#) [jump\\_local\\_loc](#)
- unsigned int [not\\_jump\\_loc](#)
- int [xref](#)
- [oraddr\\_t](#) [insn\\_addr](#)
- unsigned int [reg\\_t](#) [3]
- unsigned int [tflags](#) [3]
- int [insn\\_index](#)
- unsigned int [param\\_type](#) [5]
- [orreg\\_t](#) [param](#) [5]
- unsigned int [param\\_num](#)
- uint32\_t [insn](#)
- struct [op\\_queue](#) \* [prev](#)
- struct [op\\_queue](#) \* [next](#)

### 5.103.1 Field Documentation

- 5.103.1.1 `uint32_t op_queue::insn`
- 5.103.1.2 `oraddr_t op_queue::insn_addr`
- 5.103.1.3 `int op_queue::insn_index`
- 5.103.1.4 `unsigned int op_queue::jump_local`
- 5.103.1.5 `oraddr_t op_queue::jump_local_loc`
- 5.103.1.6 `struct op_queue* op_queue::next` [read]
- 5.103.1.7 `unsigned int op_queue::not_jump_loc`
- 5.103.1.8 `unsigned int op_queue::num_ops`
- 5.103.1.9 `unsigned int op_queue::num_ops_param`
- 5.103.1.10 `unsigned int* op_queue::ops`
- 5.103.1.11 `unsigned int op_queue::ops_len`
- 5.103.1.12 `unsigned int* op_queue::ops_param`
- 5.103.1.13 `unsigned int op_queue::ops_param_len`
- 5.103.1.14 `orreg_t op_queue::param[5]`
- 5.103.1.15 `unsigned int op_queue::param_num`
- 5.103.1.16 `unsigned int op_queue::param_type[5]`
- 5.103.1.17 `struct op_queue* op_queue::prev` [read]
- 5.103.1.18 `unsigned int op_queue::reg_t[3]`
- 5.103.1.19 `unsigned int op_queue::tflags[3]`
- 5.103.1.20 `int op_queue::xref`

The documentation for this struct was generated from the following file:

- [cpu/or32/dyn32-defs.h](#)

## 5.104 param\_val Union Reference

```
#include <sim-config.h>
```

### Data Fields

- char \* [str\\_val](#)
- int [int\\_val](#)
- long long int [longlong\\_val](#)
- [oraddr\\_t](#) [addr\\_val](#)

### 5.104.1 Detailed Description

Union of all possible paramter values

### 5.104.2 Field Documentation

#### 5.104.2.1 [oraddr\\_t](#) [param\\_val::addr\\_val](#)

#### 5.104.2.2 int [param\\_val::int\\_val](#)

#### 5.104.2.3 long long int [param\\_val::longlong\\_val](#)

#### 5.104.2.4 char\* [param\\_val::str\\_val](#)

The documentation for this union was generated from the following file:

- [sim-config.h](#)

## 5.105 raw\_stats Struct Reference

```
#include <stats.h>
```

### Data Fields

- int [reg](#) [64]
- int [range](#) [RAW\_RANGE]

### 5.105.1 Field Documentation

**5.105.1.1** int `raw_stats::range`[RAW\_RANGE]

**5.105.1.2** int `raw_stats::reg`[64]

The documentation for this struct was generated from the following file:

- `cpu/common/stats.h`



## 5.106 reloc Struct Reference

```
#include <dyngen.h>
```

### Data Fields

- unsigned int [func\\_offset](#)
- unsigned int [addend](#)
- int [type](#)
- const char \* [name](#)

### 5.106.1 Field Documentation

**5.106.1.1** unsigned int `reloc::addend`

**5.106.1.2** unsigned int `reloc::func_offset`

**5.106.1.3** const char\* `reloc::name`

**5.106.1.4** int `reloc::type`

The documentation for this struct was generated from the following file:

- [cpu/or32/dyngen.h](#)

## 5.107 `rsp_buf` Struct Reference

### Data Fields

- char `data` [GDB\_BUF\_MAX]
- int `len`

#### 5.107.1 Detailed Description

Data structure for RSP buffers. Can't be null terminated, since it may include zero bytes

#### 5.107.2 Field Documentation

**5.107.2.1** char `rsp_buf::data`[GDB\_BUF\_MAX]

**5.107.2.2** int `rsp_buf::len`

The documentation for this struct was generated from the following file:

- [debug/rsp-server.c](#)

## 5.108 runtime Struct Reference

```
#include <sim-config.h>
```

### Data Fields

- struct {
  - FILE \* [fprof](#)
  - FILE \* [fmprof](#)
  - FILE \* [fexe\\_log](#)
  - FILE \* [fout](#)
  - char \* [filename](#)
  - int [iprompt](#)
  - int [iprompt\\_run](#)
  - long long [cycles](#)
  - long long int [end\\_cycles](#)
  - double [time\\_point](#)
  - unsigned long int [ext\\_int\\_set](#)
  - unsigned long int [ext\\_int\\_clr](#)
  - int [mem\\_cycles](#)
  - int [loadcycles](#)
  - int [storecycles](#)
  - long long [reset\\_cycles](#)
  - int [hush](#)
- } [sim](#)
- struct {
  - long long [instructions](#)
  - long long [reset\\_instructions](#)
  - int [stalled](#)
  - int [hazardwait](#)
  - int [supercycles](#)
- } [cpu](#)
- struct {
  - int [enabled](#)
  - FILE \* [vapi\\_file](#)
  - int [server\\_port](#)
- } [vapi](#)
- struct {
  - int [mdelay](#) [4]
  - double [cycle\\_duration](#)
- } [cuc](#)

### 5.108.1 Detailed Description

Data structure for run time data



## 5.108.2 Field Documentation

- 5.108.2.1 struct { ... } runtime::cpu
- 5.108.2.2 struct { ... } runtime::cuc
- 5.108.2.3 double runtime::cycle\_duration
- 5.108.2.4 long long runtime::cycles
- 5.108.2.5 int runtime::enabled
- 5.108.2.6 long long int runtime::end\_cycles
- 5.108.2.7 unsigned long int runtime::ext\_int\_clr
- 5.108.2.8 unsigned long int runtime::ext\_int\_set
- 5.108.2.9 FILE\* runtime::fexe\_log
- 5.108.2.10 char\* runtime::filename
- 5.108.2.11 FILE\* runtime::fmprof
- 5.108.2.12 FILE\* runtime::fout
- 5.108.2.13 FILE\* runtime::fprof
- 5.108.2.14 int runtime::hazardwait
- 5.108.2.15 int runtime::hush
- 5.108.2.16 long long runtime::instructions
- 5.108.2.17 int runtime::iprompt
- 5.108.2.18 int runtime::iprompt\_run
- 5.108.2.19 int runtime::loadcycles
- 5.108.2.20 int runtime::mdelay[4]
- 5.108.2.21 int runtime::mem\_cycles
- 5.108.2.22 long long runtime::reset\_cycles
- 5.108.2.23 long long runtime::reset\_instructions
- 5.108.2.24 int runtime::server\_port
- 5.108.2.25 struct { ... } runtime::sim
- 5.108.2.26 int runtime::stalled
- 5.108.2.27 int runtime::storecycles

---

Generated on Tue Feb 24 14:27:06 2009 for O1KSim: The OpenRISC 1000 Architectural Simulator by Doxygen

5.108.2.28 int runtime::supercycles

5.108.2.29 double runtime::time\_point

5.108.2.30 struct { ... } runtime::vapi

- [sim-config.h](#)

## 5.109 sched\_entry Struct Reference

```
#include <sched.h>
```

Collaboration diagram for sched\_entry:

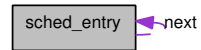

### Data Fields

- `int32_t` [time](#)
- `void *` [param](#)
- `void(* func)(void *)`
- `struct sched_entry *` [next](#)

### 5.109.1 Detailed Description

Structure for holding one job entry

### 5.109.2 Field Documentation

**5.109.2.1** `void(* sched_entry::func)(void *)`

**5.109.2.2** `struct sched_entry* sched_entry::next` [read]

**5.109.2.3** `void* sched_entry::param`

**5.109.2.4** `int32_t sched_entry::time`

The documentation for this struct was generated from the following file:

- [support/sched.h](#)

## 5.110 scheduler\_struct Struct Reference

```
#include <sched.h>
```

Collaboration diagram for scheduler\_struct:

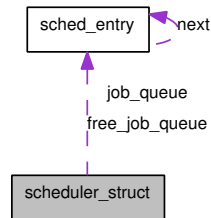

### Data Fields

- struct `sched_entry` \* `free_job_queue`
- struct `sched_entry` \* `job_queue`

### 5.110.1 Detailed Description

Heap of jobs

### 5.110.2 Field Documentation

**5.110.2.1** struct `sched_entry`\* `scheduler_struct::free_job_queue` [read]

**5.110.2.2** struct `sched_entry`\* `scheduler_struct::job_queue` [read]

The documentation for this struct was generated from the following file:

- support/[sched.h](#)



## 5.111 `sim_command` Struct Reference

### Data Fields

- `const char * name`
- `int(* cmd_handle)(int argc, char **argv)`

### 5.111.1 Field Documentation

**5.111.1.1** `int(* sim_command::cmd_handle)(int argc, char **argv)`

**5.111.1.2** `const char* sim_command::name`

The documentation for this struct was generated from the following file:

- `sim-cmd.c`

## 5.112 `sim_reset_hook` Struct Reference

Collaboration diagram for `sim_reset_hook`:

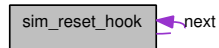

### Data Fields

- `void * dat`
- `void(* reset_hook)(void *)`
- `struct sim_reset_hook * next`

#### 5.112.1 Detailed Description

Struct for list of reset hooks

#### 5.112.2 Field Documentation

**5.112.2.1** `void* sim_reset_hook::dat`

**5.112.2.2** `struct sim_reset_hook* sim_reset_hook::next` [read]

**5.112.2.3** `void(* sim_reset_hook::reset_hook)(void *)`

The documentation for this struct was generated from the following file:

- [toplevel-support.c](#)

## 5.113 sim\_stat Struct Reference

Collaboration diagram for sim\_stat:

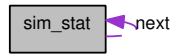

### Data Fields

- void(\* [stat\\_func](#) )(void \*[dat](#))
- void \* [dat](#)
- struct [sim\\_stat](#) \* [next](#)

### 5.113.1 Field Documentation

**5.113.1.1 void\* [sim\\_stat::dat](#)**

**5.113.1.2 struct [sim\\_stat](#)\* [sim\\_stat::next](#) [read]**

**5.113.1.3 void(\* [sim\\_stat::stat\\_func](#))(void \*[dat](#))**

The documentation for this struct was generated from the following file:

- [sim-cmd.c](#)

## 5.114 spr\_bit\_def Struct Reference

### Data Fields

- `const char * name`
- `uorreg_t mask`

### 5.114.1 Field Documentation

#### 5.114.1.1 `uorreg_t spr_bit_def::mask`

#### 5.114.1.2 `const char* spr_bit_def::name`

The documentation for this struct was generated from the following file:

- `cpu/or1k/spr-dump.c`

## 5.115 spr\_def Struct Reference

Collaboration diagram for spr\_def:

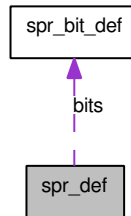

### Data Fields

- [uint16\\_t from\\_spr](#)
- [uint16\\_t to\\_spr](#)
- [const char \\* name](#)
- [struct spr\\_bit\\_def \\* bits](#)

### 5.115.1 Field Documentation

**5.115.1.1** [struct spr\\_bit\\_def\\* spr\\_def::bits](#) [read]

**5.115.1.2** [uint16\\_t spr\\_def::from\\_spr](#)

**5.115.1.3** [const char\\* spr\\_def::name](#)

**5.115.1.4** [uint16\\_t spr\\_def::to\\_spr](#)

The documentation for this struct was generated from the following file:

- [cpu/or1k/spr-dump.c](#)

## 5.116 sstats\_entry Struct Reference

### Data Fields

- int [insn](#)
- int [cnt\\_dynamic](#)

### 5.116.1 Field Documentation

#### 5.116.1.1 int sstats\_entry::cnt\_dynamic

#### 5.116.1.2 int sstats\_entry::insn

The documentation for this struct was generated from the following file:

- [cpu/common/stats.c](#)

## 5.117 `stack_struct` Struct Reference

### Data Fields

- unsigned int [addr](#)
- unsigned int [cycles](#)
- unsigned int [raddr](#)
- char [name](#) [33]

### 5.117.1 Detailed Description

Data structure representing information about a stack frame

### 5.117.2 Field Documentation

#### 5.117.2.1 unsigned int `stack_struct::addr`

Function address

#### 5.117.2.2 unsigned int `stack_struct::cycles`

Cycles of func start; subfuncs added later

#### 5.117.2.3 char `stack_struct::name[33]`

Name of the function

#### 5.117.2.4 unsigned int `stack_struct::raddr`

Return address

The documentation for this struct was generated from the following file:

- [profiler.c](#)

## 5.118 tcp\_channel Struct Reference

Collaboration diagram for tcp\_channel:

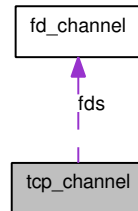

### Data Fields

- struct [fd\\_channel](#) `fds`
- int [socket\\_fd](#)
- int [port\\_number](#)
- int [connected](#)
- int [nonblocking](#)

### 5.118.1 Detailed Description

Structure to represent a TCP/IP [channel](#)

### 5.118.2 Field Documentation

**5.118.2.1** int `tcp_channel::connected`

**5.118.2.2** struct `fd_channel` `tcp_channel::fds` [`read`]

**5.118.2.3** int `tcp_channel::nonblocking`

**5.118.2.4** int `tcp_channel::port_number`

**5.118.2.5** int `tcp_channel::socket_fd`

The documentation for this struct was generated from the following file:

- [peripheral/channels/tcp.c](#)



## 5.119 tty\_channel Struct Reference

Collaboration diagram for tty\_channel:

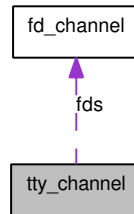

### Data Fields

- struct [fd\\_channel](#) `fds`

### 5.119.1 Detailed Description

Data structure representing a TTY [channel](#)

### 5.119.2 Field Documentation

#### 5.119.2.1 struct `fd_channel` `tty_channel::fds` [read]

The documentation for this struct was generated from the following file:

- [peripheral/channels/tty.c](#)

## 5.120 vapi\_handler Struct Reference

Collaboration diagram for vapi\_handler:

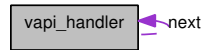

### Data Fields

- int [fd](#)
- unsigned long [base\\_id](#)
- unsigned long [num\\_ids](#)
- void(\* [read\\_func](#))(unsigned long, unsigned long, void \*)
- void \* [priv\\_dat](#)
- struct [vapi\\_handler](#) \* [next](#)
- int [temp](#)

### 5.120.1 Field Documentation

**5.120.1.1** unsigned long `vapi_handler::base_id`

**5.120.1.2** int `vapi_handler::fd`

**5.120.1.3** struct `vapi_handler*` `vapi_handler::next` [`read`]

**5.120.1.4** unsigned long `vapi_handler::num_ids`

**5.120.1.5** void\* `vapi_handler::priv_dat`

**5.120.1.6** void(\* `vapi_handler::read_func`)(unsigned long, unsigned long, void \*)

**5.120.1.7** int `vapi_handler::temp`

The documentation for this struct was generated from the following file:

- [vapi/vapi.c](#)

## 5.121 vga\_state Struct Reference

### Data Fields

- int [enabled](#)
- int [pics](#)
- unsigned long [ctrl](#)
- unsigned long [stat](#)
- unsigned long [htim](#)
- unsigned long [vtim](#)
- int [vbindx](#)
- unsigned long [vbar](#) [2]
- unsigned [hlen](#)
- unsigned [vlen](#)
- int [pindex](#)
- unsigned long [palette](#) [2][256]
- [oraddr\\_t](#) [baseaddr](#)
- int [refresh\\_rate](#)
- int [irq](#)
- char \* [filename](#)

### 5.121.1 Field Documentation

- 5.121.1.1 `oraddr_t vga_state::baseaddr`
- 5.121.1.2 `unsigned long vga_state::ctrl`
- 5.121.1.3 `int vga_state::enabled`
- 5.121.1.4 `char* vga_state::filename`
- 5.121.1.5 `unsigned vga_state::hlen`
- 5.121.1.6 `unsigned long vga_state::htim`
- 5.121.1.7 `int vga_state::irq`
- 5.121.1.8 `unsigned long vga_state::palette[2][256]`
- 5.121.1.9 `int vga_state::pics`
- 5.121.1.10 `int vga_state::pindex`
- 5.121.1.11 `int vga_state::refresh_rate`
- 5.121.1.12 `unsigned long vga_state::stat`
- 5.121.1.13 `unsigned long vga_state::vbar[2]`
- 5.121.1.14 `int vga_state::vbindx`
- 5.121.1.15 `unsigned vga_state::vlen`
- 5.121.1.16 `unsigned long vga_state::vtim`

The documentation for this struct was generated from the following file:

- [peripheral/vga.c](#)

## 5.122 xterm\_channel Struct Reference

Collaboration diagram for xterm\_channel:

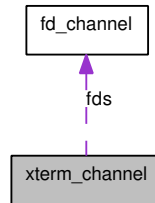

### Data Fields

- struct [fd\\_channel](#) `fds`
- int `pid`
- char \*\* `argv`

### 5.122.1 Detailed Description

Data structure to represent the connection to the xterm

### 5.122.2 Field Documentation

**5.122.2.1** char\*\* `xterm_channel::argv`

**5.122.2.2** struct [fd\\_channel](#) `xterm_channel::fds` [read]

**5.122.2.3** int `xterm_channel::pid`

The documentation for this struct was generated from the following file:

- `peripheral/channels/xterm.c`



# Chapter 6

## File Documentation

### 6.1 bpb/branch-predict.c File Reference

```
#include "config.h"  
#include "port.h"  
#include <stdio.h>  
#include <errno.h>  
#include <stdarg.h>  
#include "sim-config.h"  
#include "arch.h"  
#include "stats.h"
```

Include dependency graph for branch-predict.c:

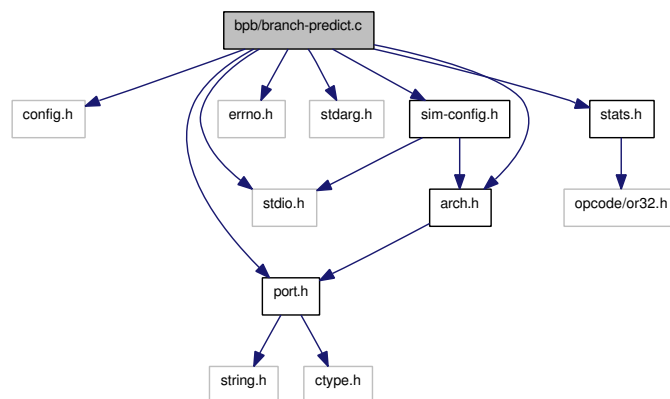

### Data Structures

- struct `bpb_entry`
- struct `bpic_entry`

## Defines

- #define `BPB_LEN` 64
- #define `BPB_WAYS` 1
- #define `BPB_PSTATES` 2
- #define `BPB_USTATES` 2
- #define `BTIC_LEN` 128
- #define `BTIC_WAYS` 2
- #define `BTIC_USTATES` 2
- #define `BTIC_BLOCKSIZE` 4

## Functions

- void `bpb_info` ()
- void `bpb_update` (`oraddr_t` addr, int taken)
- void `btic_info` ()
- void `btic_update` (`oraddr_t` targetaddr)
- static void `bpb_enabled` (union `param_val` val, void \*dat)
- static void `bpb_btic` (union `param_val` val, void \*dat)
- static void `bpb_sbp_bnf_fwd` (union `param_val` val, void \*dat)
- static void `bpb_sbp_bf_fwd` (union `param_val` val, void \*dat)
- static void `bpb_missdelay` (union `param_val` val, void \*dat)
- static void `bpb_hitdelay` (union `param_val` val, void \*dat)
- void `reg_bpb_sec` ()

## Variables

- struct `bpb_entry` `bpb` [`BPB_LEN`]
- struct `btic_entry` `btic` [`BTIC_LEN`]





## 6.1.1 Define Documentation

6.1.1.1 `#define BPB_LEN 64`

6.1.1.2 `#define BPB_PSTATES 2`

6.1.1.3 `#define BPB_USTATES 2`

6.1.1.4 `#define BPB_WAYS 1`

6.1.1.5 `#define BTIC_BLOCKSIZE 4`

6.1.1.6 `#define BTIC_LEN 128`

6.1.1.7 `#define BTIC_USTATES 2`

6.1.1.8 `#define BTIC_WAYS 2`

## 6.1.2 Function Documentation

6.1.2.1 `static void bpb_btict (union param_val val, void * dat) [static]`

6.1.2.2 `static void bpb_enabled (union param_val val, void * dat) [static]`

6.1.2.3 `static void bpb_hitdelay (union param_val val, void * dat) [static]`

6.1.2.4 `void bpb_info ()`

6.1.2.5 `static void bpb_missdelay (union param_val val, void * dat) [static]`

6.1.2.6 `static void bpb_sbp_bf_fwd (union param_val val, void * dat) [static]`

6.1.2.7 `static void bpb_sbp_bnf_fwd (union param_val val, void * dat) [static]`

6.1.2.8 `void bpb_update (oraddr_t addr, int taken)`

6.1.2.9 `void btict_info ()`

6.1.2.10 `void btict_update (oraddr_t targetaddr)`

6.1.2.11 `void reg_bpb_sec ()`

Here is the call graph for this function:

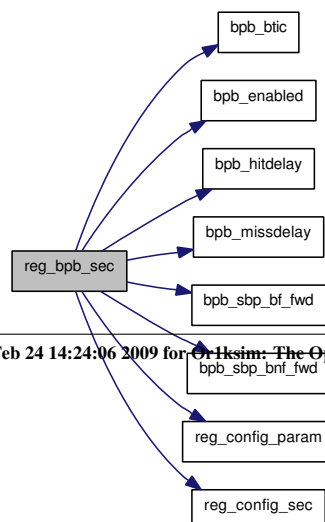

### 6.1.3 Variable Documentation

6.1.3.1 struct bpb\_entry bpb[BPB\_LEN]

6.1.3.2 struct btic\_entry btic[BTIC\_LEN]

## 6.2 bpb/branch-predict.h File Reference

```
#include "arch.h"
```

Include dependency graph for branch-predict.h:

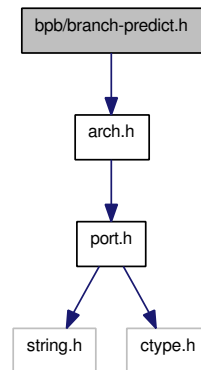

This graph shows which files directly or indirectly include this file:

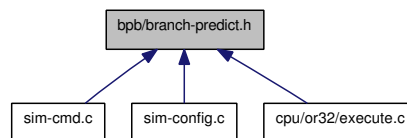

## Functions

- void `bpb_info` ()
- void `bpb_update` (`oraddr_t` addr, int taken)
- void `btic_info` ()
- void `btic_update` (`oraddr_t` targetaddr)
- void `reg_bpb_sec` ()

## 6.2.1 Function Documentation

6.2.1.1 void `bpb_info` ()

6.2.1.2 void `bpb_update` (`oraddr_t addr`, `int taken`)

6.2.1.3 void `btic_info` ()

6.2.1.4 void `btic_update` (`oraddr_t targetaddr`)

6.2.1.5 void `reg_bpb_sec` ()

Here is the call graph for this function:

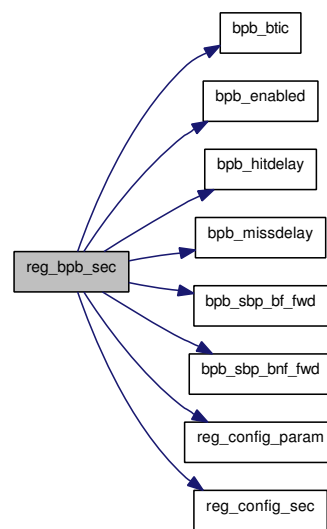

## 6.3 cache/dcache-model.c File Reference

```
#include "config.h"
#include "dcache-model.h"
#include "execute.h"
#include "spr-defs.h"
#include "abstract.h"
#include "stats.h"
#include "misc.h"
```

Include dependency graph for dcache-model.c:

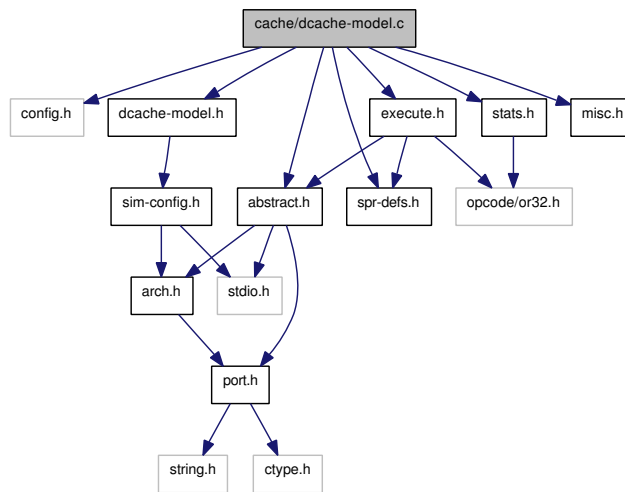

### Data Structures

- struct [dc\\_set](#)

### Functions

- void [dc\\_info](#) (void)
- uint32\_t [dc\\_simulate\\_read](#) (oraddr\_t dataaddr, oraddr\_t virt\_addr, int width)
- void [dc\\_simulate\\_write](#) (oraddr\_t dataaddr, oraddr\_t virt\_addr, uint32\_t data, int width)
- void [dc\\_inv](#) (oraddr\_t dataaddr)
- static void [dc\\_enabled](#) (union [param\\_val](#) val, void \*dat)
- static void [dc\\_nsets](#) (union [param\\_val](#) val, void \*dat)
- static void [dc\\_nways](#) (union [param\\_val](#) val, void \*dat)
- static void [dc\\_blocksize](#) (union [param\\_val](#) val, void \*dat)
- static void [dc\\_ustates](#) (union [param\\_val](#) val, void \*dat)
- static void [dc\\_load\\_hitdelay](#) (union [param\\_val](#) val, void \*dat)
- static void [dc\\_load\\_missdelay](#) (union [param\\_val](#) val, void \*dat)
- static void [dc\\_store\\_hitdelay](#) (union [param\\_val](#) val, void \*dat)
- static void [dc\\_store\\_missdelay](#) (union [param\\_val](#) val, void \*dat)
- void [reg\\_dc\\_sec](#) (void)

## Variables

- struct `dc_set dc` [MAX\_DC\_SETS]

### 6.3.1 Function Documentation

#### 6.3.1.1 `static void dc_blocksize (union param_val val, void * dat)` [static]

Set the data cache block size

Value must be either MIN\_DC\_BLOCK\_SIZE or MAX\_DC\_BLOCK\_SIZE. If not issue a warning and ignore. Set the relevant field in the data cache `config` register

##### Parameters:

- ← *val* The value to use
- ← *dat* The `config` data structure (not used here)

#### 6.3.1.2 `static void dc_enabled (union param_val val, void * dat)` [static]

Enable or disable the data cache

Set the corresponding field in the UPR

##### Parameters:

- ← *val* The value to use
- ← *dat* The `config` data structure (not used here)

#### 6.3.1.3 `void dc_info (void)`

#### 6.3.1.4 `void dc_inv (oraddr_t dataaddr)`

#### 6.3.1.5 `static void dc_load_hitdelay (union param_val val, void * dat)` [static]

#### 6.3.1.6 `static void dc_load_missdelay (union param_val val, void * dat)` [static]

#### 6.3.1.7 `static void dc_nsets (union param_val val, void * dat)` [static]

Set the number of data cache sets

Value must be a power of 2 <= MAX\_DC\_SETS. If not issue a warning and ignore. Set the relevant field in the data cache `config` register

##### Parameters:

- ← *val* The value to use
- ← *dat* The `config` data structure (not used here)

Here is the call graph for this function:

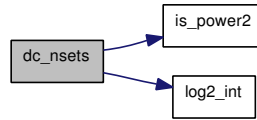

### 6.3.1.8 static void dc\_nways (union param\_val val, void \* dat) [static]

Set the number of data cache ways

Value must be a power of 2 <= MAX\_DC\_WAYS. If not issue a warning and ignore. Set the relevant field in the data cache [config](#) register

#### Parameters:

- ← *val* The value to use
- ← *dat* The [config](#) data structure (not used here)

Here is the call graph for this function:

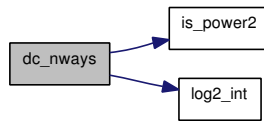

### 6.3.1.9 uint32\_t dc\_simulate\_read (oraddr\_t dataaddr, oraddr\_t virt\_addr, int width)

Here is the call graph for this function:

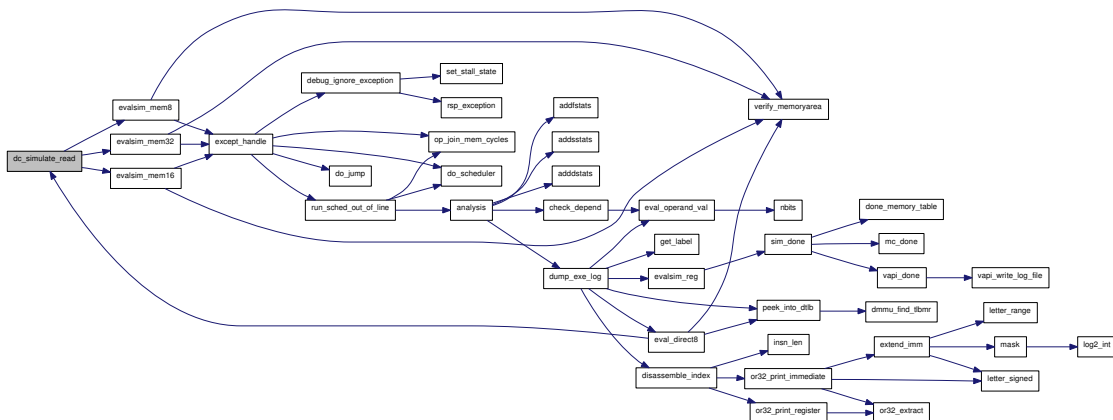



### 6.3.1.10 void dc\_simulate\_write (oraddr\_t dataaddr, oraddr\_t virt\_addr, uint32\_t data, int width)

Here is the call graph for this function:

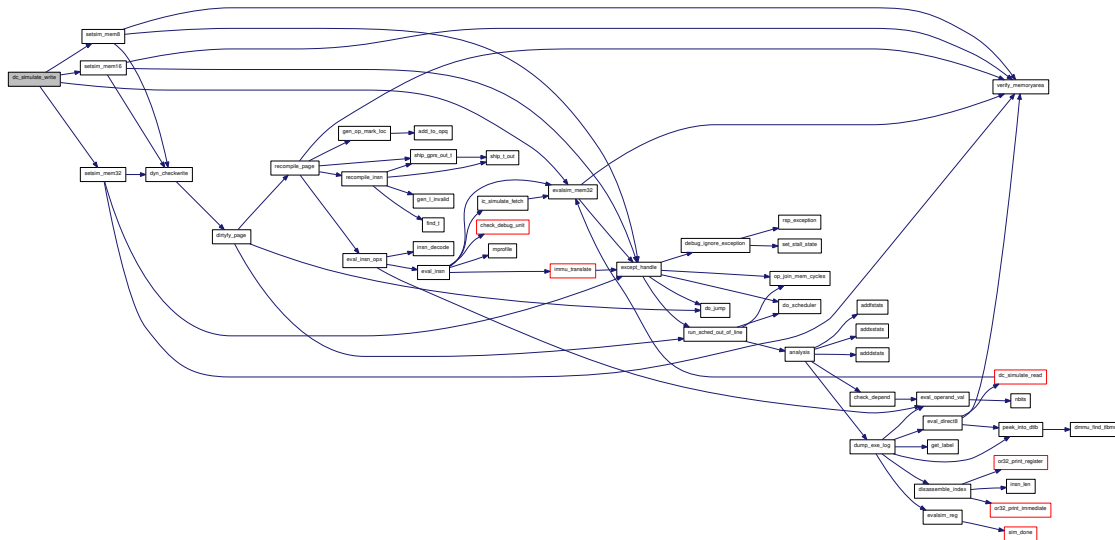

**6.3.1.11** static void dc\_store\_hitdelay (union param\_val val, void \* dat) [static]

**6.3.1.12** static void dc\_store\_missdelay (union param\_val val, void \* dat) [static]

**6.3.1.13** static void dc\_ustates (union param\_val val, void \* dat) [static]

Set the number of data cache usage states

Value must be 2, 3 or 4. If not issue a warning and ignore.

#### Parameters:

← *val* The value to use

← *dat* The [config](#) data structure (not used here)

### 6.3.1.14 void reg\_dc\_sec (void)

Here is the call graph for this function:

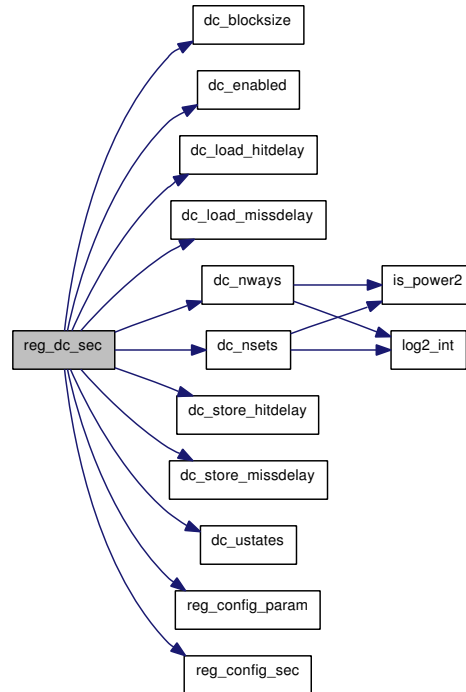

## 6.3.2 Variable Documentation

### 6.3.2.1 struct dc\_set dc[MAX\_DC\_SETS]

## 6.4 cache/dcache-model.h File Reference

```
#include "sim-config.h"
```

Include dependency graph for dcache-model.h:

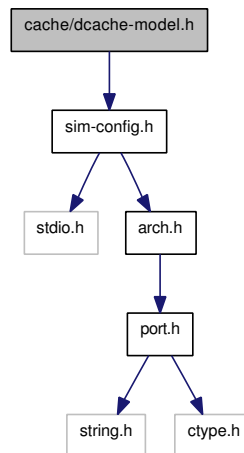

This graph shows which files directly or indirectly include this file:

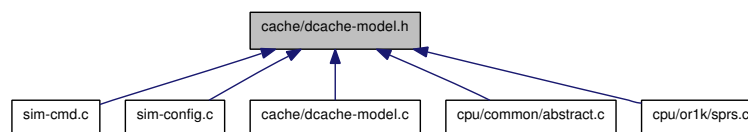

### Defines

- #define [MAX\\_DC\\_SETS](#) 1024
- #define [MAX\\_DC\\_WAYS](#) 32
- #define [MIN\\_DC\\_BLOCK\\_SIZE](#) 16
- #define [MAX\\_DC\\_BLOCK\\_SIZE](#) 32

### Functions

- [uint32\\_t dc\\_simulate\\_read](#) ([oraddr\\_t](#) dataaddr, [oraddr\\_t](#) virt\_addr, int width)
- [void dc\\_simulate\\_write](#) ([oraddr\\_t](#) dataaddr, [oraddr\\_t](#) virt\_addr, [uint32\\_t](#) data, int width)
- [void dc\\_info](#) ()
- [void dc\\_inv](#) ([oraddr\\_t](#) dataaddr)
- [void reg\\_dc\\_sec](#) ()

## 6.4.1 Define Documentation

6.4.1.1 `#define MAX_DC_BLOCK_SIZE 32`

6.4.1.2 `#define MAX_DC_SETS 1024`

6.4.1.3 `#define MAX_DC_WAYS 32`

6.4.1.4 `#define MIN_DC_BLOCK_SIZE 16`

## 6.4.2 Function Documentation

6.4.2.1 `void dc_info ()`

6.4.2.2 `void dc_inv (oraddr_t dataaddr)`

6.4.2.3 `uint32_t dc_simulate_read (oraddr_t dataaddr, oraddr_t virt_addr, int width)`

Here is the call graph for this function:

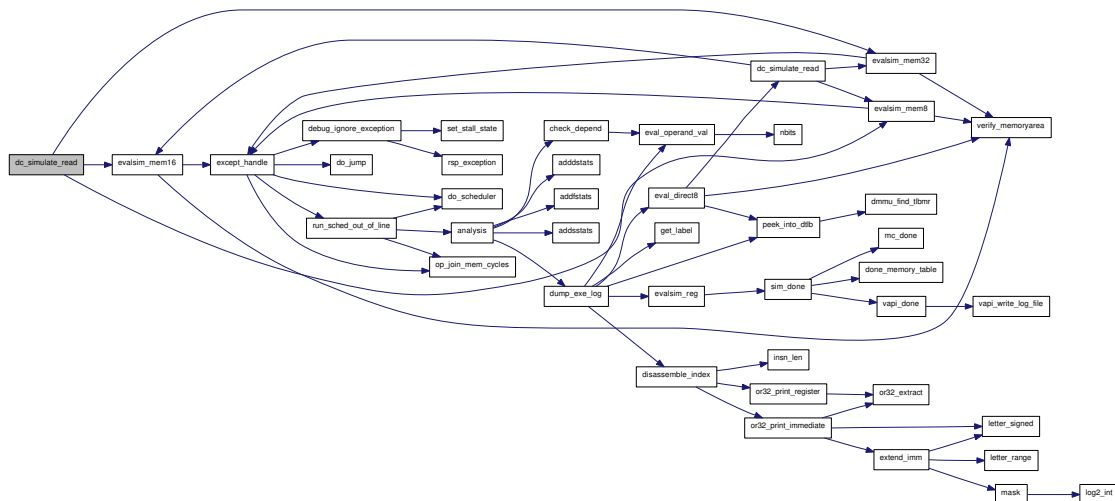



## 6.5 cache/icache-model.c File Reference

```
#include "config.h"
#include "port.h"
#include <stdlib.h>
#include "icache-model.h"
#include "execute.h"
#include "spr-defs.h"
#include "abstract.h"
#include "misc.h"
#include "stats.h"
#include "sim-cmd.h"
```

Include dependency graph for icache-model.c:

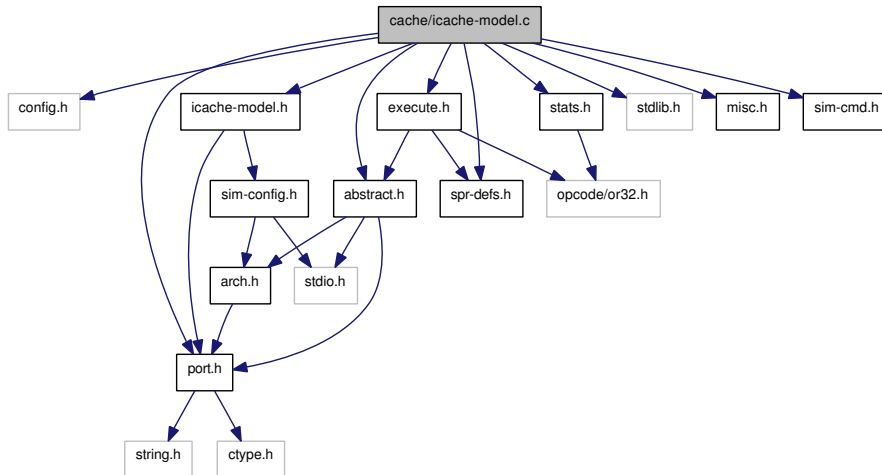

### Defines

- #define [MAX\\_IC\\_SETS](#) 1024
- #define [MAX\\_IC\\_WAYS](#) 32
- #define [MIN\\_IC\\_BLOCK\\_SIZE](#) 16
- #define [MAX\\_IC\\_BLOCK\\_SIZE](#) 32

### Functions

- static void [ic\\_info](#) (void \*dat)
- uint32\_t [ic\\_simulate\\_fetch](#) ([oraddr\\_t](#) fetchaddr, [oraddr\\_t](#) virt\_addr)
- void [ic\\_inv](#) ([oraddr\\_t](#) dataaddr)
- static void [ic\\_enabled](#) (union [param\\_val](#) val, void \*dat)
- static void [ic\\_nsets](#) (union [param\\_val](#) val, void \*dat)
- static void [ic\\_nways](#) (union [param\\_val](#) val, void \*dat)

- static void `ic_blocksize` (union `param_val` *val*, void \**dat*)
- static void `ic_ustates` (union `param_val` *val*, void \**dat*)
- static void `ic_hitdelay` (union `param_val` *val*, void \**dat*)
- static void `ic_missdelay` (union `param_val` *val*, void \**dat*)
- static void \* `ic_start_sec` ()
- static void `ic_end_sec` (void \**dat*)
- void `reg_ic_sec` (void)

## Variables

- struct `ic` \* `ic_state` = NULL

### 6.5.1 Define Documentation

**6.5.1.1** `#define MAX_IC_BLOCK_SIZE 32`

**6.5.1.2** `#define MAX_IC_SETS 1024`

**6.5.1.3** `#define MAX_IC_WAYS 32`

**6.5.1.4** `#define MIN_IC_BLOCK_SIZE 16`

### 6.5.2 Function Documentation

**6.5.2.1** `static void ic_blocksize (union param_val val, void * dat)` [`static`]

Set the instruction cache block size

Value must be either `MIN_IC_BLOCK_SIZE` or `MAX_IC_BLOCK_SIZE`. If not issue a warning and ignore. Set the relevant field in the data cache `config` register

#### Parameters:

← *val* The value to use

← *dat* The `config` data structure

**6.5.2.2** `static void ic_enabled (union param_val val, void * dat)` [`static`]

Enable or disable the instruction cache

Set the corresponding field in the UPR

#### Parameters:

← *val* The value to use

← *dat* The `config` data structure

### 6.5.2.3 static void ic\_end\_sec (void \* *dat*) [static]

Here is the call graph for this function:

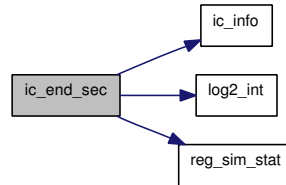

### 6.5.2.4 static void ic\_hitdelay (union param\_val *val*, void \* *dat*) [static]

### 6.5.2.5 static void ic\_info (void \* *dat*) [static]

### 6.5.2.6 void ic\_inv (oraddr\_t *dataaddr*)

### 6.5.2.7 static void ic\_missdelay (union param\_val *val*, void \* *dat*) [static]

### 6.5.2.8 static void ic\_nsets (union param\_val *val*, void \* *dat*) [static]

Set the number of instruction cache sets

Set the corresponding field in the UPR

#### Parameters:

← *val* The value to use

← *dat* The `config` data structure

Here is the call graph for this function:

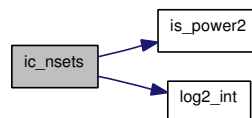

### 6.5.2.9 static void ic\_nways (union param\_val *val*, void \* *dat*) [static]

Set the number of instruction cache ways

Set the corresponding field in the UPR

#### Parameters:

← *val* The value to use

← *dat* The `config` data structure



Here is the call graph for this function:

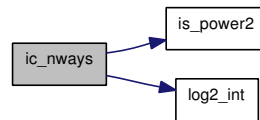

### 6.5.2.10 uint32\_t ic\_simulate\_fetch (oraddr\_t fetchaddr, oraddr\_t virt\_addr)

Here is the call graph for this function:

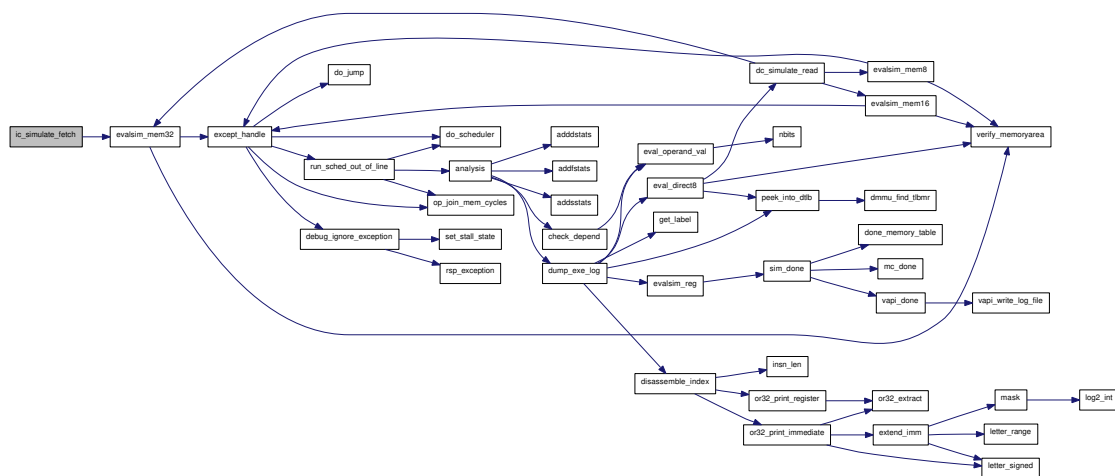

### 6.5.2.11 static void\* ic\_start\_sec () [static]

Initialize a new instruction cache configuration

ALL parameters are set explicitly to default values. Corresponding SPR flags are set as appropriate.

#### Returns:

The new memory configuration data structure

Here is the call graph for this function:



### 6.5.2.12 static void ic\_ustates (union param\_val val, void \* dat) [static]

Set the number of instruction cache usage states

Value must be 2, 3 or 4. If not issue a warning and ignore.

**Parameters:**

- ← *val* The value to use
- ← *dat* The `config` data structure

**6.5.2.13 void reg\_ic\_sec (void)**

Here is the call graph for this function:

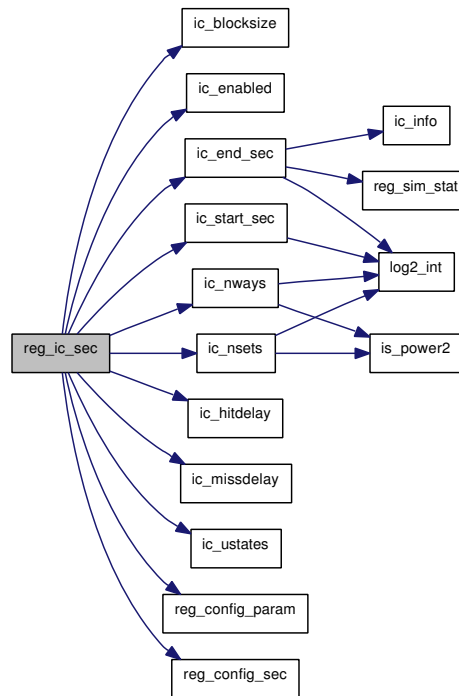
**6.5.3 Variable Documentation****6.5.3.1 struct ic\* ic\_state = NULL**

## 6.6 cache/icache-model.h File Reference

```
#include "port.h"
#include "sim-config.h"
```

Include dependency graph for icache-model.h:

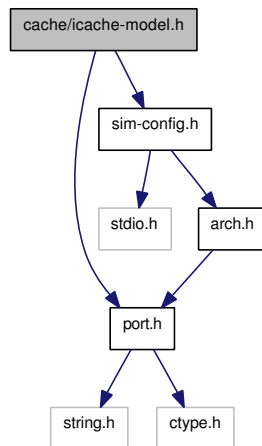

This graph shows which files directly or indirectly include this file:

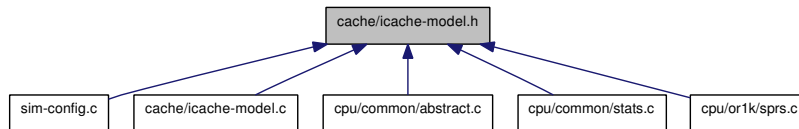

### Data Structures

- struct `ic`

### Functions

- `uint32_t ic_simulate_fetch (oraddr_t fetchaddr, oraddr_t virt_addr)`
- `void ic_inv (oraddr_t dataaddr)`
- `void reg_ic_sec ()`

### Variables

- struct `ic * ic_state`

## 6.6.1 Function Documentation

### 6.6.1.1 void ic\_inv (oraddr\_t dataaddr)

### 6.6.1.2 uint32\_t ic\_simulate\_fetch (oraddr\_t fetchaddr, oraddr\_t virt\_addr)

Here is the call graph for this function:

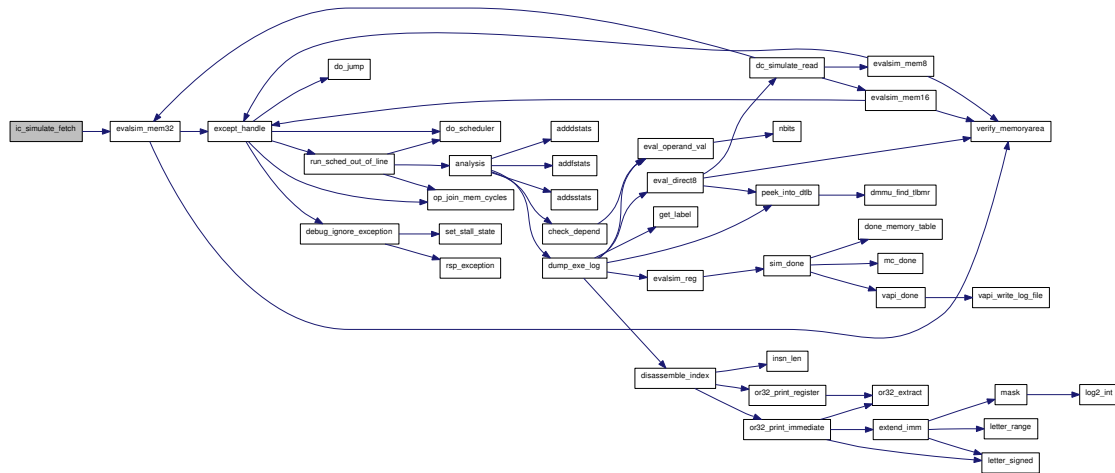

### 6.6.1.3 void reg\_ic\_sec ()

Here is the call graph for this function:

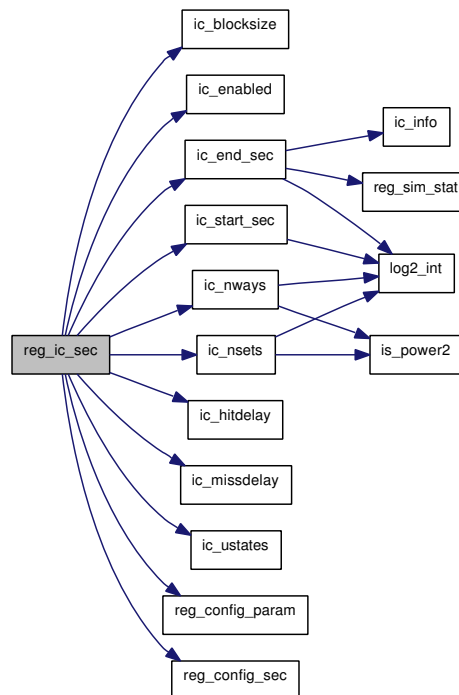

## 6.6.2 Variable Documentation

### 6.6.2.1 struct ic\* ic\_state

## 6.7 cpu-config.c File Reference

```
#include "config.h"
#include <stdio.h>
#include "cpu-config.h"
#include "sim-config.h"
#include "spr-defs.h"
#include "execute.h"
```

Include dependency graph for `cpu-config.c`:

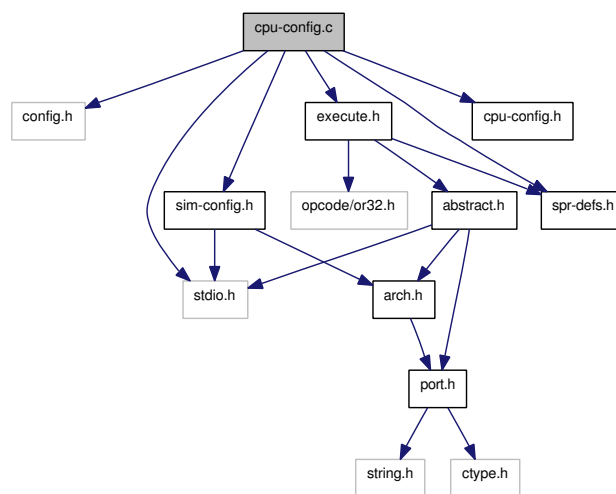

### Defines

- #define `WARNING(s)` `fprintf(stderr, "Warning: config.%s: %s\n", cur_section → name, (s))`

### Functions

- static void `cpu_ver` (union `param_val` val, void \*dat)
- static void `cpu_cfg` (union `param_val` val, void \*dat)
- static void `cpu_rev` (union `param_val` val, void \*dat)
- static void `cpu_upr` (union `param_val` val, void \*dat)
- static void `cpu_cfgr` (union `param_val` val, void \*dat)
- static void `cpu_sr` (union `param_val` val, void \*dat)
- static void `cpu_hazards` (union `param_val` val, void \*dat)
- static void `cpu_superscalar` (union `param_val` val, void \*dat)
- static void `cpu_dependstats` (union `param_val` val, void \*dat)
- static void `cpu_sbuf_len` (union `param_val` val, void \*dat)
- void `reg_cpu_sec` ()

## 6.7.1 Define Documentation

**6.7.1.1** `#define WARNING(s) fprintf(stderr, "Warning: config.%s: %s\n", cur_section → name, (s))`

## 6.7.2 Function Documentation

**6.7.2.1** `static void cpu_cfg (union param_val val, void * dat) [static]`

Set the CPU configuration

Value must be an 8-bit integer. Larger values are truncated with a warning.

### Parameters:

← *val* The value to use

← *dat* The [config](#) data structure (not used here)

**6.7.2.2** `static void cpu_cfgr (union param_val val, void * dat) [static]`

Set the CPU configuration

Value must be just the OB32S instruction set bit. Nothing else is currently supported. If other values are specified, they will be set, but with a warning.

### Parameters:

← *val* The value to use

← *dat* The [config](#) data structure (not used here)

**6.7.2.3** `static void cpu_dependstats (union param_val val, void * dat) [static]`

**6.7.2.4** `static void cpu_hazards (union param_val val, void * dat) [static]`

**6.7.2.5** `static void cpu_rev (union param_val val, void * dat) [static]`

Set the CPU revision

Value must be an 6-bit integer. Larger values are truncated with a warning.

### Parameters:

← *val* The value to use

← *dat* The [config](#) data structure (not used here)

**6.7.2.6** `static void cpu_sbuf_len (union param_val val, void * dat) [static]`

**6.7.2.7** `static void cpu_sr (union param_val val, void * dat) [static]`

Set the CPU supervision register

Only the lowest 17 bits may be set. The top 4 bits are for context ID's (not currently supported), the rest are reserved and should not be set.

If such values are specified, the value will be set (it has no effect), but with a warning.

**Parameters:**

← *val* The value to use

← *dat* The `config` data structure (not used here)

**6.7.2.8** `static void cpu_superscalar (union param_val val, void * dat) [static]`

**6.7.2.9** `static void cpu_upr (union param_val val, void * dat) [static]`

**6.7.2.10** `static void cpu_ver (union param_val val, void * dat) [static]`

Set the CPU version

Value must be an 8-bit integer. Larger values are truncated with a warning.

**Parameters:**

← *val* The value to use

← *dat* The `config` data structure (not used here)

**6.7.2.11** `void reg_cpu_sec ()`

Register the functions to handle a section cpu

This section does not allocate dynamically a data structure holding its `config` information. It's all in the global `config.sim` data structure. Therefore it does not need a start and end function to initialize default values (although it might be clearer to do so). The default values are set in `init_defconfig()`.



Here is the call graph for this function:

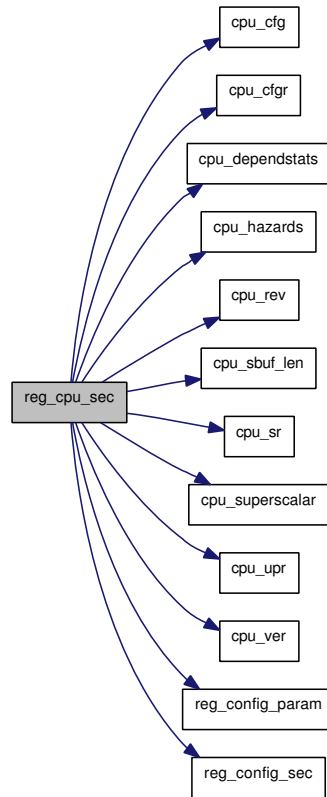

## 6.8 cpu-config.h File Reference

This graph shows which files directly or indirectly include this file:

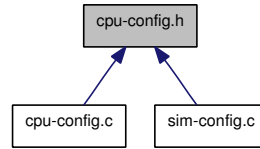

### Functions

- void [reg\\_cpu\\_sec](#) ()

#### 6.8.1 Function Documentation

##### 6.8.1.1 void [reg\\_cpu\\_sec](#) ()

Register the functions to handle a section cpu

This section does not allocate dynamically a data structure holding its [config](#) information. It's all in the global [config.sim](#) data structure. Therefore it does not need a start and end function to initialize default values (although it might be clearer to do so). The default values are set in [init\\_defconfig](#) ().

Here is the call graph for this function:

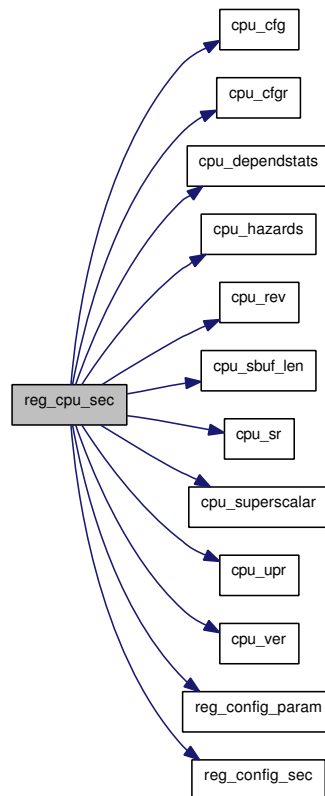

## 6.9 cpu/common/abstract.c File Reference

```
#include "config.h"
#include "port.h"
#include <stdlib.h>
#include "abstract.h"
#include "except.h"
#include "support/profile.h"
#include "debug-unit.h"
#include "icache-model.h"
#include "dcache-model.h"
#include "labels.h"
#include "opcode/or32.h"
#include "dmmu.h"
#include "immu.h"
```

Include dependency graph for abstract.c:

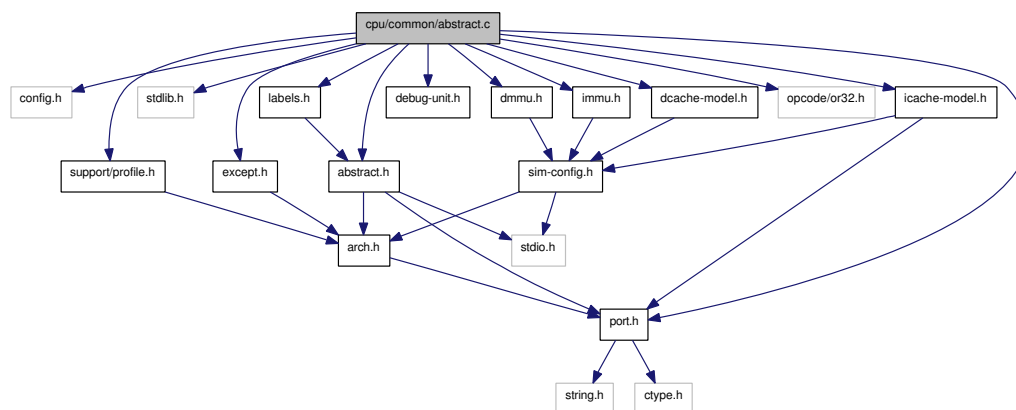

## Functions

- static uint32\_t [eval\\_mem\\_32\\_inv](#) (oraddr\_t, void \*)
- static uint16\_t [eval\\_mem\\_16\\_inv](#) (oraddr\_t, void \*)
- static uint8\_t [eval\\_mem\\_8\\_inv](#) (oraddr\_t, void \*)
- static uint32\_t [eval\\_mem\\_32\\_inv\\_direct](#) (oraddr\_t, void \*)
- static uint16\_t [eval\\_mem\\_16\\_inv\\_direct](#) (oraddr\_t, void \*)
- static uint8\_t [eval\\_mem\\_8\\_inv\\_direct](#) (oraddr\_t, void \*)
- static void [set\\_mem\\_32\\_inv](#) (oraddr\_t, uint32\_t, void \*)
- static void [set\\_mem\\_16\\_inv](#) (oraddr\_t, uint16\_t, void \*)
- static void [set\\_mem\\_8\\_inv](#) (oraddr\_t, uint8\_t, void \*)
- static void [set\\_mem\\_32\\_inv\\_direct](#) (oraddr\_t, uint32\_t, void \*)
- static void [set\\_mem\\_16\\_inv\\_direct](#) (oraddr\_t, uint16\_t, void \*)
- static void [set\\_mem\\_8\\_inv\\_direct](#) (oraddr\_t, uint8\_t, void \*)

- static unsigned int `bit_mask` (uint32\_t data)
- static struct `dev_memarea` \* `register_memoryarea_mask` (oraddr\_t addr\_mask, oraddr\_t addr\_-, compare, uint32\_t size, unsigned mc\_dev)
- struct `dev_memarea` \* `reg_mem_area` (oraddr\_t addr, uint32\_t size, unsigned mc\_dev, struct `mem_ops` \*ops)
- struct `dev_memarea` \* `verify_memoryarea` (oraddr\_t addr)
- void `set_mem_valid` (struct `dev_memarea` \*mem, int valid)
- void `adjust_rw_delay` (struct `dev_memarea` \*mem, int delayr, int delayw)
- uint32\_t `evalsim_mem32` (oraddr\_t memaddr, oraddr\_t vaddr)
- uint16\_t `evalsim_mem16` (oraddr\_t memaddr, oraddr\_t vaddr)
- uint8\_t `evalsim_mem8` (oraddr\_t memaddr, oraddr\_t vaddr)
- uint32\_t `eval_mem32` (oraddr\_t memaddr, int \*breakpoint)
- uint32\_t `eval_direct32` (oraddr\_t memaddr, int through\_mmu, int through\_dc)
- uint32\_t `eval_insn` (oraddr\_t memaddr, int \*breakpoint)
- uint16\_t `eval_mem16` (oraddr\_t memaddr, int \*breakpoint)
- uint16\_t `eval_direct16` (oraddr\_t memaddr, int through\_mmu, int through\_dc)
- uint8\_t `eval_mem8` (oraddr\_t memaddr, int \*breakpoint)
- uint8\_t `eval_direct8` (oraddr\_t memaddr, int through\_mmu, int through\_dc)
- void `setsim_mem32` (oraddr\_t memaddr, oraddr\_t vaddr, uint32\_t value)
- void `setsim_mem16` (oraddr\_t memaddr, oraddr\_t vaddr, uint16\_t value)
- void `setsim_mem8` (oraddr\_t memaddr, oraddr\_t vaddr, uint8\_t value)
- void `set_mem32` (oraddr\_t memaddr, uint32\_t value, int \*breakpoint)
- void `set_direct32` (oraddr\_t memaddr, uint32\_t value, int through\_mmu, int through\_dc)
- void `set_mem16` (oraddr\_t memaddr, uint16\_t value, int \*breakpoint)
- void `set_direct16` (oraddr\_t memaddr, uint16\_t value, int through\_mmu, int through\_dc)
- void `set_mem8` (oraddr\_t memaddr, uint8\_t value, int \*breakpoint)
- void `set_direct8` (oraddr\_t memaddr, uint8\_t value, int through\_mmu, int through\_dc)
- void `set_program32` (oraddr\_t memaddr, uint32\_t value)
- void `set_program8` (oraddr\_t memaddr, uint8\_t value)
- void `dump_memory` (oraddr\_t from, oraddr\_t to)
- void `disassemble_memory` (oraddr\_t from, oraddr\_t to, int nl)
- void `done_memory_table` ()
- void `memory_table_status` (void)
- char \* `generate_time_pretty` (char \*dest, long time\_ps)

## Variables

- struct `dev_memarea` \* `cur_area`
- int `data_ci`
- int `insn_ci`
- static struct `dev_memarea` \* `dev_list`
- static struct `dev_memarea` \* `mc_area` = NULL
- static oraddr\_t `cur_vadd`

## 6.9.1 Function Documentation

**6.9.1.1** void `adjust_rw_delay` (`struct dev_memarea * mem`, `int delayr`, `int delayw`)

**6.9.1.2** static unsigned int `bit_mask` (`uint32_t data`) [`static`]

**6.9.1.3** void `disassemble_memory` (`oraddr_t from`, `oraddr_t to`, `int nl`)

Disassemble memory to the current output

Output format is symbolic disassembly, one instruction per line. Start each line with its address and (optionally) its symbolic name.

There are all sorts of ways to trip this up, but they are unlikely. The validity of a memory area is taken from the address of the start of a line to be printed, so assumes the following 3 bytes are present. This could be fooled by ridiculous memory declarations.

### Parameters:

- ← *from* Start address of the area of memory
- ← *to* End address of the area of memory
- ← *nl* If non-zero (true) print a newline at the end of each line

Here is the call graph for this function:

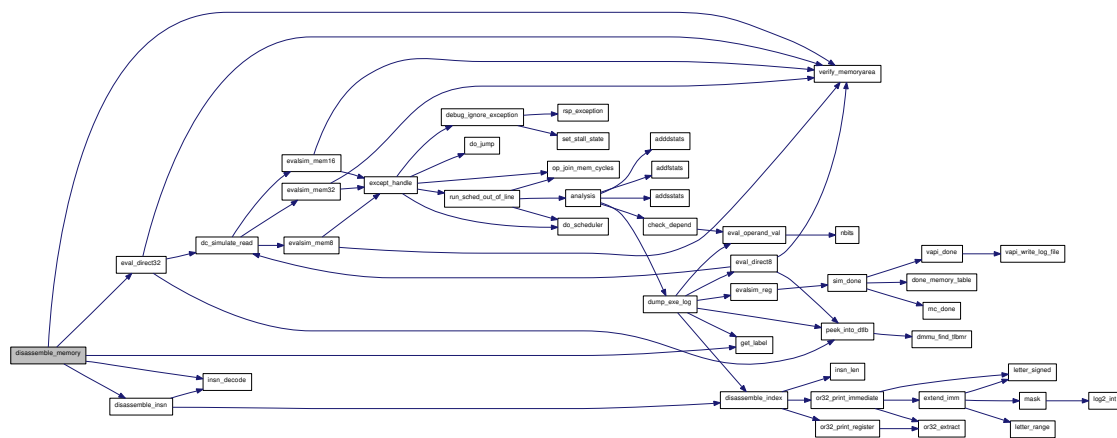

**6.9.1.4** void `done_memory_table` ()

**6.9.1.5** void `dump_memory` (`oraddr_t from`, `oraddr_t to`)

Dump memory to the current output

Output format is hex bytes, 16 bytes per line. Start each line with its address and (optionally) its symbolic name. Always end with a newline.

There are all sorts of ways to trip this up, but they are unlikely. The validity of a memory area is taken from the address of the start of a line to be printed, so assumes the following 15 bytes are present. This could be fooled by ridiculous memory declarations.



### 6.9.1.7 uint32\_t eval\_direct32 (oraddr\_t memaddr, int through\_mmu, int through\_dc)

Here is the call graph for this function:

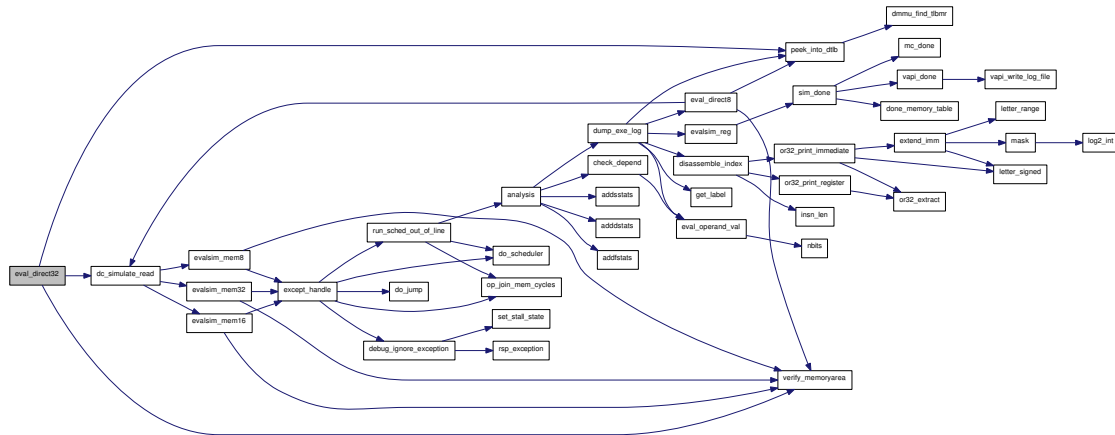

### 6.9.1.8 uint8\_t eval\_direct8 (oraddr\_t memaddr, int through\_mmu, int through\_dc)

Here is the call graph for this function:

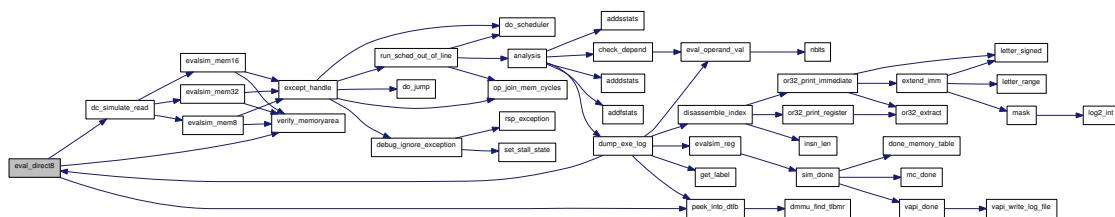

### 6.9.1.9 uint32\_t eval\_insn (oraddr\_t memaddr, int \* breakpoint)

Here is the call graph for this function:

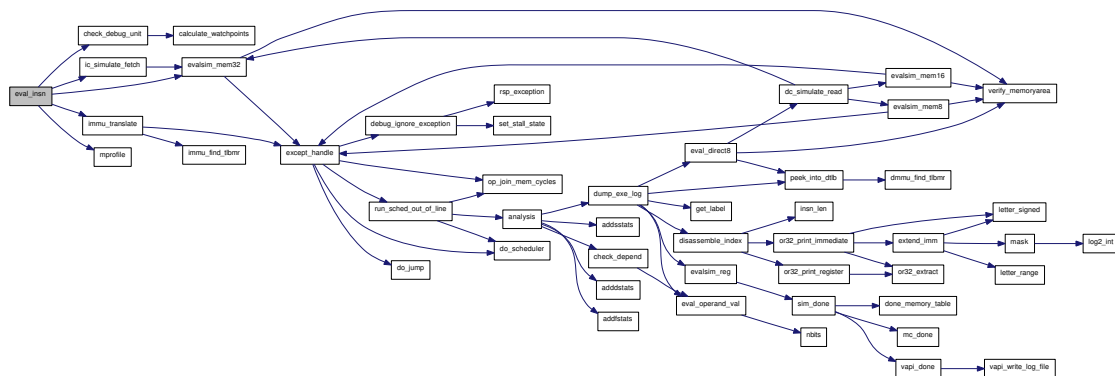

### 6.9.1.10 uint16\_t eval\_mem16 (oraddr\_t memaddr, int \* breakpoint)

Here is the call graph for this function:

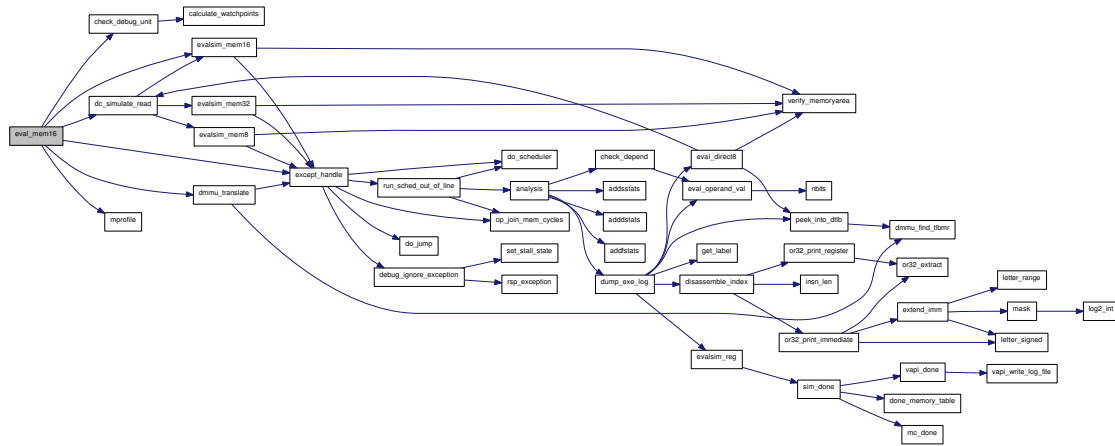

### 6.9.1.11 uint32\_t eval\_mem32 (oraddr\_t memaddr, int \* breakpoint)

Here is the call graph for this function:

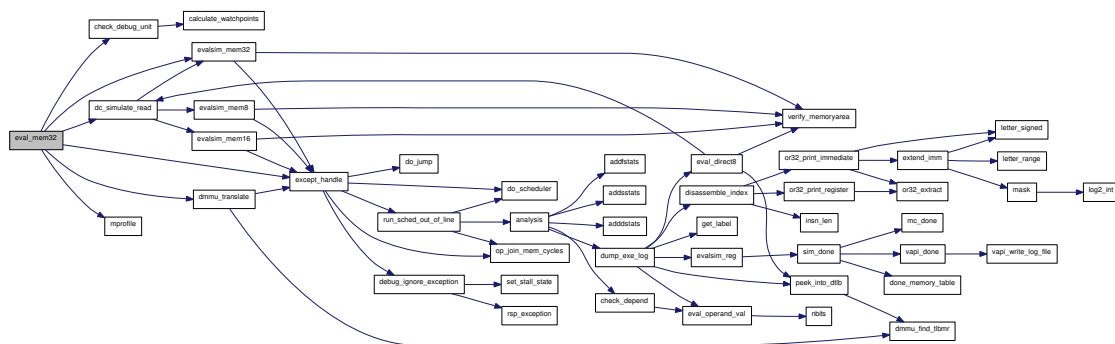



## 6.9.1.12 uint8\_t eval\_mem8 (oraddr\_t memaddr, int \* breakpoint)

Here is the call graph for this function:

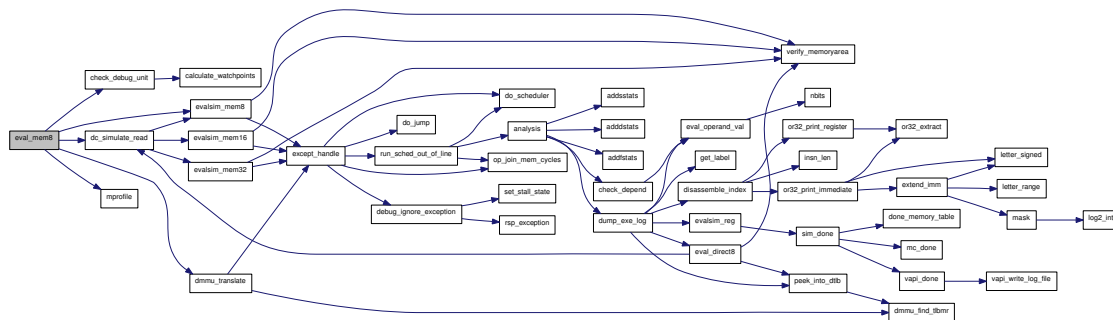

## 6.9.1.13 static uint16\_t eval\_mem\_16\_inv (oraddr\_t memaddr, void \* dat) [static]

Here is the call graph for this function:

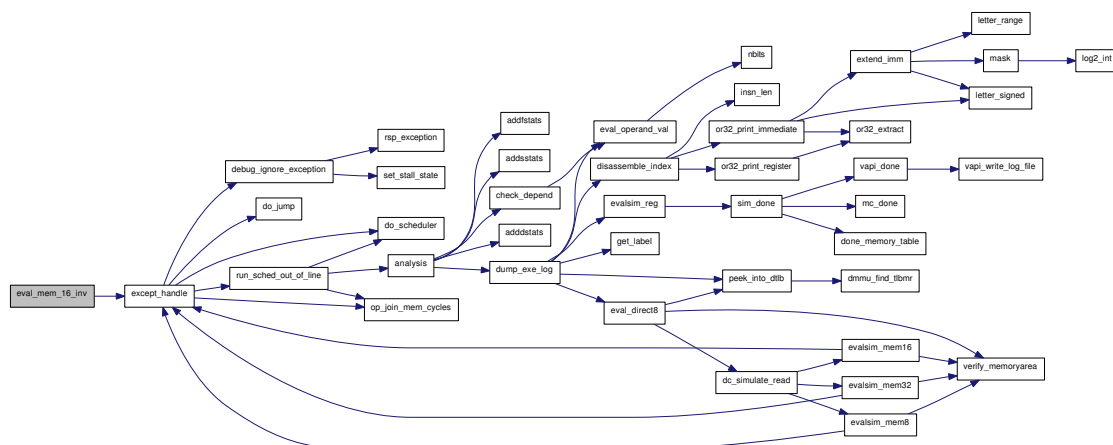

**6.9.1.14** `uint16_t eval_mem_16_inv_direct (oraddr_t memaddr, void * dat)` [static]

**6.9.1.15** `static uint32_t eval_mem_32_inv (oraddr_t memaddr, void * dat)` [static]

Here is the call graph for this function:

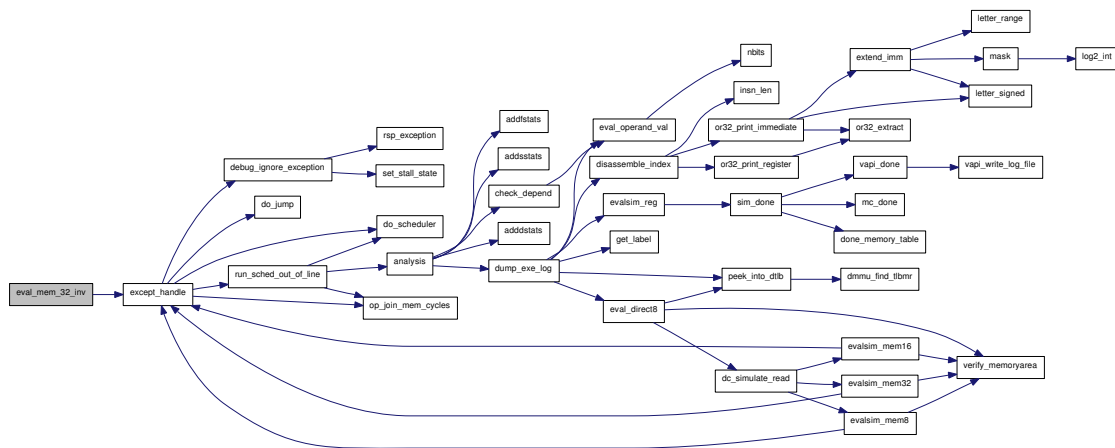

**6.9.1.16** `uint32_t eval_mem_32_inv_direct (oraddr_t memaddr, void * dat)` [static]

**6.9.1.17** `static uint8_t eval_mem_8_inv (oraddr_t memaddr, void * dat)` [static]

Here is the call graph for this function:

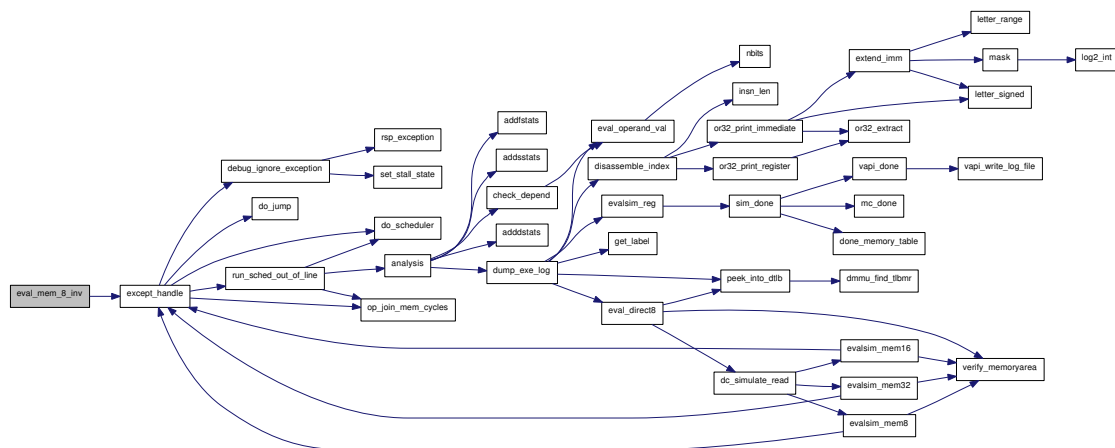

**6.9.1.18** `uint8_t eval_mem_8_inv_direct (oraddr_t memaddr, void * dat)` [static]

**6.9.1.19** `uint16_t evalsim_mem16 (oraddr_t memaddr, oraddr_t vaddr)`

Here is the call graph for this function:

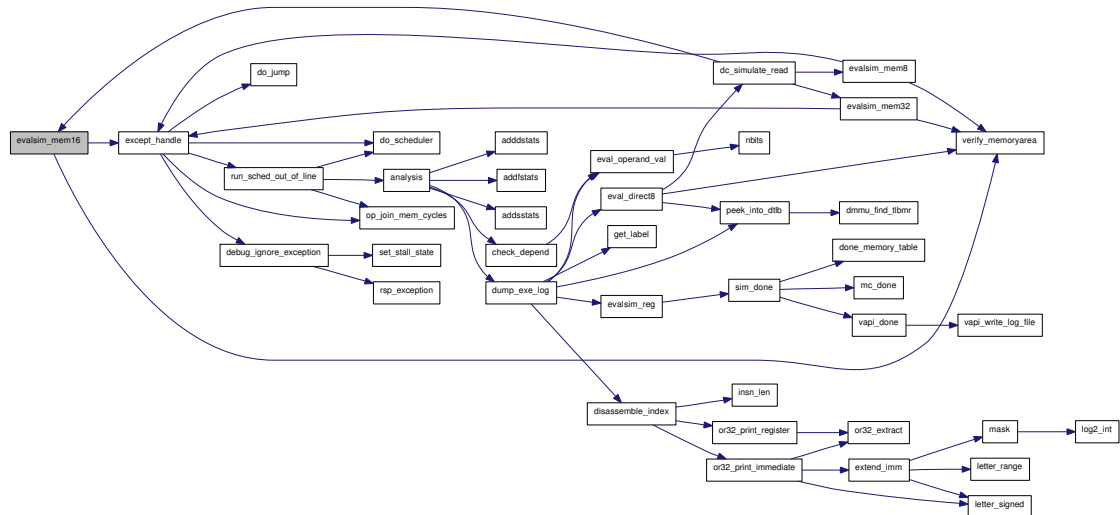

**6.9.1.20** `uint32_t evalsim_mem32 (oraddr_t memaddr, oraddr_t vaddr)`

Here is the call graph for this function:

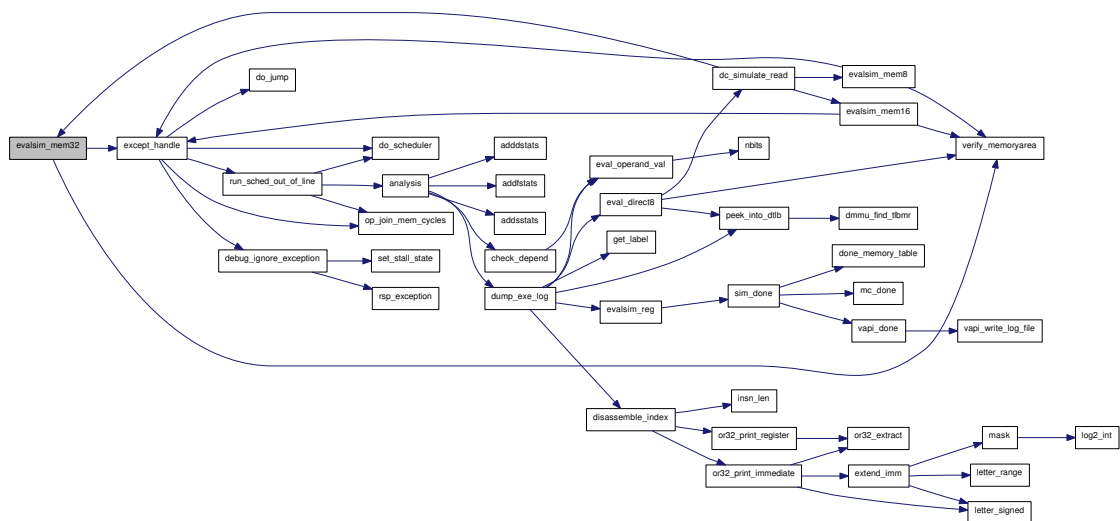

### 6.9.1.21 uint8\_t evalsim\_mem8 (oraddr\_t memaddr, oraddr\_t vaddr)

Here is the call graph for this function:

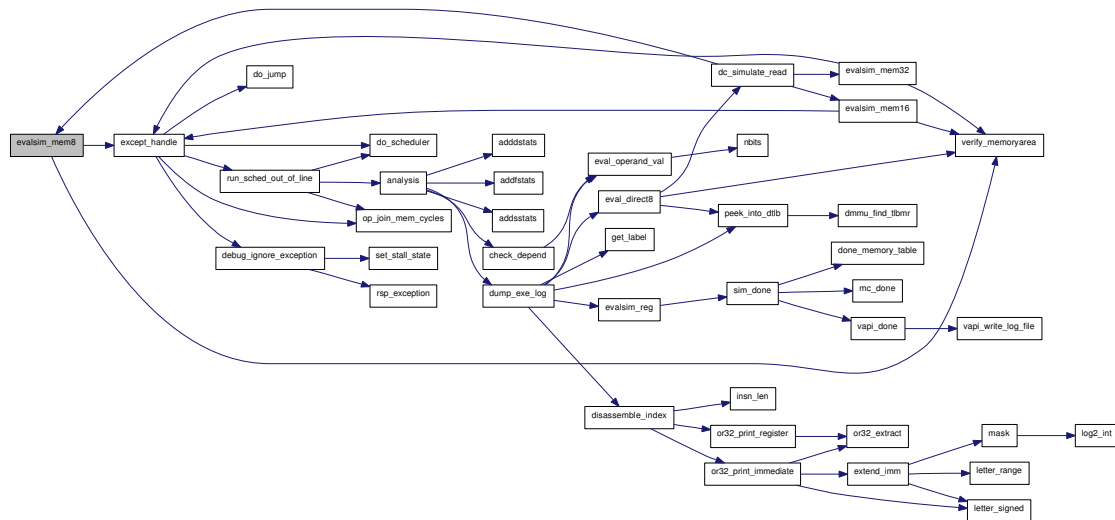

### 6.9.1.22 char\* generate\_time\_pretty (char \* dest, long time\_ps)

### 6.9.1.23 void memory\_table\_status (void)

Here is the call graph for this function:

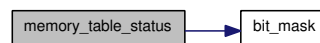

### 6.9.1.24 struct dev\_memarea\* reg\_mem\_area (oraddr\_t addr, uint32\_t size, unsigned mc\_dev, struct mem\_ops \* ops) [read]

Here is the call graph for this function:

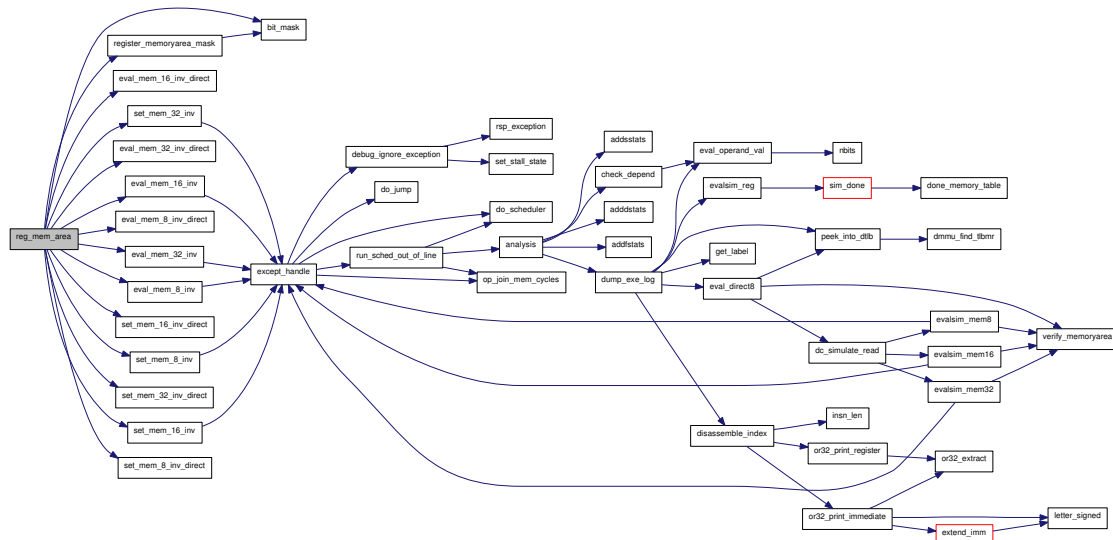

### 6.9.1.25 static struct dev\_memarea\* register\_memoryarea\_mask (oraddr\_t addr\_mask, oraddr\_t addr\_compare, uint32\_t size, unsigned mc\_dev) [static, read]

Here is the call graph for this function:

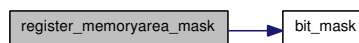









### 6.9.1.32 static void set\_mem\_16\_inv (oraddr\_t memaddr, uint16\_t val, void \* dat) [static]

Here is the call graph for this function:

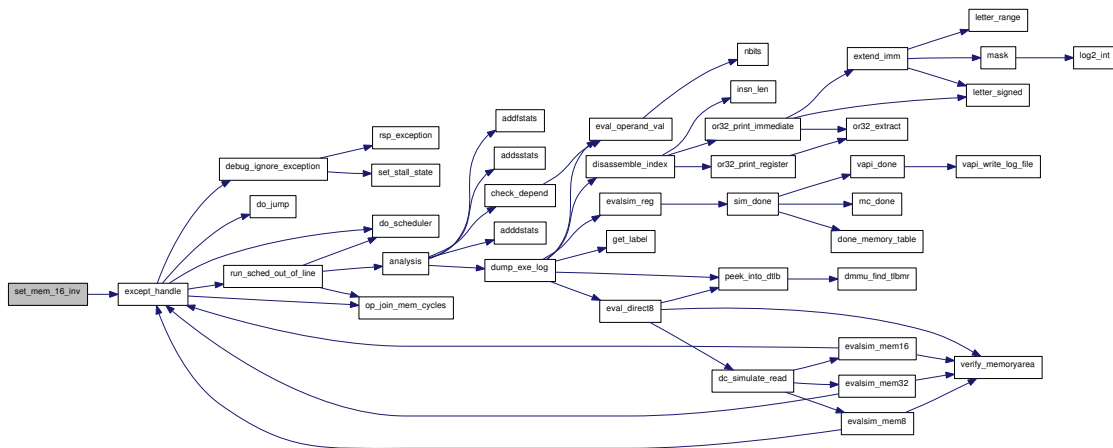

### 6.9.1.33 void set\_mem\_16\_inv\_direct (oraddr\_t memaddr, uint16\_t val, void \* dat) [static]

### 6.9.1.34 static void set\_mem\_32\_inv (oraddr\_t memaddr, uint32\_t val, void \* dat) [static]

Here is the call graph for this function:

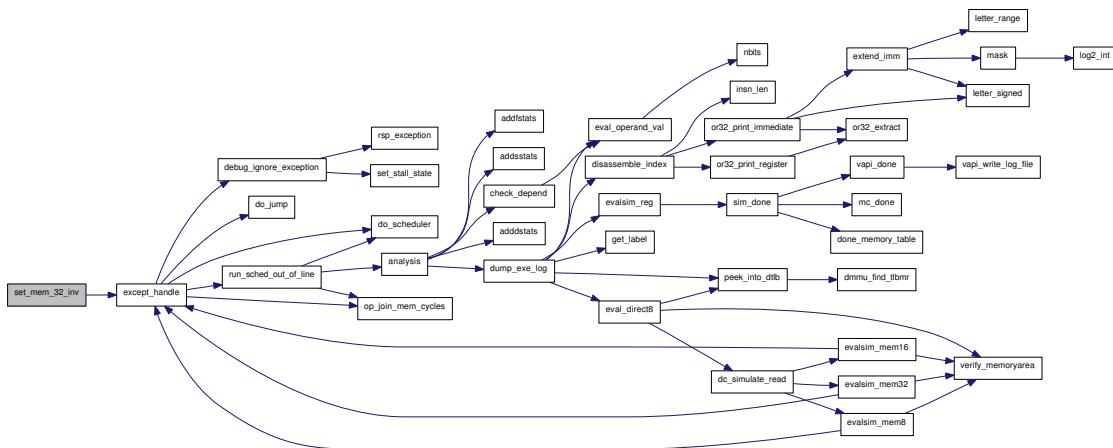

**6.9.1.35** void set\_mem\_32\_inv\_direct (oraddr\_t memaddr, uint32\_t val, void \* dat) [static]

**6.9.1.36** static void set\_mem\_8\_inv (oraddr\_t memaddr, uint8\_t val, void \* dat) [static]

Here is the call graph for this function:

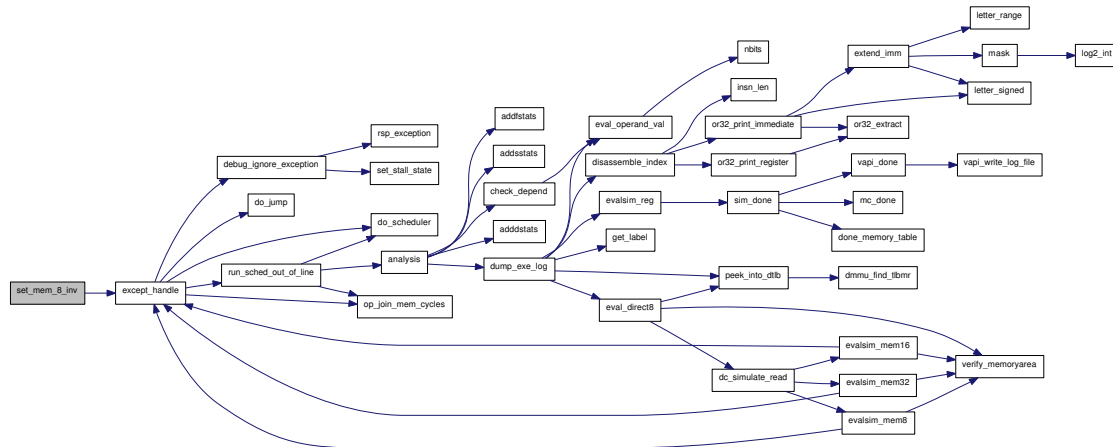

**6.9.1.37** void set\_mem\_8\_inv\_direct (oraddr\_t memaddr, uint8\_t val, void \* dat) [static]

**6.9.1.38** void set\_mem\_valid (struct dev\_memarea \* mem, int valid)

**6.9.1.39** void set\_program32 (oraddr\_t memaddr, uint32\_t value)

Here is the call graph for this function:



**6.9.1.40** void set\_program8 (oraddr\_t memaddr, uint8\_t value)

Here is the call graph for this function:



6.9.1.41 void setsim\_mem16 (oraddr\_t memaddr, oraddr\_t vaddr, uint16\_t value)

Here is the call graph for this function:

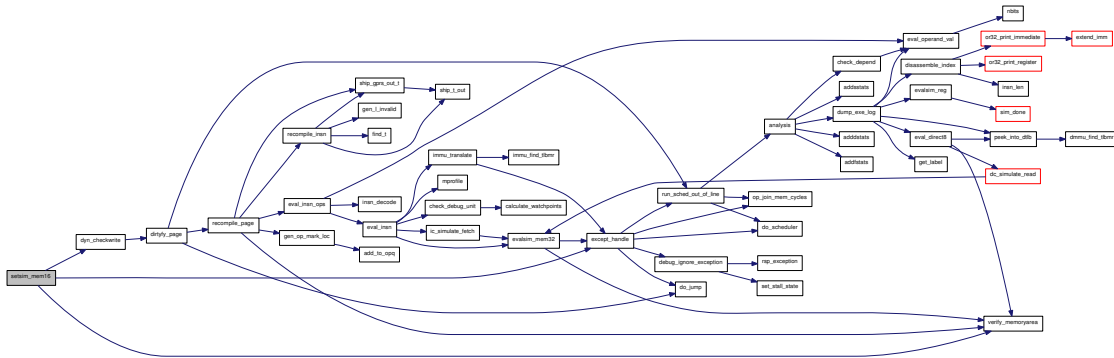

6.9.1.42 void setsim\_mem32 (oraddr\_t memaddr, oraddr\_t vaddr, uint32\_t value)

Here is the call graph for this function:

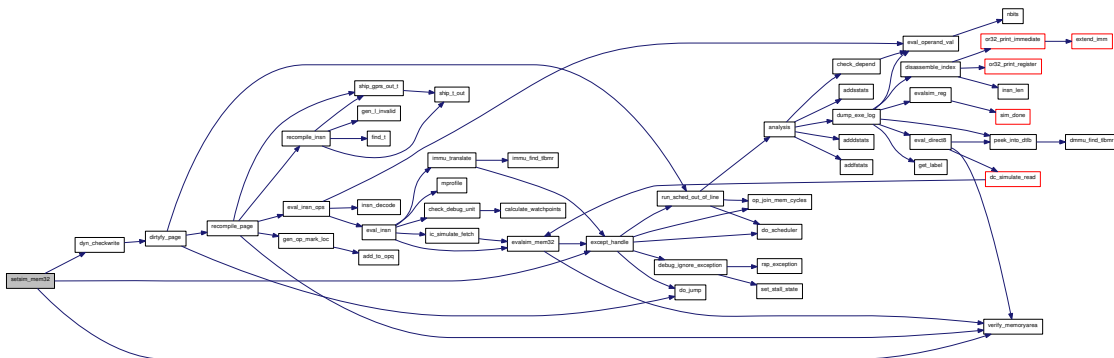

6.9.1.43 void setsim\_mem8 (oraddr\_t memaddr, oraddr\_t vaddr, uint8\_t value)

Here is the call graph for this function:

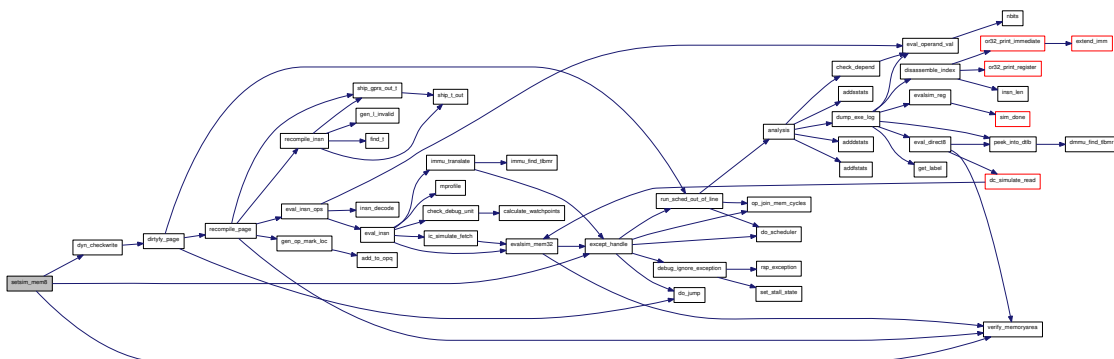

**6.9.1.44** `struct dev_memarea* verify_memoryarea (oraddr_t addr)` [read]

## 6.9.2 Variable Documentation

**6.9.2.1** `struct dev_memarea* cur_area`

Global temporary variable to increase speed.

**6.9.2.2** `oraddr_t cur_vadd` [static]

**6.9.2.3** `int data_ci`

Global var: data cache inhibit bit set

**6.9.2.4** `struct dev_memarea* dev_list` [static]

**6.9.2.5** `int insn_ci`

Global var: instr cache inhibit bit set

**6.9.2.6** `struct dev_memarea* mc_area = NULL` [static]

## 6.10 cpu/common/abstract.h File Reference

```
#include "port.h"
#include <stdio.h>
#include "arch.h"
```

Include dependency graph for abstract.h:

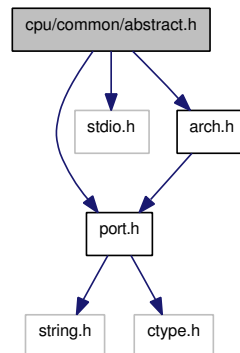

This graph shows which files directly or indirectly include this file:



### Data Structures

- struct [iqueue\\_entry](#)
- struct [mem\\_ops](#)
- struct [dev\\_memarea](#)

### Defines

- #define [DEFAULT\\_MEMORY\\_START](#) 0
- #define [DEFAULT\\_MEMORY\\_LEN](#) 0x800000
- #define [STACK\\_SIZE](#) 20
- #define [LABELNAME\\_LEN](#) 50
- #define [INSNAME\\_LEN](#) 15
- #define [OPERANDNAME\\_LEN](#) 50
- #define [MAX\\_OPERANDS](#) 5
- #define [OP\\_MEM\\_ACCESS](#) 0x80000000
- #define [CT\\_NONE](#) 0
- #define [CT\\_VIRTUAL](#) 1
- #define [CT\\_PHYSICAL](#) 2
- #define [HISTEXEC\\_LEN](#) 200
- #define [LONGEST](#) long long
- #define [ULONGEST](#) unsigned long long
- #define [LE16\(x\)](#) bswap\_16(x)

## Functions

- `uint32_t eval_mem32 (oraddr_t memaddr, int *)`
- `uint16_t eval_mem16 (oraddr_t memaddr, int *)`
- `uint8_t eval_mem8 (oraddr_t memaddr, int *)`
- `void set_mem32 (oraddr_t memaddr, uint32_t value, int *)`
- `void set_mem16 (oraddr_t memaddr, uint16_t value, int *)`
- `void set_mem8 (oraddr_t memaddr, uint8_t value, int *)`
- `void dump_memory (oraddr_t from, oraddr_t to)`
- `void disassemble_memory (oraddr_t from, oraddr_t to, int nl)`
- `uint32_t evalsim_mem32 (oraddr_t, oraddr_t)`
- `uint16_t evalsim_mem16 (oraddr_t, oraddr_t)`
- `uint8_t evalsim_mem8 (oraddr_t, oraddr_t)`
- `void setsim_mem32 (oraddr_t, oraddr_t, uint32_t)`
- `void setsim_mem16 (oraddr_t, oraddr_t, uint16_t)`
- `void setsim_mem8 (oraddr_t, oraddr_t, uint8_t)`
- `void done_memory_table ()`
- `void memory_table_status (void)`
- `struct dev_memarea * reg_mem_area (oraddr_t addr, uint32_t size, unsigned mc_dev, struct mem_ops *ops)`
- `void adjust_rw_delay (struct dev_memarea *mem, int delayr, int delayw)`
- `void set_mem_valid (struct dev_memarea *mem, int valid)`
- `struct dev_memarea * verify_memoryarea (oraddr_t addr)`
- `char * generate_time_pretty (char *dest, long time_ps)`
- `uint32_t eval_insn (oraddr_t, int *)`
- `uint32_t eval_direct32 (oraddr_t addr, int through_mmu, int through_dc)`
- `uint16_t eval_direct16 (oraddr_t memaddr, int through_mmu, int through_dc)`
- `uint8_t eval_direct8 (oraddr_t memaddr, int through_mmu, int through_dc)`
- `void set_direct8 (oraddr_t, uint8_t, int, int)`
- `void set_direct16 (oraddr_t, uint16_t, int, int)`
- `void set_direct32 (oraddr_t, uint32_t, int, int)`
- `void set_program32 (oraddr_t memaddr, uint32_t value)`
- `void set_program8 (oraddr_t memaddr, uint8_t value)`

## Variables

- `struct dev_memarea * cur_area`
- `int data_ci`
- `int insn_ci`
- `struct hist_exec * hist_exec_tail`

## 6.10.1 Define Documentation

- 6.10.1.1 `#define CT_NONE 0`
- 6.10.1.2 `#define CT_PHYSICAL 2`
- 6.10.1.3 `#define CT_VIRTUAL 1`
- 6.10.1.4 `#define DEFAULT_MEMORY_LEN 0x800000`
- 6.10.1.5 `#define DEFAULT_MEMORY_START 0`
- 6.10.1.6 `#define HISTEXEC_LEN 200`
- 6.10.1.7 `#define INSNAME_LEN 15`
- 6.10.1.8 `#define LABELNAME_LEN 50`
- 6.10.1.9 `#define LE16(x) bswap_16(x)`
- 6.10.1.10 `#define LONGEST long long`
- 6.10.1.11 `#define MAX_OPERANDS 5`
- 6.10.1.12 `#define OP_MEM_ACCESS 0x80000000`
- 6.10.1.13 `#define OPERANDNAME_LEN 50`
- 6.10.1.14 `#define STACK_SIZE 20`
- 6.10.1.15 `#define ULONGEST unsigned long long`

## 6.10.2 Function Documentation

- 6.10.2.1 `void adjust_rw_delay (struct dev_memarea * mem, int delayr, int delayw)`
- 6.10.2.2 `void disassemble_memory (oraddr_t from, oraddr_t to, int nl)`

Disassemble memory to the current output

Output format is symbolic disassembly, one instruction per line. Start each line with its address and (optionally) its symbolic name.

There are all sorts of ways to trip this up, but they are unlikely. The validity of a memory area is taken from the address of the start of a line to be printed, so assumes the following 3 bytes are present. This could be fooled by ridiculous memory declarations.

### Parameters:

- ← *from* Start address of the area of memory
- ← *to* End address of the area of memory
- ← *nl* If non-zero (true) print a newline at the end of each line

Here is the call graph for this function:

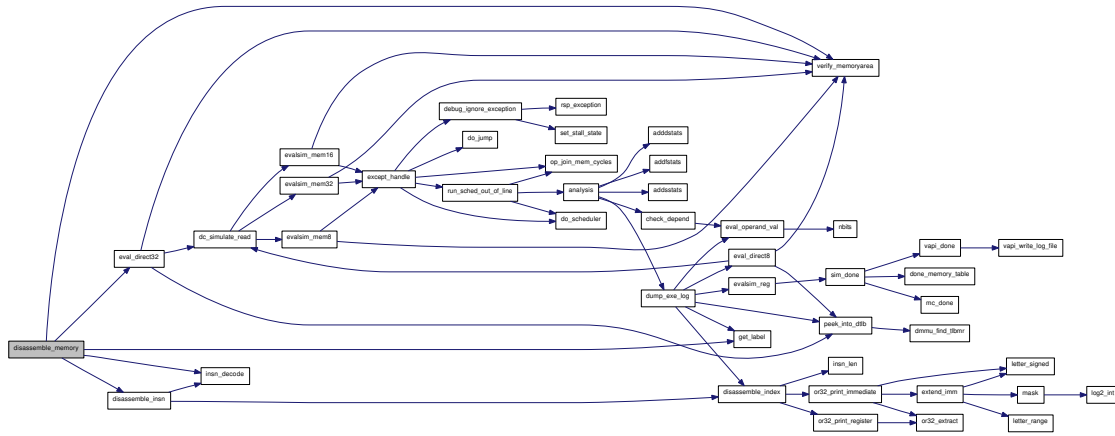

### 6.10.2.3 void done\_memory\_table ()

### 6.10.2.4 void dump\_memory (oraddr\_t from, oraddr\_t to)

Dump memory to the current output

Output format is hex bytes, 16 bytes per line. Start each line with its address and (optionally) its symbolic name. Always end with a newline.

There are all sorts of ways to trip this up, but they are unlikely. The validity of a memory area is taken from the address of the start of a line to be printed, so assumes the following 15 bytes are present. This could be fooled by ridiculous memory declarations.

#### Parameters:

← *from* Start address of the area of memory

← *to* End address of the area of memory

Here is the call graph for this function:

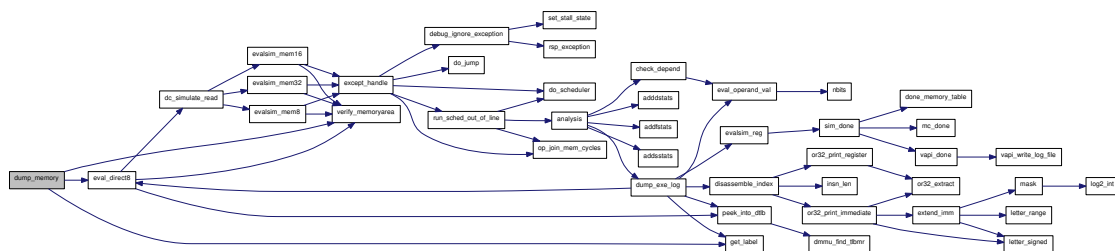



### 6.10.2.5 uint16\_t eval\_direct16 (oraddr\_t memaddr, int through\_mmu, int through\_dc)

Here is the call graph for this function:

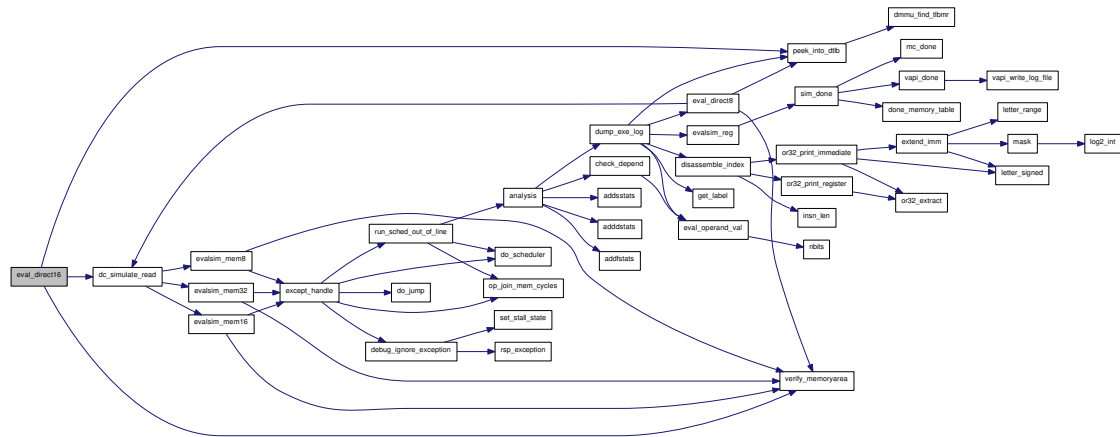

### 6.10.2.6 uint32\_t eval\_direct32 (oraddr\_t addr, int through\_mmu, int through\_dc)

Here is the call graph for this function:

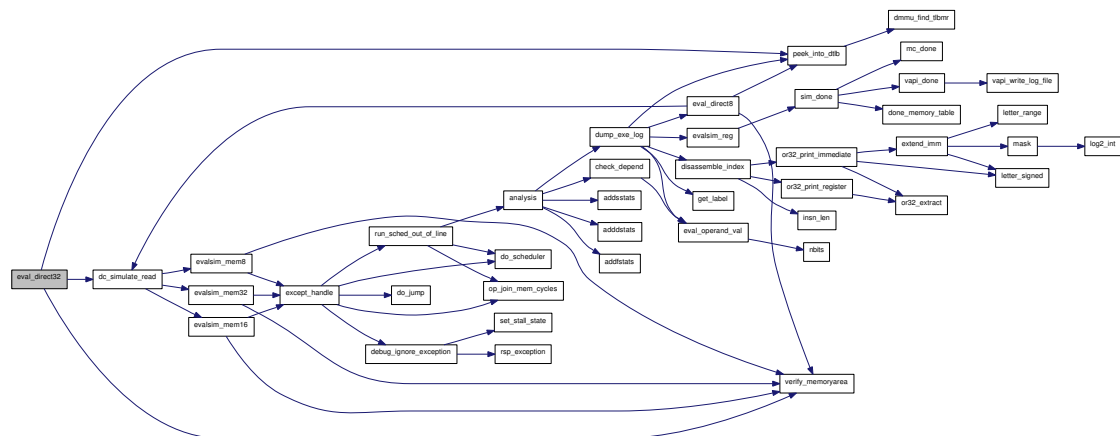

### 6.10.2.7 uint8\_t eval\_direct8 (oraddr\_t memaddr, int through\_mmu, int through\_dc)

Here is the call graph for this function:

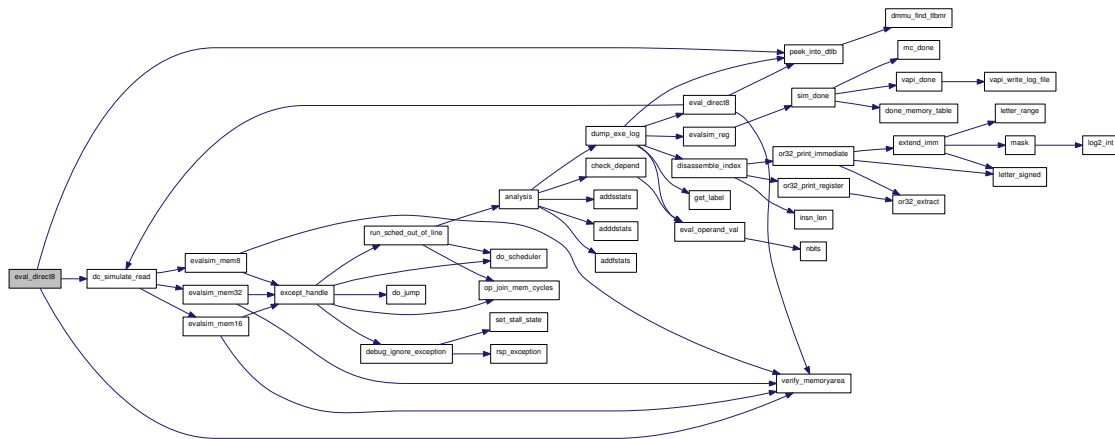

### 6.10.2.8 uint32\_t eval\_insn (oraddr\_t, int \*)

Here is the call graph for this function:

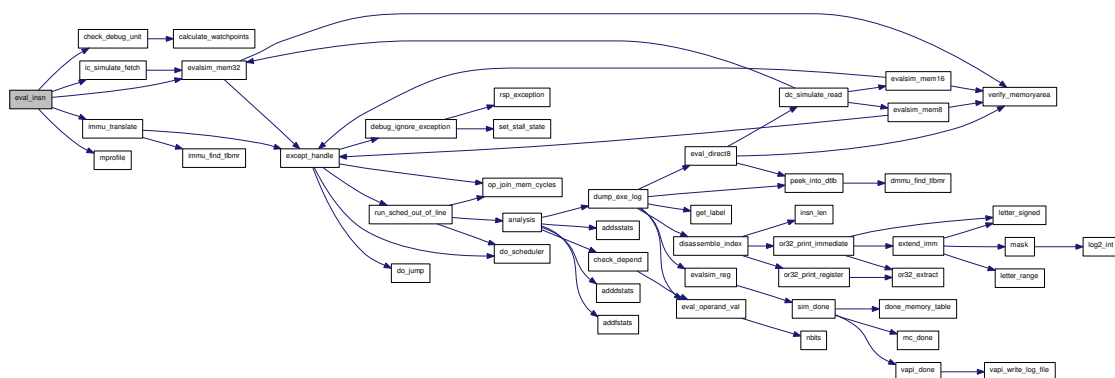

## 6.10.2.9 uint16\_t eval\_mem16 (oraddr\_t memaddr, int \*)

Here is the call graph for this function:

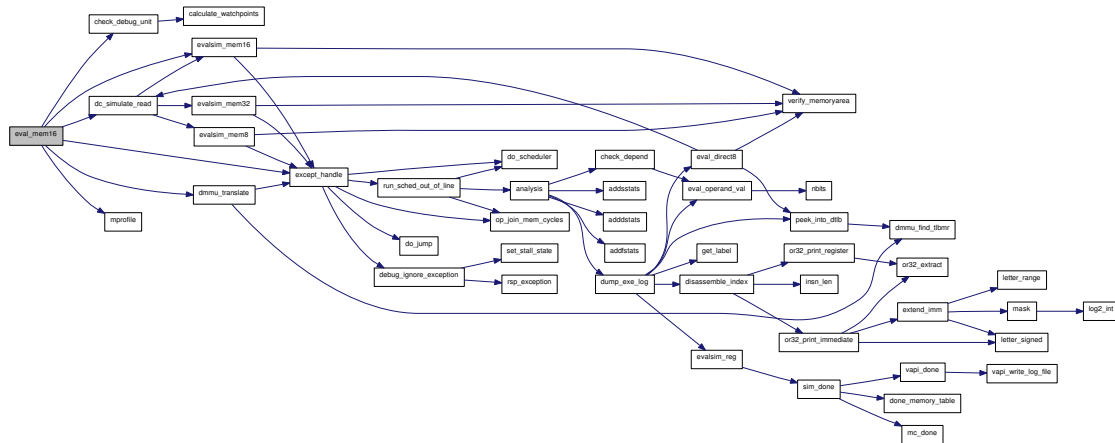

## 6.10.2.10 uint32\_t eval\_mem32 (oraddr\_t memaddr, int \*)

Here is the call graph for this function:

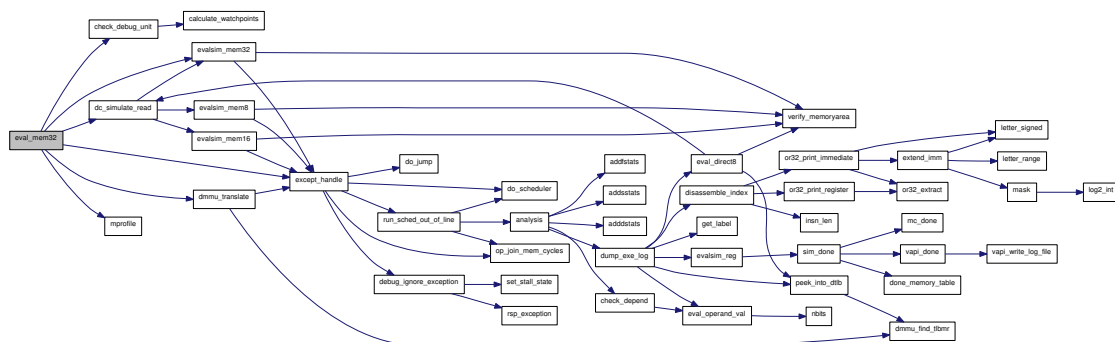

### 6.10.2.11 uint8\_t eval\_mem8 (oraddr\_t memaddr, int \*)

Here is the call graph for this function:

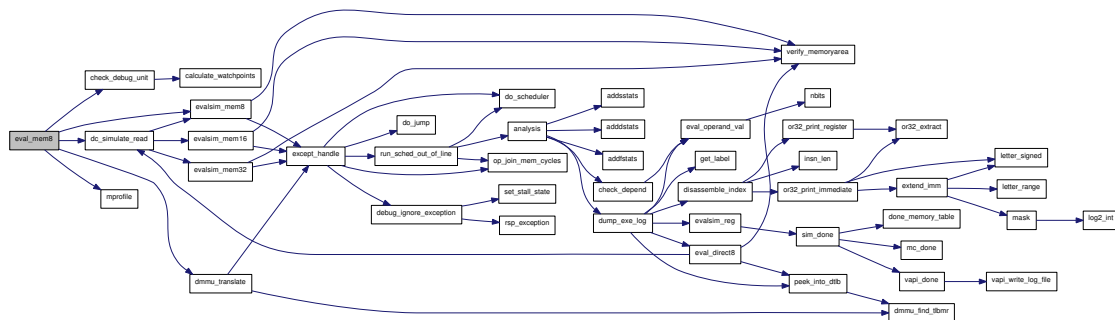

### 6.10.2.12 uint16\_t evalsim\_mem16 (oraddr\_t, oraddr\_t)

Here is the call graph for this function:

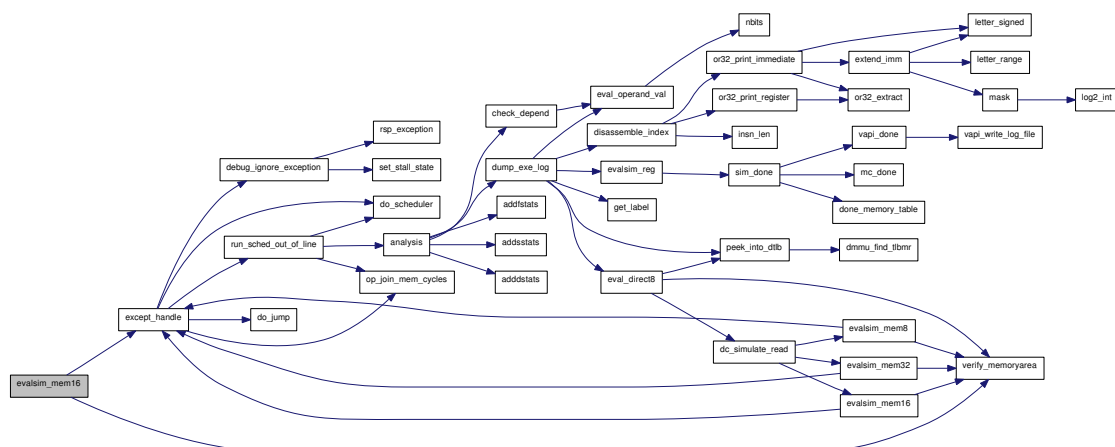

### 6.10.2.13 uint32\_t evalsim\_mem32 (oraddr\_t, oraddr\_t)

Here is the call graph for this function:

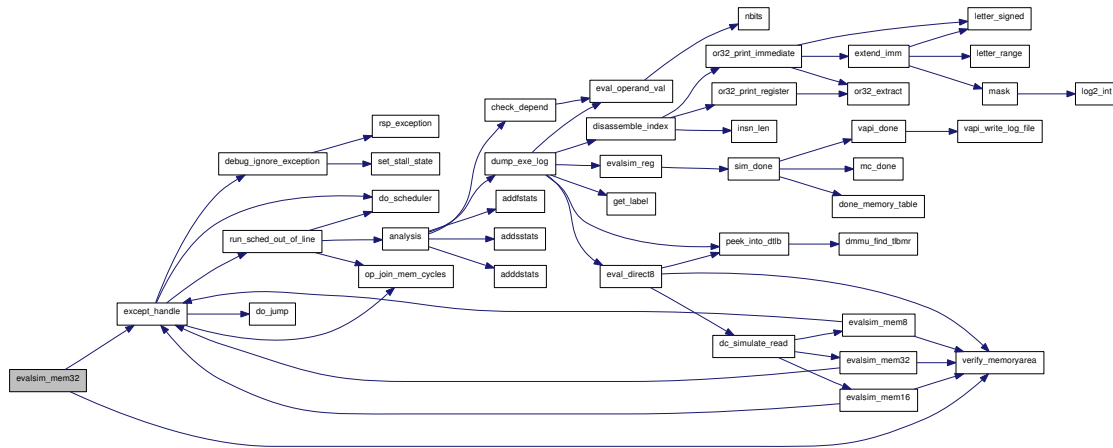

### 6.10.2.14 uint8\_t evalsim\_mem8 (oraddr\_t, oraddr\_t)

Here is the call graph for this function:

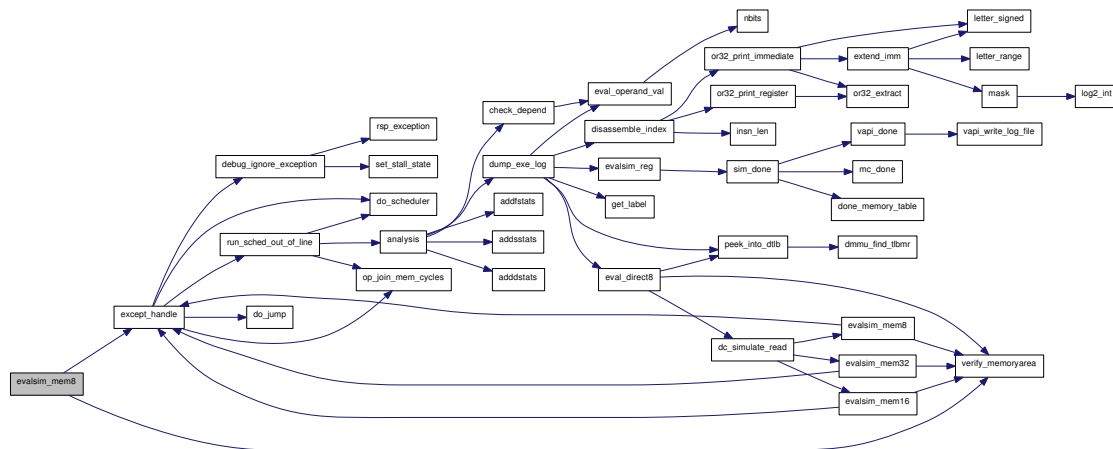

### 6.10.2.15 char\* generate\_time\_pretty (char \* dest, long time\_ps)

### 6.10.2.16 void memory\_table\_status (void)

Here is the call graph for this function:



**6.10.2.17** `struct dev_memarea* reg_mem_area (oraddr_t addr, uint32_t size, unsigned mc_dev, struct mem_ops * ops) [read]`

Here is the call graph for this function:

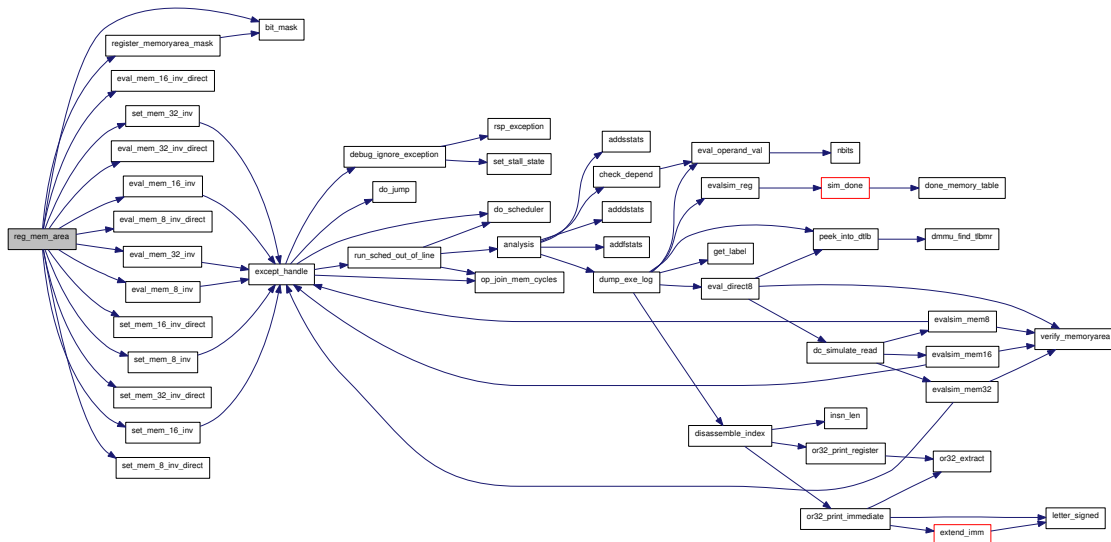

**6.10.2.18** `void set_direct16 (oraddr_t, uint16_t, int, int)`

Here is the call graph for this function:

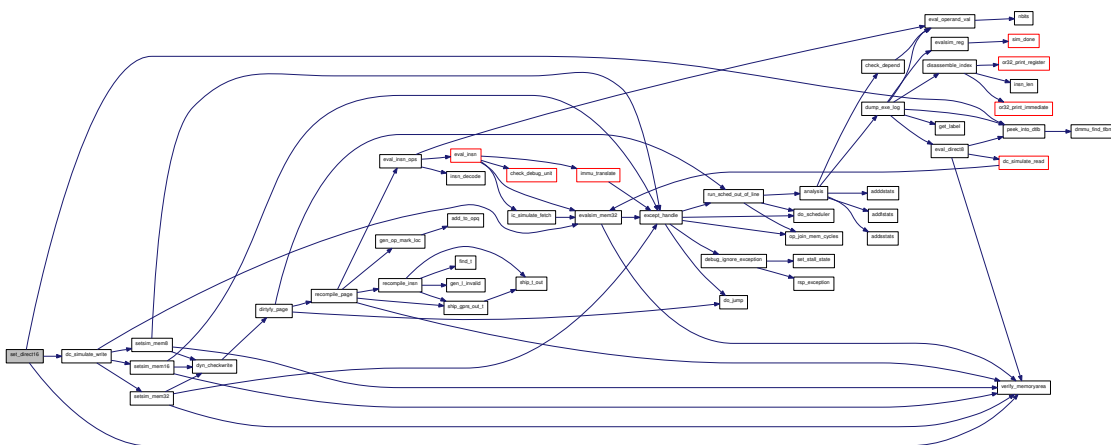

### 6.10.2.19 void set\_direct32 (oraddr\_t, uint32\_t, int, int)

Here is the call graph for this function:

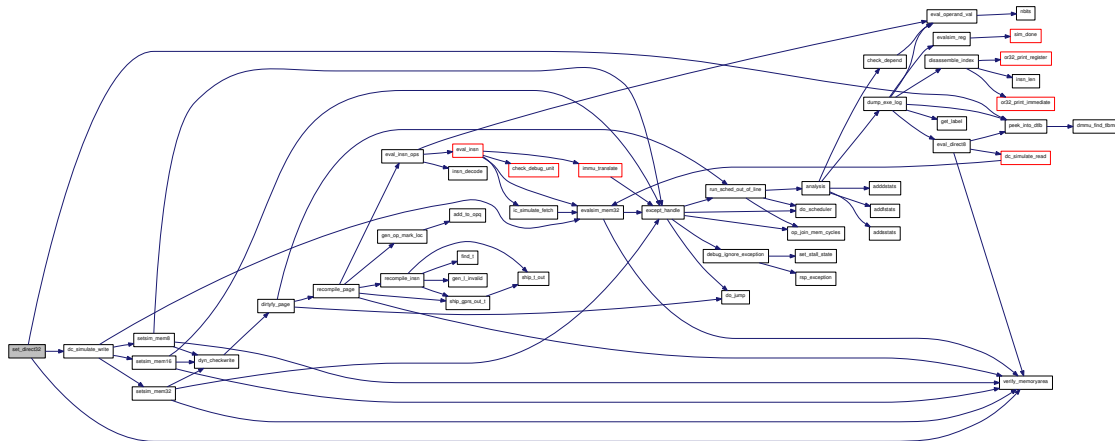

### 6.10.2.20 void set\_direct8 (oraddr\_t, uint8\_t, int, int)

Here is the call graph for this function:

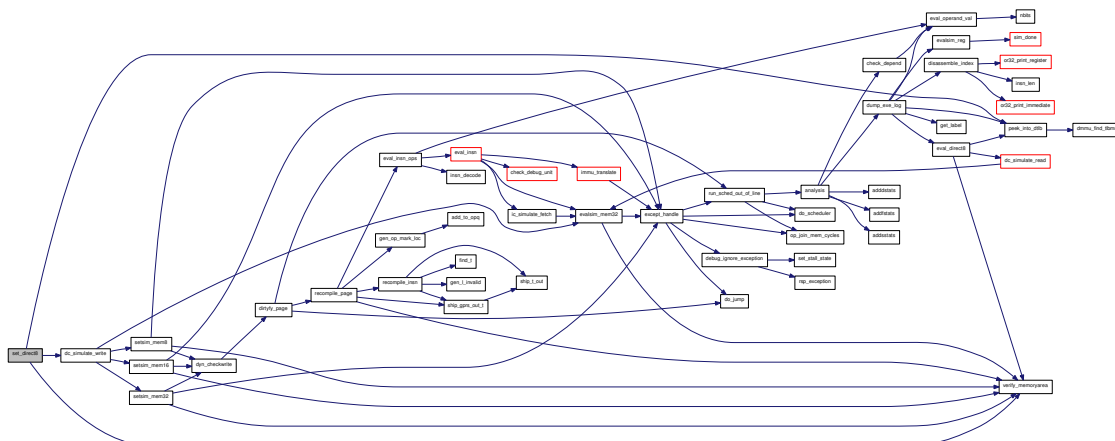





6.10.2.23 void set\_mem8 (oraddr\_t memaddr, uint8\_t value, int \*)

Here is the call graph for this function:

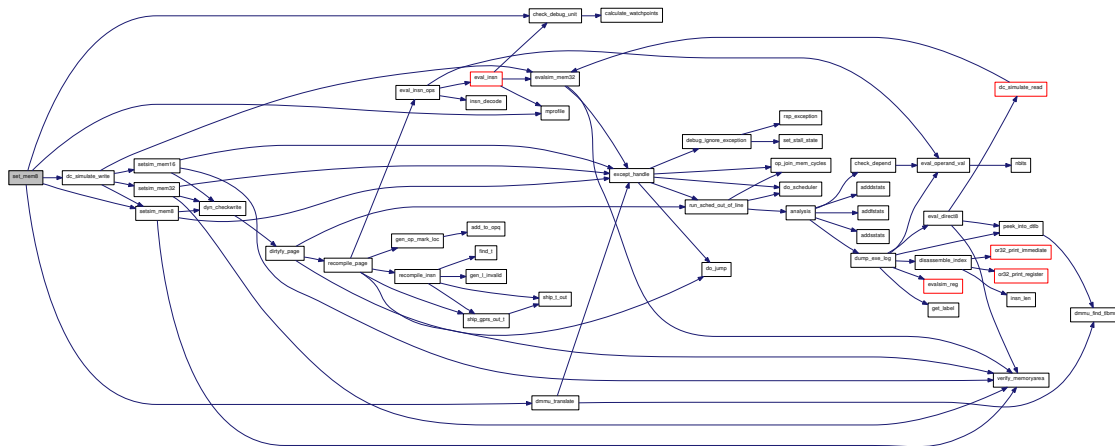

6.10.2.24 void set\_mem\_valid (struct dev\_memarea \* mem, int valid)

6.10.2.25 void set\_program32 (oraddr\_t memaddr, uint32\_t value)

Here is the call graph for this function:



6.10.2.26 void set\_program8 (oraddr\_t memaddr, uint8\_t value)

Here is the call graph for this function:





**6.10.2.30** `struct dev_memarea* verify_memoryarea (oraddr_t addr)` [read]

### 6.10.3 Variable Documentation

**6.10.3.1** `struct dev_memarea* cur_area`

Global temporary variable to increase speed.

**6.10.3.2** `int data_ci`

Global var: data cache inhibit bit set

**6.10.3.3** `struct hist_exec* hist_exec_tail`

History of execution. Globally available

**6.10.3.4** `int insn_ci`

Global var: instr cache inhibit bit set

## 6.11 cpu/common/coff.h File Reference

This graph shows which files directly or indirectly include this file:

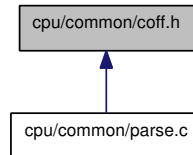

### Data Structures

- struct [COFF\\_filehdr](#)
- struct [COFF\\_AOUTHDR](#)
- struct [COFF\\_scnhdr](#)
- struct [COFF\\_slrib](#)
- struct [COFF\\_lineno](#)
- struct [COFF\\_symtab](#)
- union [COFF\\_auxent](#)
- struct [COFF\\_reloc](#)

### Defines

- #define [E\\_SYMNMLEN](#) 8
- #define [E\\_FILNMLEN](#) 14
- #define [E\\_DIMNUM](#) 4
- #define [COFF\\_SHORT\\_L](#) SWAP\_ENDIAN\_SHORT
- #define [COFF\\_LONG\\_L](#) SWAP\_ENDIAN\_LONG
- #define [COFF\\_SHORT\\_H](#) KEEP\_ENDIAN\_SHORT
- #define [COFF\\_LONG\\_H](#) KEEP\_ENDIAN\_LONG
- #define [SWAP\\_ENDIAN\\_SHORT](#)(ps)
- #define [SWAP\\_ENDIAN\\_LONG](#)(ps)
- #define [KEEP\\_ENDIAN\\_SHORT](#)(ps)
- #define [KEEP\\_ENDIAN\\_LONG](#)(ps)
- #define [COFF\\_LONG](#)(v) [COFF\\_LONG\\_L](#)(v)
- #define [COFF\\_SHORT](#)(v) [COFF\\_SHORT\\_L](#)(v)
- #define [COFF\\_F\\_RELFLG](#) 0000001
- #define [COFF\\_F\\_EXEC](#) 0000002
- #define [COFF\\_F\\_LNNO](#) 0000004
- #define [COFF\\_F\\_LSYMS](#) 0000010
- #define [COFF\\_F\\_MINMAL](#) 0000020
- #define [COFF\\_F\\_UPDATE](#) 0000040
- #define [COFF\\_F\\_SWABD](#) 0000100
- #define [COFF\\_F\\_AR16WR](#) 0000200
- #define [COFF\\_F\\_AR32WR](#) 0000400
- #define [COFF\\_F\\_AR32W](#) 0001000
- #define [COFF\\_F\\_PATCH](#) 0002000
- #define [COFF\\_F\\_NODF](#) 0002000

- #define `COFF_I386MAGIC` 0x14c
- #define `COFF_I386BADMAG(x)` (COFF\_SHORT((x).f\_magic) != COFF\_I386MAGIC)
- #define `COFF_FILHDR` struct `COFF_filehdr`
- #define `COFF_FILHSZ` sizeof(COFF\_FILHDR)
- #define `COFF_AOUTSZ` (sizeof(COFF\_AOUTHDR))
- #define `COFF_STMAGIC` 0401
- #define `COFF_OMAGIC` 0404
- #define `COFF_JMAGIC` 0407
- #define `COFF_DMAGIC` 0410
- #define `COFF_ZMAGIC` 0413
- #define `COFF_SHMAGIC` 0443
- #define `C_EFCN` 0xff
- #define `C_NULL` 0
- #define `C_AUTO` 1
- #define `C_EXT` 2
- #define `C_STAT` 3
- #define `C_REG` 4
- #define `C_EXTDEF` 5
- #define `C_LABEL` 6
- #define `C_ULABEL` 7
- #define `C_MOS` 8
- #define `C_ARG` 9
- #define `C_STRTAG` 10
- #define `C_MOU` 11
- #define `C_UNTAG` 12
- #define `C_TPDEF` 13
- #define `C_USTATIC` 14
- #define `C_ENTAG` 15
- #define `C_MOE` 16
- #define `C_REGPARAM` 17
- #define `C_FIELD` 18
- #define `C_AUTOARG` 19
- #define `C_LASTENT` 20
- #define `C_BLOCK` 100
- #define `C_FCN` 101
- #define `C_EOS` 102
- #define `C_FILE` 103
- #define `C_LINE` 104
- #define `C_ALIAS` 105
- #define `C_HIDDEN` 106
- #define `C_WEAKEXT` 127
- #define `C_UEXT` 19
- #define `C_STATLAB` 20
- #define `C_EXTLAB` 21
- #define `C_SYSTEM` 23
- #define `C_SECTION` 104
- #define `C_NT_WEAK` 105
- #define `C_LEAFPROC` 108
- #define `C_SCALL` 107
- #define `C_LEAFEXT` 108

- #define C\_LEAFSTAT 113
- #define C\_OPTVAR 109
- #define C\_DEFINE 110
- #define C\_PRAGMA 111
- #define C\_SEGMENT 112
- #define C\_SHADOW 107
- #define C\_VERSION 108
- #define C\_HIDEXT 107
- #define C\_BINCL 108
- #define C\_EINCL 109
- #define C\_GSYM (0x80)
- #define C\_LSYM (0x81)
- #define C\_PSYM (0x82)
- #define C\_RSYM (0x83)
- #define C\_RPSYM (0x84)
- #define C\_STSYM (0x85)
- #define C\_TCSYM (0x86)
- #define C\_BCOMM (0x87)
- #define C\_ECOML (0x88)
- #define C\_ECOMM (0x89)
- #define C\_DECL (0x8c)
- #define C\_ENTRY (0x8d)
- #define C\_FUN (0x8e)
- #define C\_BSTAT (0x8f)
- #define C\_ESTAT (0x90)
- #define C\_THUMBEXT (128 + C\_EXT)
- #define C\_THUMBSTAT (128 + C\_STAT)
- #define C\_THUMBLABEL (128 + C\_LABEL)
- #define C\_THUMBEXTFUNC (C\_THUMBEXT + 20)
- #define C\_THUMBSTATFUNC (C\_THUMBSTAT + 20)
- #define COFF\_SCNHDR struct COFF\_scnhdr
- #define COFF\_SCNHSZ sizeof(COFF\_SCNHDR)
- #define COFF\_TEXT ".text"
- #define COFF\_DATA ".data"
- #define COFF\_BSS ".bss"
- #define COFF\_COMMENT ".comment"
- #define COFF\_LIB ".lib"
- #define COFF\_SECT\_TEXT 0
- #define COFF\_SECT\_DATA 1
- #define COFF\_SECT\_BSS 2
- #define COFF\_SECT\_REQD 3
- #define COFF\_STYP\_REG 0x00
- #define COFF\_STYP\_DSECT 0x01
- #define COFF\_STYP\_NOLOAD 0x02
- #define COFF\_STYP\_GROUP 0x04
- #define COFF\_STYP\_PAD 0x08
- #define COFF\_STYP\_COPY 0x10
- #define COFF\_STYP\_TEXT 0x20
- #define COFF\_STYP\_DATA 0x40
- #define COFF\_STYP\_BSS 0x80

- #define `COFF_STYP_INFO` 0x200
- #define `COFF_STYP_OVER` 0x400
- #define `COFF_STYP_LIB` 0x800
- #define `COFF_SLIBHD` struct `COFF_slib`
- #define `COFF_SLIBSZ` sizeof(COFF\_SLIBHD)
- #define `COFF_LINENO` struct `COFF_lineno`
- #define `COFF_LINESZ` 6
- #define `COFF_E_SYMNMLEN` 8
- #define `COFF_E_FILNMLEN` 14
- #define `COFF_E_DIMNUM` 4
- #define `COFF_N_BTMASK` (0xf)
- #define `COFF_N_TMASK` (0x30)
- #define `COFF_N_BTSHFT` (4)
- #define `COFF_N_TSHIFT` (2)
- #define `COFF_SYMENT` struct `COFF_syment`
- #define `COFF_SYMESZ` 18
- #define `COFF_AUXENT` union `COFF_auxent`
- #define `COFF_AUXESZ` 18
- #define `COFF_ETEXT` "etext"
- #define `COFF_RELOC` struct `COFF_reloc`
- #define `COFF_RELSZ` 10
- #define `COFF_DEF_DATA_SECTION_ALIGNMENT` 4
- #define `COFF_DEF_BSS_SECTION_ALIGNMENT` 4
- #define `COFF_DEF_TEXT_SECTION_ALIGNMENT` 4
- #define `COFF_DEF_SECTION_ALIGNMENT` 4





## 6.11.1 Define Documentation

6.11.1.1 `#define C_ALIAS 105`

6.11.1.2 `#define C_ARG 9`

6.11.1.3 `#define C_AUTO 1`

6.11.1.4 `#define C_AUTOARG 19`

6.11.1.5 `#define C_BCOMM (0x87)`

6.11.1.6 `#define C_BINCL 108`

6.11.1.7 `#define C_BLOCK 100`

6.11.1.8 `#define C_BSTAT (0x8f)`

6.11.1.9 `#define C_DECL (0x8c)`

6.11.1.10 `#define C_DEFINE 110`

6.11.1.11 `#define C_ECOML (0x88)`

6.11.1.12 `#define C_ECOMM (0x89)`

6.11.1.13 `#define C_EFCN 0xff`

6.11.1.14 `#define C_EINCL 109`

6.11.1.15 `#define C_ENTAG 15`

6.11.1.16 `#define C_ENTRY (0x8d)`

6.11.1.17 `#define C_EOS 102`

6.11.1.18 `#define C_ESTAT (0x90)`

6.11.1.19 `#define C_EXT 2`

6.11.1.20 `#define C_EXTDEF 5`

6.11.1.21 `#define C_EXTLAB 21`

6.11.1.22 `#define C_FCN 101`

6.11.1.23 `#define C_FIELD 18`

6.11.1.24 `#define C_FILE 103`

6.11.1.25 `#define C_FUN (0x8e)`

6.11.1.26 `#define C_GSYM (0x80)`

6.11.1.27 `#define C_HIDDEN 106`

6.11.1.28 `#define C_HIDEXT 107`

6.11.1.29 `#define C_LABEL 6`

6.11.1.30 `#define C_LASTENT 20`

```
((long)((unsigned long)((unsigned char)ps[0])<<24) |\
      ((unsigned long)((unsigned char)ps[1])<<16) |\
      ((unsigned long)((unsigned char)ps[2])<<8)  |\
      ((unsigned long)((unsigned char)ps[3])))
```

#### 6.11.1.148 #define KEEP\_ENDIAN\_SHORT(ps)

**Value:**

```
((short)((unsigned short)((unsigned char)ps[0])<<8) |\
      ((unsigned short)((unsigned char)ps[1])))
```

#### 6.11.1.149 #define SWAP\_ENDIAN\_LONG(ps)

**Value:**

```
((long)((unsigned long)((unsigned char)ps[3])<<24) |\
      ((unsigned long)((unsigned char)ps[2])<<16) |\
      ((unsigned long)((unsigned char)ps[1])<<8)  |\
      ((unsigned long)((unsigned char)ps[0])))
```

#### 6.11.1.150 #define SWAP\_ENDIAN\_SHORT(ps)

**Value:**

```
((short)((unsigned short)((unsigned char)ps[1])<<8) |\
      ((unsigned short)((unsigned char)ps[0])))
```

## 6.12 cpu/common/elf.h File Reference

This graph shows which files directly or indirectly include this file:

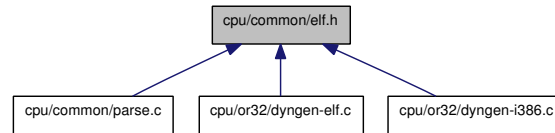

### Data Structures

- struct [dynamic](#)
- struct [Elf64\\_Dyn](#)
- struct [elf32\\_rel](#)
- struct [elf64\\_rel](#)
- struct [elf32\\_rela](#)
- struct [elf64\\_rela](#)
- struct [elf32\\_sym](#)
- struct [elf64\\_sym](#)
- struct [elf32\\_hdr](#)
- struct [elf64\\_hdr](#)
- struct [elf32\\_phdr](#)
- struct [elf64\\_phdr](#)
- struct [elf32\\_shdr](#)
- struct [elf64\\_shdr](#)
- struct [elf32\\_note](#)
- struct [elf64\\_note](#)

### Defines

- #define [ELF\\_SHORT\\_H](#)(ps)
- #define [ELF\\_LONG\\_H](#)(ps)
- #define [PT\\_NULL](#) 0
- #define [PT\\_LOAD](#) 1
- #define [PT\\_DYNAMIC](#) 2
- #define [PT\\_INTERP](#) 3
- #define [PT\\_NOTE](#) 4
- #define [PT\\_SHLIB](#) 5
- #define [PT\\_PHDR](#) 6
- #define [PT\\_LOPROC](#) 0x70000000
- #define [PT\\_HIPROC](#) 0x7fffffff
- #define [ET\\_NONE](#) 0
- #define [ET\\_REL](#) 1
- #define [ET\\_EXEC](#) 2
- #define [ET\\_DYN](#) 3
- #define [ET\\_CORE](#) 4
- #define [ET\\_LOPROC](#) 5
- #define [ET\\_HIPROC](#) 6

- #define EM\_NONE 0
- #define EM\_M32 1
- #define EM\_SPARC 2
- #define EM\_386 3
- #define EM\_68K 4
- #define EM\_88K 5
- #define EM\_486 6
- #define EM\_860 7
- #define EM\_MIPS 8
- #define EM\_MIPS\_RS4\_BE 10
- #define EM\_SPARC64 11
- #define EM\_PARISC 15
- #define EM\_SPARC32PLUS 18
- #define EM\_PPC 20
- #define EM\_ALPHA 0x9026
- #define DT\_NULL 0
- #define DT\_NEEDED 1
- #define DT\_PLTRELSZ 2
- #define DT\_PLTGOT 3
- #define DT\_HASH 4
- #define DT\_STRTAB 5
- #define DT\_SYMTAB 6
- #define DT\_RELA 7
- #define DT\_RELASZ 8
- #define DT\_RELAENT 9
- #define DT\_STRSZ 10
- #define DT\_SYMENT 11
- #define DT\_INIT 12
- #define DT\_FINI 13
- #define DT\_SONAME 14
- #define DT\_RPATH 15
- #define DT\_SYMBOLIC 16
- #define DT\_REL 17
- #define DT\_RELSZ 18
- #define DT\_RELENT 19
- #define DT\_PLTREL 20
- #define DT\_DEBUG 21
- #define DT\_TEXTREL 22
- #define DT\_JMPREL 23
- #define DT\_LOPROC 0x70000000
- #define DT\_HIPROC 0x7fffffff
- #define STB\_LOCAL 0
- #define STB\_GLOBAL 1
- #define STB\_WEAK 2
- #define STT\_NOTYPE 0
- #define STT\_OBJECT 1
- #define STT\_FUNC 2
- #define STT\_SECTION 3
- #define STT\_FILE 4
- #define ELF32\_ST\_BIND(x) ((x) >> 4)

- #define [ELF32\\_ST\\_TYPE\(x\)](#) (((unsigned int) x) & 0xf)
- #define [AT\\_NULL](#) 0
- #define [AT\\_IGNORE](#) 1
- #define [AT\\_EXECFD](#) 2
- #define [AT\\_PHDR](#) 3
- #define [AT\\_PHENT](#) 4
- #define [AT\\_PHNUM](#) 5
- #define [AT\\_PAGESZ](#) 6
- #define [AT\\_BASE](#) 7
- #define [AT\\_FLAGS](#) 8
- #define [AT\\_ENTRY](#) 9
- #define [AT\\_NOTELF](#) 10
- #define [AT\\_UID](#) 11
- #define [AT\\_EUID](#) 12
- #define [AT\\_GID](#) 13
- #define [AT\\_EGID](#) 14
- #define [ELF32\\_R\\_SYM\(x\)](#) ((x) >> 8)
- #define [ELF32\\_R\\_TYPE\(x\)](#) ((x) & 0xff)
- #define [R\\_386\\_NONE](#) 0
- #define [R\\_386\\_32](#) 1
- #define [R\\_386\\_PC32](#) 2
- #define [R\\_386\\_GOT32](#) 3
- #define [R\\_386\\_PLT32](#) 4
- #define [R\\_386\\_COPY](#) 5
- #define [R\\_386\\_GLOB\\_DAT](#) 6
- #define [R\\_386\\_JMP\\_SLOT](#) 7
- #define [R\\_386\\_RELATIVE](#) 8
- #define [R\\_386\\_GOTOFF](#) 9
- #define [R\\_386\\_GOTPC](#) 10
- #define [R\\_386\\_NUM](#) 11
- #define [R\\_68K\\_NONE](#) 0
- #define [R\\_68K\\_32](#) 1
- #define [R\\_68K\\_16](#) 2
- #define [R\\_68K\\_8](#) 3
- #define [R\\_68K\\_PC32](#) 4
- #define [R\\_68K\\_PC16](#) 5
- #define [R\\_68K\\_PC8](#) 6
- #define [R\\_68K\\_GOT32](#) 7
- #define [R\\_68K\\_GOT16](#) 8
- #define [R\\_68K\\_GOT8](#) 9
- #define [R\\_68K\\_GOT32O](#) 10
- #define [R\\_68K\\_GOT16O](#) 11
- #define [R\\_68K\\_GOT8O](#) 12
- #define [R\\_68K\\_PLT32](#) 13
- #define [R\\_68K\\_PLT16](#) 14
- #define [R\\_68K\\_PLT8](#) 15
- #define [R\\_68K\\_PLT32O](#) 16
- #define [R\\_68K\\_PLT16O](#) 17
- #define [R\\_68K\\_PLT8O](#) 18
- #define [R\\_68K\\_COPY](#) 19

- #define R\_68K\_GLOB\_DAT 20
- #define R\_68K\_JMP\_SLOT 21
- #define R\_68K\_RELATIVE 22
- #define EI\_NIDENT 16
- #define PF\_R 0x4
- #define PF\_W 0x2
- #define PF\_X 0x1
- #define SHT\_NULL 0
- #define SHT\_PROGBITS 1
- #define SHT\_SYMTAB 2
- #define SHT\_STRTAB 3
- #define SHT\_RELA 4
- #define SHT\_HASH 5
- #define SHT\_DYNAMIC 6
- #define SHT\_NOTE 7
- #define SHT\_NOBITS 8
- #define SHT\_REL 9
- #define SHT\_SHLIB 10
- #define SHT\_DYNSYM 11
- #define SHT\_NUM 12
- #define SHT\_LOPROC 0x70000000
- #define SHT\_HIPROC 0x7fffffff
- #define SHT\_LOUSER 0x80000000
- #define SHT\_HIUSER 0xffffffff
- #define SHF\_WRITE 0x1
- #define SHF\_ALLOC 0x2
- #define SHF\_EXECINSTR 0x4
- #define SHF\_MASKPROC 0xf0000000
- #define SHN\_UNDEF 0
- #define SHN\_LORESERVE 0xff00
- #define SHN\_LOPROC 0xff00
- #define SHN\_HIPROC 0xff1f
- #define SHN\_ABS 0xfff1
- #define SHN\_COMMON 0xfff2
- #define SHN\_HIRESERVE 0xffff
- #define EI\_MAG0 0
- #define EI\_MAG1 1
- #define EI\_MAG2 2
- #define EI\_MAG3 3
- #define EI\_CLASS 4
- #define EI\_DATA 5
- #define EI\_VERSION 6
- #define EI\_PAD 7
- #define ELFMAG0 0x7f
- #define ELFMAG1 'E'
- #define ELFMAG2 'L'
- #define ELFMAG3 'F'
- #define ELFMAG "\177ELF"
- #define SELFMAG 4
- #define ELFCLASSNONE 0

- #define [ELFCLASS32](#) 1
- #define [ELFCLASS64](#) 2
- #define [ELFCLASSNUM](#) 3
- #define [ELFDATANONE](#) 0
- #define [ELFDATA2LSB](#) 1
- #define [ELFDATA2MSB](#) 2
- #define [EV\\_NONE](#) 0
- #define [EV\\_CURRENT](#) 1
- #define [EV\\_NUM](#) 2
- #define [NT\\_PRSTATUS](#) 1
- #define [NT\\_PRFPREG](#) 2
- #define [NT\\_PRPSINFO](#) 3
- #define [NT\\_TASKSTRUCT](#) 4
- #define [elfhdr elf64\\_hdr](#)
- #define [elf\\_phdr elf64\\_phdr](#)
- #define [elf\\_note elf64\\_note](#)

## Typedefs

- typedef unsigned long [Elf32\\_Addr](#)
- typedef unsigned short [Elf32\\_Half](#)
- typedef unsigned long [Elf32\\_Off](#)
- typedef long [Elf32\\_Sword](#)
- typedef unsigned long [Elf32\\_Word](#)
- typedef struct [dynamic](#) [Elf32\\_Dyn](#)
- typedef struct [elf32\\_rel](#) [Elf32\\_Rel](#)
- typedef struct [elf64\\_rel](#) [Elf64\\_Rel](#)
- typedef struct [elf32\\_rela](#) [Elf32\\_Rela](#)
- typedef struct [elf64\\_rela](#) [Elf64\\_Rela](#)
- typedef struct [elf32\\_sym](#) [Elf32\\_Sym](#)
- typedef struct [elf64\\_sym](#) [Elf64\\_Sym](#)
- typedef struct [elf32\\_hdr](#) [Elf32\\_Ehdr](#)
- typedef struct [elf64\\_hdr](#) [Elf64\\_Ehdr](#)
- typedef struct [elf32\\_phdr](#) [Elf32\\_Phdr](#)
- typedef struct [elf64\\_phdr](#) [Elf64\\_Phdr](#)
- typedef struct [elf32\\_shdr](#) [Elf32\\_Shdr](#)
- typedef struct [elf64\\_shdr](#) [Elf64\\_Shdr](#)
- typedef struct [elf32\\_note](#) [Elf32\\_Nhdr](#)
- typedef struct [elf64\\_note](#) [Elf64\\_Nhdr](#)

## Variables

- [Elf64\\_Dyn \\_DYNAMIC](#) []





## 6.12.1 Define Documentation

- 6.12.1.1 `#define AT_BASE 7`
- 6.12.1.2 `#define AT_EGID 14`
- 6.12.1.3 `#define AT_ENTRY 9`
- 6.12.1.4 `#define AT_EUID 12`
- 6.12.1.5 `#define AT_EXECFD 2`
- 6.12.1.6 `#define AT_FLAGS 8`
- 6.12.1.7 `#define AT_GID 13`
- 6.12.1.8 `#define AT_IGNORE 1`
- 6.12.1.9 `#define AT_NOTELF 10`
- 6.12.1.10 `#define AT_NULL 0`
- 6.12.1.11 `#define AT_PAGESZ 6`
- 6.12.1.12 `#define AT_PHDR 3`
- 6.12.1.13 `#define AT_PHEMT 4`
- 6.12.1.14 `#define AT_PHNUM 5`
- 6.12.1.15 `#define AT_UID 11`
- 6.12.1.16 `#define DT_DEBUG 21`
- 6.12.1.17 `#define DT_FINI 13`
- 6.12.1.18 `#define DT_HASH 4`
- 6.12.1.19 `#define DT_HIPROC 0x7fffffff`
- 6.12.1.20 `#define DT_INIT 12`
- 6.12.1.21 `#define DT_JMPREL 23`
- 6.12.1.22 `#define DT_LOPROC 0x70000000`
- 6.12.1.23 `#define DT_NEEDED 1`
- 6.12.1.24 `#define DT_NULL 0`
- 6.12.1.25 `#define DT_PLTGOT 3`
- 6.12.1.26 `#define DT_PLTREL 20`
- 6.12.1.27 `#define DT_PLTRELSZ 2`
- 6.12.1.28 `#define DT_REL 17`
- 6.12.1.29 `#define DT_RELA 7`
- 6.12.1.30 `#define DT_RELAENT 9`

```
((((unsigned long) (ps) >> 24) & 0xff) |\
  ((unsigned long) (ps) >> 8) & 0xff00) |\
  ((unsigned long) (ps) << 8) & 0xff0000) |\
  ((unsigned long) (ps) << 24) & 0xff000000))
```

**6.12.1.56 #define elf\_note elf64\_note**

**6.12.1.57 #define elf\_phdr elf64\_phdr**

**6.12.1.58 #define ELF\_SHORT\_H(ps)**

**Value:**

```
((((unsigned short) (ps) >> 8) & 0xff) |\
  ((unsigned short) (ps) << 8) & 0xff00))
```



6.12.1.59 **#define** ELFCLASS32 1

6.12.1.60 **#define** ELFCLASS64 2

6.12.1.61 **#define** ELFCLASSNONE 0

6.12.1.62 **#define** ELFCLASSNUM 3

6.12.1.63 **#define** ELFDATA2LSB 1

6.12.1.64 **#define** ELFDATA2MSB 2

6.12.1.65 **#define** ELFDATANONE 0

6.12.1.66 **#define** elfhdr elf64\_hdr

6.12.1.67 **#define** ELFMAG "\177ELF"

6.12.1.68 **#define** ELFMAG0 0x7f

6.12.1.69 **#define** ELFMAG1 'E'

6.12.1.70 **#define** ELFMAG2 'L'

6.12.1.71 **#define** ELFMAG3 'F'

6.12.1.72 **#define** EM\_386 3

6.12.1.73 **#define** EM\_486 6

6.12.1.74 **#define** EM\_68K 4

6.12.1.75 **#define** EM\_860 7

6.12.1.76 **#define** EM\_88K 5

6.12.1.77 **#define** EM\_ALPHA 0x9026

6.12.1.78 **#define** EM\_M32 1

6.12.1.79 **#define** EM\_MIPS 8

6.12.1.80 **#define** EM\_MIPS\_RS4\_BE 10

6.12.1.81 **#define** EM\_NONE 0

6.12.1.82 **#define** EM\_PARISC 15

6.12.1.83 **#define** EM\_PPC 20

6.12.1.84 **#define** EM\_SPARC 2

6.12.1.85 **#define** EM\_SPARC32PLUS 18

6.12.1.86 **#define** EM\_SPARC64 41

6.12.1.87 **#define** ET\_CORE 4

6.12.1.88 **#define** ET\_DYN 3

6.12.1.89 **#define** ET\_EXEC 2

## 6.13 cpu/common/execute.h File Reference

```
#include "spr-defs.h"
#include "opcode/or32.h"
#include "abstract.h"
```

Include dependency graph for execute.h:

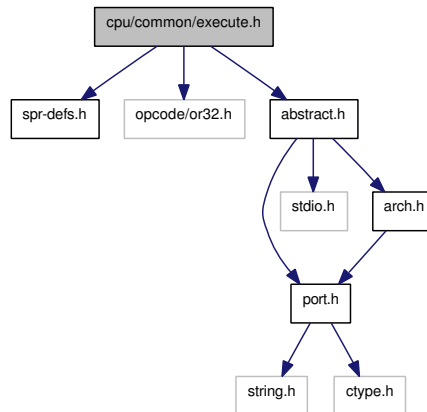

This graph shows which files directly or indirectly include this file:



### Data Structures

- struct [cpu\\_state](#)
- struct [hist\\_exec](#)

### Defines

- #define [CURINSN](#)(INSN) (strcmp(cur → [insn](#), (INSN)) == 0)
- #define [SET\\_OV\\_FLAG\\_FN](#)(value)

### Functions

- void [dumpreg](#) ()
- void [dump\\_exe\\_log](#) ()
- int [cpu\\_clock](#) ()
- void [cpu\\_reset](#) ()
- [uorreg\\_t](#) [evalsim\\_reg](#) (unsigned int regno)
- void [setsim\\_reg](#) (unsigned int regno, [uorreg\\_t](#) value)
- [uorreg\\_t](#) [eval\\_operand\\_val](#) (uint32\_t [insn](#), struct [insn\\_op\\_struct](#) \*opd)
- void [analysis](#) (struct [iqueue\\_entry](#) \*current)
- void [exec\\_main](#) ()
- int [depend\\_operands](#) (struct [iqueue\\_entry](#) \*prev, struct [iqueue\\_entry](#) \*next)

## Variables

- struct `cpu_state` `cpu_state`
- oraddr\_t `pcnext`
- int `sbuf_wait_cyc`
- int `sbuf_total_cyc`
- int `do_stats`
- struct `hist_exec` \* `hist_exec_tail`

## 6.13.1 Define Documentation

**6.13.1.1** `#define CURINSN(INSN) (strcmp(cur → insn, (INSN)) == 0)`

**6.13.1.2** `#define SET_OV_FLAG_FN(value)`

Sets a new `SPR_SR_OV` value, based on next register value

## 6.13.2 Function Documentation

**6.13.2.1** `void analysis (struct iqueue_entry * current)`

Perform analysis of the instruction being executed

This could be static for `SIMPLE_EXECUTION`, but made global for general use.

### Parameters:

← *current* The instruction being executed

Here is the call graph for this function:

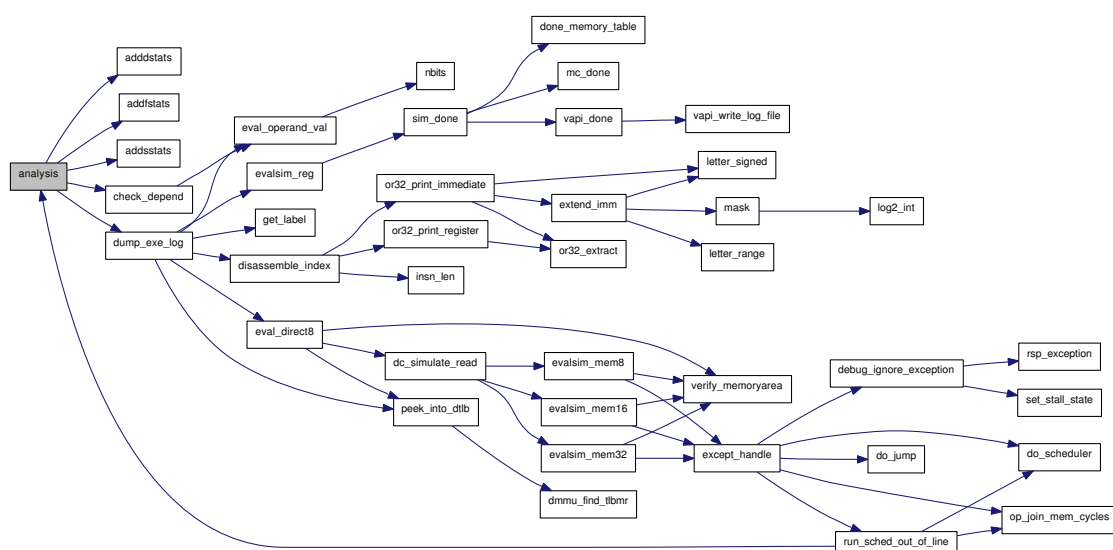

### 6.13.2.2 int cpu\_clock ()

Simulates one CPU clock cycle

**Returns:**

non-zero if a breakpoint is hit, zero otherwise.

Here is the call graph for this function:

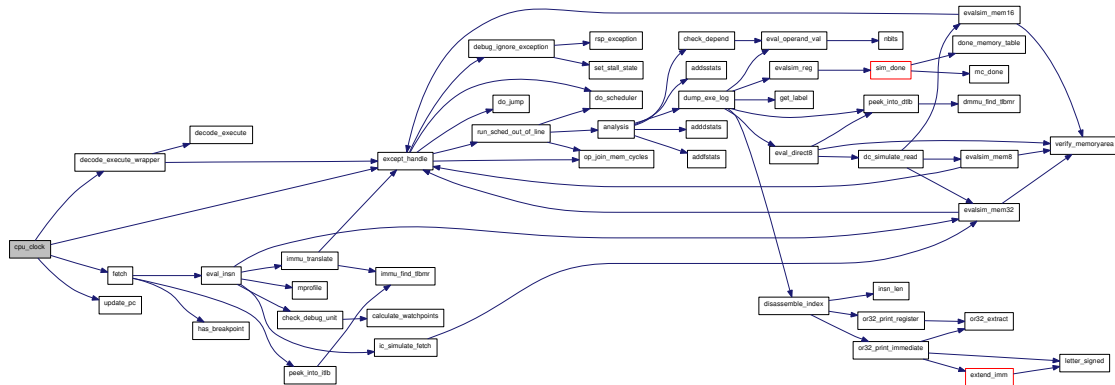

### 6.13.2.3 void cpu\_reset ()

Reset the CPU

Here is the call graph for this function:

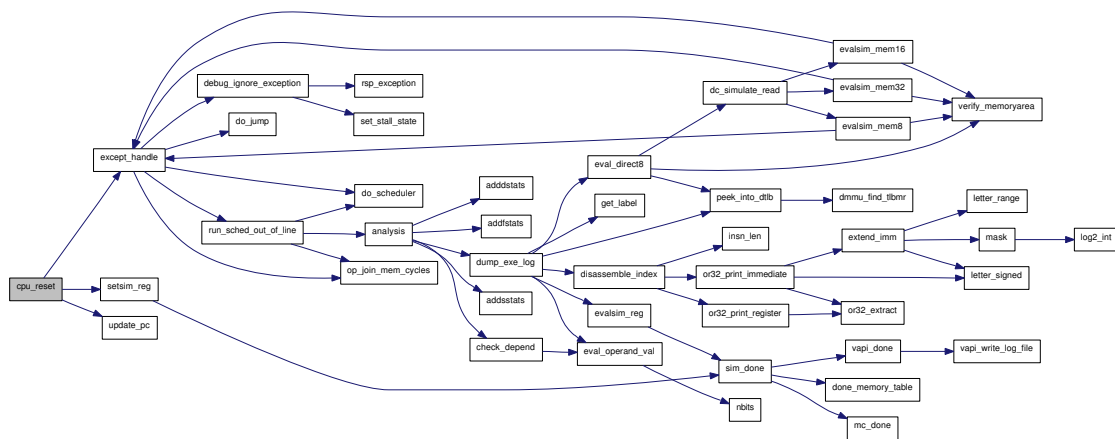

### 6.13.2.4 int depend\_operands (struct iqueue\_entry \* prev, struct iqueue\_entry \* next)

### 6.13.2.5 void dump\_exe\_log ()

Outputs disassembled instruction

Here is the call graph for this function:

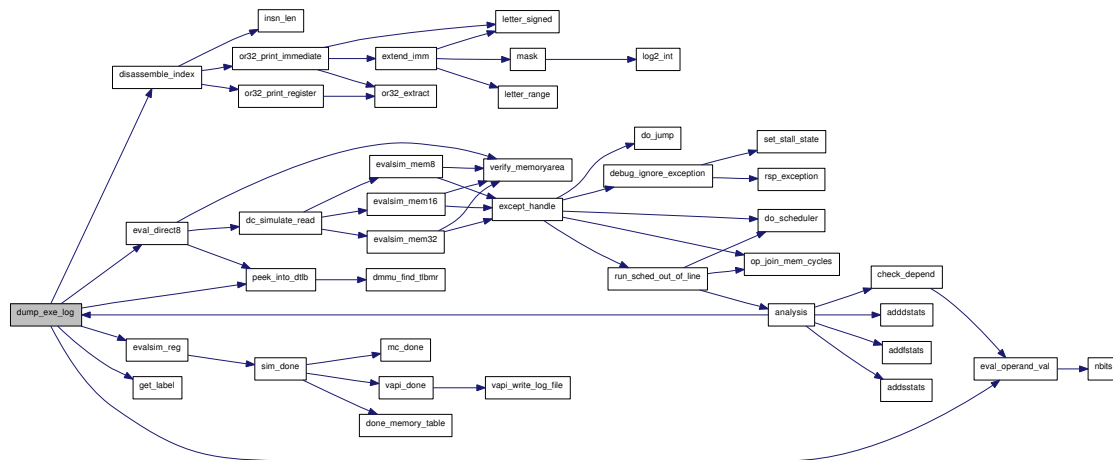

### 6.13.2.6 void dumpreg ()

Dump registers

Supports the CLI 'r' and 't' commands

Here is the call graph for this function:

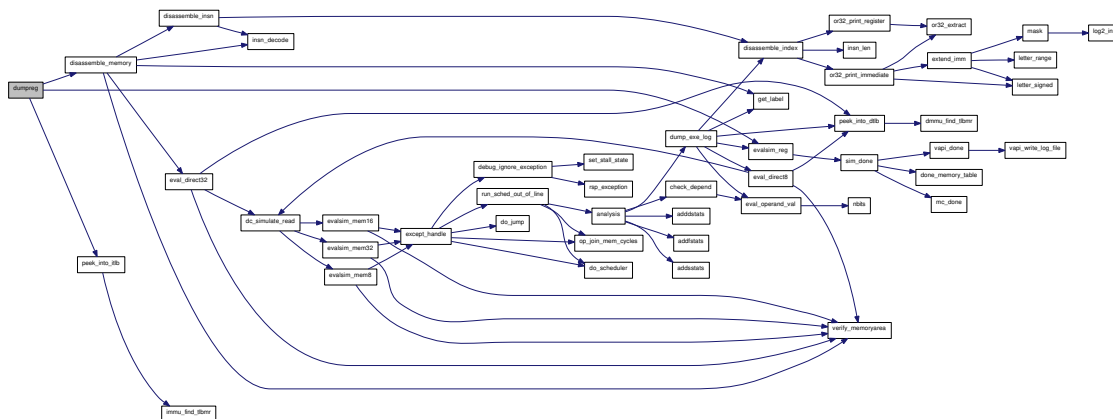

### 6.13.2.7 uorreg\_t eval\_operand\_val (uint32\_t insn, struct insn\_op\_struct \* opd)

Evaluates source operand operand

Implementation specific. Declared global, although this is only actually required for DYNAMIC\_EXECUTION,

**Parameters:**

← *insn* The instruction

← *opd* The operand



**Returns:**

The value of the source operand

Here is the call graph for this function:

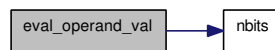
**6.13.2.8 uorreg\_t evalsim\_reg (unsigned int regno)**

Get an actual value of a specific register

Implementation specific. Abort if we are given a duff register. Only used externally to support [simprintf\(\)](#).

**Parameters:**

← *regno* The register of interest

**Returns:**

The value of the register

Here is the call graph for this function:

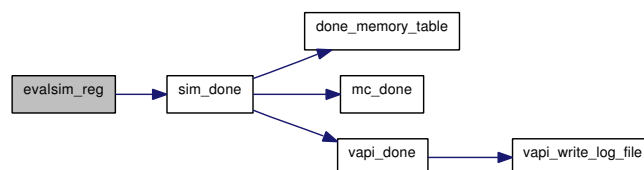
**6.13.2.9 void exec\_main ()**

The main execution loop

Here is the call graph for this function:

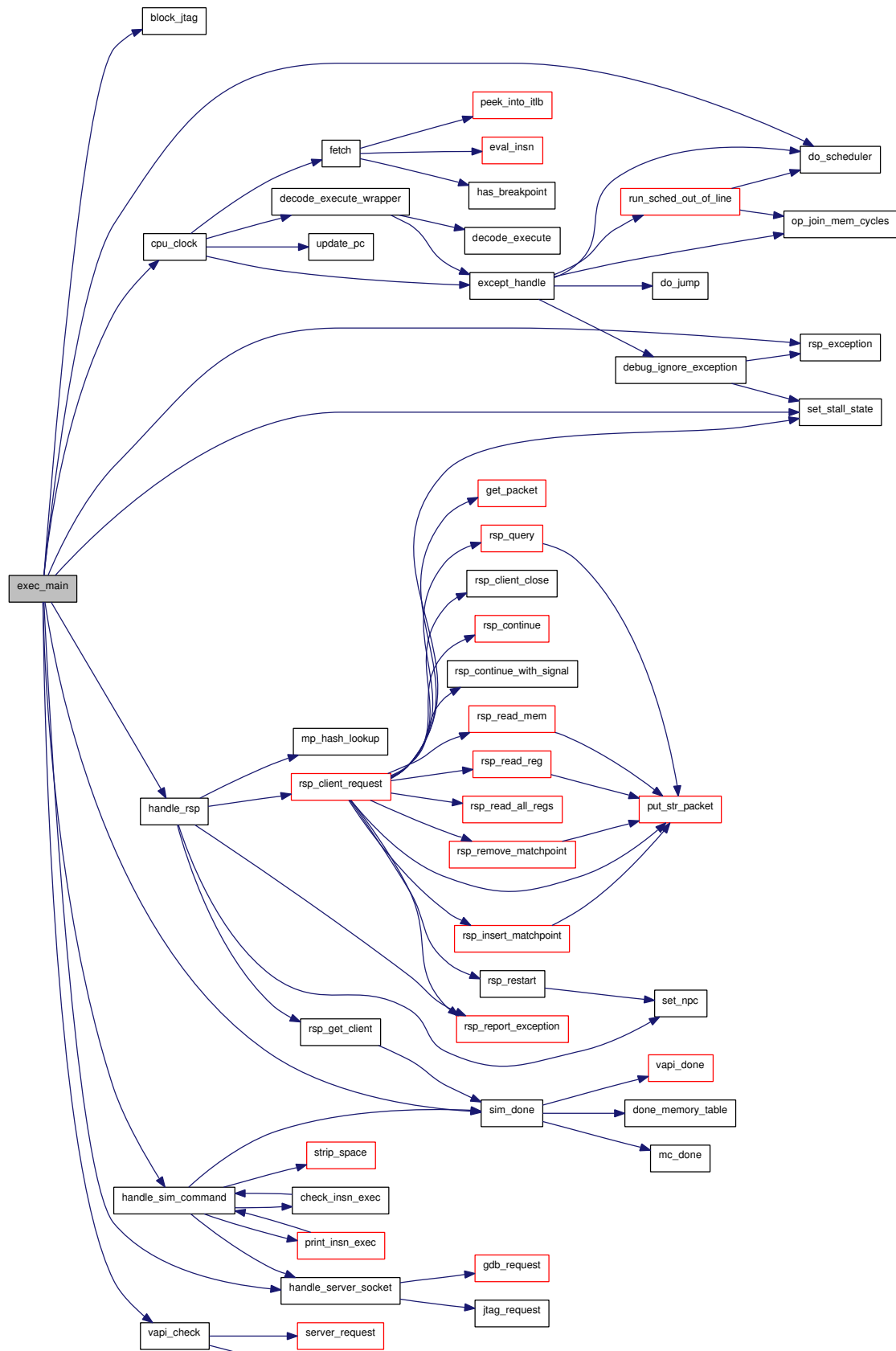

**6.13.2.10 void setsim\_reg (unsigned int regno, uorreg\_t value)**

Set a specific register with value

Implementation specific. Abort if we are given a duff register.

**Parameters:**

← *regno* The register of interest

← *value* The value to be set

Here is the call graph for this function:

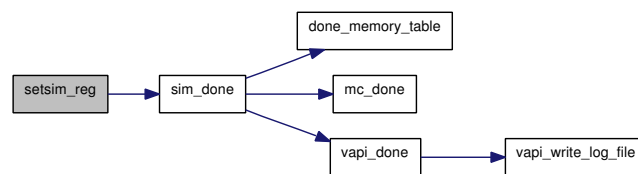
**6.13.3 Variable Documentation****6.13.3.1 struct cpu\_state cpu\_state**

Current cpu state. Globally available.

**6.13.3.2 int do\_stats**

Whether we are doing statistical analysis. Globally available

**6.13.3.3 struct hist\_exec\* hist\_exec\_tail**

History of execution. Globally available

**6.13.3.4 oraddr\_t pcnext**

Temporary program counter. Globally available

**6.13.3.5 int sbuf\_total\_cyc**

Number of total store cycles. Globally available

**6.13.3.6 int sbuf\_wait\_cyc**

Num cycles waiting for stores to complete. Globally available

## 6.14 cpu/common/labels.c File Reference

```
#include "config.h"
#include "port.h"
#include <stdlib.h>
#include "labels.h"
```

Include dependency graph for labels.c:

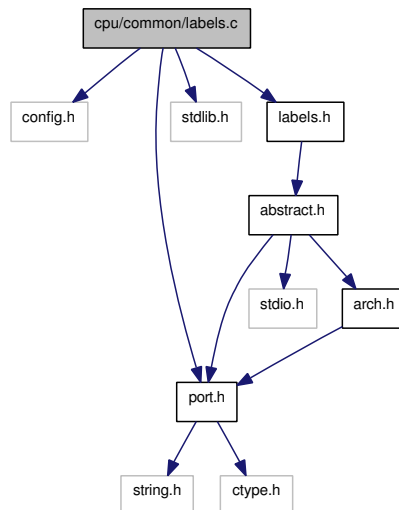

### Defines

- `#define LABELS_HASH_SIZE 119`

### Functions

- `void init_labels ()`
- `void add_label (oraddr_t addr, char *name)`
- `struct label_entry * get_label (oraddr_t addr)`
- `struct label_entry * find_label (char *name)`
- `oraddr_t eval_label (char *name)`
- `void init_breakpoints ()`
- `void add_breakpoint (oraddr_t addr)`
- `void remove_breakpoint (oraddr_t addr)`
- `void print_breakpoints ()`
- `int has_breakpoint (oraddr_t addr)`

### Variables

- `struct breakpoint_entry * breakpoints`
- `static struct label_entry * label_hash [LABELS_HASH_SIZE]`

## 6.14.1 Define Documentation

6.14.1.1 `#define LABELS_HASH_SIZE 119`

## 6.14.2 Function Documentation

6.14.2.1 `void add_breakpoint (oraddr_t addr)`

6.14.2.2 `void add_label (oraddr_t addr, char * name)`

6.14.2.3 `oraddr_t eval_label (char * name)`

Here is the call graph for this function:



6.14.2.4 `struct label_entry* find_label (char * name)` [read]

6.14.2.5 `struct label_entry* get_label (oraddr_t addr)` [read]

6.14.2.6 `int has_breakpoint (oraddr_t addr)`

6.14.2.7 `void init_breakpoints ()`

6.14.2.8 `void init_labels ()`

6.14.2.9 `void print_breakpoints ()`

6.14.2.10 `void remove_breakpoint (oraddr_t addr)`

## 6.14.3 Variable Documentation

6.14.3.1 `struct breakpoint_entry* breakpoints`

6.14.3.2 `struct label_entry* label_hash[LABELS_HASH_SIZE]` [static]

## 6.15 cpu/common/labels.h File Reference

```
#include "abstract.h"
```

Include dependency graph for labels.h:

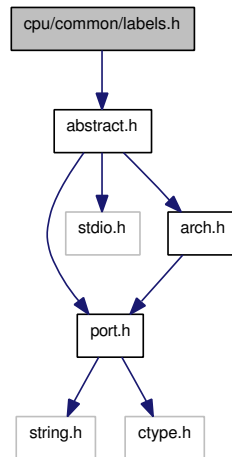

This graph shows which files directly or indirectly include this file:

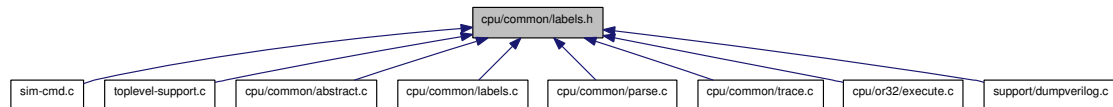

### Data Structures

- struct [label\\_entry](#)
- struct [breakpoint\\_entry](#)

### Functions

- void [init\\_labels](#) ()
- void [add\\_label](#) ([oraddr\\_t](#) addr, char \*name)
- struct [label\\_entry](#) \* [get\\_label](#) ([oraddr\\_t](#) addr)
- struct [label\\_entry](#) \* [find\\_label](#) (char \*name)
- [oraddr\\_t](#) [eval\\_label](#) (char \*name)
- void [add\\_breakpoint](#) ([oraddr\\_t](#) addr)
- void [remove\\_breakpoint](#) ([oraddr\\_t](#) addr)
- void [print\\_breakpoints](#) ()
- int [has\\_breakpoint](#) ([oraddr\\_t](#) addr)
- void [init\\_breakpoints](#) ()

### Variables

- struct [breakpoint\\_entry](#) \* [breakpoints](#)

## 6.15.1 Function Documentation

**6.15.1.1** void `add_breakpoint` (`oraddr_t addr`)

**6.15.1.2** void `add_label` (`oraddr_t addr`, `char * name`)

**6.15.1.3** `oraddr_t eval_label` (`char * name`)

Here is the call graph for this function:



**6.15.1.4** `struct label_entry*` `find_label` (`char * name`) [read]

**6.15.1.5** `struct label_entry*` `get_label` (`oraddr_t addr`) [read]

**6.15.1.6** int `has_breakpoint` (`oraddr_t addr`)

**6.15.1.7** void `init_breakpoints` ()

**6.15.1.8** void `init_labels` ()

**6.15.1.9** void `print_breakpoints` ()

**6.15.1.10** void `remove_breakpoint` (`oraddr_t addr`)

## 6.15.2 Variable Documentation

**6.15.2.1** `struct breakpoint_entry*` `breakpoints`

## 6.16 cpu/common/parse.c File Reference

```
#include "config.h"
#include "port.h"
#include <stdlib.h>
#include "parse.h"
#include "sim-config.h"
#include "debug.h"
#include "abstract.h"
#include "opcode/or32.h"
#include "coff.h"
#include "elf.h"
#include "labels.h"
```

Include dependency graph for parse.c:

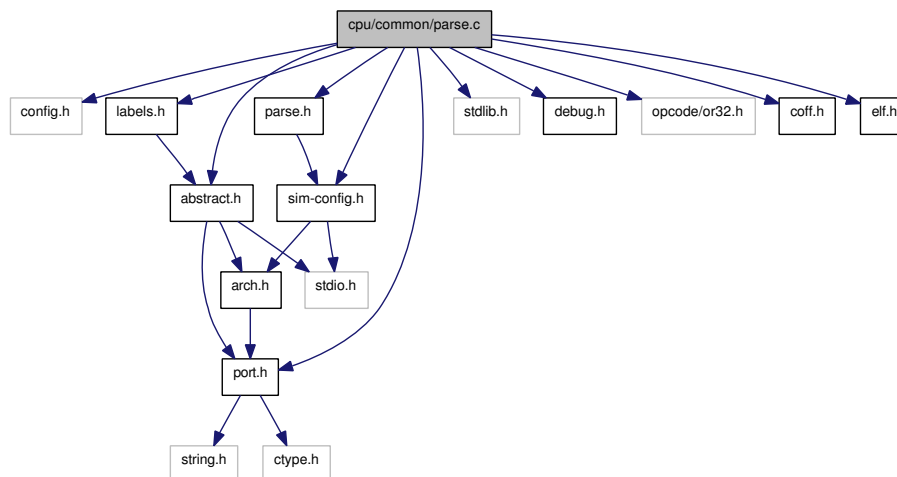

### Defines

- #define [MEMORY\\_LEN](#) 0x100000000ULL
- #define [IMM\\_STATS](#) 0

### Functions

- char \* [rstrip](#) (char \*dst, const char \*src, int n)
- static [oraddr\\_t](#) [translate](#) ([oraddr\\_t](#) laddr, int \*breakpoint)
- static void [addprogram](#) ([oraddr\\_t](#) address, [uint32\\_t](#) insn, int \*breakpoint)
- static void [readfile\\_coff](#) (char \*filename, short sections)
- static void [readsyms\\_coff](#) (char \*filename, [uint32\\_t](#) symptr, [uint32\\_t](#) syms)
- static void [readfile\\_elf](#) (char \*filename)
- static void [identifyfile](#) (char \*filename)
- [uint32\\_t](#) [loadcode](#) (char \*filename, [oraddr\\_t](#) startaddr, [oraddr\\_t](#) virtphy\_transl)



## Variables

- static unsigned int [freemem](#)
- static [oraddr\\_t](#) [transl\\_table](#)
- static [uint32\\_t](#) [transl\\_error](#)

## 6.16.1 Define Documentation

### 6.16.1.1 #define IMM\_STATS 0

Whether to do immediate statistics. This seems to be for local debugging of [parse.c](#)

### 6.16.1.2 #define MEMORY\_LEN 0x10000000ULL

## 6.16.2 Function Documentation

### 6.16.2.1 static void [addprogram](#) ([oraddr\\_t](#) *address*, [uint32\\_t](#) *insn*, [int](#) \**breakpoint*) [static]

Add an instruction to the program

#### Note:

*insn* must be in big endian format

#### Parameters:

- ← *address* The address to use
- ← *insn* The instruction to add
- ← *breakpoint* Not used (it is passed to the [translate\(\)](#) function, which also does not use it.

Here is the call graph for this function:

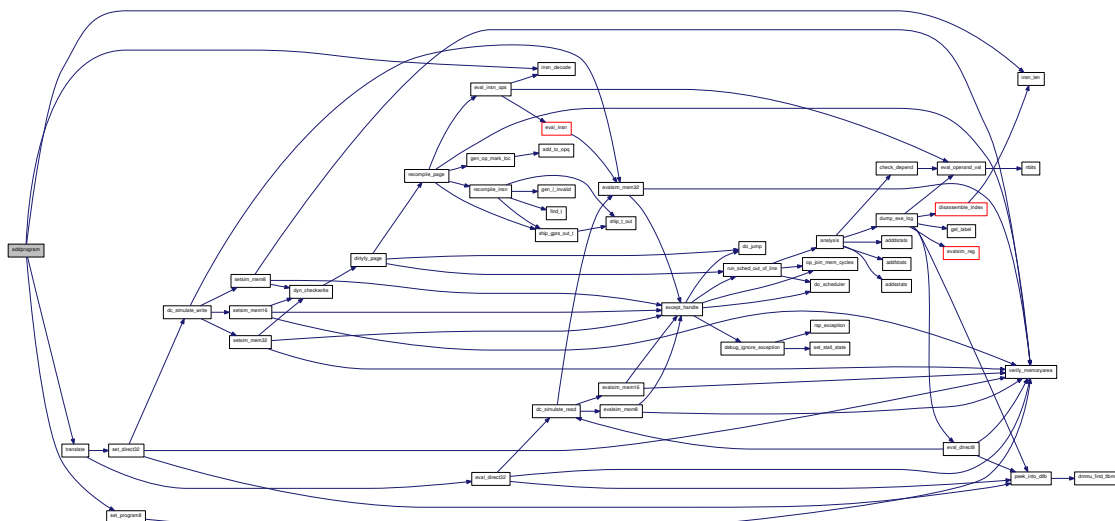

### 6.16.2.2 static void identifyfile (char \*filename) [static]

Here is the call graph for this function:

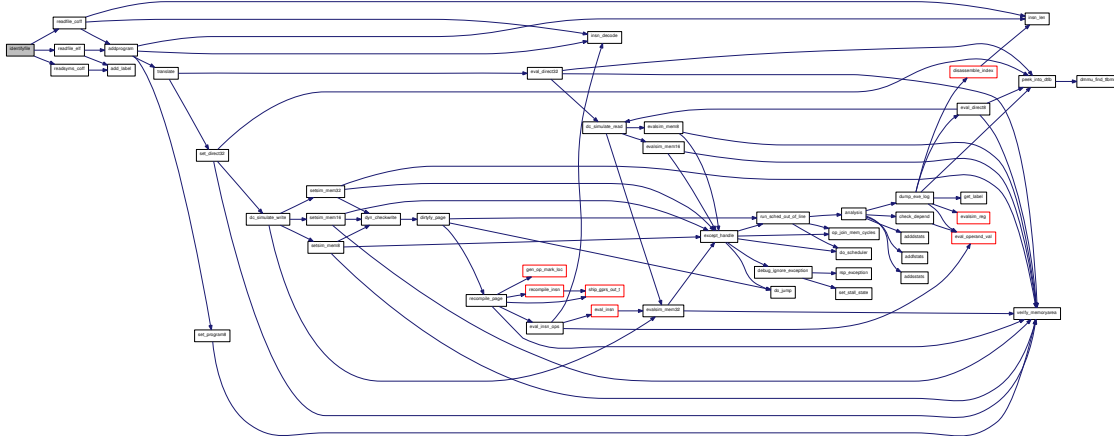

### 6.16.2.3 uint32\_t loadcode (char \*filename, oraddr\_t startaddr, oraddr\_t virtphy\_transl)

Load file to memory

Loads file to memory starting at address startaddr and returns freemem.

#### Parameters:

← *filename* File to load

← *startaddr* Start address at which to load

← *virtphy\_transl* Virtual to physical translation table if required. Only used for microkernel simulation, and not used in Ork1sim at present (set to NULL)

#### Returns:

zero on success, negative on failure.

Here is the call graph for this function:

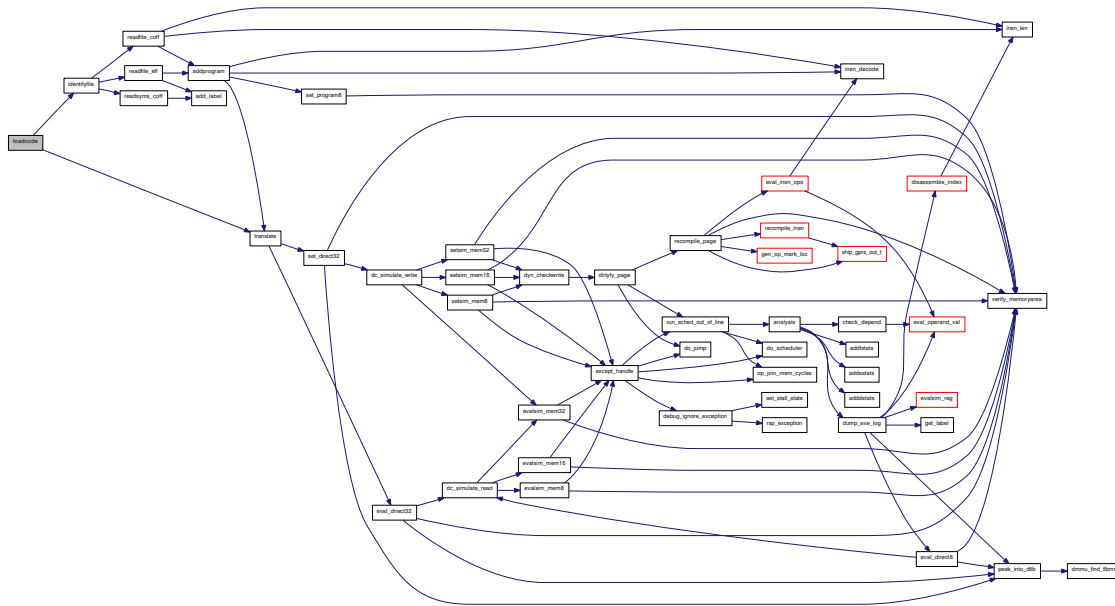

**6.16.2.4 static void readfile\_coff (char \*filename, short sections) [static]**

Load big-endian COFF file

**Parameters:**

- ← *filename* File to load
- ← *sections* Number of sections in file

Here is the call graph for this function:

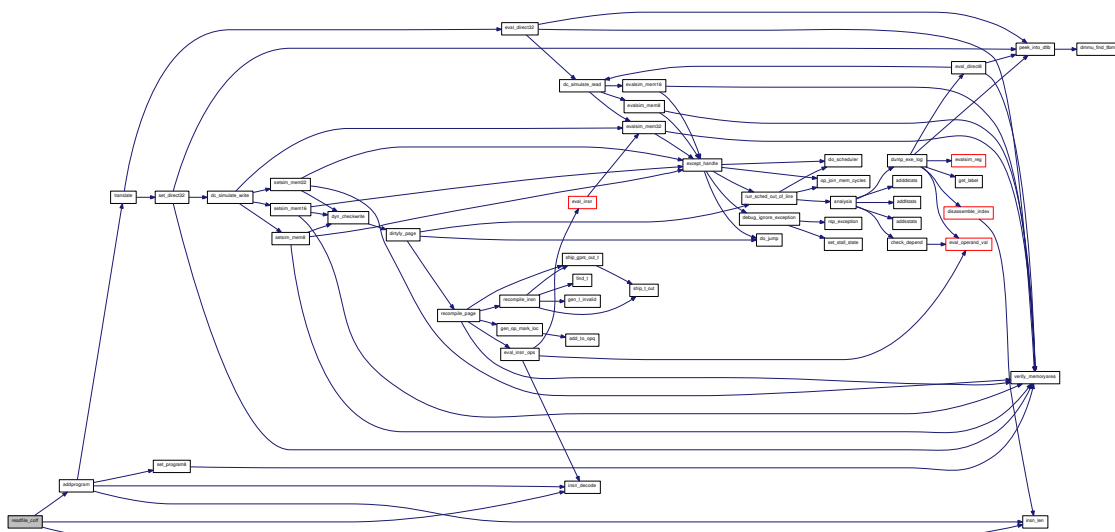

### 6.16.2.5 static void readfile\_elf (char \*filename) [static]

Here is the call graph for this function:

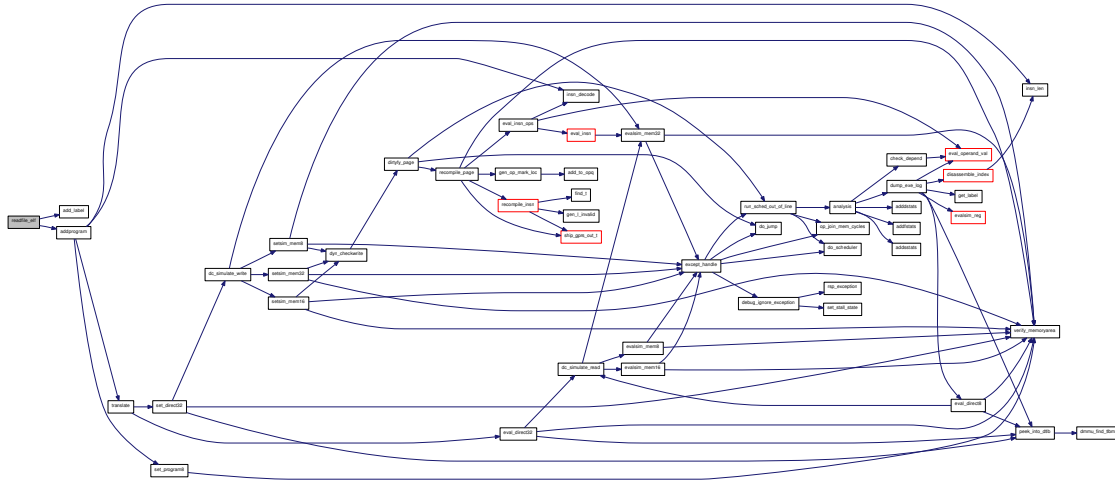

### 6.16.2.6 static void readsyms\_coff (char \*filename, uint32\_t symptr, uint32\_t syms) [static]

Here is the call graph for this function:



### 6.16.2.7 char\* strstrip (char \*dst, const char \*src, int n)

Copy a string with null termination

This function is very similar to strncpy, except it null terminates the string. A global function also used by the CUC.

#### Parameters:

- ← *dst* The destination string
- ← *src* The source string
- ← *n* Number of chars to copy EXCLUDING the null terminator (i.e. dst had better have room for n+1 chars)

#### Returns:

A pointer to dst

### 6.16.2.8 static oraddr\_t translate (oraddr\_t laddr, int \*breakpoint) [static]

Translate logical to physical addresses for the loader

Used only by the simulator loader to translate logical addresses into physical. If `loadcode()` is called with valid `virtphy_transl` pointer to a table of translations then `translate()` performs translation otherwise physical address is equal to logical.

#### Parameters:

- ← *laddr* Logical address
- ← *breakpoint* Unused

#### Returns:

The physical address

Here is the call graph for this function:

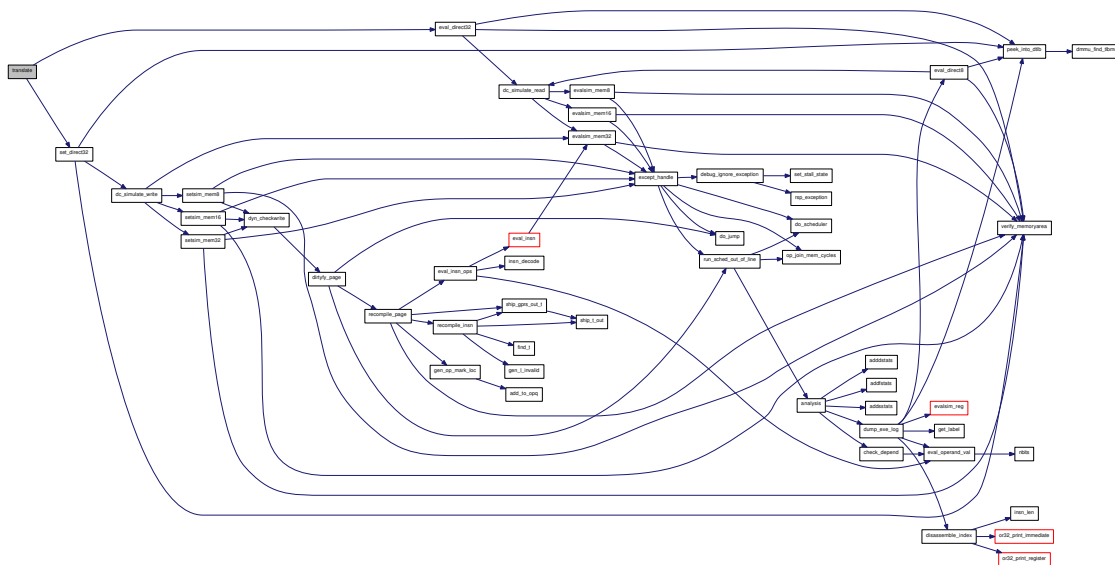

## 6.16.3 Variable Documentation

### 6.16.3.1 unsigned int freemem [static]

Unused mem memory marker. It is used when allocating program and data memory during parsing

### 6.16.3.2 uint32\_t transl\_error [static]

Used to signal whether during loading of programs a translation fault occurred.

### 6.16.3.3 oraddr\_t transl\_table [static]

Translation table provided by microkernel. Only used if simulating microkernel.

## 6.17 cpu/common/parse.h File Reference

```
#include "sim-config.h"
```

Include dependency graph for parse.h:

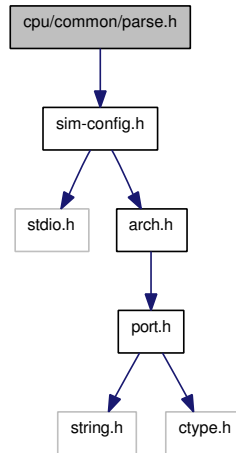

This graph shows which files directly or indirectly include this file:

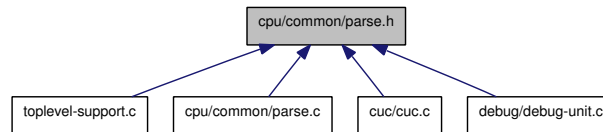

### Functions

- char \* [rstrip](#) (char \*dst, const char \*src, int n)
- uint32\_t [loadcode](#) (char \*filename, [oraddr\\_t](#) startaddr, [oraddr\\_t](#) virtphy\_transl)

### 6.17.1 Function Documentation

#### 6.17.1.1 uint32\_t loadcode (char \*filename, oraddr\_t startaddr, oraddr\_t virtphy\_transl)

Load file to memory

Loads file to memory starting at address startaddr and returns freemem.

#### Parameters:

- ← *filename* File to load
- ← *startaddr* Start address at which to load
- ← *virtphy\_transl* Virtual to physical transation table if required. Only used for microkernel simulation, and not used in Ork1sim at present (set to NULL)

#### Returns:

zero on success, negative on failure.



## 6.18 cpu/common/stats.c File Reference

```
#include "config.h"
#include "port.h"
#include "stats.h"
#include "sim-config.h"
#include "icache-model.h"
#include "spr-defs.h"
#include "execute.h"
```

Include dependency graph for stats.c:

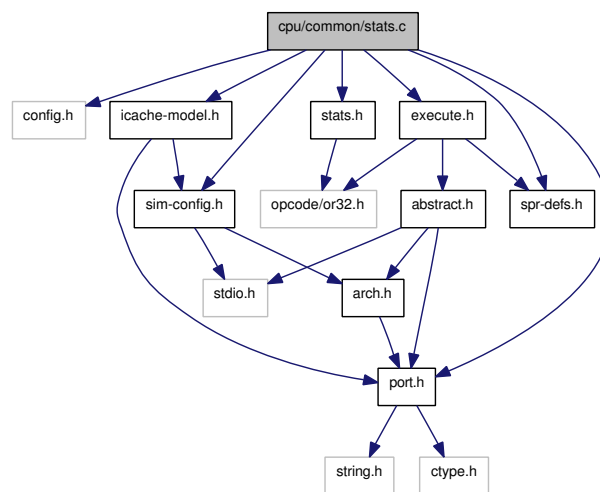

### Data Structures

- struct [branchstat](#)
- struct [dstats\\_entry](#)
- struct [sstats\\_entry](#)
- struct [fstats\\_entry](#)

### Defines

- #define [DSTATS\\_LEN](#) 3000
- #define [SSTATS\\_LEN](#) 300
- #define [FSTATS\\_LEN](#) 200
- #define [SD\(X\)](#) (X != 0 ? X : 1)

### Functions

- void [addsstats](#) (int item, int cnt\_dynamic)
- void [adddstats](#) (int item1, int item2, int cnt\_dynamic, int depend)
- void [addfstats](#) (enum insn\_type item1, enum insn\_type item2, int cnt\_dynamic, int depend)



- void `initstats` ()
- static void `printotherstats` (int *which*)
- void `printstats` (int *which*)

## Variables

- static const char `func_unit_str` [30][30]
- struct `mstats_entry` or `lk_mstats` = { 0 }
- struct `cachestats_entry` `ic_stats` = { 0 }
- struct `cachestats_entry` `dc_stats` = { 0 }
- struct `immustats_entry` `immu_stats` = { 0 }
- struct `dmmustats_entry` `dmmu_stats` = { 0 }
- struct `raw_stats` `raw_stats`
- static struct `dstats_entry` `dstats` [DSTATS\_LEN]
- static struct `sstats_entry` `sstats` [SSTATS\_LEN]
- static struct `fstats_entry` `fstats` [FSTATS\_LEN]

### 6.18.1 Define Documentation

6.18.1.1 `#define DSTATS_LEN 3000`

6.18.1.2 `#define FSTATS_LEN 200`

6.18.1.3 `#define SD(X) (X != 0 ? X : 1)`

6.18.1.4 `#define SSTATS_LEN 300`

### 6.18.2 Function Documentation

6.18.2.1 void `adddstats` (int *item1*, int *item2*, int *cnt\_dynamic*, int *depend*)

6.18.2.2 void `addfstats` (enum *insn\_type item1*, enum *insn\_type item2*, int *cnt\_dynamic*, int *depend*)

6.18.2.3 void `addsstats` (int *item*, int *cnt\_dynamic*)

6.18.2.4 void `initstats` ()

6.18.2.5 static void `printotherstats` (int *which*) [static]

6.18.2.6 void `printstats` (int *which*)

Here is the call graph for this function:

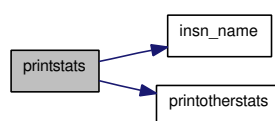

### 6.18.3 Variable Documentation

#### 6.18.3.1 struct cachestats\_entry dc\_stats = { 0 }

data cache stats

#### 6.18.3.2 struct dmmustats\_entry dmmu\_stats = { 0 }

data MMU stats

#### 6.18.3.3 struct dstats\_entry dstats[DSTATS\_LEN] [static]

dependency stats

#### 6.18.3.4 struct fstats\_entry fstats[FSTATS\_LEN] [static]

func units stats

#### 6.18.3.5 const char func\_unit\_str[30][30] [static]

##### Initial value:

```
{
  "unknown",
  "exception",
  "arith",
  "shift",
  "compare",
  "branch",
  "jump",
  "load",
  "store",
  "movimm",
  "move",
  "extend",
  "nop",
  "mac"
}
```

##### See also:

also enum `insn_type` in [abstract.h](#)

#### 6.18.3.6 struct cachestats\_entry ic\_stats = { 0 }

instruction cache stats

#### 6.18.3.7 struct immustats\_entry immu\_stats = { 0 }

insn MMU stats

**6.18.3.8 struct mstats\_entry or1k\_mstats = { 0 }**

misc units stats

**6.18.3.9 struct raw\_stats raw\_stats**

RAW hazard stats

**6.18.3.10 struct sstats\_entry sstats[SSTATS\_LEN] [static]**

single stats

## 6.19 cpu/common/stats.h File Reference

```
#include "opcode/or32.h"
```

Include dependency graph for stats.h:

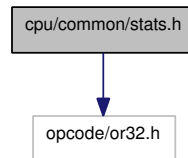

This graph shows which files directly or indirectly include this file:

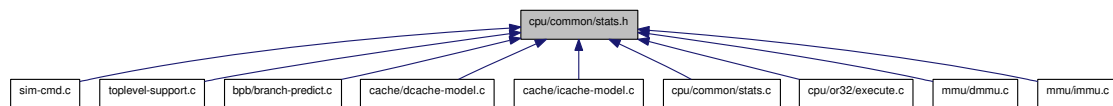

### Data Structures

- struct [bpbstat](#)
- struct [bticstat](#)
- struct [mstats\\_entry](#)
- struct [cachestats\\_entry](#)
- struct [immustats\\_entry](#)
- struct [dmmustats\\_entry](#)
- struct [raw\\_stats](#)

### Defines

- #define [RAW\\_RANGE](#) 1000

### Functions

- void [addsstats](#) (int item, int cnt\_dynamic)
- void [adddstats](#) (int item1, int item2, int cnt\_dynamic, int depend)
- void [addfstats](#) (enum insn\_type item1, enum insn\_type item2, int cnt\_dynamic, int depend)
- void [initstats](#) ()
- void [printstats](#) ()

### Variables

- struct [mstats\\_entry](#) [or1k\\_mstats](#)
- struct [cachestats\\_entry](#) [ic\\_stats](#)
- struct [cachestats\\_entry](#) [dc\\_stats](#)
- struct [immustats\\_entry](#) [immu\\_stats](#)
- struct [dmmustats\\_entry](#) [dmmu\\_stats](#)
- struct [raw\\_stats](#) [raw\\_stats](#)

## 6.19.1 Define Documentation

**6.19.1.1** `#define RAW_RANGE 1000`

## 6.19.2 Function Documentation

**6.19.2.1** `void adddstats (int item1, int item2, int cnt_dynamic, int depend)`

**6.19.2.2** `void addfstats (enum insn_type item1, enum insn_type item2, int cnt_dynamic, int depend)`

**6.19.2.3** `void addsstats (int item, int cnt_dynamic)`

**6.19.2.4** `void initstats ()`

**6.19.2.5** `void printstats ()`

## 6.19.3 Variable Documentation

**6.19.3.1** `struct cachestats_entry dc_stats`

data cache stats

**6.19.3.2** `struct dmmustats_entry dmmu_stats`

data MMU stats

**6.19.3.3** `struct cachestats_entry ic_stats`

instruction cache stats

**6.19.3.4** `struct immustats_entry immu_stats`

insn MMU stats

**6.19.3.5** `struct mstats_entry or1k_mstats`

misc units stats

**6.19.3.6** `struct raw_stats raw_stats`

RAW hazard stats

## 6.20 cpu/common/trace.c File Reference

```
#include "config.h"  
#include "trace.h"  
#include "sim-config.h"  
#include "abstract.h"  
#include "labels.h"
```

Include dependency graph for trace.c:

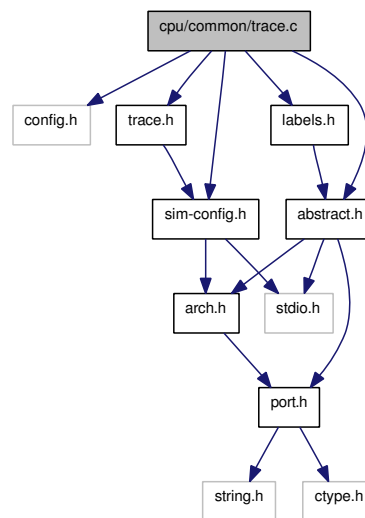

### Functions

- void `set_insnbrkpoint` (`oraddr_t addr`)

#### 6.20.1 Function Documentation

##### 6.20.1.1 void `set_insnbrkpoint` (`oraddr_t addr`)

Set instruction execution breakpoint

##### Parameters:

← *addr* The address for the breakpoint

Here is the call graph for this function:

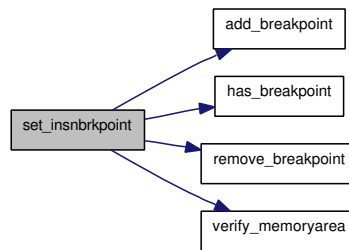

## 6.21 cpu/common/trace.h File Reference

```
#include "sim-config.h"
```

Include dependency graph for trace.h:

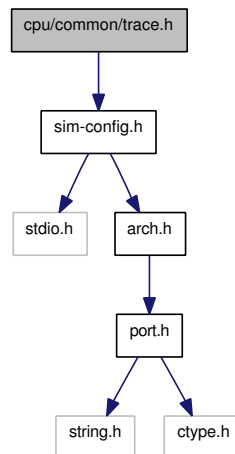

This graph shows which files directly or indirectly include this file:

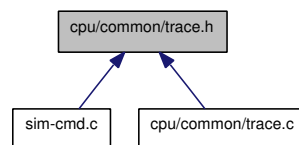

### Functions

- void [set\\_insnbrkpoint](#) (`oraddr_t` *addr*)

#### 6.21.1 Function Documentation

##### 6.21.1.1 void set\_insnbrkpoint (oraddr\_t *addr*)

Set instruction execution breakpoint

##### Parameters:

← *addr* The address for the breakpoint



Here is the call graph for this function:

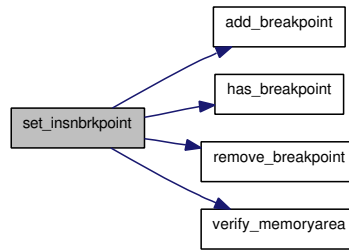

## 6.22 cpu/or1k/arch.h File Reference

```
#include "port.h"
```

Include dependency graph for arch.h:

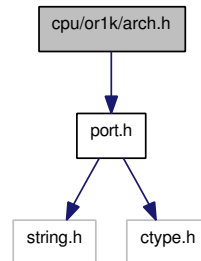

This graph shows which files directly or indirectly include this file:

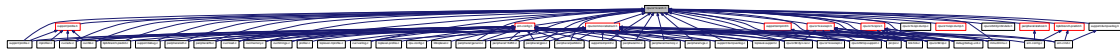

### Defines

- #define [LINK\\_REGNO](#) 9
- #define [ADDR\\_C\(c\)](#) `UINT32_C(c)`
- #define [REG\\_C\(c\)](#) `UINT32_C(c)`
- #define [PRIxADDR](#) "08" `PRIx32`
- #define [PRIxREG](#) "08" `PRIx32`
- #define [PRIdREG](#) `PRId32`

### Typedefs

- typedef `uint32_t` [oraddr\\_t](#)
- typedef `uint32_t` [uorreg\\_t](#)
- typedef `int32_t` [orreg\\_t](#)

#### 6.22.1 Define Documentation

##### 6.22.1.1 #define ADDR\_C(c) UINT32\_C(c)

##### 6.22.1.2 #define LINK\_REGNO 9

Index of the link register

##### 6.22.1.3 #define PRIdREG PRId32

print an openrisc register in decimals

**6.22.1.4 #define PRIxADDR "08" PRIx32**

print an openrisc address in hex

**6.22.1.5 #define PRIxREG "08" PRIx32**

print an openrisc register in hex

**6.22.1.6 #define REG\_C(c) UINT32\_C(c)****6.22.2 Typedef Documentation****6.22.2.1 typedef uint32\_t oraddr\_t**

Address as addressed by openrisc

**6.22.2.2 typedef int32\_t orreg\_t**

A signed register of openrisc

**6.22.2.3 typedef uint32\_t uorreg\_t**

An unsigned register of openrisc

## 6.23 cpu/or1k/except.c File Reference

```
#include "config.h"
#include "except.h"
#include "sim-config.h"
#include "arch.h"
#include "debug.h"
#include "spr-defs.h"
#include "execute.h"
#include "debug-unit.h"
```

Include dependency graph for except.c:

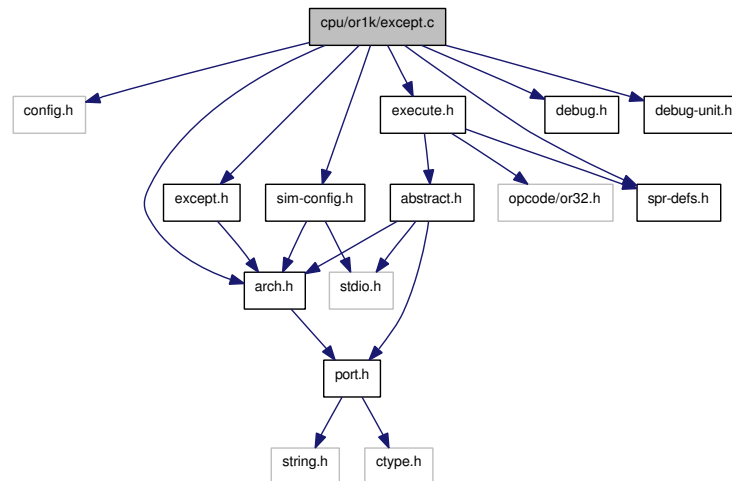

### Functions

- void `op_join_mem_cycles` (void)
- void `except_handle` (`oraddr_t` except, `oraddr_t` ea)

### Variables

- int `except_pending` = 0

## 6.23.1 Function Documentation

### 6.23.1.1 void except\_handle (oraddr\_t except, oraddr\_t ea)

Here is the call graph for this function:

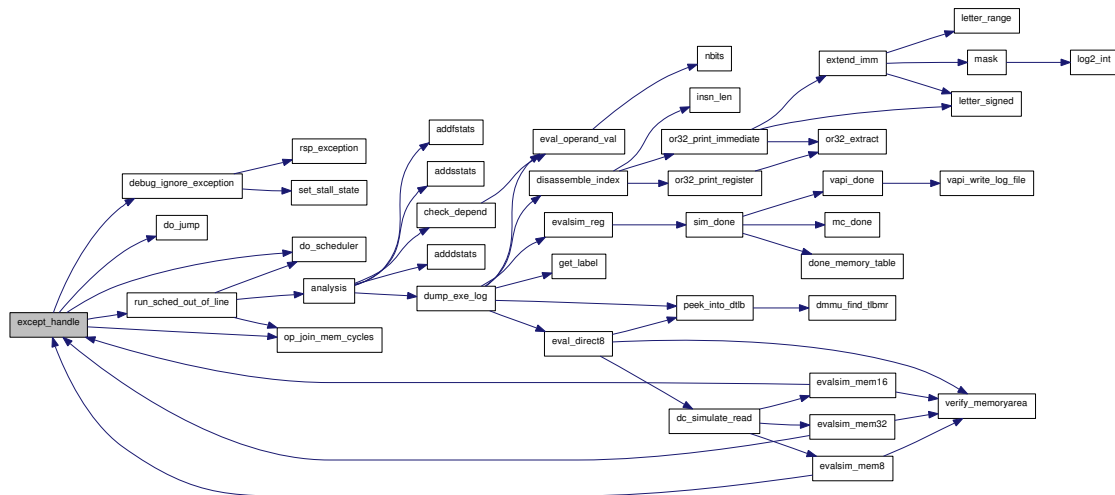

### 6.23.1.2 void op\_join\_mem\_cycles (void)

## 6.23.2 Variable Documentation

### 6.23.2.1 int except\_pending = 0

## 6.24 cpu/or1k/except.h File Reference

```
#include "arch.h"
```

Include dependency graph for except.h:

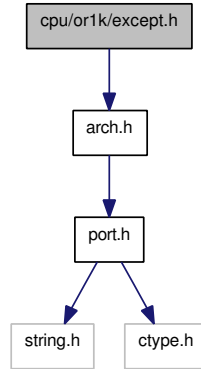

This graph shows which files directly or indirectly include this file:

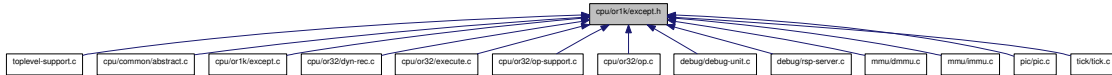

### Defines

- #define [EXCEPT\\_NONE](#) 0x0000
- #define [EXCEPT\\_RESET](#) 0x0100
- #define [EXCEPT\\_BUSERR](#) 0x0200
- #define [EXCEPT\\_DPF](#) 0x0300
- #define [EXCEPT\\_IPF](#) 0x0400
- #define [EXCEPT\\_TICK](#) 0x0500
- #define [EXCEPT\\_ALIGN](#) 0x0600
- #define [EXCEPT\\_ILLEGAL](#) 0x0700
- #define [EXCEPT\\_INT](#) 0x0800
- #define [EXCEPT\\_DTLBMISS](#) 0x0900
- #define [EXCEPT\\_ITLBMIS](#) 0x0a00
- #define [EXCEPT\\_RANGE](#) 0x0b00
- #define [EXCEPT\\_SYSCALL](#) 0x0c00
- #define [EXCEPT\\_FPE](#) 0x0d00
- #define [EXCEPT\\_TRAP](#) 0x0e00

### Functions

- void [except\\_handle](#) ([oraddr\\_t](#) except, [oraddr\\_t](#) ea)

### Variables

- int [except\\_pending](#)



## 6.24.1 Define Documentation

6.24.1.1 #define EXCEPT\_ALIGN 0x0600

6.24.1.2 #define EXCEPT\_BUSERR 0x0200

6.24.1.3 #define EXCEPT\_DPF 0x0300

6.24.1.4 #define EXCEPT\_DTLBMISS 0x0900

6.24.1.5 #define EXCEPT\_FPE 0x0d00

6.24.1.6 #define EXCEPT\_ILLEGAL 0x0700

6.24.1.7 #define EXCEPT\_INT 0x0800

6.24.1.8 #define EXCEPT\_IPF 0x0400

6.24.1.9 #define EXCEPT\_ITLBMIS 0x0a00

6.24.1.10 #define EXCEPT\_NONE 0x0000

6.24.1.11 #define EXCEPT\_RANGE 0x0b00

6.24.1.12 #define EXCEPT\_RESET 0x0100

6.24.1.13 #define EXCEPT\_SYSCALL 0x0c00

6.24.1.14 #define EXCEPT\_TICK 0x0500

6.24.1.15 #define EXCEPT\_TRAP 0x0e00

## 6.24.2 Function Documentation

6.24.2.1 void except\_handle (oraddr\_t except, oraddr\_t ea)

Here is the call graph for this function:

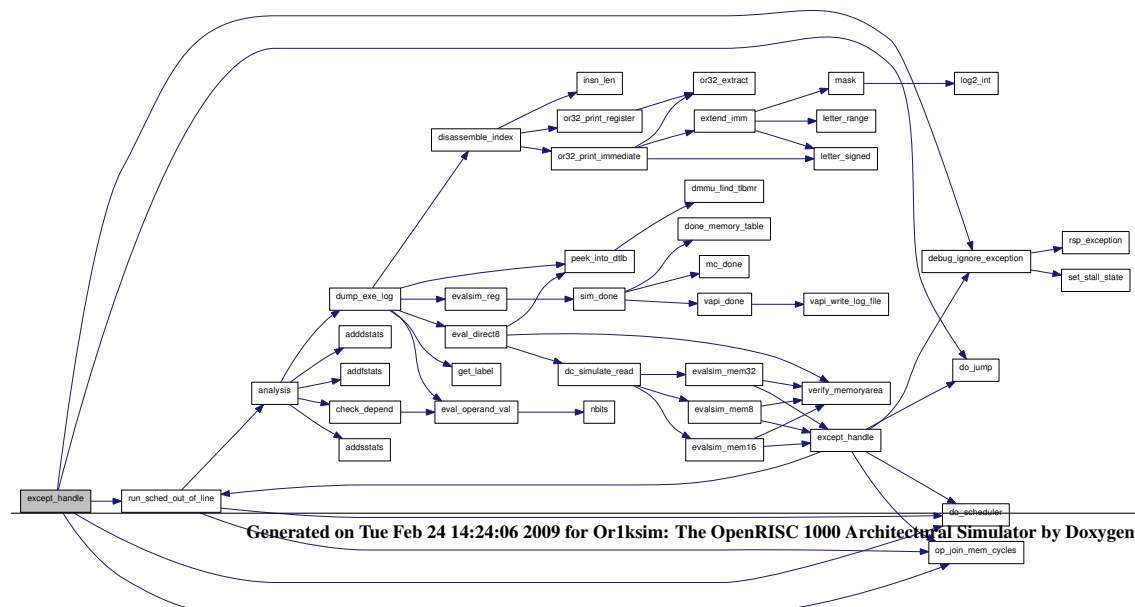



### 6.24.3 Variable Documentation

#### 6.24.3.1 int except\_pending

## 6.25 cpu/or1k/spr-defs.h File Reference

This graph shows which files directly or indirectly include this file:

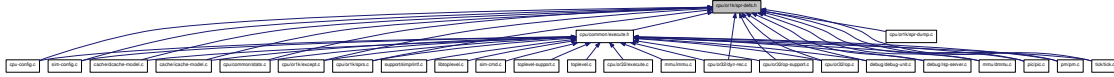

### Defines

- #define [MAX\\_GRP](#)s (32)
- #define [MAX\\_SPRS\\_PER\\_GRP\\_BITS](#) (11)
- #define [MAX\\_SPRS\\_PER\\_GRP](#) (1 << MAX\_SPRS\_PER\_GRP\_BITS)
- #define [MAX\\_SPRS](#) (0x10000)
- #define [SPRGROUP\\_SYS](#) (0 << MAX\_SPRS\_PER\_GRP\_BITS)
- #define [SPRGROUP\\_DMMU](#) (1 << MAX\_SPRS\_PER\_GRP\_BITS)
- #define [SPRGROUP\\_IMMU](#) (2 << MAX\_SPRS\_PER\_GRP\_BITS)
- #define [SPRGROUP\\_DC](#) (3 << MAX\_SPRS\_PER\_GRP\_BITS)
- #define [SPRGROUP\\_IC](#) (4 << MAX\_SPRS\_PER\_GRP\_BITS)
- #define [SPRGROUP\\_MAC](#) (5 << MAX\_SPRS\_PER\_GRP\_BITS)
- #define [SPRGROUP\\_D](#) (6 << MAX\_SPRS\_PER\_GRP\_BITS)
- #define [SPRGROUP\\_PC](#) (7 << MAX\_SPRS\_PER\_GRP\_BITS)
- #define [SPRGROUP\\_PM](#) (8 << MAX\_SPRS\_PER\_GRP\_BITS)
- #define [SPRGROUP\\_PIC](#) (9 << MAX\_SPRS\_PER\_GRP\_BITS)
- #define [SPRGROUP\\_TT](#) (10 << MAX\_SPRS\_PER\_GRP\_BITS)
- #define [SPR\\_VR](#) (SPRGROUP\_SYS + 0)
- #define [SPR\\_UPR](#) (SPRGROUP\_SYS + 1)
- #define [SPR\\_CPUCFGR](#) (SPRGROUP\_SYS + 2)
- #define [SPR\\_DMMUCFGR](#) (SPRGROUP\_SYS + 3)
- #define [SPR\\_IMMUCFGR](#) (SPRGROUP\_SYS + 4)
- #define [SPR\\_DCCFGR](#) (SPRGROUP\_SYS + 5)
- #define [SPR\\_ICCFGR](#) (SPRGROUP\_SYS + 6)
- #define [SPR\\_DCFGR](#) (SPRGROUP\_SYS + 7)
- #define [SPR\\_PCCFGR](#) (SPRGROUP\_SYS + 8)
- #define [SPR\\_NPC](#) (SPRGROUP\_SYS + 16)
- #define [SPR\\_SR](#) (SPRGROUP\_SYS + 17)
- #define [SPR\\_PPC](#) (SPRGROUP\_SYS + 18)
- #define [SPR\\_EPCR\\_BASE](#) (SPRGROUP\_SYS + 32)
- #define [SPR\\_EPCR\\_LAST](#) (SPRGROUP\_SYS + 47)
- #define [SPR\\_EEAR\\_BASE](#) (SPRGROUP\_SYS + 48)
- #define [SPR\\_EEAR\\_LAST](#) (SPRGROUP\_SYS + 63)
- #define [SPR\\_ESR\\_BASE](#) (SPRGROUP\_SYS + 64)
- #define [SPR\\_ESR\\_LAST](#) (SPRGROUP\_SYS + 79)
- #define [SPR\\_DMMUCR](#) (SPRGROUP\_DMMU + 0)
- #define [SPR\\_DTLBMR\\_BASE](#)(WAY) (SPRGROUP\_DMMU + 0x200 + (WAY) \* 0x100)
- #define [SPR\\_DTLBMR\\_LAST](#)(WAY) (SPRGROUP\_DMMU + 0x27f + (WAY) \* 0x100)
- #define [SPR\\_DTLBTR\\_BASE](#)(WAY) (SPRGROUP\_DMMU + 0x280 + (WAY) \* 0x100)
- #define [SPR\\_DTLBTR\\_LAST](#)(WAY) (SPRGROUP\_DMMU + 0x2ff + (WAY) \* 0x100)
- #define [SPR\\_IMMUCR](#) (SPRGROUP\_IMMU + 0)

- #define `SPR_ITLBMR_BASE(WAY)` (SPRGROUP\_IMMU + 0x200 + (WAY) \* 0x100)
- #define `SPR_ITLBMR_LAST(WAY)` (SPRGROUP\_IMMU + 0x27f + (WAY) \* 0x100)
- #define `SPR_ITLBTR_BASE(WAY)` (SPRGROUP\_IMMU + 0x280 + (WAY) \* 0x100)
- #define `SPR_ITLBTR_LAST(WAY)` (SPRGROUP\_IMMU + 0x2ff + (WAY) \* 0x100)
- #define `SPR_DCCR` (SPRGROUP\_DC + 0)
- #define `SPR_DCBPR` (SPRGROUP\_DC + 1)
- #define `SPR_DCBFR` (SPRGROUP\_DC + 2)
- #define `SPR_DCBIR` (SPRGROUP\_DC + 3)
- #define `SPR_DCBWR` (SPRGROUP\_DC + 4)
- #define `SPR_DCBLR` (SPRGROUP\_DC + 5)
- #define `SPR_DCR_BASE(WAY)` (SPRGROUP\_DC + 0x200 + (WAY) \* 0x200)
- #define `SPR_DCR_LAST(WAY)` (SPRGROUP\_DC + 0x3ff + (WAY) \* 0x200)
- #define `SPR_ICCR` (SPRGROUP\_IC + 0)
- #define `SPR_ICBPR` (SPRGROUP\_IC + 1)
- #define `SPR_ICBIR` (SPRGROUP\_IC + 2)
- #define `SPR_ICBLR` (SPRGROUP\_IC + 3)
- #define `SPR_ICR_BASE(WAY)` (SPRGROUP\_IC + 0x200 + (WAY) \* 0x200)
- #define `SPR_ICR_LAST(WAY)` (SPRGROUP\_IC + 0x3ff + (WAY) \* 0x200)
- #define `SPR_MACLO` (SPRGROUP\_MAC + 1)
- #define `SPR_MACHI` (SPRGROUP\_MAC + 2)
- #define `SPR_DVR(N)` (SPRGROUP\_D + (N))
- #define `SPR_DCR(N)` (SPRGROUP\_D + 8 + (N))
- #define `SPR_DMR1` (SPRGROUP\_D + 16)
- #define `SPR_DMR2` (SPRGROUP\_D + 17)
- #define `SPR_DWCR0` (SPRGROUP\_D + 18)
- #define `SPR_DWCR1` (SPRGROUP\_D + 19)
- #define `SPR_DSR` (SPRGROUP\_D + 20)
- #define `SPR_DRR` (SPRGROUP\_D + 21)
- #define `SPR_PCCR(N)` (SPRGROUP\_PC + (N))
- #define `SPR_PCMR(N)` (SPRGROUP\_PC + 8 + (N))
- #define `SPR_PMR` (SPRGROUP\_PM + 0)
- #define `SPR_PICMR` (SPRGROUP\_PIC + 0)
- #define `SPR_PICPR` (SPRGROUP\_PIC + 1)
- #define `SPR_PICSR` (SPRGROUP\_PIC + 2)
- #define `SPR_TTMR` (SPRGROUP\_TT + 0)
- #define `SPR_TTCR` (SPRGROUP\_TT + 1)
- #define `SPR_VR_VER` 0xff000000
- #define `SPR_VR_CFG` 0x00ff0000
- #define `SPR_VR_RES` 0x00ff0000
- #define `SPR_VR_REV` 0x0000003f
- #define `SPR_VR_VER_OFF` 24
- #define `SPR_VR_CFG_OFF` 16
- #define `SPR_VR_REV_OFF` 0
- #define `SPR_UPR_UP` 0x00000001
- #define `SPR_UPR_DCP` 0x00000002
- #define `SPR_UPR_ICP` 0x00000004
- #define `SPR_UPR_DMP` 0x00000008
- #define `SPR_UPR_IMP` 0x00000010
- #define `SPR_UPR_MP` 0x00000020
- #define `SPR_UPR_DUP` 0x00000040

- #define `SPR_UPR_PCUP` 0x00000080
- #define `SPR_UPR_PMP` 0x00000100
- #define `SPR_UPR_PICP` 0x00000200
- #define `SPR_UPR_TTP` 0x00000400
- #define `SPR_UPR_RES` 0x00fe0000
- #define `SPR_UPR_CUP` 0xff000000
- #define `SPR_CPUCFGR_NSGF` 0x0000000f
- #define `SPR_CPUCFGR_CGF` 0x00000010
- #define `SPR_CPUCFGR_OB32S` 0x00000020
- #define `SPR_CPUCFGR_OB64S` 0x00000040
- #define `SPR_CPUCFGR_OF32S` 0x00000080
- #define `SPR_CPUCFGR_OF64S` 0x00000100
- #define `SPR_CPUCFGR_OV64S` 0x00000200
- #define `SPR_CPUCFGR_RES` 0xffffc00
- #define `SPR_DCFGR_NDP` 0x00000007
- #define `SPR_DCFGR_NDP1` 0x00000000
- #define `SPR_DCFGR_NDP2` 0x00000001
- #define `SPR_DCFGR_NDP3` 0x00000002
- #define `SPR_DCFGR_NDP4` 0x00000003
- #define `SPR_DCFGR_NDP5` 0x00000004
- #define `SPR_DCFGR_NDP6` 0x00000005
- #define `SPR_DCFGR_NDP7` 0x00000006
- #define `SPR_DCFGR_NDP8` 0x00000007
- #define `SPR_DCFGR_WPCI` 0x00000008
- #define `MATCHPOINTS_TO_NDP`(n)
- #define `MAX_MATCHPOINTS` 8
- #define `MAX_WATCHPOINTS` (MAX\_MATCHPOINTS + 2)
- #define `SPR_SR_SM` 0x00000001
- #define `SPR_SR_TEE` 0x00000002
- #define `SPR_SR_IEE` 0x00000004
- #define `SPR_SR_DCE` 0x00000008
- #define `SPR_SR_ICE` 0x00000010
- #define `SPR_SR_DME` 0x00000020
- #define `SPR_SR_IME` 0x00000040
- #define `SPR_SR_LEE` 0x00000080
- #define `SPR_SR_CE` 0x00000100
- #define `SPR_SR_F` 0x00000200
- #define `SPR_SR_CY` 0x00000400
- #define `SPR_SR_OV` 0x00000800
- #define `SPR_SR_OVE` 0x00001000
- #define `SPR_SR_DSX` 0x00002000
- #define `SPR_SR_EPH` 0x00004000
- #define `SPR_SR_FO` 0x00008000
- #define `SPR_SR_SUMRA` 0x00010000
- #define `SPR_SR_RES` 0x0ffe0000
- #define `SPR_SR_CID` 0xf0000000
- #define `SPR_DMMUCR_P2S` 0x0000003e
- #define `SPR_DMMUCR_P1S` 0x000007c0
- #define `SPR_DMMUCR_VADDR_WIDTH` 0x0000f800
- #define `SPR_DMMUCR_PADDR_WIDTH` 0x000f0000

- #define `SPR_IMMUCR_P2S` 0x0000003e
- #define `SPR_IMMUCR_P1S` 0x000007c0
- #define `SPR_IMMUCR_VADDR_WIDTH` 0x0000f800
- #define `SPR_IMMUCR_PADDR_WIDTH` 0x000f0000
- #define `SPR_DTLBMR_V` 0x00000001
- #define `SPR_DTLBMR_PL1` 0x00000002
- #define `SPR_DTLBMR_CID` 0x0000003c
- #define `SPR_DTLBMR_LRU` 0x000000c0
- #define `SPR_DTLBMR_VPN` 0xffff000
- #define `SPR_DTLBTR_CC` 0x00000001
- #define `SPR_DTLBTR_CI` 0x00000002
- #define `SPR_DTLBTR_WBC` 0x00000004
- #define `SPR_DTLBTR_WOM` 0x00000008
- #define `SPR_DTLBTR_A` 0x00000010
- #define `SPR_DTLBTR_D` 0x00000020
- #define `SPR_DTLBTR_URE` 0x00000040
- #define `SPR_DTLBTR_UWE` 0x00000080
- #define `SPR_DTLBTR_SRE` 0x00000100
- #define `SPR_DTLBTR_SWE` 0x00000200
- #define `SPR_DTLBTR_PPN` 0xffff000
- #define `SPR_ITLBMR_V` 0x00000001
- #define `SPR_ITLBMR_PL1` 0x00000002
- #define `SPR_ITLBMR_CID` 0x0000003c
- #define `SPR_ITLBMR_LRU` 0x000000c0
- #define `SPR_ITLBMR_VPN` 0xffff000
- #define `SPR_ITLBTR_CC` 0x00000001
- #define `SPR_ITLBTR_CI` 0x00000002
- #define `SPR_ITLBTR_WBC` 0x00000004
- #define `SPR_ITLBTR_WOM` 0x00000008
- #define `SPR_ITLBTR_A` 0x00000010
- #define `SPR_ITLBTR_D` 0x00000020
- #define `SPR_ITLBTR_SXE` 0x00000040
- #define `SPR_ITLBTR_UXE` 0x00000080
- #define `SPR_ITLBTR_PPN` 0xffff000
- #define `SPR_DCCR_EW` 0x000000ff
- #define `SPR_ICCR_EW` 0x000000ff
- #define `SPR_DCCFGR_NCW` 0x00000007
- #define `SPR_DCCFGR_NCS` 0x00000078
- #define `SPR_DCCFGR_CBS` 0x00000080
- #define `SPR_DCCFGR_CWS` 0x00000100
- #define `SPR_DCCFGR_CCRI` 0x00000200
- #define `SPR_DCCFGR_CBIRI` 0x00000400
- #define `SPR_DCCFGR_CBPRI` 0x00000800
- #define `SPR_DCCFGR_CBLRI` 0x00001000
- #define `SPR_DCCFGR_CBFRI` 0x00002000
- #define `SPR_DCCFGR_CBWBRI` 0x00004000
- #define `SPR_DCCFGR_NCW_OFF` 0
- #define `SPR_DCCFGR_NCS_OFF` 3
- #define `SPR_DCCFGR_CBS_OFF` 7
- #define `SPR_ICCFGR_NCW` 0x00000007

- #define `SPR_ICCFGR_NCS` 0x00000078
- #define `SPR_ICCFGR_CBS` 0x00000080
- #define `SPR_ICCFGR_CCRI` 0x00000200
- #define `SPR_ICCFGR_CBIRI` 0x00000400
- #define `SPR_ICCFGR_CBPRI` 0x00000800
- #define `SPR_ICCFGR_CBLRI` 0x00001000
- #define `SPR_ICCFGR_NCW_OFF` 0
- #define `SPR_ICCFGR_NCS_OFF` 3
- #define `SPR_ICCFGR_CBS_OFF` 7
- #define `SPR_DMMUCFGR_NTW` 0x00000003
- #define `SPR_DMMUCFGR_NTS` 0x0000001C
- #define `SPR_DMMUCFGR_NAE` 0x000000E0
- #define `SPR_DMMUCFGR_CRI` 0x00000100
- #define `SPR_DMMUCFGR_PRI` 0x00000200
- #define `SPR_DMMUCFGR_TEIRI` 0x00000400
- #define `SPR_DMMUCFGR_HTR` 0x00000800
- #define `SPR_DMMUCFGR_NTW_OFF` 0
- #define `SPR_DMMUCFGR_NTS_OFF` 2
- #define `SPR_IMMUCFGR_NTW` 0x00000003
- #define `SPR_IMMUCFGR_NTS` 0x0000001C
- #define `SPR_IMMUCFGR_NAE` 0x000000E0
- #define `SPR_IMMUCFGR_CRI` 0x00000100
- #define `SPR_IMMUCFGR_PRI` 0x00000200
- #define `SPR_IMMUCFGR_TEIRI` 0x00000400
- #define `SPR_IMMUCFGR_HTR` 0x00000800
- #define `SPR_IMMUCFGR_NTW_OFF` 0
- #define `SPR_IMMUCFGR_NTS_OFF` 2
- #define `SPR_DCR_DP` 0x00000001
- #define `SPR_DCR_CC` 0x0000000e
- #define `SPR_DCR_SC` 0x00000010
- #define `SPR_DCR_CT` 0x000000e0
- #define `SPR_DCR_CC_MASKED` 0x00000000
- #define `SPR_DCR_CC_EQUAL` 0x00000002
- #define `SPR_DCR_CC_LESS` 0x00000004
- #define `SPR_DCR_CC_LESSE` 0x00000006
- #define `SPR_DCR_CC_GREAT` 0x00000008
- #define `SPR_DCR_CC_GREATE` 0x0000000a
- #define `SPR_DCR_CC_NEQUAL` 0x0000000c
- #define `SPR_DCR_CT_DISABLED` 0x00000000
- #define `SPR_DCR_CT_IFEA` 0x00000020
- #define `SPR_DCR_CT_LEA` 0x00000040
- #define `SPR_DCR_CT_SEA` 0x00000060
- #define `SPR_DCR_CT_LD` 0x00000080
- #define `SPR_DCR_CT_SD` 0x000000a0
- #define `SPR_DCR_CT_LSEA` 0x000000c0
- #define `SPR_DCR_CT_LSD` 0x000000e0
- #define `SPR_DMR1_CW` 0x000fffff
- #define `SPR_DMR1_CW0_AND` 0x00000001
- #define `SPR_DMR1_CW0_OR` 0x00000002
- #define `SPR_DMR1_CW0` (`SPR_DMR1_CW0_AND` | `SPR_DMR1_CW0_OR`)

- #define `SPR_DMR1_CW1_AND` 0x00000004
- #define `SPR_DMR1_CW1_OR` 0x00000008
- #define `SPR_DMR1_CW1` (SPR\_DMR1\_CW1\_AND | SPR\_DMR1\_CW1\_OR)
- #define `SPR_DMR1_CW2_AND` 0x00000010
- #define `SPR_DMR1_CW2_OR` 0x00000020
- #define `SPR_DMR1_CW2` (SPR\_DMR1\_CW2\_AND | SPR\_DMR1\_CW2\_OR)
- #define `SPR_DMR1_CW3_AND` 0x00000040
- #define `SPR_DMR1_CW3_OR` 0x00000080
- #define `SPR_DMR1_CW3` (SPR\_DMR1\_CW3\_AND | SPR\_DMR1\_CW3\_OR)
- #define `SPR_DMR1_CW4_AND` 0x00000100
- #define `SPR_DMR1_CW4_OR` 0x00000200
- #define `SPR_DMR1_CW4` (SPR\_DMR1\_CW4\_AND | SPR\_DMR1\_CW4\_OR)
- #define `SPR_DMR1_CW5_AND` 0x00000400
- #define `SPR_DMR1_CW5_OR` 0x00000800
- #define `SPR_DMR1_CW5` (SPR\_DMR1\_CW5\_AND | SPR\_DMR1\_CW5\_OR)
- #define `SPR_DMR1_CW6_AND` 0x00001000
- #define `SPR_DMR1_CW6_OR` 0x00002000
- #define `SPR_DMR1_CW6` (SPR\_DMR1\_CW6\_AND | SPR\_DMR1\_CW6\_OR)
- #define `SPR_DMR1_CW7_AND` 0x00004000
- #define `SPR_DMR1_CW7_OR` 0x00008000
- #define `SPR_DMR1_CW7` (SPR\_DMR1\_CW7\_AND | SPR\_DMR1\_CW7\_OR)
- #define `SPR_DMR1_CW8_AND` 0x00010000
- #define `SPR_DMR1_CW8_OR` 0x00020000
- #define `SPR_DMR1_CW8` (SPR\_DMR1\_CW8\_AND | SPR\_DMR1\_CW8\_OR)
- #define `SPR_DMR1_CW9_AND` 0x00040000
- #define `SPR_DMR1_CW9_OR` 0x00080000
- #define `SPR_DMR1_CW9` (SPR\_DMR1\_CW9\_AND | SPR\_DMR1\_CW9\_OR)
- #define `SPR_DMR1_RES1` 0x00300000
- #define `SPR_DMR1_ST` 0x00400000
- #define `SPR_DMR1_BT` 0x00800000
- #define `SPR_DMR1_RES2` 0xff000000
- #define `SPR_DMR2_WCE0` 0x00000001
- #define `SPR_DMR2_WCE1` 0x00000002
- #define `SPR_DMR2_AWTC` 0x0000ffc
- #define `SPR_DMR2_AWTC_OFF` 2
- #define `SPR_DMR2_WGB` 0x003ff000
- #define `SPR_DMR2_WGB_OFF` 12
- #define `SPR_DMR2_WBS` 0xffc00000
- #define `SPR_DMR2_WBS_OFF` 22
- #define `SPR_DWCR_COUNT` 0x0000ffff
- #define `SPR_DWCR_MATCH` 0xffff0000
- #define `SPR_DWCR_MATCH_OFF` 16
- #define `SPR_DSR_RSTE` 0x00000001
- #define `SPR_DSR_BUSEE` 0x00000002
- #define `SPR_DSR_DPFE` 0x00000004
- #define `SPR_DSR_IPFE` 0x00000008
- #define `SPR_DSR_TTE` 0x00000010
- #define `SPR_DSR_AE` 0x00000020
- #define `SPR_DSR_IIE` 0x00000040
- #define `SPR_DSR_IE` 0x00000080

- #define `SPR_DSR_DME` 0x00000100
- #define `SPR_DSR_IME` 0x00000200
- #define `SPR_DSR_RE` 0x00000400
- #define `SPR_DSR_SCE` 0x00000800
- #define `SPR_DSR_FPE` 0x00001000
- #define `SPR_DSR_TE` 0x00002000
- #define `SPR_DRR_RSTE` 0x00000001
- #define `SPR_DRR_BUSEE` 0x00000002
- #define `SPR_DRR_DPFE` 0x00000004
- #define `SPR_DRR_IPFE` 0x00000008
- #define `SPR_DRR_TTE` 0x00000010
- #define `SPR_DRR_AE` 0x00000020
- #define `SPR_DRR_IIE` 0x00000040
- #define `SPR_DRR_IE` 0x00000080
- #define `SPR_DRR_DME` 0x00000100
- #define `SPR_DRR_IME` 0x00000200
- #define `SPR_DRR_RE` 0x00000400
- #define `SPR_DRR_SCE` 0x00000800
- #define `SPR_DRR_FPE` 0x00001000
- #define `SPR_DRR_TE` 0x00002000
- #define `SPR_PCMR_CP` 0x00000001
- #define `SPR_PCMR_UMRA` 0x00000002
- #define `SPR_PCMR_CISM` 0x00000004
- #define `SPR_PCMR_CIUM` 0x00000008
- #define `SPR_PCMR_LA` 0x00000010
- #define `SPR_PCMR_SA` 0x00000020
- #define `SPR_PCMR_IF` 0x00000040
- #define `SPR_PCMR_DCM` 0x00000080
- #define `SPR_PCMR_ICM` 0x00000100
- #define `SPR_PCMR_IFS` 0x00000200
- #define `SPR_PCMR_LSUS` 0x00000400
- #define `SPR_PCMR_BS` 0x00000800
- #define `SPR_PCMR_DTLBM` 0x00001000
- #define `SPR_PCMR_ITLBM` 0x00002000
- #define `SPR_PCMR_DDS` 0x00004000
- #define `SPR_PCMR_WPE` 0x03ff8000
- #define `SPR_PMR_SDF` 0x0000000f
- #define `SPR_PMR_DME` 0x00000010
- #define `SPR_PMR_SME` 0x00000020
- #define `SPR_PMR_DCGE` 0x00000040
- #define `SPR_PMR_SUME` 0x00000080
- #define `SPR_PICMR_IUM` 0xffffffc
- #define `SPR_PICPR_IPRIO` 0xffffffc
- #define `SPR_PICSR_IS` 0xfffffff
- #define `SPR_TTCR_PERIOD` 0x0fffff
- #define `SPR_TTMR_PERIOD` `SPR_TTCR_PERIOD`
- #define `SPR_TTMR_IP` 0x10000000
- #define `SPR_TTMR_IE` 0x20000000
- #define `SPR_TTMR_RT` 0x40000000
- #define `SPR_TTMR_SR` 0x80000000



- #define `SPR_TTMR_CR` 0xc0000000
- #define `SPR_TTMR_M` 0xc0000000
- #define `NOP_NOP` 0x0000
- #define `NOP_EXIT` 0x0001
- #define `NOP_REPORT` 0x0002
- #define `NOP_PRINTF` 0x0003
- #define `NOP_PUTC` 0x0004
- #define `NOP_CNT_RESET` 0x0005
- #define `NOP_REPORT_FIRST` 0x0400
- #define `NOP_REPORT_LAST` 0x03ff

## 6.25.1 Define Documentation

### 6.25.1.1 #define MATCHPOINTS\_TO\_NDP(n)

**Value:**

```
(1 == n ? SPR_DCFGR_NDP1 : \  
2 == n ? SPR_DCFGR_NDP2 : \  
3 == n ? SPR_DCFGR_NDP3 : \  
4 == n ? SPR_DCFGR_NDP4 : \  
5 == n ? SPR_DCFGR_NDP5 : \  
6 == n ? SPR_DCFGR_NDP6 : \  
7 == n ? SPR_DCFGR_NDP7 : SPR_DCFGR_NDP8)
```



- 6.25.1.2 `#define MAX_GRPS (32)`
- 6.25.1.3 `#define MAX_MATCHPOINTS 8`
- 6.25.1.4 `#define MAX_SPRS (0x10000)`
- 6.25.1.5 `#define MAX_SPRS_PER_GRP (1 << MAX_SPRS_PER_GRP_BITS)`
- 6.25.1.6 `#define MAX_SPRS_PER_GRP_BITS (11)`
- 6.25.1.7 `#define MAX_WATCHPOINTS (MAX_MATCHPOINTS + 2)`
- 6.25.1.8 `#define NOP_CNT_RESET 0x0005`
- 6.25.1.9 `#define NOP_EXIT 0x0001`
- 6.25.1.10 `#define NOP_NOP 0x0000`
- 6.25.1.11 `#define NOP_PRINTF 0x0003`
- 6.25.1.12 `#define NOP_PUTC 0x0004`
- 6.25.1.13 `#define NOP_REPORT 0x0002`
- 6.25.1.14 `#define NOP_REPORT_FIRST 0x0400`
- 6.25.1.15 `#define NOP_REPORT_LAST 0x03ff`
- 6.25.1.16 `#define SPR_CPUCFGR (SPRGROUP_SYS + 2)`
- 6.25.1.17 `#define SPR_CPUCFGR_CGF 0x00000010`
- 6.25.1.18 `#define SPR_CPUCFGR_NSGF 0x0000000f`
- 6.25.1.19 `#define SPR_CPUCFGR_OB32S 0x00000020`
- 6.25.1.20 `#define SPR_CPUCFGR_OB64S 0x00000040`
- 6.25.1.21 `#define SPR_CPUCFGR_OF32S 0x00000080`
- 6.25.1.22 `#define SPR_CPUCFGR_OF64S 0x00000100`
- 6.25.1.23 `#define SPR_CPUCFGR_OV64S 0x00000200`
- 6.25.1.24 `#define SPR_CPUCFGR_RES 0xffffc00`
- 6.25.1.25 `#define SPR_DCBFR (SPRGROUP_DC + 2)`
- 6.25.1.26 `#define SPR_DCBIR (SPRGROUP_DC + 3)`
- 6.25.1.27 `#define SPR_DCBLR (SPRGROUP_DC + 5)`
- 6.25.1.28 `#define SPR_DCBPR (SPRGROUP_DC + 1)`
- 6.25.1.29 `#define SPR_DCBWR (SPRGROUP_DC + 4)`
- 6.25.1.30 `#define SPR_DCCFGR (SPRGROUP_SYS + 5)`
- 6.25.1.31 `#define SPR_DCCFGR_CBFRI 0x00002000`
- 6.25.1.32 `#define SPR_DCCFGR_CBIRI 0x00000400`

## 6.26 cpu/or1k/spr-dump.c File Reference

```
#include "config.h"
#include "port.h"
#include <stdio.h>
#include "arch.h"
#include "spr-defs.h"
#include "debug.h"
#include "misc.h"
```

Include dependency graph for spr-dump.c:

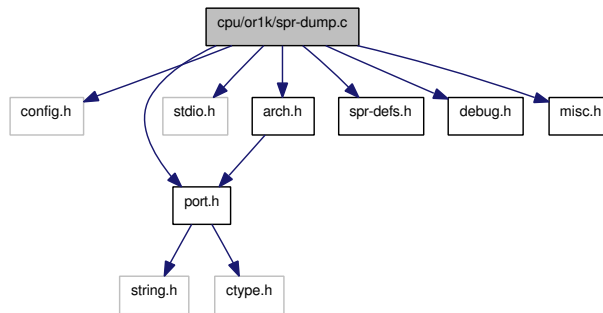

### Data Structures

- struct [spr\\_bit\\_def](#)
- struct [spr\\_def](#)

### Functions

- char \* [dump\\_spr](#) (uint16\_t spr, uorreg\_t spr\_val)

### Variables

- static struct [spr\\_bit\\_def](#) spr\_one\_val []
- static struct [spr\\_bit\\_def](#) spr\_sr []
- static struct [spr\\_bit\\_def](#) spr\_vr []
- static struct [spr\\_bit\\_def](#) spr\_upr []
- static struct [spr\\_bit\\_def](#) spr\_cpucfgr []
- static struct [spr\\_bit\\_def](#) spr\_dmmucfgr []
- static struct [spr\\_bit\\_def](#) spr\_immucfgr []
- static struct [spr\\_bit\\_def](#) spr\_dccfgr []
- static struct [spr\\_bit\\_def](#) spr\_iccfgr []
- static struct [spr\\_bit\\_def](#) spr\_dcfgr []
- static struct [spr\\_def](#) spr\_sys\_group []
- static struct [spr\\_bit\\_def](#) spr\_dmmucr []
- static struct [spr\\_bit\\_def](#) spr\_dtlbmr []

- static struct `spr_bit_def spr_dtlbtr []`
- static struct `spr_def spr_dmmu_group []`
- static struct `spr_bit_def spr_immucr []`
- static struct `spr_bit_def spr_itlbmr []`
- static struct `spr_bit_def spr_itlbtr []`
- static struct `spr_def spr_immu_group []`
- static struct `spr_bit_def spr_dccr []`
- static struct `spr_def spr_dc_group []`
- static struct `spr_bit_def spr_iccr []`
- static struct `spr_def spr_ic_group []`
- static struct `spr_def spr_mac_group []`
- static struct `spr_bit_def spr_dmr1 []`
- static struct `spr_bit_def spr_dmr2 []`
- static struct `spr_bit_def spr_dwcr []`
- static struct `spr_bit_def spr_dsr []`
- static struct `spr_bit_def spr_drr []`
- static struct `spr_def spr_d_group []`
- static struct `spr_bit_def spr_pcmr []`
- static struct `spr_def spr_pc_group []`
- static struct `spr_bit_def spr_pmr []`
- static struct `spr_def spr_pm_group []`
- static struct `spr_bit_def spr_picmr []`
- static struct `spr_def spr_pic_group []`
- static struct `spr_bit_def spr_tmr []`
- static struct `spr_def spr_tt_group []`
- static struct `spr_def * spr_groups []`
- static char `ret_spr [1000]`

## 6.26.1 Function Documentation

### 6.26.1.1 `char* dump_spr (uint16_t spr, uorreg_t spr_val)`

Here is the call graph for this function:



## 6.26.2 Variable Documentation

### 6.26.2.1 `char ret_spr[1000]` [static]

### 6.26.2.2 `struct spr_bit_def spr_cpucfgr[]` [static]

**Initial value:**

```

{
{ "CPUCFGR_OB32S", SPR_CPUCFGR_OB32S },
{ "CPUCFGR_OB64S", SPR_CPUCFGR_OB64S },
{ "CPUCFGR_OF32S", SPR_CPUCFGR_OF32S },
{ "CPUCFGR_OF64S", SPR_CPUCFGR_OF64S },
{ "CPUCFGR_OV64S", SPR_CPUCFGR_OV64S },
{ NULL, 0 } }
  
```

**6.26.2.3 struct spr\_def spr\_d\_group[] [static]****Initial value:**

```
{
    { 0x10, 0x10, "SPR_DMR1", spr_dmr1 },
    { 0x11, 0x11, "SPR_DMR2", spr_dmr2 },
    { 0x12, 0x12, "SPR_DWCR0", spr_dwcr },
    { 0x13, 0x13, "SPR_DWCR1", spr_dwcr },
    { 0x14, 0x14, "SPR_DSR", spr_dsr },
    { 0x15, 0x15, "SPR_DRR", spr_drr },
    { -1, -1, NULL, NULL } }
```

**6.26.2.4 struct spr\_def spr\_dc\_group[] [static]****Initial value:**

```
{
    { 0x000, 0x000, "SPR_DCCR", spr_dCCR },
    { 0x001, 0x001, "SPR_DCBPR", spr_one_val },
    { 0x002, 0x002, "SPR_DCBFR", spr_one_val },
    { 0x003, 0x003, "SPR_DCBIR", spr_one_val },
    { 0x004, 0x004, "SPR_DCBWR", spr_one_val },
    { 0x005, 0x005, "SPR_DCBLR", spr_one_val },
    { 0x200, 0x3ff, "SPR_DCR way 0 set %i", spr_one_val },
    { 0x400, 0x5ff, "SPR_DCR way 1 set %i", spr_one_val },
    { 0x600, 0x7ff, "SPR_DCR way 2 set %i", spr_one_val },
    { 0x800, 0x9ff, "SPR_DCR way 3 set %i", spr_one_val },
    { -1, -1, NULL, NULL } }
```

**6.26.2.5 struct spr\_bit\_def spr\_dccfgr[] [static]****Initial value:**

```
{
    { "DCCFGR_NCW", SPR_DCCFGR_NCW },
    { "DCCFGR_NCS", SPR_DCCFGR_NCS },
    { "DCCFGR_CBS", SPR_DCCFGR_CBS },
    { "DCCFGR_CWS", SPR_DCCFGR_CWS },
    { "DCCFGR_CCRI", SPR_DCCFGR_CCRI },
    { "DCCFGR_CBIRI", SPR_DCCFGR_CBIRI },
    { "DCCFGR_CBPRI", SPR_DCCFGR_CBPRI },
    { "DCCFGR_CBLRI", SPR_DCCFGR_CBLRI },
    { "DCCFGR_CBFRI", SPR_DCCFGR_CBFRI },
    { "DCCFGR_CBWBRI", SPR_DCCFGR_CBWBRI },
    { NULL, 0 } }
```

**6.26.2.6 struct spr\_bit\_def spr\_dCCR[] [static]****Initial value:**

```
{
    { "DCCR_EW", SPR_DCCR_EW },
    { NULL, 0 } }
```

**6.26.2.7 struct spr\_bit\_def spr\_dcfgr[] [static]****Initial value:**

```
{
{ "DCFGR_NDP", SPR_DCFGR_NDP },
{ "DCFGR_WPCI", SPR_DCFGR_WPCI },
{ NULL, 0 } }
```

**6.26.2.8 struct spr\_def spr\_dmmu\_group[] [static]****Initial value:**

```
{
{ 0, 0, "SPR_DMMUCR", spr_dmmucr },
{ 0x200, 0x27f, "SPR_DTLBMR way 0 set %i", spr_dtlbmr },
{ 0x280, 0x2ff, "SPR_DTLBTR way 0 set %i", spr_dtlbtr },
{ 0x300, 0x37f, "SPR_DTLBMR way 1 set %i", spr_dtlbmr },
{ 0x380, 0x3ff, "SPR_DTLBTR way 1 set %i", spr_dtlbtr },
{ 0x400, 0x47f, "SPR_DTLBMR way 2 set %i", spr_dtlbmr },
{ 0x480, 0x4ff, "SPR_DTLBTR way 2 set %i", spr_dtlbtr },
{ 0x500, 0x57f, "SPR_DTLBMR way 3 set %i", spr_dtlbmr },
{ 0x580, 0x5ff, "SPR_DTLBTR way 3 set %i", spr_dtlbtr },
{ -1, -1, NULL, NULL } }
```

**6.26.2.9 struct spr\_bit\_def spr\_dmmucfgr[] [static]****Initial value:**

```
{
{ "DMMUCFGR_NTW", SPR_DMMUCFGR_NTW },
{ "DMMUCFGR_NTS", SPR_DMMUCFGR_NTS },
{ "DMMUCFGR_NAE", SPR_DMMUCFGR_NAE },
{ "DMMUCFGR_CRI", SPR_DMMUCFGR_CRI },
{ "DMMUCFGR_PRI", SPR_DMMUCFGR_PRI },
{ "DMMUCFGR_TEIRI", SPR_DMMUCFGR_TEIRI },
{ "DMMUCFGR_HTR", SPR_DMMUCFGR_HTR },
{ NULL, 0 } }
```

**6.26.2.10 struct spr\_bit\_def spr\_dmmucr[] [static]****Initial value:**

```
{
{ "DMMUCR_P2S", SPR_DMMUCR_P2S },
{ "DMMUCR_P1S", SPR_DMMUCR_P1S },
{ "DMMUCR_VADDR_WIDTH", SPR_DMMUCR_VADDR_WIDTH },
{ "DMMUCR_PADDR_WIDTH", SPR_DMMUCR_PADDR_WIDTH },
{ NULL, 0 } }
```

**6.26.2.11 struct spr\_bit\_def spr\_dmr1[] [static]****Initial value:**

```

{
{ "DMR1_CW0",  SPR_DMR1_CW0  },
{ "DMR1_CW1",  SPR_DMR1_CW1  },
{ "DMR1_CW2",  SPR_DMR1_CW2  },
{ "DMR1_CW3",  SPR_DMR1_CW3  },
{ "DMR1_CW4",  SPR_DMR1_CW4  },
{ "DMR1_CW5",  SPR_DMR1_CW5  },
{ "DMR1_CW6",  SPR_DMR1_CW6  },
{ "DMR1_CW7",  SPR_DMR1_CW7  },
{ "DMR1_CW8",  SPR_DMR1_CW8  },
{ "DMR1_CW9",  SPR_DMR1_CW9  },
{ "DMR1_RES1", SPR_DMR1_RES1 },
{ "DMR1_ST",   SPR_DMR1_ST   },
{ "DMR1_BT",   SPR_DMR1_BT   },
{ "DMR1_RES2", SPR_DMR1_RES2 },
{ NULL,       0               } }

```

**6.26.2.12 struct spr\_bit\_def spr\_dmr2[] [static]****Initial value:**

```

{
{ "DMR2_WCE0", SPR_DMR2_WCE0 },
{ "DMR2_WCE1", SPR_DMR2_WCE1 },
{ "DMR2_AWTC", SPR_DMR2_AWTC },
{ "DMR2_WGB",  SPR_DMR2_WGB  },
{ "DMR2_WBS",  SPR_DMR2_WBS  },
{ NULL,       0               } }

```

**6.26.2.13 struct spr\_bit\_def spr\_drr[] [static]****Initial value:**

```

{
{ "DRR_RSTE", SPR_DRR_RSTE },
{ "DRR_BUSE", SPR_DRR_BUSEE },
{ "DRR_DPFE", SPR_DRR_DPFE },
{ "DRR_IPFE", SPR_DRR_IPFE },
{ "DRR_TTE",  SPR_DRR_TTE  },
{ "DRR_AE",   SPR_DRR_AE   },
{ "DRR_IIE",  SPR_DRR_IIE  },
{ "DRR_IE",   SPR_DRR_IE   },
{ "DRR_DME",  SPR_DRR_DME  },
{ "DRR_IME",  SPR_DRR_IME  },
{ "DRR_RE",   SPR_DRR_RE   },
{ "DRR_SCE",  SPR_DRR_SCE  },
{ "DRR_TE",   SPR_DRR_TE   },
{ NULL, 0 } }

```

**6.26.2.14 struct spr\_bit\_def spr\_dsr[] [static]****Initial value:**



```

{
  { "DSR_RSTE", SPR_DSR_RSTE },
  { "DSR_BUSE", SPR_DSR_BUSEE },
  { "DSR_DPFE", SPR_DSR_DPFE },
  { "DSR_IPFE", SPR_DSR_IPFE },
  { "DSR_TTE", SPR_DSR_TTE },
  { "DSR_AE", SPR_DSR_AE },
  { "DSR_IIE", SPR_DSR_IIE },
  { "DSR_IE", SPR_DSR_IE },
  { "DSR_DME", SPR_DSR_DME },
  { "DSR_IME", SPR_DSR_IME },
  { "DSR_RE", SPR_DSR_RE },
  { "DSR_SCE", SPR_DSR_SCE },
  { "DSR_FPE", SPR_DSR_FPE },
  { "DSR_TE", SPR_DSR_TE },
  { NULL, 0 } }

```

#### 6.26.2.15 struct spr\_bit\_def spr\_dtlbmr[] [static]

##### Initial value:

```

{
  { "DTLBMR_V", SPR_DTLBMR_V },
  { "DTLBMR_PL1", SPR_DTLBMR_PL1 },
  { "DTLBMR_CID", SPR_DTLBMR_CID },
  { "DTLBMR_LRU", SPR_DTLBMR_LRU },
  { "DTLBMR_VPN", SPR_DTLBMR_VPN },
  { NULL, 0 } }

```

#### 6.26.2.16 struct spr\_bit\_def spr\_dtlbtr[] [static]

##### Initial value:

```

{
  { "DTLBTR_CC", SPR_DTLBTR_CC },
  { "DTLBTR_CI", SPR_DTLBTR_CI },
  { "DTLBTR_WBC", SPR_DTLBTR_WBC },
  { "DTLBTR_WOM", SPR_DTLBTR_WOM },
  { "DTLBTR_A", SPR_DTLBTR_A },
  { "DTLBTR_D", SPR_DTLBTR_D },
  { "DTLBTR_URE", SPR_DTLBTR_URE },
  { "DTLBTR_UWE", SPR_DTLBTR_UWE },
  { "DTLBTR_SRE", SPR_DTLBTR_SRE },
  { "DTLBTR_SWE", SPR_DTLBTR_SWE },
  { "DTLBTR_PPN", SPR_DTLBTR_PPN },
  { NULL, 0 } }

```

#### 6.26.2.17 struct spr\_bit\_def spr\_dwcr[] [static]

##### Initial value:

```

{
  { "DWCR_COUNT", SPR_DWCR_COUNT },
  { "DWCR_MATCH", SPR_DWCR_MATCH },
  { NULL, 0 } }

```

**6.26.2.18 struct spr\_def\* spr\_groups[] [static]****Initial value:**

```
{
  spr_sys_group,
  spr_dmmu_group,
  spr_immu_group,
  spr_dc_group,
  spr_ic_group,
  spr_mac_group,
  spr_d_group,
  spr_pc_group,
  spr_pm_group,
  spr_pic_group,
  spr_tt_group }
```

**6.26.2.19 struct spr\_def spr\_ic\_group[] [static]****Initial value:**

```
{
  { 0x000, 0x000, "SPR_ICCR", spr_iccr },
  { 0x001, 0x001, "SPR_ICBPR", spr_one_val },
  { 0x002, 0x002, "SPR_ICBFR", spr_one_val },
  { 0x003, 0x003, "SPR_ICBIR", spr_one_val },
  { 0x200, 0x3ff, "SPR_ICR way 0 set %i", spr_one_val },
  { 0x400, 0x5ff, "SPR_ICR way 1 set %i", spr_one_val },
  { 0x600, 0x7ff, "SPR_ICR way 2 set %i", spr_one_val },
  { 0x800, 0x9ff, "SPR_ICR way 3 set %i", spr_one_val },
  { -1, -1, NULL, NULL } }
```

**6.26.2.20 struct spr\_bit\_def spr\_iccfgr[] [static]****Initial value:**

```
{
  { "ICCFGR_NCW", SPR_ICCFGR_NCW },
  { "ICCFGR_NCS", SPR_ICCFGR_NCS },
  { "ICCFGR_CBS", SPR_ICCFGR_CBS },
  { "ICCFGR_CCRI", SPR_ICCFGR_CCRI },
  { "ICCFGR_CBIRI", SPR_ICCFGR_CBIRI },
  { "ICCFGR_CBPRI", SPR_ICCFGR_CBPRI },
  { "ICCFGR_CBLRI", SPR_ICCFGR_CBLRI },
  { NULL, 0 } }
```

**6.26.2.21 struct spr\_bit\_def spr\_iccr[] [static]****Initial value:**

```
{
  { "ICCR_EW", SPR_ICCR_EW },
  { NULL, 0 } }
```

**6.26.2.22 struct spr\_def spr\_immu\_group[]** [static]**Initial value:**

```
{
  { 0, 0, "SPR_IMMUCR", spr_immucr },
  { 0x200, 0x27f, "SPR_ITLBMR way 0 set %i", spr_itlbmr },
  { 0x280, 0x2ff, "SPR_ITLBTR way 0 set %i", spr_itlbtr },
  { 0x300, 0x37f, "SPR_ITLBMR way 1 set %i", spr_itlbmr },
  { 0x380, 0x3ff, "SPR_ITLBTR way 1 set %i", spr_itlbtr },
  { 0x400, 0x47f, "SPR_ITLBMR way 2 set %i", spr_itlbmr },
  { 0x480, 0x4ff, "SPR_ITLBTR way 2 set %i", spr_itlbtr },
  { 0x500, 0x57f, "SPR_ITLBMR way 3 set %i", spr_itlbmr },
  { 0x580, 0x5ff, "SPR_ITLBTR way 3 set %i", spr_itlbtr },
  { -1, -1, NULL, NULL } }
```

**6.26.2.23 struct spr\_bit\_def spr\_immucfgr[]** [static]**Initial value:**

```
{
  { "IMMUCFGR_NTW", SPR_IMMUCFGR_NTW },
  { "IMMUCFGR_NTS", SPR_IMMUCFGR_NTS },
  { "IMMUCFGR_NAE", SPR_IMMUCFGR_NAE },
  { "IMMUCFGR_CRI", SPR_IMMUCFGR_CRI },
  { "IMMUCFGR_PRI", SPR_IMMUCFGR_PRI },
  { "IMMUCFGR_TEIRI", SPR_IMMUCFGR_TEIRI },
  { "IMMUCFGR_HTR", SPR_IMMUCFGR_HTR },
  { NULL, 0 } }
```

**6.26.2.24 struct spr\_bit\_def spr\_immucr[]** [static]**Initial value:**

```
{
  { "IMMUCR_P2S", SPR_IMMUCR_P2S },
  { "IMMUCR_P1S", SPR_IMMUCR_P1S },
  { "IMMUCR_VADDR_WIDTH", SPR_IMMUCR_VADDR_WIDTH },
  { "IMMUCR_PADDR_WIDTH", SPR_IMMUCR_PADDR_WIDTH },
  { NULL, 0 } }
```

**6.26.2.25 struct spr\_bit\_def spr\_itlbmr[]** [static]**Initial value:**

```
{
  { "ITLBMR_V", SPR_ITLBMR_V },
  { "ITLBMR_PL1", SPR_ITLBMR_PL1 },
  { "ITLBMR_CID", SPR_ITLBMR_CID },
  { "ITLBMR_LRU", SPR_ITLBMR_LRU },
  { "ITLBMR_VPN", SPR_ITLBMR_VPN },
  { NULL, 0 } }
```

**6.26.2.26 struct spr\_bit\_def spr\_itlbtr[]** [static]**Initial value:**

```
{
  { "ITLBTR_CC", SPR_ITLBTR_CC },
  { "ITLBTR_CI", SPR_ITLBTR_CI },
  { "ITLBTR_WBC", SPR_ITLBTR_WBC },
  { "ITLBTR_WOM", SPR_ITLBTR_WOM },
  { "ITLBTR_A", SPR_ITLBTR_A },
  { "ITLBTR_D", SPR_ITLBTR_D },
  { "ITLBTR_URE", SPR_ITLBTR_SXE },
  { "ITLBTR_UWE", SPR_ITLBTR_UXE },
  { "ITLBTR_PPN", SPR_ITLBTR_PPN },
  { NULL, 0 } }
```

**6.26.2.27 struct spr\_def spr\_mac\_group[]** [static]**Initial value:**

```
{
  { 0x1, 0x1, "SPR_MACLO", spr_one_val },
  { 0x2, 0x2, "SPR_MACHI", spr_one_val },
  { -1, -1, NULL, NULL } }
```

**6.26.2.28 struct spr\_bit\_def spr\_one\_val[]** [static]**Initial value:**

```
{
  { "", 0xffffffff },
  { NULL, 0 } }
```

**6.26.2.29 struct spr\_def spr\_pc\_group[]** [static]**Initial value:**

```
{
  { 0x00, 0x07, "PCCR", spr_one_val },
  { 0x08, 0x0f, "PCMR", spr_pcmr },
  { -1, -1, NULL, NULL } }
```

**6.26.2.30 struct spr\_bit\_def spr\_pcmr[]** [static]**Initial value:**

```
{
  { "PCMR_CP", SPR_PCMR_CP },
  { "PCMR_UMRA", SPR_PCMR_UMRA },
  { "PCMR_CISM", SPR_PCMR_CISM },
  { "PCMR_CIUUM", SPR_PCMR_CIUUM },
  { "PCMR_LA", SPR_PCMR_LA },
```

```

{ "PCMR_SA", SPR_PCMR_SA },
{ "PCMR_IF", SPR_PCMR_IF },
{ "PCMR_DCM", SPR_PCMR_DCM },
{ "PCMR_ICM", SPR_PCMR_ICM },
{ "PCMR_IFS", SPR_PCMR_IFS },
{ "PCMR_LSUS", SPR_PCMR_LSUS },
{ "PCMR_BS", SPR_PCMR_BS },
{ "PCMR_DTLBM", SPR_PCMR_DTLBM },
{ "PCMR_ITLBM", SPR_PCMR_ITLBM },
{ "PCMR_DDS", SPR_PCMR_DDS },
{ "PCMR_WPE", SPR_PCMR_WPE },
{ NULL, 0 } }

```

### 6.26.2.31 struct spr\_def spr\_pic\_group[] [static]

#### Initial value:

```

{
{ 0, 0, "PICMR", spr_picmr },
{ 2, 2, "PICSR", spr_one_val },
{ -1, -1, NULL, NULL } }

```

### 6.26.2.32 struct spr\_bit\_def spr\_picmr[] [static]

#### Initial value:

```

{
{ "PICMR_IUM", SPR_PICMR_IUM },
{ NULL, 0 } }

```

### 6.26.2.33 struct spr\_def spr\_pm\_group[] [static]

#### Initial value:

```

{
{ 0x0, 0x0, "SPR_PMR", spr_pmr },
{ -1, -1, NULL, NULL } }

```

### 6.26.2.34 struct spr\_bit\_def spr\_pmr[] [static]

#### Initial value:

```

{
{ "PMR_SDF", SPR_PMR_SDF },
{ "PMR_DME", SPR_PMR_DME },
{ "PMR_SME", SPR_PMR_SME },
{ "PMR_DCGE", SPR_PMR_DCGE },
{ "PMR_SUME", SPR_PMR_SUME },
{ NULL, 0 } }

```

**6.26.2.35 struct spr\_bit\_def spr\_sr[] [static]****Initial value:**

```

{
{ "SR_SM",      SPR_SR_SM      },
{ "SR_TEE",    SPR_SR_TEE     },
{ "SR_IEE",    SPR_SR_IEE     },
{ "SR_DCE",    SPR_SR_DCE     },
{ "SR_ICE",    SPR_SR_ICE     },
{ "SR_DME",    SPR_SR_DME     },
{ "SR_IME",    SPR_SR_IME     },
{ "SR_LEE",    SPR_SR_IME     },
{ "SR_CE",     SPR_SR_CE      },
{ "SR_F",      SPR_SR_F       },
{ "SR_CY",     SPR_SR_CY      },
{ "SR_OV",     SPR_SR_OV      },
{ "SR_OVE",    SPR_SR_OVE     },
{ "SR_DSX",    SPR_SR_DSX     },
{ "SR_EPH",    SPR_SR_EPH     },
{ "SR_FO",     SPR_SR_FO      },
{ "SR_SUMRA",  SPR_SR_SUMRA   },
{ "SR_RES",    SPR_SR_RES     },
{ "SR_CID",    SPR_SR_CID     },
{ NULL,        0              } }

```

**6.26.2.36 struct spr\_def spr\_sys\_group[] [static]****Initial value:**

```

{
{ 0x000, 0x000, "SPR_VR",      spr_vr      },
{ 0x001, 0x001, "SPR_UPR",    spr_upr    },
{ 0x002, 0x002, "SPR_CPUCFGR", spr_cpucfgr },
{ 0x003, 0x003, "SPR_DMMUCFGR", spr_dmmucfgr },
{ 0x004, 0x004, "SPR_IMMUCFGR", spr_immucfgr },
{ 0x005, 0x005, "SPR_DCCFGR",  spr_dccfgr  },
{ 0x006, 0x006, "SPR_ICCFGR",  spr_iccfgr  },
{ 0x007, 0x007, "SPR_DCFGR",   spr_dcfgr   },
{ 0x010, 0x010, "SPR_NPC",     spr_one_val },
{ 0x011, 0x011, "SPR_SR",     spr_sr      },
{ 0x012, 0x012, "SPR_PPC",     spr_one_val },
{ 0x020, 0x02f, "SPR_EPCR(%i)", spr_one_val },
{ 0x030, 0x03f, "SPR_EEAR(%i)", spr_one_val },
{ 0x040, 0x04f, "SPR_ESR(%i)", spr_sr      },
{ 0x400, 0x41f, "GPR(%i)",     spr_one_val },
{ -1,    -1,    NULL,          NULL       } }

```

**6.26.2.37 struct spr\_def spr\_tt\_group[] [static]****Initial value:**

```

{
{ 0, 0, "TTMR", spr_ttmr },
{ 0, 0, "TTCR", spr_one_val },
{ -1, -1, NULL, NULL } }

```

**6.26.2.38 struct spr\_bit\_def spr\_ttmr[]** [static]**Initial value:**

```
{
{ "TTMR_PERIOD", SPR_TTMR_PERIOD },
{ "TTMR_IP", SPR_TTMR_IP },
{ "TTMR_IE", SPR_TTMR_IE },
{ "TTMR_M", SPR_TTMR_M },
{ NULL, 0 } }
```

**6.26.2.39 struct spr\_bit\_def spr\_upr[]** [static]**Initial value:**

```
{
{ "UPR_UP", SPR_UPR_UP },
{ "UPR_DCP", SPR_UPR_DCP },
{ "UPR_ICP", SPR_UPR_ICP },
{ "UPR_DMP", SPR_UPR_DMP },
{ "UPR_IMP", SPR_UPR_IMP },
{ "UPR_MP", SPR_UPR_MP },
{ "UPR_DUP", SPR_UPR_DUP },
{ "UPR_PCUP", SPR_UPR_PCUP },
{ "UPR_PMP", SPR_UPR_PMP },
{ "UPR_PICP", SPR_UPR_PICP },
{ "UPR_TTP", SPR_UPR_TTP },
{ "UPR_RES", SPR_UPR_RES },
{ "UPR_CUP", SPR_UPR_CUP },
{ NULL, 0 } }
```

**6.26.2.40 struct spr\_bit\_def spr\_vr[]** [static]**Initial value:**

```
{
{ "VR_VER", SPR_VR_VER },
{ "VR_REV", SPR_VR_REV },
{ NULL, 0 } }
```

## 6.27 cpu/or1k/spr-dump.h File Reference

```
#include <inttypes.h>
```

```
#include "arch.h"
```

Include dependency graph for spr-dump.h:

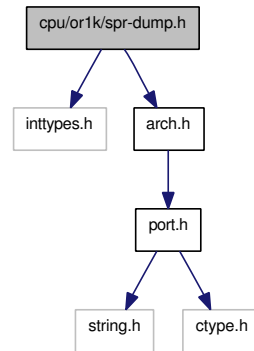

This graph shows which files directly or indirectly include this file:

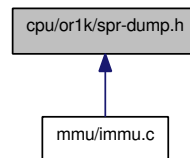

### Functions

- `char * dump_spr (uint16_t spr, uorreg_t spr_val)`

#### 6.27.1 Function Documentation

##### 6.27.1.1 `char* dump_spr (uint16_t spr, uorreg_t spr_val)`



## 6.28 cpu/or1k/sprs.c File Reference

```
#include "config.h"
#include "port.h"
#include <stdlib.h>
#include <stdio.h>
#include <errno.h>
#include "sprs.h"
#include "sim-config.h"
#include "debug.h"
#include "execute.h"
#include "spr-defs.h"
#include "tick.h"
#include "dcache-model.h"
#include "icache-model.h"
#include "dmmu.h"
#include "immu.h"
#include "toplevel-support.h"
#include "pic.h"
```

Include dependency graph for sprs.c:

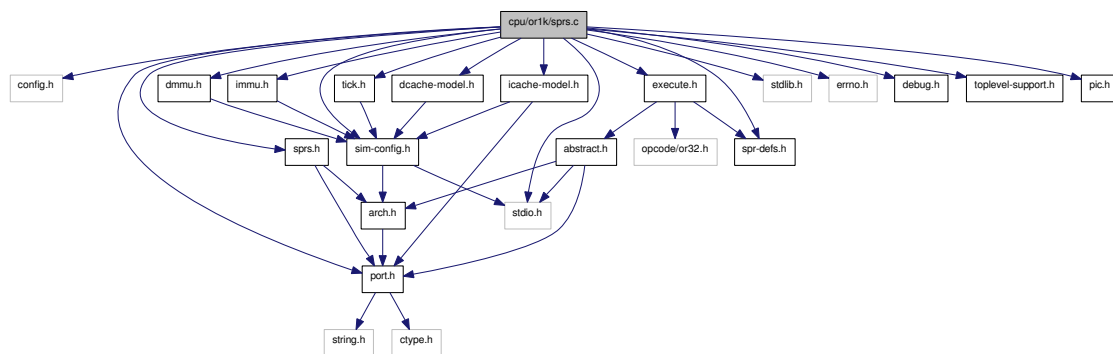

### Functions

- [DECLARE\\_DEBUG\\_CHANNEL](#) ([immu](#))
- void [mfspr](#) ([uint16\\_t](#) regno, const [uorreg\\_t](#) value)
- [uorreg\\_t](#) [mfspr](#) (const [uint16\\_t](#) regno)
- void [sprs\\_status](#) (void)

### Variables

- static int [audio\\_cnt](#) = 0

- static FILE \* fo = 0

## 6.28.1 Function Documentation

### 6.28.1.1 DECLARE\_DEBUG\_CHANNEL (immu)

### 6.28.1.2 uorreg\_t mfspr (const uint16\_t regno)

Here is the call graph for this function:



### 6.28.1.3 void mtspr (uint16\_t regno, const uorreg\_t value)

Here is the call graph for this function:

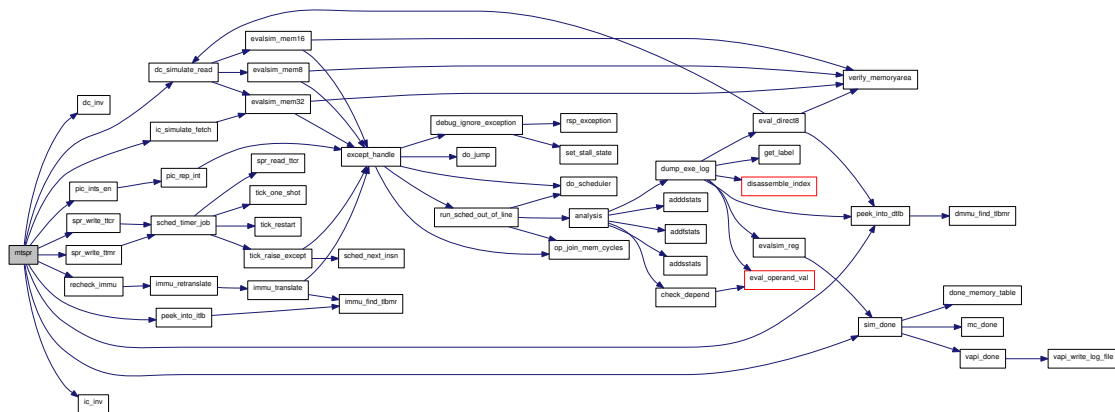

### 6.28.1.4 void sprs\_status (void)

## 6.28.2 Variable Documentation

### 6.28.2.1 int audio\_cnt = 0 [static]

### 6.28.2.2 FILE\* fo = 0 [static]

## 6.29 cpu/or1k/sprs.h File Reference

```
#include "port.h"
```

```
#include "arch.h"
```

Include dependency graph for sprs.h:

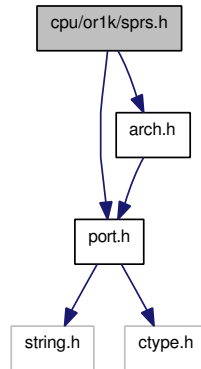

This graph shows which files directly or indirectly include this file:

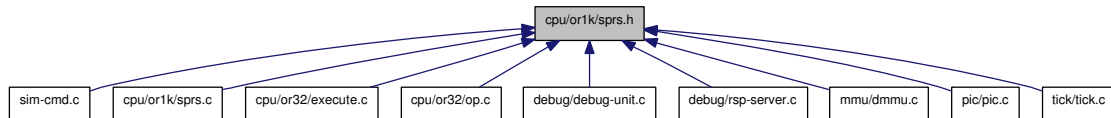

## Functions

- void `mtspr` (uint16\_t regno, const `uorreg_t` value)
- `uorreg_t` `mfspr` (const uint16\_t regno)
- void `sprs_status` ()
- char \* `dump_spr` (uint16\_t spr, `uorreg_t` spr\_val)

### 6.29.1 Function Documentation

#### 6.29.1.1 char\* `dump_spr` (uint16\_t *spr*, `uorreg_t` *spr\_val*)

Here is the call graph for this function:



### 6.29.1.2 uorreg\_t mfspr (const uint16\_t regno)

Here is the call graph for this function:



### 6.29.1.3 void mtspr (uint16\_t regno, const uorreg\_t value)

Here is the call graph for this function:

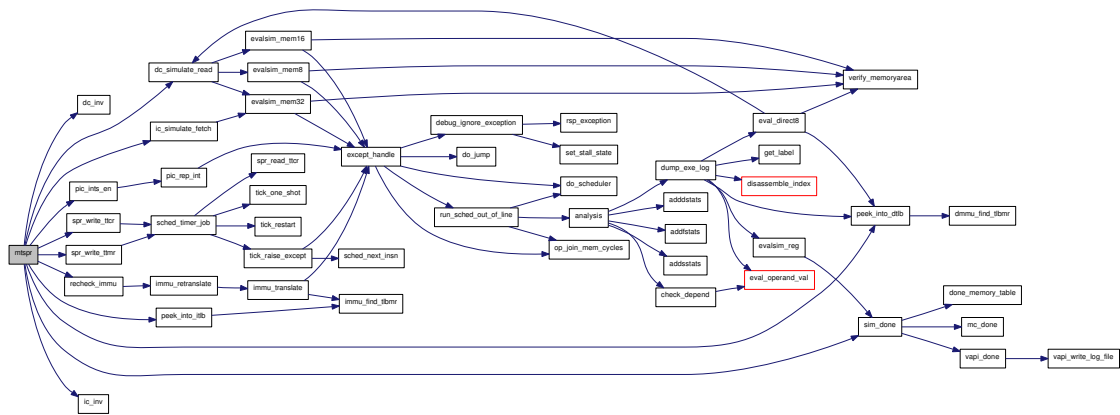

### 6.29.1.4 void sprs\_status ()

## 6.30 cpu/or32/common-i386.h File Reference

### Functions

- static void `set_pc` (`oraddr_t pc`)
- static `oraddr_t get_pc` (`void`)
- static void `upd_sim_cycles` (`void`)

### Variables

- union {
  - struct {
    - `uint32_t low32`
    - `uint32_t high32`
  - } `val3232`
  - `uint64_t val64`
  - } `useless_x86`

### 6.30.1 Function Documentation

**6.30.1.1** `static oraddr_t get_pc (void)` [static]

**6.30.1.2** `static void set_pc (oraddr_t pc)` [static]

**6.30.1.3** `static void upd_sim_cycles (void)` [static]

### 6.30.2 Variable Documentation

**6.30.2.1** `uint32_t high32`

**6.30.2.2** `uint32_t low32`

**6.30.2.3** `union { ... } useless_x86` [static]

**6.30.2.4** `struct { ... } val3232`

**6.30.2.5** `uint64_t val64`

## 6.31 cpu/or32/def-op-t.h File Reference

This graph shows which files directly or indirectly include this file:

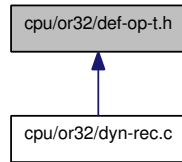

### Defines

- #define [GPR\\_T](#)(op\_name, temp)
- #define [DEF\\_1T\\_OP](#)(type, name, op\_name)
- #define [DEF\\_2T\\_OP](#)(type, name, op\_name)
- #define [DEF\\_3T\\_OP](#)(type, name, op\_name)
- #define [DEF\\_2T\\_OP\\_NEQ](#)(type, name, op\_name)
- #define [DEF\\_3T\\_OP\\_NEQ](#)(type, name, op\_name)
- #define [DEF\\_GPR\\_OP](#)(type, name, op\_name)

### 6.31.1 Define Documentation

#### 6.31.1.1 #define DEF\_1T\_OP(type, name, op\_name)

##### Value:

```
static const type name[NUM_T_REGS] = \
    OP_ROW(op_name)
```

#### 6.31.1.2 #define DEF\_2T\_OP(type, name, op\_name)

##### Value:

```
static const type name[NUM_T_REGS][NUM_T_REGS] = \
    OP_ROW_COL(op_name)
```

#### 6.31.1.3 #define DEF\_2T\_OP\_NEQ(type, name, op\_name)

##### Value:

```
static const type name[NUM_T_REGS][NUM_T_REGS] = \
    OP_ROW_COL_NEQ(op_name)
```

**6.31.1.4 #define DEF\_3T\_OP(type, name, op\_name)****Value:**

```
static const type name[NUM_T_REGS][NUM_T_REGS][NUM_T_REGS] = \
    OP_ROW_COL_3D(op_name)
```

**6.31.1.5 #define DEF\_3T\_OP\_NEQ(type, name, op\_name)****Value:**

```
static const type name[NUM_T_REGS][NUM_T_REGS][NUM_T_REGS] = \
    OP_ROW_COL_3D_NEQ(op_name)
```

**6.31.1.6 #define DEF\_GPR\_OP(type, name, op\_name)****Value:**

```
static const generic_gen_op name[NUM_T_REGS][32] = \
    GPR_ROW_COL(op_name)
```

**6.31.1.7 #define GPR\_T(op\_name, temp)**

## 6.32 cpu/or32/dyn-rec.c File Reference

```
#include <stdio.h>
#include <stdlib.h>
#include <string.h>
#include <sys/mman.h>
#include <signal.h>
#include <errno.h>
#include <execinfo.h>
#include "config.h"
#include "port.h"
#include "arch.h"
#include "immu.h"
#include "abstract.h"
#include "opcode/or32.h"
#include "spr-defs.h"
#include "execute.h"
#include "except.h"
#include "sim-config.h"
#include "sched.h"
#include "i386-regs.h"
#include "def-op-t.h"
#include "dyn-rec.h"
#include "gen-ops.h"
#include "op-support.h"
#include "toplevel-support.h"
```

Include dependency graph for dyn-rec.c:

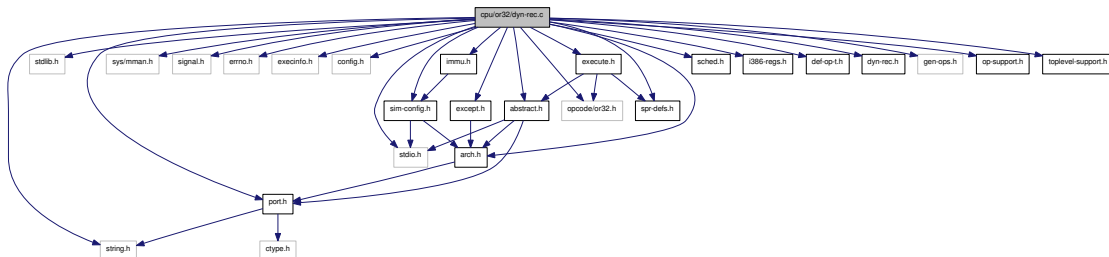

### Defines

- #define [RECED\\_PAGE\\_ENLARGE\\_BY](#) 51200



- #define `OPS_ENLARGE_BY` 5
- #define `T_NONE` (-1)
- #define `TFLAG_SRC` 1
- #define `TFLAG_DST` 2
- #define `TFLAG_SAVED` 4
- #define `TFLAG_SOURCED` 8

## Typedefs

- typedef void(\* `generic_gen_op`)(struct `op_queue` \*opq, int end)
- typedef void(\* `imm_gen_op`)(struct `op_queue` \*opq, int end, `uorreg_t` imm)

## Functions

- void `gen_l_invalid` (struct `op_queue` \*opq, int `param_t`[3], int delay\_slot)
- `DEF_GPR_OP` (`generic_gen_op`, `gen_op_move_gpr_t`, `gen_op_ttg_gpr`)
- `DEF_GPR_OP` (`generic_gen_op`, `gen_op_move_t_gpr`, `gen_op_gtt_gpr`)
- `DEF_1T_OP` (`imm_gen_op`, `calc_insn_ea_table`, `gen_op_calc_insn_ea`)
- void `dyn_ret_stack_prot` (void)
- void `dyn_sigsegv_debug` (int u, `siginfo_t` \*siginf, void \*dat)
- struct `dyn_page` \* `new_dp` (`oraddr_t` page)
- void `dyn_main` (void)
- static void `immu_retranslate` (void \*dat)
- void `recheck_immu` (int got\_en\_dis)
- void `run_sched_out_of_line` (void)
- static void `dirtyfy_page` (struct `dyn_page` \*dp)
- void `dyn_checkwrite` (`oraddr_t` addr)
- static void `ship_t_out` (struct `op_queue` \*opq, unsigned int t)
- static void `ship_gprs_out_t` (struct `op_queue` \*opq)
- static int `find_t` (struct `op_queue` \*opq, unsigned int reg)
- void \* `enough_host_page` (struct `dyn_page` \*dp, void \*cur, unsigned int \*len, unsigned int amount)
- void `add_to_opq` (struct `op_queue` \*opq, int end, int op)
- static void `gen_op_mark_loc` (struct `op_queue` \*opq, int end)
- void `add_to_op_params` (struct `op_queue` \*opq, int end, unsigned long param)
- void `init_dyn_recomp` (void)
- static void `eval_insn_ops` (struct `op_queue` \*opq, `oraddr_t` addr)
- static void `recompile_insn` (struct `op_queue` \*opq, int delay\_insn)
- void `recompile_page` (struct `dyn_page` \*dyn)
- static void `recompile_delay_insn` (struct `op_queue` \*opq)
- static int `find_jump_loc` (`oraddr_t` j\_ea, struct `op_queue` \*opq)
- static void `gen_j_imm` (struct `op_queue` \*opq, `oraddr_t` off)
- static void `gen_j_reg` (struct `op_queue` \*opq, unsigned int gpr)
- `DEF_1T_OP` (`generic_gen_op`, `clear_t`, `gen_op_clear`)
- `DEF_2T_OP_NEQ` (`generic_gen_op`, `move_t_t`, `gen_op_move`)
- `DEF_1T_OP` (`imm_gen_op`, `mov_t_imm`, `gen_op_imm`)
- `DEF_2T_OP` (`imm_gen_op`, `l_add_imm_t_table`, `gen_op_add_imm`)
- `DEF_3T_OP` (`generic_gen_op`, `l_add_t_table`, `gen_op_add`)
- void `gen_l_add` (struct `op_queue` \*opq, int `param_t`[3], int delay\_slot)
- `DEF_3T_OP` (`generic_gen_op`, `l_addc_t_table`, `gen_op_addc`)

- void `gen_l_addc` (struct `op_queue` \*opq, int `param_t`[3], int `delay_slot`)
- `DEF_2T_OP` (`imm_gen_op`, `l_and_imm_t_table`, `gen_op_and_imm`)
- `DEF_3T_OP_NEQ` (`generic_gen_op`, `l_and_t_table`, `gen_op_and`)
- void `gen_l_and` (struct `op_queue` \*opq, int `param_t`[3], int `delay_slot`)
- void `gen_l_bf` (struct `op_queue` \*opq, int `param_t`[3], int `delay_slot`)
- void `gen_l_bnf` (struct `op_queue` \*opq, int `param_t`[3], int `delay_slot`)
- `DEF_3T_OP_NEQ` (`generic_gen_op`, `l_cmov_t_table`, `gen_op_cmov`)
- void `gen_l_cmov` (struct `op_queue` \*opq, int `param_t`[3], int `delay_slot`)
- void `gen_l_cust1` (struct `op_queue` \*opq, int `param_t`[3], int `delay_slot`)
- void `gen_l_cust2` (struct `op_queue` \*opq, int `param_t`[3], int `delay_slot`)
- void `gen_l_cust3` (struct `op_queue` \*opq, int `param_t`[3], int `delay_slot`)
- void `gen_l_cust4` (struct `op_queue` \*opq, int `param_t`[3], int `delay_slot`)
- void `gen_l_cust5` (struct `op_queue` \*opq, int `param_t`[3], int `delay_slot`)
- void `gen_l_cust6` (struct `op_queue` \*opq, int `param_t`[3], int `delay_slot`)
- void `gen_l_cust7` (struct `op_queue` \*opq, int `param_t`[3], int `delay_slot`)
- void `gen_l_cust8` (struct `op_queue` \*opq, int `param_t`[3], int `delay_slot`)
- `DEF_1T_OP` (`generic_gen_op`, `check_null_except`, `gen_op_check_null_except`)
- `DEF_1T_OP` (`generic_gen_op`, `check_null_except_delay`, `gen_op_check_null_except_delay`)
- `DEF_3T_OP` (`generic_gen_op`, `l_div_t_table`, `gen_op_div`)
- void `gen_l_div` (struct `op_queue` \*opq, int `param_t`[3], int `delay_slot`)
- `DEF_3T_OP` (`generic_gen_op`, `l_divu_t_table`, `gen_op_divu`)
- void `gen_l_divu` (struct `op_queue` \*opq, int `param_t`[3], int `delay_slot`)
- `DEF_2T_OP` (`generic_gen_op`, `l_extbs_t_table`, `gen_op_extbs`)
- void `gen_l_extbs` (struct `op_queue` \*opq, int `param_t`[3], int `delay_slot`)
- `DEF_2T_OP` (`generic_gen_op`, `l_extbz_t_table`, `gen_op_extbz`)
- void `gen_l_extbz` (struct `op_queue` \*opq, int `param_t`[3], int `delay_slot`)
- `DEF_2T_OP` (`generic_gen_op`, `l_exths_t_table`, `gen_op_exths`)
- void `gen_l_exths` (struct `op_queue` \*opq, int `param_t`[3], int `delay_slot`)
- `DEF_2T_OP` (`generic_gen_op`, `l_exthz_t_table`, `gen_op_exthz`)
- void `gen_l_exthz` (struct `op_queue` \*opq, int `param_t`[3], int `delay_slot`)
- void `gen_l_extws` (struct `op_queue` \*opq, int `param_t`[3], int `delay_slot`)
- void `gen_l_extwz` (struct `op_queue` \*opq, int `param_t`[3], int `delay_slot`)
- `DEF_2T_OP` (`generic_gen_op`, `l_ff1_t_table`, `gen_op_ff1`)
- void `gen_l_ff1` (struct `op_queue` \*opq, int `param_t`[3], int `delay_slot`)
- void `gen_l_j` (struct `op_queue` \*opq, int `param_t`[3], int `delay_slot`)
- void `gen_l_jal` (struct `op_queue` \*opq, int `param_t`[3], int `delay_slot`)
- void `gen_l_jr` (struct `op_queue` \*opq, int `param_t`[3], int `delay_slot`)
- void `gen_l_jalr` (struct `op_queue` \*opq, int `param_t`[3], int `delay_slot`)
- `DEF_1T_OP` (`imm_gen_op`, `l_lbs_imm_t_table`, `gen_op_lbs_imm`)
- `DEF_2T_OP` (`imm_gen_op`, `l_lbs_t_table`, `gen_op_lbs`)
- void `gen_l_lbs` (struct `op_queue` \*opq, int `param_t`[3], int `delay_slot`)
- `DEF_1T_OP` (`imm_gen_op`, `l_lbz_imm_t_table`, `gen_op_lbz_imm`)
- `DEF_2T_OP` (`imm_gen_op`, `l_lbz_t_table`, `gen_op_lbz`)
- void `gen_l_lbz` (struct `op_queue` \*opq, int `param_t`[3], int `delay_slot`)
- `DEF_1T_OP` (`imm_gen_op`, `l_lhs_imm_t_table`, `gen_op_lhs_imm`)
- `DEF_2T_OP` (`imm_gen_op`, `l_lhs_t_table`, `gen_op_lhs`)
- void `gen_l_lhs` (struct `op_queue` \*opq, int `param_t`[3], int `delay_slot`)
- `DEF_1T_OP` (`imm_gen_op`, `l_lhz_imm_t_table`, `gen_op_lhz_imm`)
- `DEF_2T_OP` (`imm_gen_op`, `l_lhz_t_table`, `gen_op_lhz`)
- void `gen_l_lhz` (struct `op_queue` \*opq, int `param_t`[3], int `delay_slot`)

- DEF\_1T\_OP (imm\_gen\_op, l\_lws\_imm\_t\_table, gen\_op\_lws\_imm)
- DEF\_2T\_OP (imm\_gen\_op, l\_lws\_t\_table, gen\_op\_lws)
- void gen\_l\_lws (struct op\_queue \*opq, int param\_t[3], int delay\_slot)
- DEF\_1T\_OP (imm\_gen\_op, l\_lwz\_imm\_t\_table, gen\_op\_lwz\_imm)
- DEF\_2T\_OP (imm\_gen\_op, l\_lwz\_t\_table, gen\_op\_lwz)
- void gen\_l\_lwz (struct op\_queue \*opq, int param\_t[3], int delay\_slot)
- DEF\_1T\_OP (imm\_gen\_op, l\_mac\_imm\_t\_table, gen\_op\_mac\_imm)
- DEF\_2T\_OP (generic\_gen\_op, l\_mac\_t\_table, gen\_op\_mac)
- void gen\_l\_mac (struct op\_queue \*opq, int param\_t[3], int delay\_slot)
- DEF\_1T\_OP (generic\_gen\_op, l\_macrc\_t\_table, gen\_op\_macrc)
- void gen\_l\_macrc (struct op\_queue \*opq, int param\_t[3], int delay\_slot)
- DEF\_1T\_OP (imm\_gen\_op, l\_mfspr\_imm\_t\_table, gen\_op\_mfspr\_imm)
- DEF\_2T\_OP (imm\_gen\_op, l\_mfspr\_t\_table, gen\_op\_mfspr)
- void gen\_l\_mfspr (struct op\_queue \*opq, int param\_t[3], int delay\_slot)
- void gen\_l\_movhi (struct op\_queue \*opq, int param\_t[3], int delay\_slot)
- DEF\_2T\_OP (generic\_gen\_op, l\_msb\_t\_table, gen\_op\_msb)
- void gen\_l\_msb (struct op\_queue \*opq, int param\_t[3], int delay\_slot)
- DEF\_1T\_OP (imm\_gen\_op, l\_mtspr\_clear\_t\_table, gen\_op\_mtspr\_clear)
- DEF\_1T\_OP (imm\_gen\_op, l\_mtspr\_imm\_t\_table, gen\_op\_mtspr\_imm)
- DEF\_2T\_OP (imm\_gen\_op, l\_mtspr\_t\_table, gen\_op\_mtspr)
- void gen\_l\_mtspr (struct op\_queue \*opq, int param\_t[3], int delay\_slot)
- DEF\_2T\_OP (imm\_gen\_op, l\_mul\_imm\_t\_table, gen\_op\_mul\_imm)
- DEF\_3T\_OP (generic\_gen\_op, l\_mul\_t\_table, gen\_op\_mul)
- void gen\_l\_mul (struct op\_queue \*opq, int param\_t[3], int delay\_slot)
- DEF\_3T\_OP (generic\_gen\_op, l\_mulu\_t\_table, gen\_op\_mulu)
- void gen\_l\_mulu (struct op\_queue \*opq, int param\_t[3], int delay\_slot)
- void gen\_l\_nop (struct op\_queue \*opq, int param\_t[3], int delay\_slot)
- DEF\_2T\_OP (imm\_gen\_op, l\_or\_imm\_t\_table, gen\_op\_or\_imm)
- DEF\_3T\_OP\_NEQ (generic\_gen\_op, l\_or\_t\_table, gen\_op\_or)
- void gen\_l\_or (struct op\_queue \*opq, int param\_t[3], int delay\_slot)
- void gen\_l\_rfe (struct op\_queue \*opq, int param\_t[3], int delay\_slot)
- DEF\_1T\_OP (imm\_gen\_op, l\_sb\_clear\_table, gen\_op\_sb\_clear)
- DEF\_1T\_OP (imm\_gen\_op, l\_sb\_imm\_t\_table, gen\_op\_sb\_imm)
- DEF\_2T\_OP (imm\_gen\_op, l\_sb\_t\_table, gen\_op\_sb)
- void gen\_l\_sb (struct op\_queue \*opq, int param\_t[3], int delay\_slot)
- DEF\_1T\_OP (imm\_gen\_op, l\_sh\_clear\_table, gen\_op\_sh\_clear)
- DEF\_1T\_OP (imm\_gen\_op, l\_sh\_imm\_t\_table, gen\_op\_sh\_imm)
- DEF\_2T\_OP (imm\_gen\_op, l\_sh\_t\_table, gen\_op\_sh)
- void gen\_l\_sh (struct op\_queue \*opq, int param\_t[3], int delay\_slot)
- DEF\_1T\_OP (imm\_gen\_op, l\_sw\_clear\_table, gen\_op\_sw\_clear)
- DEF\_1T\_OP (imm\_gen\_op, l\_sw\_imm\_t\_table, gen\_op\_sw\_imm)
- DEF\_2T\_OP (imm\_gen\_op, l\_sw\_t\_table, gen\_op\_sw)
- void gen\_l\_sw (struct op\_queue \*opq, int param\_t[3], int delay\_slot)
- DEF\_1T\_OP (generic\_gen\_op, l\_sfeq\_null\_t\_table, gen\_op\_sfeq\_null)
- DEF\_1T\_OP (imm\_gen\_op, l\_sfeq\_imm\_t\_table, gen\_op\_sfeq\_imm)
- DEF\_2T\_OP (generic\_gen\_op, l\_sfeq\_t\_table, gen\_op\_sfeq)
- void gen\_l\_sfeq (struct op\_queue \*opq, int param\_t[3], int delay\_slot)
- DEF\_1T\_OP (generic\_gen\_op, l\_sfges\_null\_t\_table, gen\_op\_sfges\_null)
- DEF\_1T\_OP (generic\_gen\_op, l\_sfles\_null\_t\_table, gen\_op\_sfles\_null)
- DEF\_1T\_OP (imm\_gen\_op, l\_sfges\_imm\_t\_table, gen\_op\_sfges\_imm)

- DEF\_2T\_OP (generic\_gen\_op, l\_sfges\_t\_table, gen\_op\_sfges)
- void gen\_l\_sfges (struct op\_queue \*opq, int param\_t[3], int delay\_slot)
- DEF\_1T\_OP (generic\_gen\_op, l\_sfgeu\_null\_t\_table, gen\_op\_sfgeu\_null)
- DEF\_1T\_OP (generic\_gen\_op, l\_sfleu\_null\_t\_table, gen\_op\_sfleu\_null)
- DEF\_1T\_OP (imm\_gen\_op, l\_sfgeu\_imm\_t\_table, gen\_op\_sfgeu\_imm)
- DEF\_2T\_OP (generic\_gen\_op, l\_sfgeu\_t\_table, gen\_op\_sfgeu)
- void gen\_l\_sfgeu (struct op\_queue \*opq, int param\_t[3], int delay\_slot)
- DEF\_1T\_OP (generic\_gen\_op, l\_sfgts\_null\_t\_table, gen\_op\_sfgts\_null)
- DEF\_1T\_OP (generic\_gen\_op, l\_sflts\_null\_t\_table, gen\_op\_sflts\_null)
- DEF\_1T\_OP (imm\_gen\_op, l\_sfgts\_imm\_t\_table, gen\_op\_sfgts\_imm)
- DEF\_2T\_OP (generic\_gen\_op, l\_sfgts\_t\_table, gen\_op\_sfgts)
- void gen\_l\_sfgts (struct op\_queue \*opq, int param\_t[3], int delay\_slot)
- DEF\_1T\_OP (generic\_gen\_op, l\_sfgtu\_null\_t\_table, gen\_op\_sfgtu\_null)
- DEF\_1T\_OP (generic\_gen\_op, l\_sfltu\_null\_t\_table, gen\_op\_sfltu\_null)
- DEF\_1T\_OP (imm\_gen\_op, l\_sfgtu\_imm\_t\_table, gen\_op\_sfgtu\_imm)
- DEF\_2T\_OP (generic\_gen\_op, l\_sfgtu\_t\_table, gen\_op\_sfgtu)
- void gen\_l\_sfgtu (struct op\_queue \*opq, int param\_t[3], int delay\_slot)
- DEF\_1T\_OP (imm\_gen\_op, l\_sfles\_imm\_t\_table, gen\_op\_sfles\_imm)
- DEF\_2T\_OP (generic\_gen\_op, l\_sfles\_t\_table, gen\_op\_sfles)
- void gen\_l\_sfles (struct op\_queue \*opq, int param\_t[3], int delay\_slot)
- DEF\_1T\_OP (imm\_gen\_op, l\_sfleu\_imm\_t\_table, gen\_op\_sfleu\_imm)
- DEF\_2T\_OP (generic\_gen\_op, l\_sfleu\_t\_table, gen\_op\_sfleu)
- void gen\_l\_sfleu (struct op\_queue \*opq, int param\_t[3], int delay\_slot)
- DEF\_1T\_OP (imm\_gen\_op, l\_sflts\_imm\_t\_table, gen\_op\_sflts\_imm)
- DEF\_2T\_OP (generic\_gen\_op, l\_sflts\_t\_table, gen\_op\_sflts)
- void gen\_l\_sflts (struct op\_queue \*opq, int param\_t[3], int delay\_slot)
- DEF\_1T\_OP (imm\_gen\_op, l\_sfltu\_imm\_t\_table, gen\_op\_sfltu\_imm)
- DEF\_2T\_OP (generic\_gen\_op, l\_sfltu\_t\_table, gen\_op\_sfltu)
- void gen\_l\_sfltu (struct op\_queue \*opq, int param\_t[3], int delay\_slot)
- DEF\_1T\_OP (generic\_gen\_op, l\_sfne\_null\_t\_table, gen\_op\_sfne\_null)
- DEF\_1T\_OP (imm\_gen\_op, l\_sfne\_imm\_t\_table, gen\_op\_sfne\_imm)
- DEF\_2T\_OP (generic\_gen\_op, l\_sfne\_t\_table, gen\_op\_sfne)
- void gen\_l\_sfne (struct op\_queue \*opq, int param\_t[3], int delay\_slot)
- DEF\_2T\_OP (imm\_gen\_op, l\_sll\_imm\_t\_table, gen\_op\_sll\_imm)
- DEF\_3T\_OP (generic\_gen\_op, l\_sll\_t\_table, gen\_op\_sll)
- void gen\_l\_sll (struct op\_queue \*opq, int param\_t[3], int delay\_slot)
- DEF\_2T\_OP (imm\_gen\_op, l\_sra\_imm\_t\_table, gen\_op\_sra\_imm)
- DEF\_3T\_OP (generic\_gen\_op, l\_sra\_t\_table, gen\_op\_sra)
- void gen\_l\_sra (struct op\_queue \*opq, int param\_t[3], int delay\_slot)
- DEF\_2T\_OP (imm\_gen\_op, l\_srl\_imm\_t\_table, gen\_op\_srl\_imm)
- DEF\_3T\_OP (generic\_gen\_op, l\_srl\_t\_table, gen\_op\_srl)
- void gen\_l\_srl (struct op\_queue \*opq, int param\_t[3], int delay\_slot)
- DEF\_2T\_OP (generic\_gen\_op, l\_neg\_t\_table, gen\_op\_neg)
- DEF\_3T\_OP (generic\_gen\_op, l\_sub\_t\_table, gen\_op\_sub)
- void gen\_l\_sub (struct op\_queue \*opq, int param\_t[3], int delay\_slot)
- void gen\_l\_sys (struct op\_queue \*opq, int param\_t[3], int delay\_slot)
- void gen\_l\_trap (struct op\_queue \*opq, int param\_t[3], int delay\_slot)
- DEF\_2T\_OP (imm\_gen\_op, l\_xor\_imm\_t\_table, gen\_op\_xor\_imm)
- DEF\_3T\_OP\_NEQ (generic\_gen\_op, l\_xor\_t\_table, gen\_op\_xor)
- void gen\_l\_xor (struct op\_queue \*opq, int param\_t[3], int delay\_slot)

- void [gen\\_lf\\_add\\_s](#) (struct [op\\_queue](#) \*opq, int [param\\_t](#)[3], int delay\_slot)
- void [gen\\_lf\\_div\\_s](#) (struct [op\\_queue](#) \*opq, int [param\\_t](#)[3], int delay\_slot)
- void [gen\\_lf\\_ftoi\\_s](#) (struct [op\\_queue](#) \*opq, int [param\\_t](#)[3], int delay\_slot)
- void [gen\\_lf\\_itof\\_s](#) (struct [op\\_queue](#) \*opq, int [param\\_t](#)[3], int delay\_slot)
- void [gen\\_lf\\_madd\\_s](#) (struct [op\\_queue](#) \*opq, int [param\\_t](#)[3], int delay\_slot)
- void [gen\\_lf\\_mul\\_s](#) (struct [op\\_queue](#) \*opq, int [param\\_t](#)[3], int delay\_slot)
- void [gen\\_lf\\_rem\\_s](#) (struct [op\\_queue](#) \*opq, int [param\\_t](#)[3], int delay\_slot)
- void [gen\\_lf\\_sfeq\\_s](#) (struct [op\\_queue](#) \*opq, int [param\\_t](#)[3], int delay\_slot)
- void [gen\\_lf\\_sfge\\_s](#) (struct [op\\_queue](#) \*opq, int [param\\_t](#)[3], int delay\_slot)
- void [gen\\_lf\\_sfgt\\_s](#) (struct [op\\_queue](#) \*opq, int [param\\_t](#)[3], int delay\_slot)
- void [gen\\_lf\\_sfle\\_s](#) (struct [op\\_queue](#) \*opq, int [param\\_t](#)[3], int delay\_slot)
- void [gen\\_lf\\_sflt\\_s](#) (struct [op\\_queue](#) \*opq, int [param\\_t](#)[3], int delay\_slot)
- void [gen\\_lf\\_sfne\\_s](#) (struct [op\\_queue](#) \*opq, int [param\\_t](#)[3], int delay\_slot)
- void [gen\\_lf\\_sub\\_s](#) (struct [op\\_queue](#) \*opq, int [param\\_t](#)[3], int delay\_slot)

## Variables

- [uorreg\\_t \\_\\_op\\_param1](#)
- [uorreg\\_t \\_\\_op\\_param2](#)
- [uorreg\\_t \\_\\_op\\_param3](#)
- [int do\\_stats](#)
- [static int sigsegv\\_state = 0](#)
- [static void \\* sigsegv\\_addr = NULL](#)
- [static const generic\\_gen\\_op set\\_pc\\_delay\\_gpr \[32\]](#)



### 6.32.1 Define Documentation

- 6.32.1.1 `#define OPS_ENLARGE_BY 5`
- 6.32.1.2 `#define RECED_PAGE_ENLARGE_BY 51200`
- 6.32.1.3 `#define T_NONE (-1)`
- 6.32.1.4 `#define TFLAG_DST 2`
- 6.32.1.5 `#define TFLAG_SAVED 4`
- 6.32.1.6 `#define TFLAG_SOURCED 8`
- 6.32.1.7 `#define TFLAG_SRC 1`

### 6.32.2 Typedef Documentation

- 6.32.2.1 `typedef void(* generic_gen_op)(struct op_queue *opq, int end)`
- 6.32.2.2 `typedef void(* imm_gen_op)(struct op_queue *opq, int end, uorreg_t imm)`

### 6.32.3 Function Documentation

- 6.32.3.1 `void add_to_op_params (struct op_queue * opq, int end, unsigned long param)`
- 6.32.3.2 `void add_to_opq (struct op_queue * opq, int end, int op)`
- 6.32.3.3 `DEF_1T_OP (imm_gen_op, l_sfne_imm_t_table, gen_op_sfne_imm)`
- 6.32.3.4 `DEF_1T_OP (generic_gen_op, l_sfne_null_t_table, gen_op_sfne_null)`
- 6.32.3.5 `DEF_1T_OP (imm_gen_op, l_sftu_imm_t_table, gen_op_sftu_imm)`
- 6.32.3.6 `DEF_1T_OP (imm_gen_op, l_sfts_imm_t_table, gen_op_sfts_imm)`
- 6.32.3.7 `DEF_1T_OP (imm_gen_op, l_sfleu_imm_t_table, gen_op_sfleu_imm)`
- 6.32.3.8 `DEF_1T_OP (imm_gen_op, l_sfles_imm_t_table, gen_op_sfles_imm)`
- 6.32.3.9 `DEF_1T_OP (imm_gen_op, l_sfgtu_imm_t_table, gen_op_sfgtu_imm)`
- 6.32.3.10 `DEF_1T_OP (generic_gen_op, l_sftu_null_t_table, gen_op_sftu_null)`
- 6.32.3.11 `DEF_1T_OP (generic_gen_op, l_sfgtu_null_t_table, gen_op_sfgtu_null)`
- 6.32.3.12 `DEF_1T_OP (imm_gen_op, l_sfgts_imm_t_table, gen_op_sfgts_imm)`
- 6.32.3.13 `DEF_1T_OP (generic_gen_op, l_sfts_null_t_table, gen_op_sfts_null)`
- 6.32.3.14 `DEF_1T_OP (generic_gen_op, l_sfgts_null_t_table, gen_op_sfgts_null)`
- 6.32.3.15 `DEF_1T_OP (imm_gen_op, l_sfgeu_imm_t_table, gen_op_sfgeu_imm)`
- 6.32.3.16 `DEF_1T_OP (generic_gen_op, l_sfne_null_t_table, gen_op_sfne_null)`
- 6.32.3.17 `DEF_1T_OP (generic_gen_op, l_sfgeu_null_t_table, gen_op_sfgeu_null)`
- 6.32.3.18 `DEF_1T_OP (imm_gen_op, l_sfges_imm_t_table, gen_op_sfges_imm)`
- 6.32.3.19 `DEF_1T_OP (generic_gen_op, l_sfges_null_t_table, gen_op_sfges_null)`







**6.32.3.107** `static int find_t (struct op_queue * opq, unsigned int reg)` [static]

**6.32.3.108** `static void gen_j_imm (struct op_queue * opq, oraddr_t off)` [static]

Here is the call graph for this function:

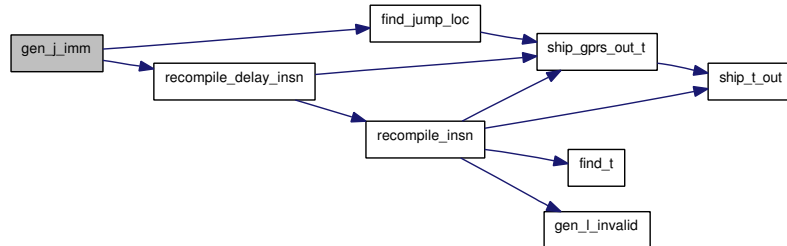

**6.32.3.109** `static void gen_j_reg (struct op_queue * opq, unsigned int gpr)` [static]

Here is the call graph for this function:

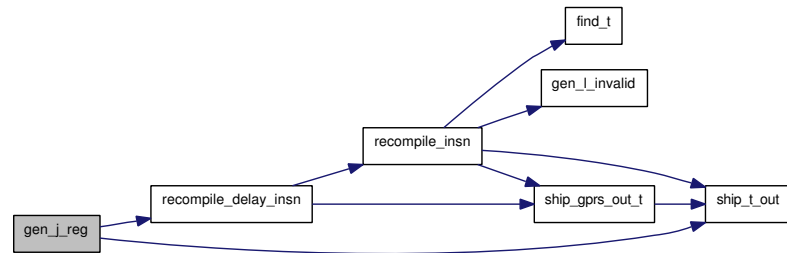

**6.32.3.110** `void gen_l_add (struct op_queue * opq, int param_t[3], int delay_slot)`

**6.32.3.111** `void gen_l_addc (struct op_queue * opq, int param_t[3], int delay_slot)`

**6.32.3.112** `void gen_l_and (struct op_queue * opq, int param_t[3], int delay_slot)`

**6.32.3.113** `void gen_l_bf (struct op_queue * opq, int param_t[3], int delay_slot)`

Here is the call graph for this function:

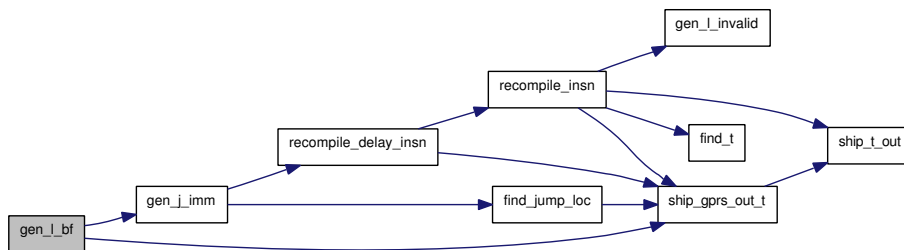

6.32.3.114 void `gen_l_bnf` (`struct op_queue * opq`, `int param_t[3]`, `int delay_slot`)

Here is the call graph for this function:

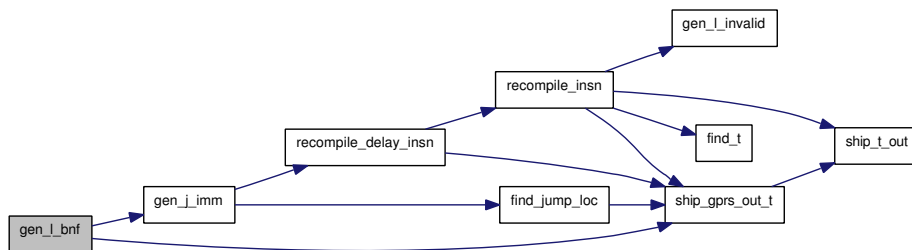

- 6.32.3.115 void `gen_l_cmov` (`struct op_queue * opq`, `int param_t[3]`, `int delay_slot`)
- 6.32.3.116 void `gen_l_cust1` (`struct op_queue * opq`, `int param_t[3]`, `int delay_slot`)
- 6.32.3.117 void `gen_l_cust2` (`struct op_queue * opq`, `int param_t[3]`, `int delay_slot`)
- 6.32.3.118 void `gen_l_cust3` (`struct op_queue * opq`, `int param_t[3]`, `int delay_slot`)
- 6.32.3.119 void `gen_l_cust4` (`struct op_queue * opq`, `int param_t[3]`, `int delay_slot`)
- 6.32.3.120 void `gen_l_cust5` (`struct op_queue * opq`, `int param_t[3]`, `int delay_slot`)
- 6.32.3.121 void `gen_l_cust6` (`struct op_queue * opq`, `int param_t[3]`, `int delay_slot`)
- 6.32.3.122 void `gen_l_cust7` (`struct op_queue * opq`, `int param_t[3]`, `int delay_slot`)
- 6.32.3.123 void `gen_l_cust8` (`struct op_queue * opq`, `int param_t[3]`, `int delay_slot`)
- 6.32.3.124 void `gen_l_div` (`struct op_queue * opq`, `int param_t[3]`, `int delay_slot`)
- 6.32.3.125 void `gen_l_divu` (`struct op_queue * opq`, `int param_t[3]`, `int delay_slot`)
- 6.32.3.126 void `gen_l_extbs` (`struct op_queue * opq`, `int param_t[3]`, `int delay_slot`)
- 6.32.3.127 void `gen_l_extbz` (`struct op_queue * opq`, `int param_t[3]`, `int delay_slot`)
- 6.32.3.128 void `gen_l_exths` (`struct op_queue * opq`, `int param_t[3]`, `int delay_slot`)
- 6.32.3.129 void `gen_l_exthz` (`struct op_queue * opq`, `int param_t[3]`, `int delay_slot`)
- 6.32.3.130 void `gen_l_extws` (`struct op_queue * opq`, `int param_t[3]`, `int delay_slot`)
- 6.32.3.131 void `gen_l_extwz` (`struct op_queue * opq`, `int param_t[3]`, `int delay_slot`)
- 6.32.3.132 void `gen_l_ff1` (`struct op_queue * opq`, `int param_t[3]`, `int delay_slot`)
- 6.32.3.133 void `gen_l_invalid` (`struct op_queue * opq`, `int param_t[3]`, `int delay_slot`)
- 6.32.3.134 void `gen_l_j` (`struct op_queue * opq`, `int param_t[3]`, `int delay_slot`)

Here is the call graph for this function:

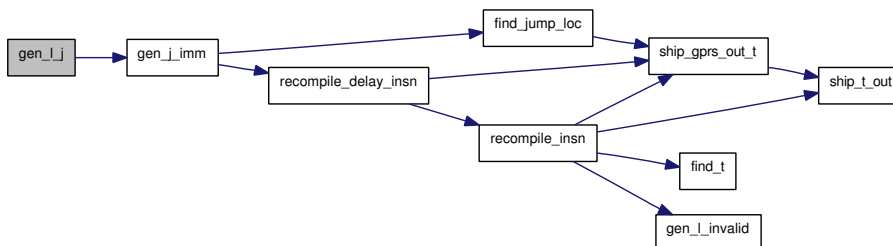

**6.32.3.135 void gen\_l\_jal (struct op\_queue \* opq, int param\_t[3], int delay\_slot)**

Here is the call graph for this function:

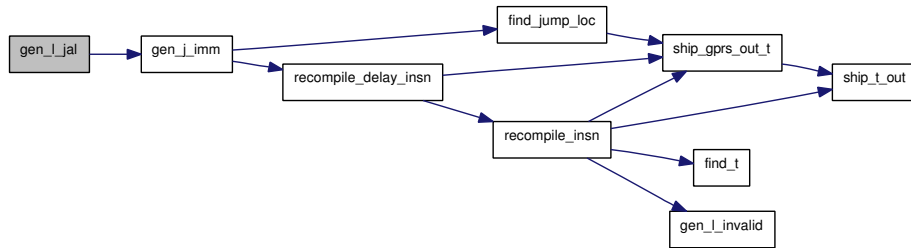
**6.32.3.136 void gen\_l\_jalr (struct op\_queue \* opq, int param\_t[3], int delay\_slot)**

Here is the call graph for this function:

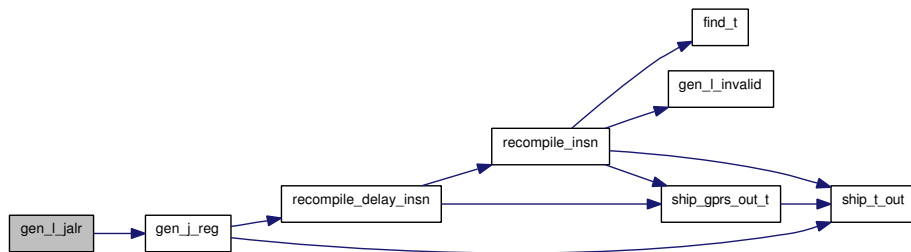
**6.32.3.137 void gen\_l\_jr (struct op\_queue \* opq, int param\_t[3], int delay\_slot)**

Here is the call graph for this function:

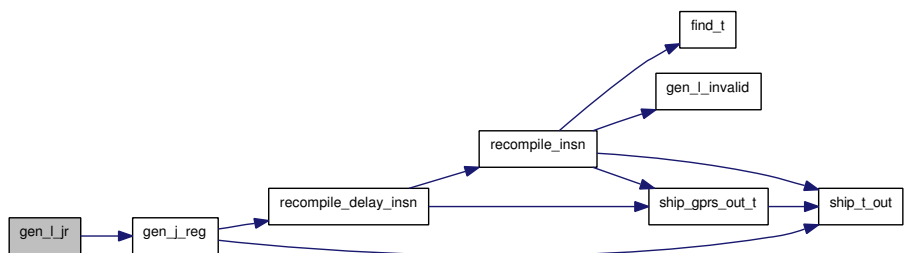
**6.32.3.138 void gen\_l\_lbs (struct op\_queue \* opq, int param\_t[3], int delay\_slot)**

Here is the call graph for this function:

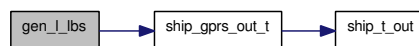

**6.32.3.139 void gen\_l\_lbz (struct op\_queue \* opq, int param\_t[3], int delay\_slot)**

Here is the call graph for this function:

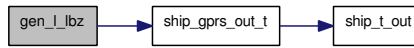
**6.32.3.140 void gen\_l\_lhs (struct op\_queue \* opq, int param\_t[3], int delay\_slot)**

Here is the call graph for this function:

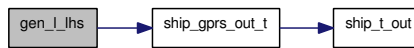
**6.32.3.141 void gen\_l\_lhz (struct op\_queue \* opq, int param\_t[3], int delay\_slot)**

Here is the call graph for this function:

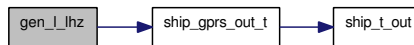
**6.32.3.142 void gen\_l\_lws (struct op\_queue \* opq, int param\_t[3], int delay\_slot)**

Here is the call graph for this function:

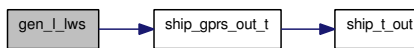
**6.32.3.143 void gen\_l\_lwz (struct op\_queue \* opq, int param\_t[3], int delay\_slot)**

Here is the call graph for this function:

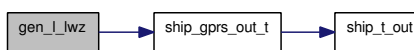

6.32.3.144 void `gen_l_mac` (`struct op_queue * opq`, `int param_t[3]`, `int delay_slot`)

6.32.3.145 void `gen_l_macrc` (`struct op_queue * opq`, `int param_t[3]`, `int delay_slot`)

6.32.3.146 void `gen_l_mfspr` (`struct op_queue * opq`, `int param_t[3]`, `int delay_slot`)

6.32.3.147 void `gen_l_movhi` (`struct op_queue * opq`, `int param_t[3]`, `int delay_slot`)

6.32.3.148 void `gen_l_msb` (`struct op_queue * opq`, `int param_t[3]`, `int delay_slot`)

6.32.3.149 void `gen_l_mtspr` (`struct op_queue * opq`, `int param_t[3]`, `int delay_slot`)

Here is the call graph for this function:

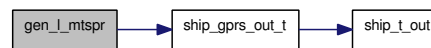

6.32.3.150 void `gen_l_mul` (`struct op_queue * opq`, `int param_t[3]`, `int delay_slot`)

6.32.3.151 void `gen_l_mulu` (`struct op_queue * opq`, `int param_t[3]`, `int delay_slot`)

6.32.3.152 void `gen_l_nop` (`struct op_queue * opq`, `int param_t[3]`, `int delay_slot`)

Here is the call graph for this function:

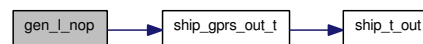

6.32.3.153 void `gen_l_or` (`struct op_queue * opq`, `int param_t[3]`, `int delay_slot`)

6.32.3.154 void `gen_l_rfe` (`struct op_queue * opq`, `int param_t[3]`, `int delay_slot`)

6.32.3.155 void `gen_l_sb` (`struct op_queue * opq`, `int param_t[3]`, `int delay_slot`)

Here is the call graph for this function:

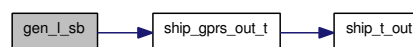

- 6.32.3.156 void gen\_l\_sfeq (struct op\_queue \* opq, int param\_t[3], int delay\_slot)
- 6.32.3.157 void gen\_l\_sfges (struct op\_queue \* opq, int param\_t[3], int delay\_slot)
- 6.32.3.158 void gen\_l\_sfgeu (struct op\_queue \* opq, int param\_t[3], int delay\_slot)
- 6.32.3.159 void gen\_l\_sfgts (struct op\_queue \* opq, int param\_t[3], int delay\_slot)
- 6.32.3.160 void gen\_l\_sfgtu (struct op\_queue \* opq, int param\_t[3], int delay\_slot)
- 6.32.3.161 void gen\_l\_sfles (struct op\_queue \* opq, int param\_t[3], int delay\_slot)
- 6.32.3.162 void gen\_l\_sfleu (struct op\_queue \* opq, int param\_t[3], int delay\_slot)
- 6.32.3.163 void gen\_l\_sfits (struct op\_queue \* opq, int param\_t[3], int delay\_slot)
- 6.32.3.164 void gen\_l\_sftu (struct op\_queue \* opq, int param\_t[3], int delay\_slot)
- 6.32.3.165 void gen\_l\_sfne (struct op\_queue \* opq, int param\_t[3], int delay\_slot)
- 6.32.3.166 void gen\_l\_sh (struct op\_queue \* opq, int param\_t[3], int delay\_slot)

Here is the call graph for this function:

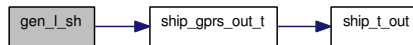

- 6.32.3.167 void gen\_l\_sll (struct op\_queue \* opq, int param\_t[3], int delay\_slot)
- 6.32.3.168 void gen\_l\_sra (struct op\_queue \* opq, int param\_t[3], int delay\_slot)
- 6.32.3.169 void gen\_l\_srl (struct op\_queue \* opq, int param\_t[3], int delay\_slot)
- 6.32.3.170 void gen\_l\_sub (struct op\_queue \* opq, int param\_t[3], int delay\_slot)
- 6.32.3.171 void gen\_l\_sw (struct op\_queue \* opq, int param\_t[3], int delay\_slot)

Here is the call graph for this function:

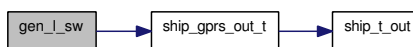



**6.32.3.172** void `gen_l_sys` (struct `op_queue` \* *opq*, int *param\_t*[3], int *delay\_slot*)

**6.32.3.173** void `gen_l_trap` (struct `op_queue` \* *opq*, int *param\_t*[3], int *delay\_slot*)

**6.32.3.174** void `gen_l_xor` (struct `op_queue` \* *opq*, int *param\_t*[3], int *delay\_slot*)

**6.32.3.175** void `gen_lf_add_s` (struct `op_queue` \* *opq*, int *param\_t*[3], int *delay\_slot*)

Here is the call graph for this function:



**6.32.3.176** void `gen_lf_div_s` (struct `op_queue` \* *opq*, int *param\_t*[3], int *delay\_slot*)

Here is the call graph for this function:



**6.32.3.177** void `gen_lf_ftoi_s` (struct `op_queue` \* *opq*, int *param\_t*[3], int *delay\_slot*)

Here is the call graph for this function:



**6.32.3.178** void `gen_lf_itof_s` (struct `op_queue` \* *opq*, int *param\_t*[3], int *delay\_slot*)

Here is the call graph for this function:



**6.32.3.179** void `gen_lf_madd_s` (struct `op_queue` \* *opq*, int *param\_t*[3], int *delay\_slot*)

Here is the call graph for this function:



**6.32.3.180 void gen\_lf\_mul\_s (struct op\_queue \* opq, int param\_t[3], int delay\_slot)**

Here is the call graph for this function:

**6.32.3.181 void gen\_lf\_rem\_s (struct op\_queue \* opq, int param\_t[3], int delay\_slot)**

Here is the call graph for this function:

**6.32.3.182 void gen\_lf\_sfeq\_s (struct op\_queue \* opq, int param\_t[3], int delay\_slot)**

Here is the call graph for this function:

**6.32.3.183 void gen\_lf\_sfge\_s (struct op\_queue \* opq, int param\_t[3], int delay\_slot)**

Here is the call graph for this function:

**6.32.3.184 void gen\_lf\_sfgt\_s (struct op\_queue \* opq, int param\_t[3], int delay\_slot)**

Here is the call graph for this function:

**6.32.3.185 void gen\_lf\_sfle\_s (struct op\_queue \* opq, int param\_t[3], int delay\_slot)**

Here is the call graph for this function:



**6.32.3.186** void `gen_lf_sflt_s` (`struct op_queue * opq`, `int param_t[3]`, `int delay_slot`)

Here is the call graph for this function:



**6.32.3.187** void `gen_lf_sfne_s` (`struct op_queue * opq`, `int param_t[3]`, `int delay_slot`)

Here is the call graph for this function:



**6.32.3.188** void `gen_lf_sub_s` (`struct op_queue * opq`, `int param_t[3]`, `int delay_slot`)

Here is the call graph for this function:



**6.32.3.189** static void `gen_op_mark_loc` (`struct op_queue * opq`, `int end`) [static]

Here is the call graph for this function:



### 6.32.3.190 static void immu\_retranslate (void \* *dat*) [static]

Here is the call graph for this function:

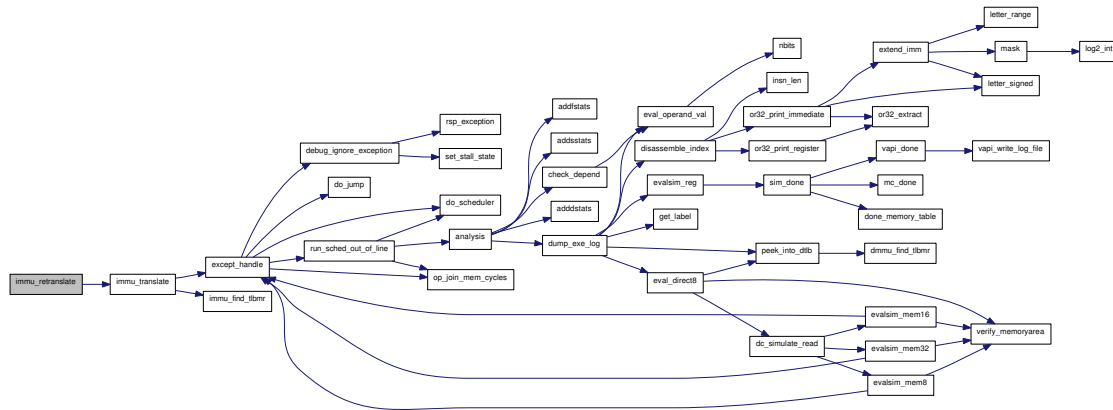

### 6.32.3.191 void init\_dyn\_recomp (void)

Here is the call graph for this function:

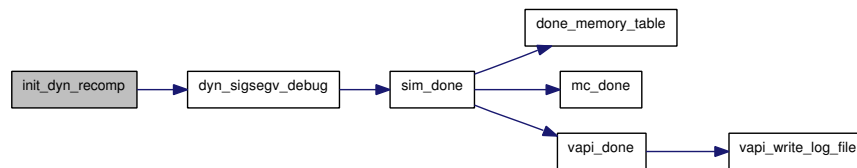

### 6.32.3.192 struct dyn\_page\* new\_dp (oraddr\_t *page*) [read]

### 6.32.3.193 void recheck\_immu (int *got\_en\_dis*)

Here is the call graph for this function:

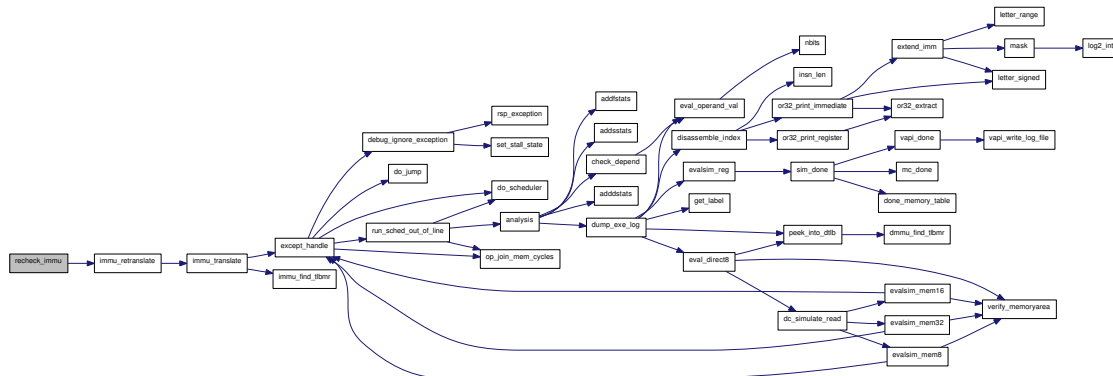

**6.32.3.194** static void recompile\_delay\_insn (struct op\_queue \* opq) [static]

Here is the call graph for this function:

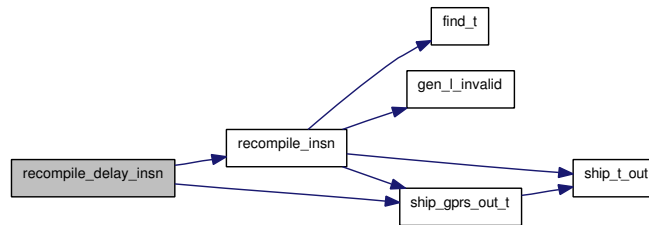
**6.32.3.195** static void recompile\_insn (struct op\_queue \* opq, int delay\_insn) [static]

Here is the call graph for this function:

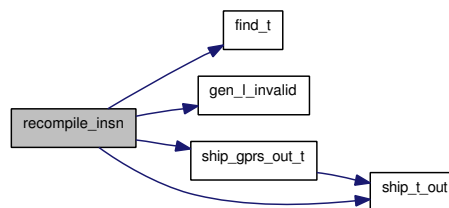
**6.32.3.196** void recompile\_page (struct dyn\_page \* dyn)

Here is the call graph for this function:

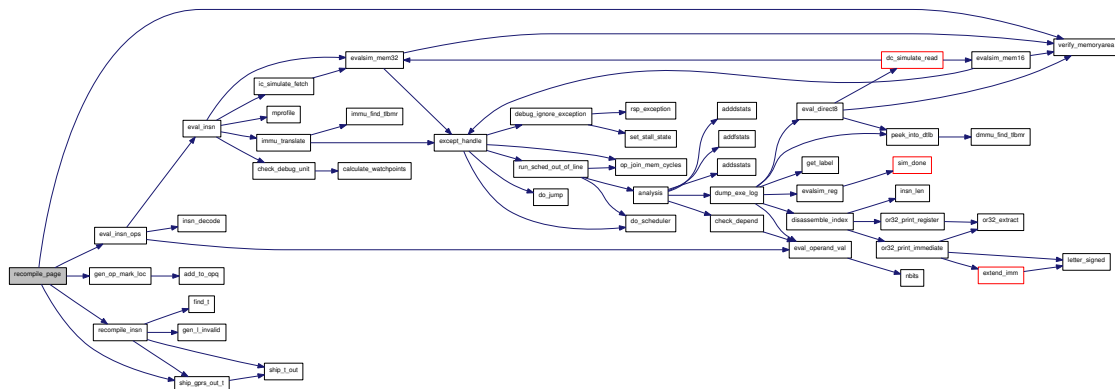

### 6.32.3.197 void run\_sched\_out\_of\_line (void)

Here is the call graph for this function:

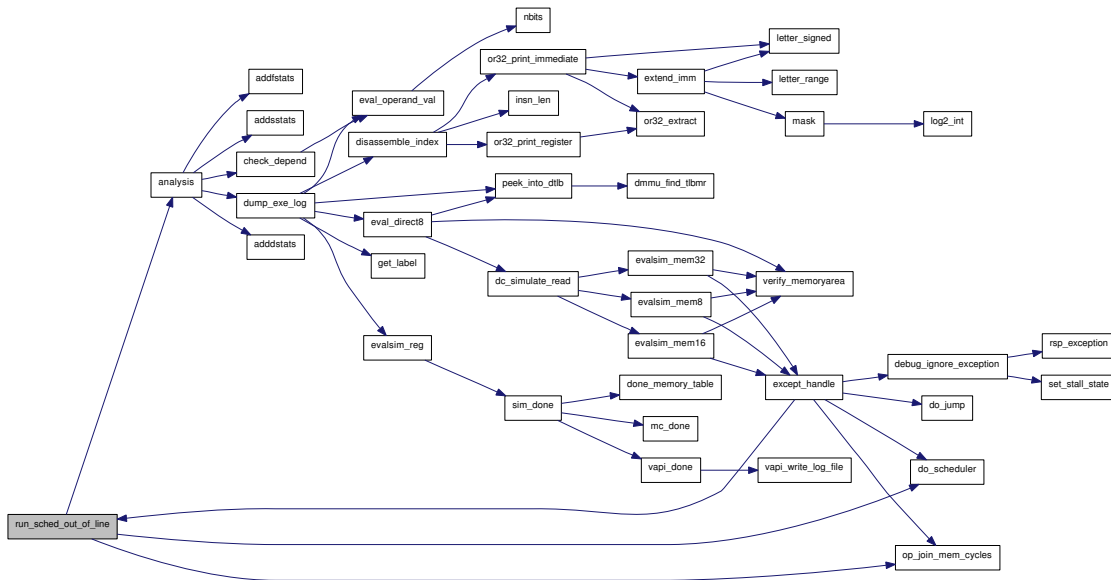

### 6.32.3.198 static void ship\_gprs\_out\_t (struct op\_queue \* opq) [static]

Here is the call graph for this function:

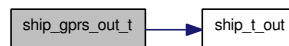

### 6.32.3.199 static void ship\_t\_out (struct op\_queue \* opq, unsigned int t) [static]

## 6.32.4 Variable Documentation

### 6.32.4.1 uorreg\_t \_\_op\_param1

### 6.32.4.2 uorreg\_t \_\_op\_param2

### 6.32.4.3 uorreg\_t \_\_op\_param3

### 6.32.4.4 int do\_stats

Whether we are doing statistical analysis. Globally available

**6.32.4.5** `const generic_gen_op set_pc_delay_gpr[32]` [static]

**6.32.4.6** `void* sigsegv_addr = NULL` [static]

**6.32.4.7** `int sigsegv_state = 0` [static]

## 6.33 cpu/or32/dyn-rec.h File Reference

This graph shows which files directly or indirectly include this file:

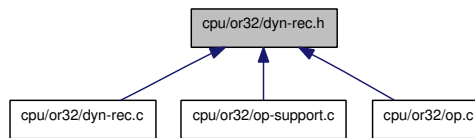

### Data Structures

- struct [dyn\\_page](#)

### Defines

- #define [IMMU\\_GOT\\_ENABLED](#) 1
- #define [IMMU\\_GOT\\_DISABLED](#) 2
- #define [xglue\(x, y\)](#) x ## y
- #define [glue\(x, y\)](#) xglue(x, y)

### Typedefs

- typedef void(\* [gen\\_code\\_ent](#) )(void)

### Functions

- void [recompile\\_page](#) (struct [dyn\\_page](#) \*dyn)
- struct [dyn\\_page](#) \* [new\\_dp](#) (oraddr\_t page)
- void [add\\_to\\_opq](#) (struct [op\\_queue](#) \*opq, int end, int op)
- void [add\\_to\\_op\\_params](#) (struct [op\\_queue](#) \*opq, int end, unsigned long param)
- void \* [enough\\_host\\_page](#) (struct [dyn\\_page](#) \*dp, void \*cur, unsigned int \*len, unsigned int amount)
- void [init\\_dyn\\_recomp](#) (void)
- void [run\\_sched\\_out\\_of\\_line](#) (void)
- void [recheck\\_immu](#) (int got\_en\_dis)
- void [enter\\_dyn\\_code](#) (oraddr\_t addr, struct [dyn\\_page](#) \*dp)
- void [dyn\\_checkwrite](#) (oraddr\_t addr)
- void [dyn\\_main](#) (void)

### Variables

- void \* [rec\\_stack\\_base](#)









### 6.33.3.11 void run\_sched\_out\_of\_line (void)

Here is the call graph for this function:

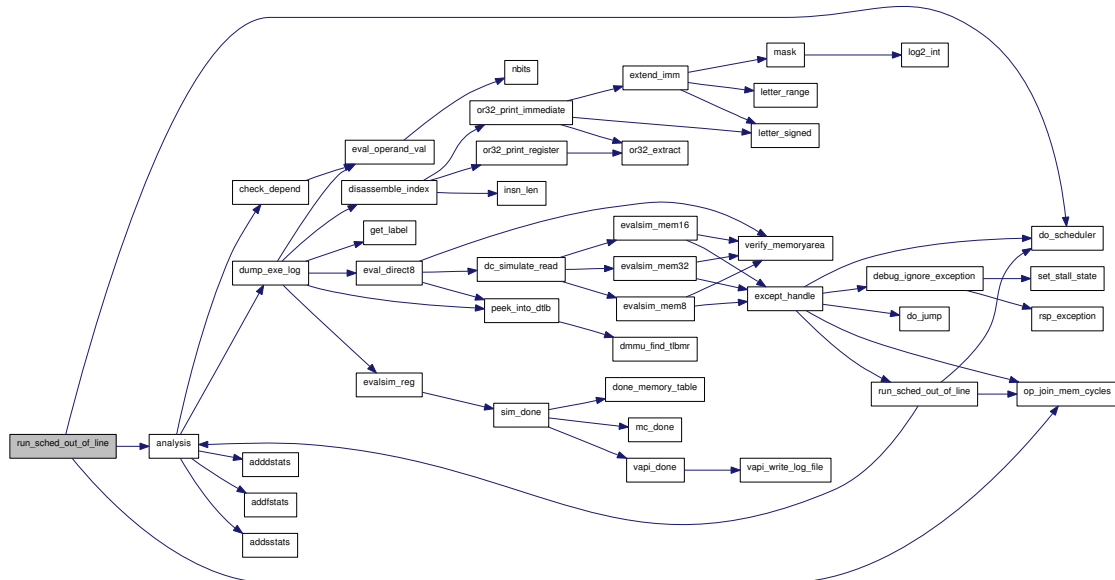

## 6.33.4 Variable Documentation

### 6.33.4.1 void\* rec\_stack\_base

## 6.34 cpu/or32/dyn32-defs.h File Reference

```
#include "arch.h"
```

Include dependency graph for dyn32-defs.h:

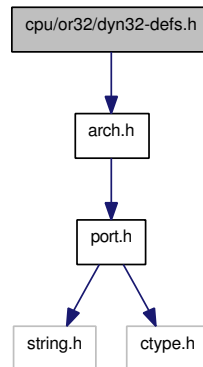

### Data Structures

- struct [op\\_queue](#)

### Functions

- void `gen_l_add` PARAMS ((struct [op\\_queue](#) \*, int \*, int))
- void `l_none` (struct [op\\_queue](#) \*opq, int \*param\_t, int delay\_slot)

#### 6.34.1 Function Documentation

**6.34.1.1** void `l_none` (struct [op\\_queue](#) \* *opq*, int \* *param\_t*, int *delay\_slot*)

**6.34.1.2** void `gen_lf_sub_s` PARAMS ((struct [op\\_queue](#) \*, int \*, int))

## 6.35 cpu/or32/dyngen-elf.c File Reference

```
#include <stdio.h>
#include <stdlib.h>
#include <stdint.h>
#include <assert.h>
#include <elf.h>
#include "dyngen.h"
```

Include dependency graph for dyngen-elf.c:

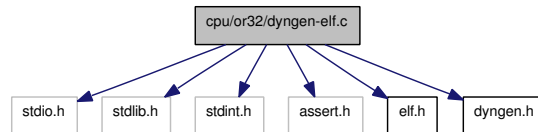

### Data Structures

- struct [elf\\_obj](#)

### Functions

- void \* [elf\\_open\\_obj](#) (const char \*file)
- void [elf\\_close\\_obj](#) (void \*e\_obj)
- static [Elf32\\_Sym](#) \* [elf\\_find\\_func](#) (struct [elf\\_obj](#) \*obj, unsigned int func)
- char \* [elf\\_get\\_func\\_name](#) (void \*e\_obj, unsigned int func)
- unsigned int [elf\\_get\\_func\\_len](#) (void \*e\_obj, unsigned int func)
- void \* [elf\\_get\\_func\\_start](#) (void \*e\_obj, unsigned int func)
- static char \* [elf\\_get\\_sym\\_name](#) (struct [elf\\_obj](#) \*obj, unsigned int sym)
- int [elf\\_get\\_func\\_reloc](#) (void \*e\_obj, unsigned int func, unsigned int relocn, struct [reloc](#) \*reloc)

### Variables

- struct [bff](#) [bffb](#)

### 6.35.1 Function Documentation

**6.35.1.1** void [elf\\_close\\_obj](#) (void \* *e\_obj*)

**6.35.1.2** static [Elf32\\_Sym](#)\* [elf\\_find\\_func](#) (struct [elf\\_obj](#) \* *obj*, unsigned int *func*) [static]

**6.35.1.3** unsigned int [elf\\_get\\_func\\_len](#) (void \* *e\_obj*, unsigned int *func*)

Here is the call graph for this function:



**6.35.1.4** `char* elf_get_func_name (void * e_obj, unsigned int func)`

Here is the call graph for this function:

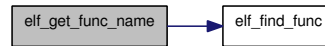
**6.35.1.5** `int elf_get_func_reloc (void * e_obj, unsigned int func, unsigned int relocn, struct reloc * reloc)`

Here is the call graph for this function:

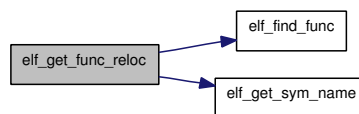
**6.35.1.6** `void* elf_get_func_start (void * e_obj, unsigned int func)`

Here is the call graph for this function:

**6.35.1.7** `static char* elf_get_sym_name (struct elf_obj * obj, unsigned int sym)` [static]**6.35.1.8** `void* elf_open_obj (const char * file)`**6.35.2** Variable Documentation**6.35.2.1** struct bff bffs

**Initial value:**

```

{
  elf_open_obj,
  elf_close_obj,
  elf_get_func_name,
  elf_get_func_start,
  elf_get_func_len,
  elf_get_func_reloc }
  
```

## 6.36 cpu/or32/dyngen-i386.c File Reference

```
#include <stdio.h>
#include <stdint.h>
#include <stdlib.h>
#include <elf.h>
#include "dyngen.h"
```

Include dependency graph for dyngen-i386.c:

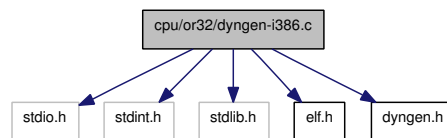

### Defines

- #define [RET\\_OPCODE](#) 0xc3

### Functions

- unsigned int [i386\\_get\\_real\\_func\\_len](#) (void \*f\_start, unsigned int f\_len, char \*name)
- void [i386\\_gen\\_reloc](#) (FILE \*f, struct [reloc](#) \*reloc, unsigned int param)
- void [i386\\_gen\\_func\\_reloc](#) (FILE \*f, struct [reloc](#) \*reloc)

### Variables

- struct [archf](#) archfs

#### 6.36.1 Define Documentation

##### 6.36.1.1 #define RET\_OPCODE 0xc3

#### 6.36.2 Function Documentation

##### 6.36.2.1 void i386\_gen\_func\_reloc (FILE \*f, struct reloc \*reloc)

##### 6.36.2.2 void i386\_gen\_reloc (FILE \*f, struct reloc \*reloc, unsigned int param)

##### 6.36.2.3 unsigned int i386\_get\_real\_func\_len (void \*f\_start, unsigned int f\_len, char \*name)

#### 6.36.3 Variable Documentation

##### 6.36.3.1 struct archf archfs

Initial value:



---

```
{
  i386_get_real_func_len,
  i386_gen_reloc,
  i386_gen_func_reloc
}
```

## 6.37 cpu/or32/dyngen.c File Reference

```
#include <stdio.h>
#include <string.h>
#include <stdlib.h>
#include "dyngen.h"
```

Include dependency graph for dyngen.c:

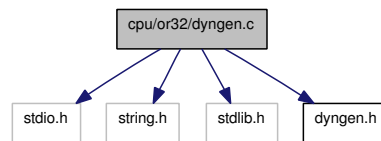

### Defines

- #define `OP_FUNC_PREFIX` "op\_"
- #define `OP_FUNC_PARAM_PREFIX` "\_\_op\_param"
- #define `MAX_PARAMS` (3 + 1)

### Functions

- static void `gen_func_proto` (FILE \*f, const char \*name, int \*params)
- int `main` (int argc, char \*\*argv)

### Variables

- static const char \* `c_file_head`
- static const char \* `gen_code_proto`
- static const char \* `c_sw_file_head`
- static const char \* `c_sw_file_tail`
- static const char \* `c_rel_file_head`
- static const char \* `c_rel_file_tail`

## 6.37.1 Define Documentation

**6.37.1.1** `#define MAX_PARAMS (3 + 1)`

**6.37.1.2** `#define OP_FUNC_PARAM_PREFIX "__op_param"`

**6.37.1.3** `#define OP_FUNC_PREFIX "op_"`

## 6.37.2 Function Documentation

**6.37.2.1** `static void gen_func_proto (FILE *f, const char *name, int *params)` [static]

**6.37.2.2** `int main (int argc, char **argv)`

Here is the call graph for this function:



## 6.37.3 Variable Documentation

**6.37.3.1** `const char* c_file_head` [static]

**Initial value:**

```

#include "config.h"\n"
\n"
#include <inttypes.h>\n"
\n"
#include "arch.h"\n"
#include "opcode/or32.h"\n"
#include "spr-defs.h"\n"
#include "i386-regs.h"\n"
#include "abstract.h"\n"
\n"
#include "dyn-rec.h"\n"
#include "%s"\n"
\n"
  
```

**6.37.3.2** `const char* c_rel_file_head` [static]

**6.37.3.3** `const char* c_rel_file_tail` [static]

**Initial value:**

```

    }\n"
  }\n"
  opq = opq->next;\n"
}\n"
}
  
```

**6.37.3.4** `const char* c_sw_file_head` [static]

**6.37.3.5** `const char* c_sw_file_tail` [static]

**Initial value:**

```
"    }\n"
"  }\n"
"  opq = opq->next;\n"
"  pc += 4;\n"
"  }\n"
"\n"
"  dp->host_len = host_cur - dp->host_page;\n"
"  dp->host_page = realloc(dp->host_page, dp->host_len);\n"
"}\n"
```

**6.37.3.6** `const char* gen_code_proto` [static]

**Initial value:**

```
"void gen_code(struct op_queue *opq, struct dyn_page *dp);\n"
"void patch_relocs(struct op_queue *opq, void *host_page);\n"
"\n"
```

## 6.38 cpu/or32/dyngen.h File Reference

This graph shows which files directly or indirectly include this file:

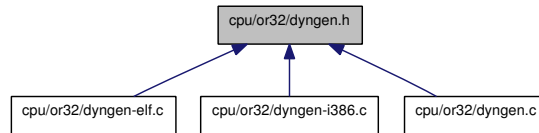

### Data Structures

- struct [reloc](#)
- struct [bff](#)
- struct [archf](#)

### Variables

- struct [bff](#) [bffs](#)
- struct [archf](#) [archfs](#)

### 6.38.1 Variable Documentation

#### 6.38.1.1 struct archf archfs

#### 6.38.1.2 struct bff bffs

## 6.39 cpu/or32/execute.c File Reference

```
#include "config.h"
#include "port.h"
#include <stdlib.h>
#include "execute.h"
#include "toplevel-support.h"
#include "except.h"
#include "labels.h"
#include "gdbcomm.h"
#include "sched.h"
#include "stats.h"
#include "opcode/or32.h"
#include "dmmu.h"
#include "immu.h"
#include "sim-cmd.h"
#include "vapi.h"
#include "debug-unit.h"
#include "branch-predict.h"
#include "support/simprintf.h"
#include "sprs.h"
#include "rsp-server.h"
```

Include dependency graph for execute.c:

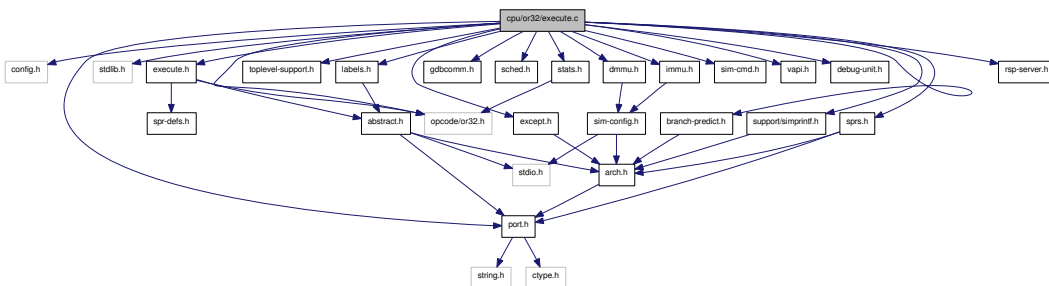

## Functions

- static void [decode\\_execute](#) (struct [iqueue\\_entry](#) \*current)
- [uorreg\\_t evalsim\\_reg](#) (unsigned int regno)
- void [setsim\\_reg](#) (unsigned int regno, [uorreg\\_t](#) value)
- [uorreg\\_t eval\\_operand\\_val](#) (uint32\_t insn, struct insn\_op\_struct \*opd)
- static int [check\\_depend](#) (struct [iqueue\\_entry](#) \*prev, struct [iqueue\\_entry](#) \*next)
- static int [fetch](#) ()

- static void `update_pc` ()
- void `analysis` (struct `iqueue_entry` \**current*)
- static void `sbuf_store` (int cyc)
- static void `sbuf_load` ()
- void `dump_exe_log` ()
- void `dumpreg` ()
- static void `decode_execute_wrapper` (struct `iqueue_entry` \**current*)
- void `cpu_reset` ()
- int `cpu_clock` ()
- void `l_invalid` ()
- void `exec_main` ()

## Variables

- struct `cpu_state` `cpu_state`
- `oraddr_t` `pcnext`
- int `sbuf_wait_cyc` = 0
- int `sbuf_total_cyc` = 0
- int `do_stats` = 0
- struct `hist_exec` \* `hist_exec_tail` = NULL
- static int `multissue` [20]
- static int `issued_per_cycle` = 4
- static int `sbuf_head` = 0
- static int `sbuf_tail` = 0
- static int `sbuf_count` = 0
- static int `sbuf_buf` [MAX\_SBUF\_LEN] = { 0 }
- static int `sbuf_prev_cycles` = 0
- static int `breakpoint`
- static int `next_delay_insn`

### 6.39.1 Function Documentation

#### 6.39.1.1 void `analysis` (struct `iqueue_entry` \* *current*)

Perform analysis of the instruction being executed

This could be static for SIMPLE\_EXECUTION, but made global for general use.

#### Parameters:

← *current* The instruction being executed

Here is the call graph for this function:

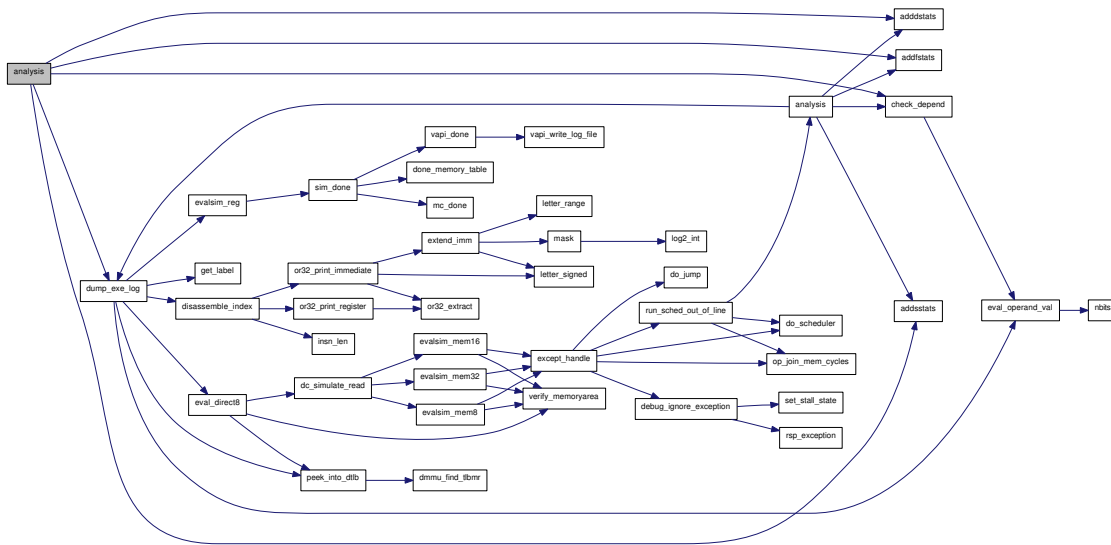

### 6.39.1.2 static int check\_depend (struct iqueue\_entry \* prev, struct iqueue\_entry \* next) [static]

Does source operand depend on computation of dest operand?

Cycle t Cycle t+1 dst: irrelevant src: immediate always 0 dst: reg1 direct src: reg2 direct 0 if reg1 != reg2  
dst: reg1 disp src: reg2 direct always 0 dst: reg1 direct src: reg2 disp 0 if reg1 != reg2 dst: reg1 disp src:  
reg2 disp always 1 (store must finish before load) dst: flag src: flag always 1

#### Parameters:

← *prev* Previous instruction

← *next* Next instruction

#### Returns:

Non-zero if yes.

Here is the call graph for this function:

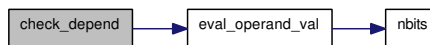

### 6.39.1.3 int cpu\_clock ()

Simulates one CPU clock cycle

#### Returns:

non-zero if a breakpoint is hit, zero otherwise.





Here is the call graph for this function:

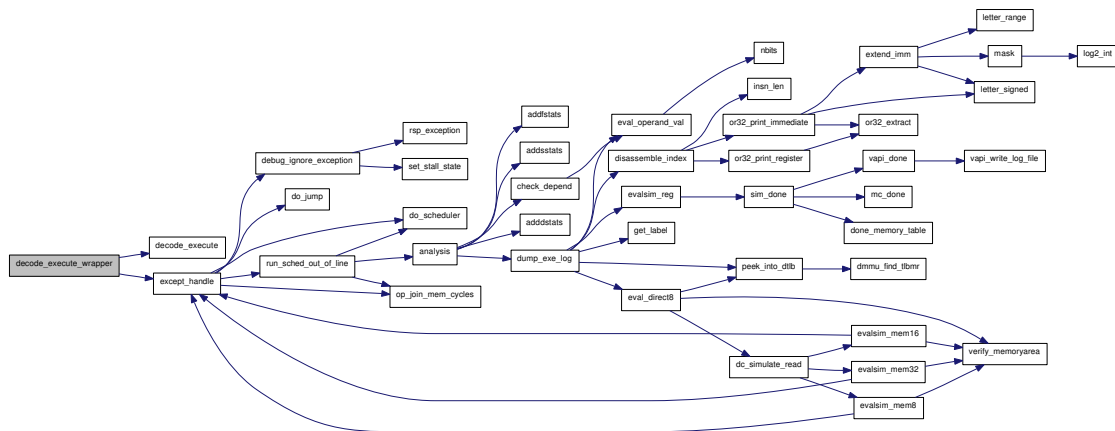

### 6.39.1.7 void dump\_exe\_log ()

Outputs disassembled instruction

Here is the call graph for this function:

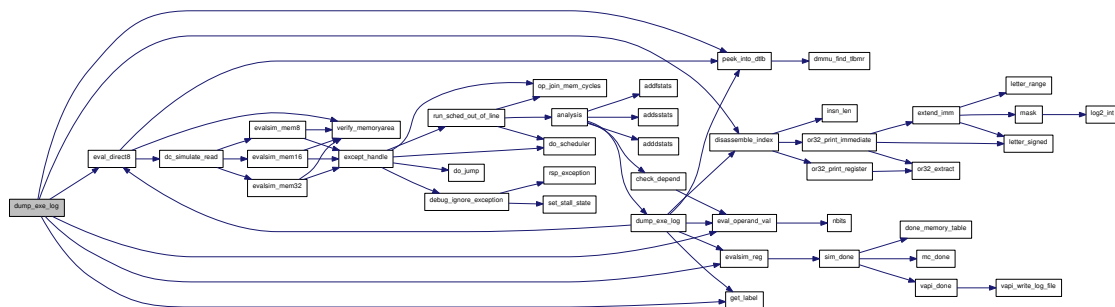

### 6.39.1.8 void dumpreg ()

Dump registers

Supports the CLI 'r' and 't' commands



Here is the call graph for this function:

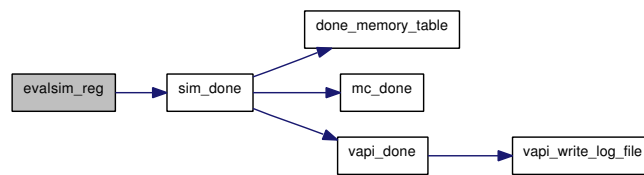

### 6.39.1.11 void exec\_main ()

The main execution loop

Here is the call graph for this function:

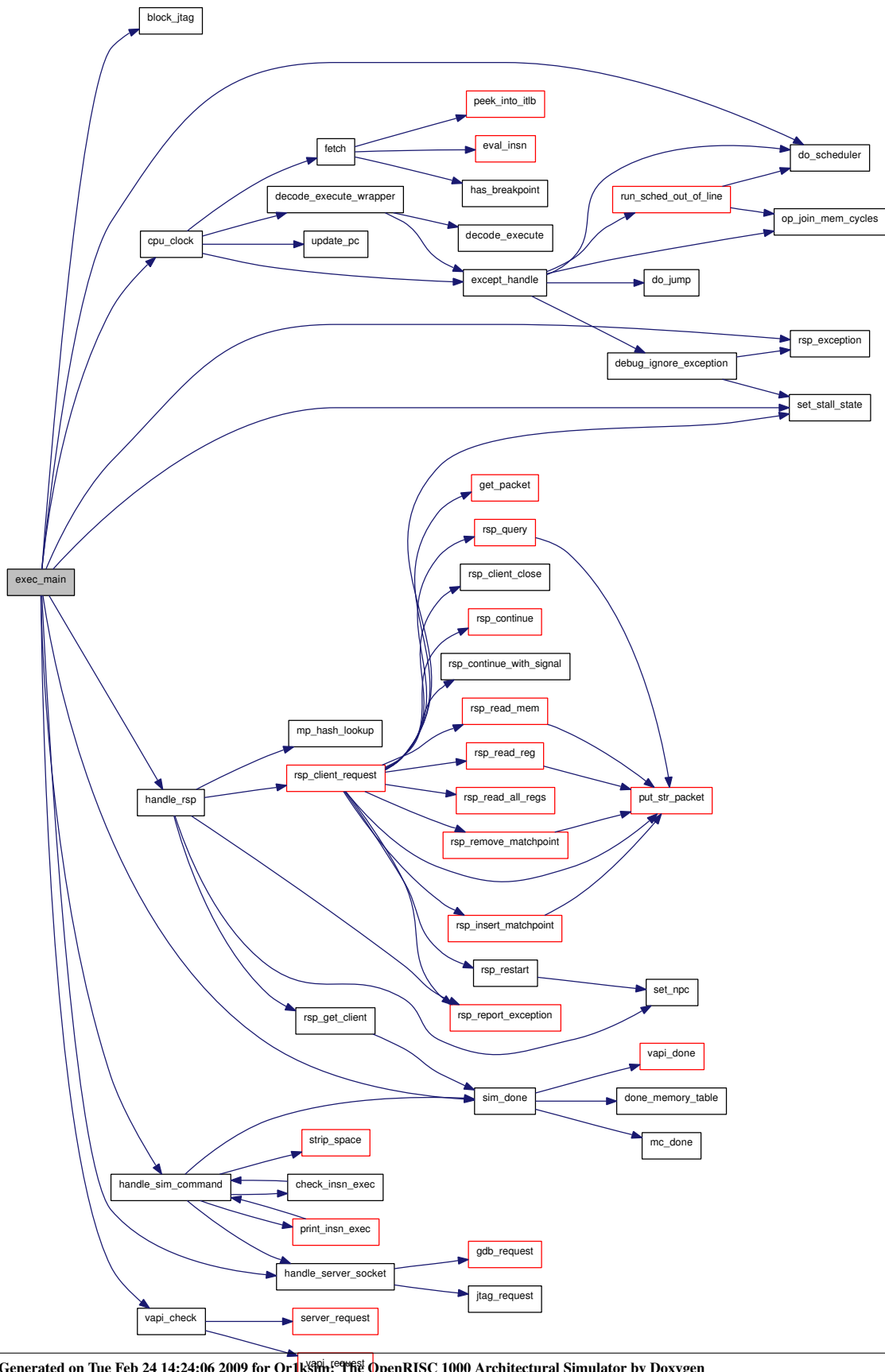

**6.39.1.12 static int fetch () [static]**

Should instruction NOT be executed?

Modified by CZ 26/05/01 for new mode execution.

**Returns:**

Nonzero if instruction should NOT be executed

Here is the call graph for this function:

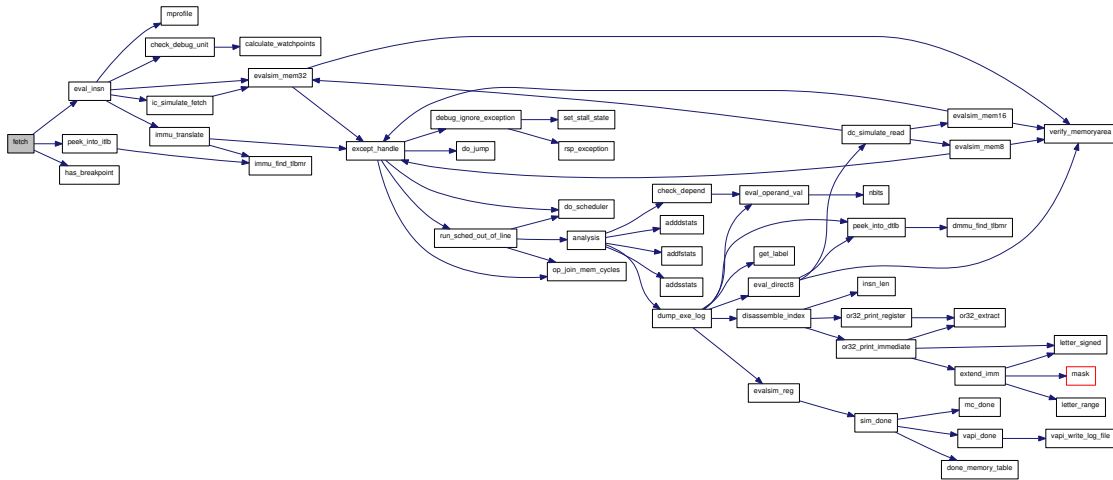

**6.39.1.13 void L\_invalid ()**

If decoding cannot be found, call this function

Here is the call graph for this function:

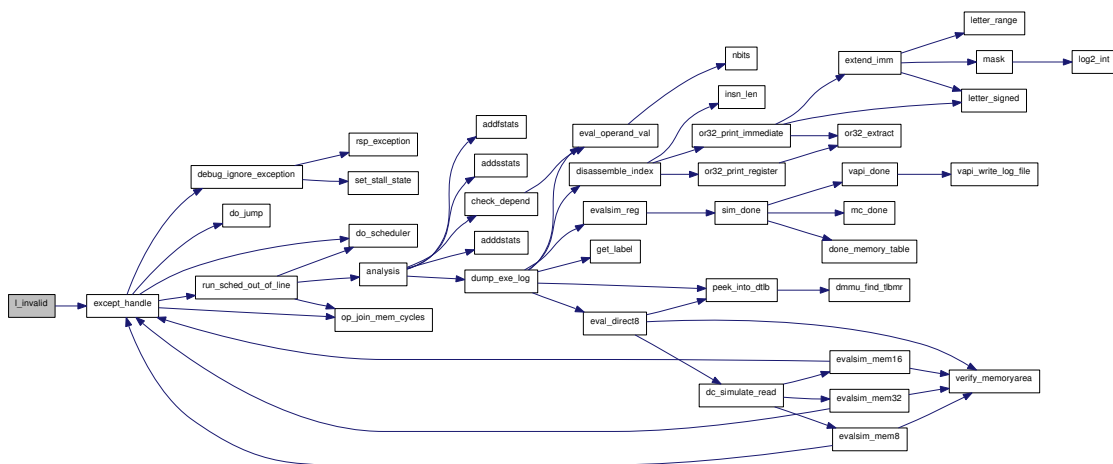

**6.39.1.14 static void sbuf\_load () [static]**

Store buffer analysis for load instructions

Previous stores should commit, before any load

**6.39.1.15 static void sbuf\_store (int cyc) [static]**

Store buffer analysis for store instructions

Stores are accumulated and committed when IO is idle

**Parameters:**

← *cyc* Number of cycles being analysed

**6.39.1.16 void setsim\_reg (unsigned int regno, uorreg\_t value)**

Set a specific register with value

Implementation specific. Abort if we are given a duff register.

**Parameters:**

← *regno* The register of interest

← *value* The value to be set

Here is the call graph for this function:

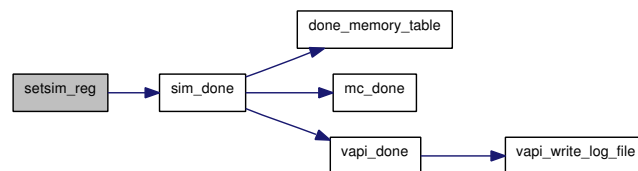
**6.39.1.17 static void update\_pc () [static]**

This code actually updates the PC value

**6.39.2 Variable Documentation****6.39.2.1 int breakpoint [static]****6.39.2.2 struct cpu\_state cpu\_state**

Current cpu state. Globally available.

**6.39.2.3 int do\_stats = 0**

Whether we are doing statistical analysis. Globally available

**6.39.2.4 struct hist\_exec\* hist\_exec\_tail = NULL**

History of execution. Globally available

**6.39.2.5 int issued\_per\_cycle = 4 [static]****6.39.2.6 int multissue[20] [static]****6.39.2.7 int next\_delay\_insn [static]****6.39.2.8 oraddr\_t pcnext**

Temporary program counter. Globally available

**6.39.2.9 int sbuf\_buf[MAX\_SBUF\_LEN] = { 0 } [static]****6.39.2.10 int sbuf\_count = 0 [static]****6.39.2.11 int sbuf\_head = 0 [static]****6.39.2.12 int sbuf\_prev\_cycles = 0 [static]****6.39.2.13 int sbuf\_tail = 0 [static]****6.39.2.14 int sbuf\_total\_cyc = 0**

Number of total store cycles. Globally available

**6.39.2.15 int sbuf\_wait\_cyc = 0**

Num cycles waiting for stores to complete. Globally available



## 6.40 cpu/or32/generate.c File Reference

```
#include "config.h"
#include "port.h"
#include <stdlib.h>
#include <stdio.h>
#include <stdarg.h>
#include "opcode/or32.h"
```

Include dependency graph for generate.c:

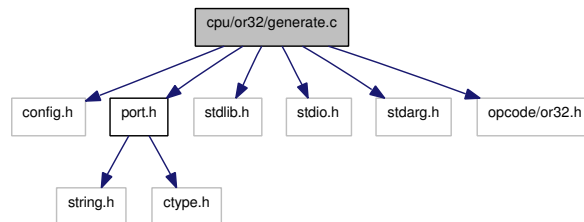

### Functions

- static int [shift\\_fprintf](#) (int level, FILE \*f, const char \*fmt,...)
- int [output\\_function](#) (FILE \*fo, const char \*func\_name, int level)
- static int [gen\\_eval\\_operands](#) (FILE \*fo, int insn\_index, int level)
- static int [output\\_call](#) (FILE \*fo, int index, int level)
- static int [generate\\_header](#) (FILE \*fo)
- static int [generate\\_footer](#) (FILE \*fo)
- static int [generate\\_body](#) (FILE \*fo, unsigned long \*a, unsigned long cur\_mask, int level)
- int [main](#) (int argc, char \*argv[])

### Variables

- static char \* [in\\_file](#)
- static char \* [out\\_file](#)
- static int [write\\_to\\_reg](#)
- static int [out\\_lines](#) = 0

### 6.40.1 Function Documentation

#### 6.40.1.1 static int [gen\\_eval\\_operands](#) (FILE \*fo, int *insn\_index*, int *level*) [static]

Here is the call graph for this function:

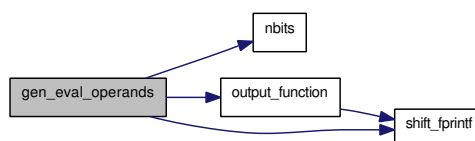

### 6.40.1.2 static int generate\_body (FILE \*fo, unsigned long \*a, unsigned long cur\_mask, int level) [static]

Here is the call graph for this function:

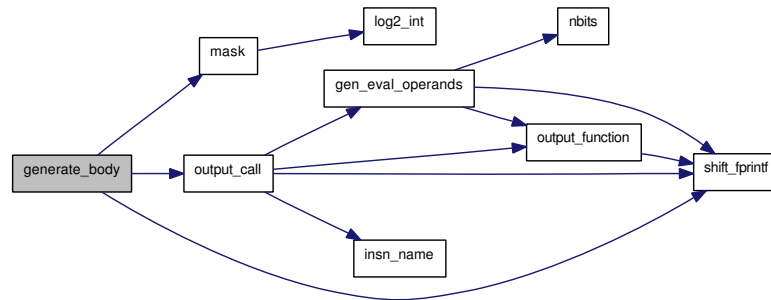

### 6.40.1.3 static int generate\_footer (FILE \*fo) [static]

### 6.40.1.4 static int generate\_header (FILE \*fo) [static]

### 6.40.1.5 int main (int argc, char \*argv[ ])

Here is the call graph for this function:

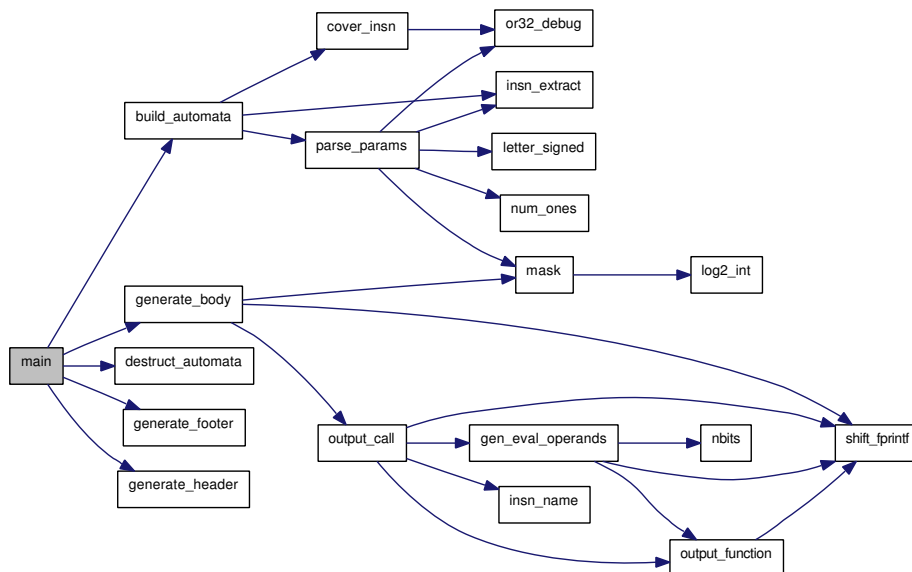

**6.40.1.6** `static int output_call (FILE *fo, int index, int level)` [static]

Here is the call graph for this function:

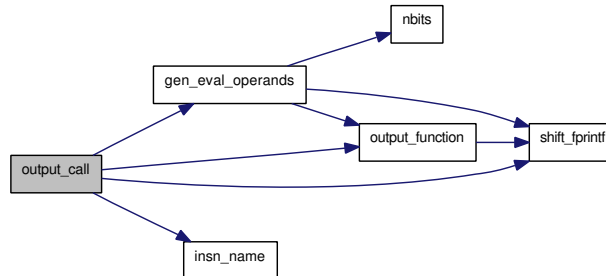
**6.40.1.7** `int output_function (FILE *fo, const char *func_name, int level)`

Here is the call graph for this function:

**6.40.1.8** `static int shift_fprintf (int level, FILE *f, const char *fmt, ...)` [static]**6.40.2** Variable Documentation**6.40.2.1** `char* in_file` [static]**6.40.2.2** `char* out_file` [static]**6.40.2.3** `int out_lines = 0` [static]**6.40.2.4** `int write_to_reg` [static]

## 6.41 cpu/or32/i386-regs.h File Reference

This graph shows which files directly or indirectly include this file:

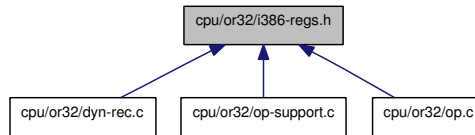

### Defines

- #define `CPU_STATE_REG` "ebp"
- #define `T0_REG` "ebx"
- #define `T1_REG` "esi"
- #define `T2_REG` "edi"
- #define `NUM_T_REGS` 3

#### 6.41.1 Define Documentation

6.41.1.1 #define `CPU_STATE_REG` "ebp"

6.41.1.2 #define `NUM_T_REGS` 3

6.41.1.3 #define `T0_REG` "ebx"

6.41.1.4 #define `T1_REG` "esi"

6.41.1.5 #define `T2_REG` "edi"

## 6.42 cpu/or32/insnset.c File Reference

### Functions

- [INSTRUCTION \(l\\_add\)](#)
- [INSTRUCTION \(l\\_addc\)](#)
- [INSTRUCTION \(l\\_sw\)](#)
- [INSTRUCTION \(l\\_sb\)](#)
- [INSTRUCTION \(l\\_sh\)](#)
- [INSTRUCTION \(l\\_lwz\)](#)
- [INSTRUCTION \(l\\_lbs\)](#)
- [INSTRUCTION \(l\\_lbz\)](#)
- [INSTRUCTION \(l\\_lhs\)](#)
- [INSTRUCTION \(l\\_lhz\)](#)
- [INSTRUCTION \(l\\_movhi\)](#)
- [INSTRUCTION \(l\\_and\)](#)
- [INSTRUCTION \(l\\_or\)](#)
- [INSTRUCTION \(l\\_xor\)](#)
- [INSTRUCTION \(l\\_sub\)](#)
- [INSTRUCTION \(l\\_mul\)](#)
- [INSTRUCTION \(l\\_div\)](#)
- [INSTRUCTION \(l\\_divu\)](#)
- [INSTRUCTION \(l\\_sll\)](#)
- [INSTRUCTION \(l\\_sra\)](#)
- [INSTRUCTION \(l\\_srl\)](#)
- [INSTRUCTION \(l\\_bf\)](#)
- [INSTRUCTION \(l\\_bnf\)](#)
- [INSTRUCTION \(l\\_j\)](#)
- [INSTRUCTION \(l\\_jal\)](#)
- [INSTRUCTION \(l\\_jalr\)](#)
- [INSTRUCTION \(l\\_jr\)](#)
- [INSTRUCTION \(l\\_rfe\)](#)
- [INSTRUCTION \(l\\_nop\)](#)
- [INSTRUCTION \(l\\_sfeq\)](#)
- [INSTRUCTION \(l\\_sfne\)](#)
- [INSTRUCTION \(l\\_sfgts\)](#)
- [INSTRUCTION \(l\\_sfges\)](#)
- [INSTRUCTION \(l\\_sflts\)](#)
- [INSTRUCTION \(l\\_sfles\)](#)
- [INSTRUCTION \(l\\_sfgtu\)](#)
- [INSTRUCTION \(l\\_sfgeu\)](#)
- [INSTRUCTION \(l\\_sfltu\)](#)
- [INSTRUCTION \(l\\_sfleu\)](#)
- [INSTRUCTION \(l\\_extbs\)](#)
- [INSTRUCTION \(l\\_extbz\)](#)
- [INSTRUCTION \(l\\_exths\)](#)
- [INSTRUCTION \(l\\_exthz\)](#)
- [INSTRUCTION \(l\\_extws\)](#)
- [INSTRUCTION \(l\\_extwz\)](#)
- [INSTRUCTION \(l\\_mtspr\)](#)

- [INSTRUCTION](#) (l\_mfspr)
- [INSTRUCTION](#) (l\_sys)
- [INSTRUCTION](#) (l\_trap)
- [INSTRUCTION](#) (l\_mac)
- [INSTRUCTION](#) (l\_msb)
- [INSTRUCTION](#) (l\_macrc)
- [INSTRUCTION](#) (l\_cmov)
- [INSTRUCTION](#) (l\_ff1)
- [INSTRUCTION](#) (lf\_add\_s)
- [INSTRUCTION](#) (lf\_div\_s)
- [INSTRUCTION](#) (lf\_ftoi\_s)
- [INSTRUCTION](#) (lf\_itof\_s)
- [INSTRUCTION](#) (lf\_madd\_s)
- [INSTRUCTION](#) (lf\_mul\_s)
- [INSTRUCTION](#) (lf\_rem\_s)
- [INSTRUCTION](#) (lf\_sfeq\_s)
- [INSTRUCTION](#) (lf\_sfge\_s)
- [INSTRUCTION](#) (lf\_sfgt\_s)
- [INSTRUCTION](#) (lf\_sfle\_s)
- [INSTRUCTION](#) (lf\_sflt\_s)
- [INSTRUCTION](#) (lf\_sfne\_s)
- [INSTRUCTION](#) (lf\_sub\_s)
- [INSTRUCTION](#) (l\_cust1)
- [INSTRUCTION](#) (l\_cust2)
- [INSTRUCTION](#) (l\_cust3)
- [INSTRUCTION](#) (l\_cust4)



## 6.42.1 Function Documentation

6.42.1.1 INSTRUCTION (l\_cust4)

6.42.1.2 INSTRUCTION (l\_cust3)

6.42.1.3 INSTRUCTION (l\_cust2)

6.42.1.4 INSTRUCTION (l\_cust1)

6.42.1.5 INSTRUCTION (lf\_sub\_s)

6.42.1.6 INSTRUCTION (lf\_sfne\_s)

6.42.1.7 INSTRUCTION (lf\_sflt\_s)

6.42.1.8 INSTRUCTION (lf\_sfle\_s)

6.42.1.9 INSTRUCTION (lf\_sfgt\_s)

6.42.1.10 INSTRUCTION (lf\_sfge\_s)

6.42.1.11 INSTRUCTION (lf\_sfeq\_s)

6.42.1.12 INSTRUCTION (lf\_rem\_s)

6.42.1.13 INSTRUCTION (lf\_mul\_s)

6.42.1.14 INSTRUCTION (lf\_madd\_s)

6.42.1.15 INSTRUCTION (lf\_itof\_s)

6.42.1.16 INSTRUCTION (lf\_ftoi\_s)

6.42.1.17 INSTRUCTION (lf\_div\_s)

6.42.1.18 INSTRUCTION (lf\_add\_s)

6.42.1.19 INSTRUCTION (l\_ff1)

6.42.1.20 INSTRUCTION (l\_cmov)

6.42.1.21 INSTRUCTION (l\_macrc)

6.42.1.22 INSTRUCTION (l\_msb)

6.42.1.23 INSTRUCTION (l\_mac)

6.42.1.24 INSTRUCTION (l\_trap)

Here is the call graph for this function:

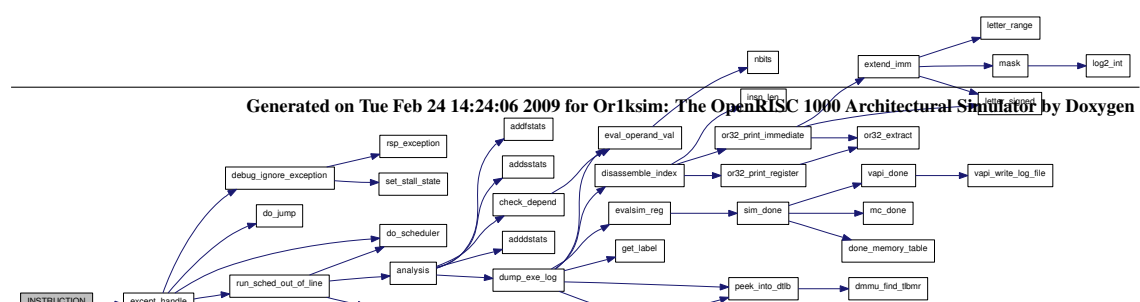





- 6.42.1.28 INSTRUCTION (l\_extwz)
- 6.42.1.29 INSTRUCTION (l\_extws)
- 6.42.1.30 INSTRUCTION (l\_exthz)
- 6.42.1.31 INSTRUCTION (l\_exths)
- 6.42.1.32 INSTRUCTION (l\_extbz)
- 6.42.1.33 INSTRUCTION (l\_extbs)
- 6.42.1.34 INSTRUCTION (l\_sfleu)
- 6.42.1.35 INSTRUCTION (l\_sftu)
- 6.42.1.36 INSTRUCTION (l\_sfgeu)
- 6.42.1.37 INSTRUCTION (l\_sfgtu)
- 6.42.1.38 INSTRUCTION (l\_sfles)
- 6.42.1.39 INSTRUCTION (l\_sfts)
- 6.42.1.40 INSTRUCTION (l\_sfges)
- 6.42.1.41 INSTRUCTION (l\_sfgts)
- 6.42.1.42 INSTRUCTION (l\_sfne)
- 6.42.1.43 INSTRUCTION (l\_sfeq)
- 6.42.1.44 INSTRUCTION (l\_nop)

Here is the call graph for this function:

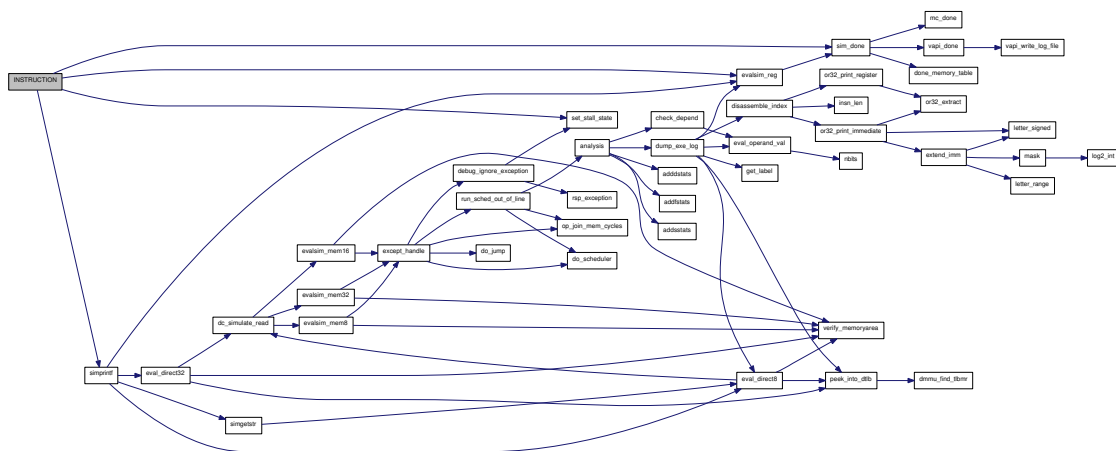

6.42.1.45 INSTRUCTION (l\_rfe)

Here is the call graph for this function:

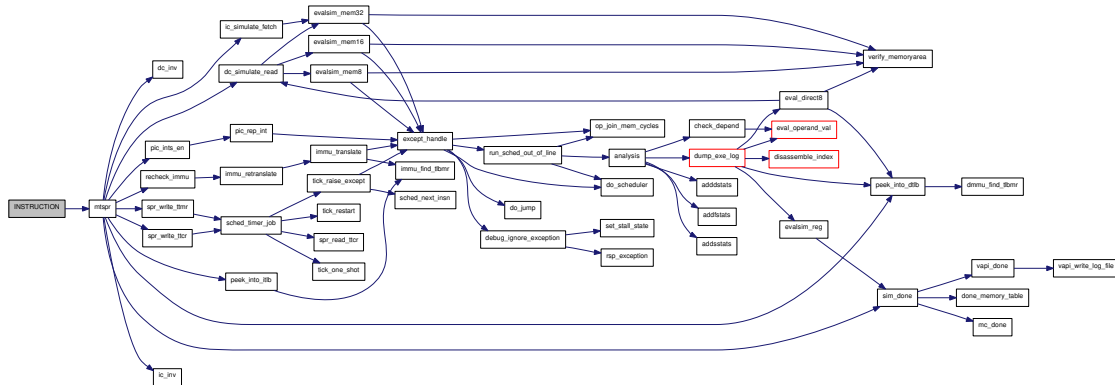

6.42.1.46 INSTRUCTION (l\_jr)

6.42.1.47 INSTRUCTION (l\_jalr)

Here is the call graph for this function:

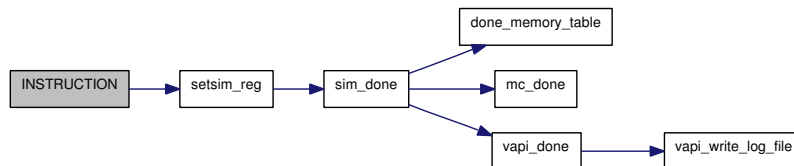

6.42.1.48 INSTRUCTION (l\_jal)

Here is the call graph for this function:

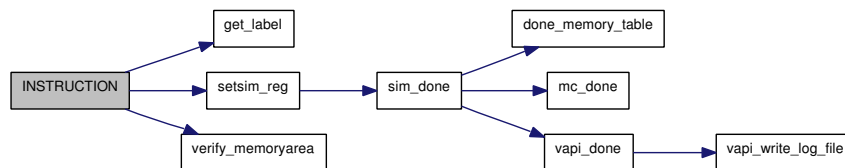

**6.42.1.49 INSTRUCTION (l\_j)****6.42.1.50 INSTRUCTION (l\_bnf)**

Here is the call graph for this function:

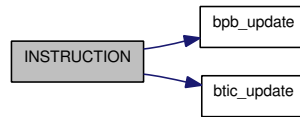
**6.42.1.51 INSTRUCTION (l\_bf)**

Here is the call graph for this function:

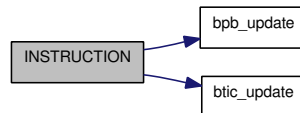
**6.42.1.52 INSTRUCTION (l\_sr1)****6.42.1.53 INSTRUCTION (l\_sra)****6.42.1.54 INSTRUCTION (l\_sl1)****6.42.1.55 INSTRUCTION (l\_divu)**

Here is the call graph for this function:

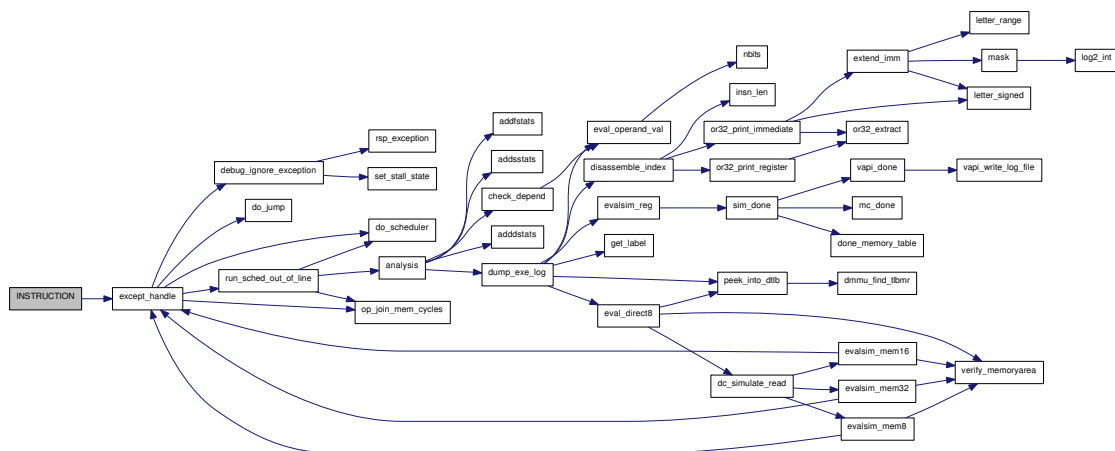

## 6.42.1.56 INSTRUCTION (l\_div)

Here is the call graph for this function:

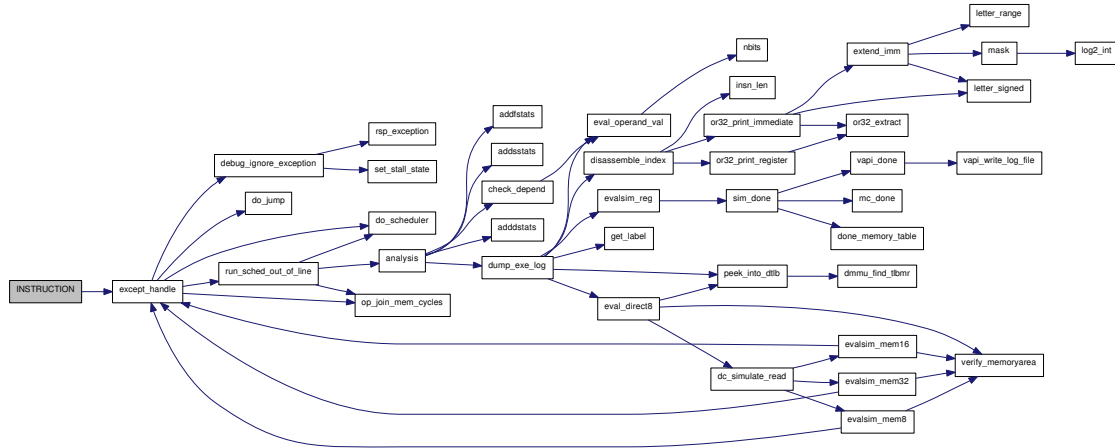

## 6.42.1.57 INSTRUCTION (l\_mul)

## 6.42.1.58 INSTRUCTION (l\_sub)

## 6.42.1.59 INSTRUCTION (l\_xor)

## 6.42.1.60 INSTRUCTION (l\_or)

## 6.42.1.61 INSTRUCTION (l\_and)

## 6.42.1.62 INSTRUCTION (l\_movhi)

## 6.42.1.63 INSTRUCTION (l\_lhz)

Here is the call graph for this function:

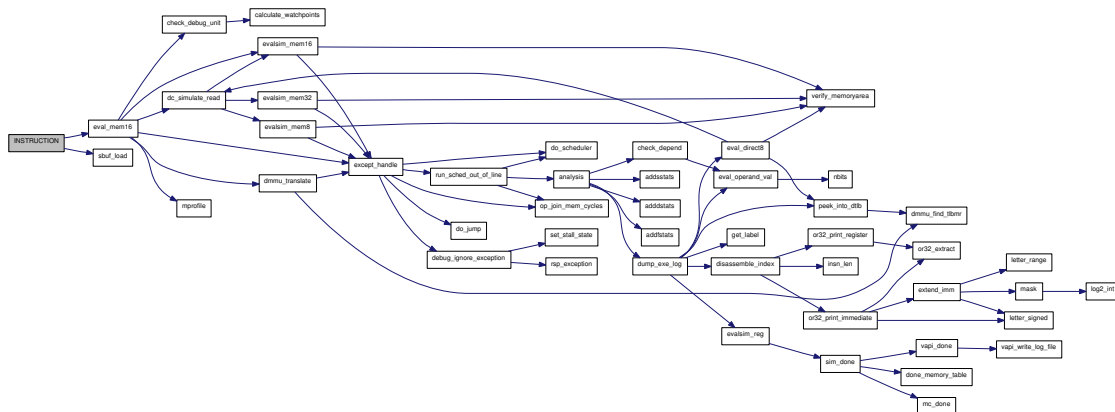

### 6.42.1.64 INSTRUCTION (l\_lhs)

Here is the call graph for this function:

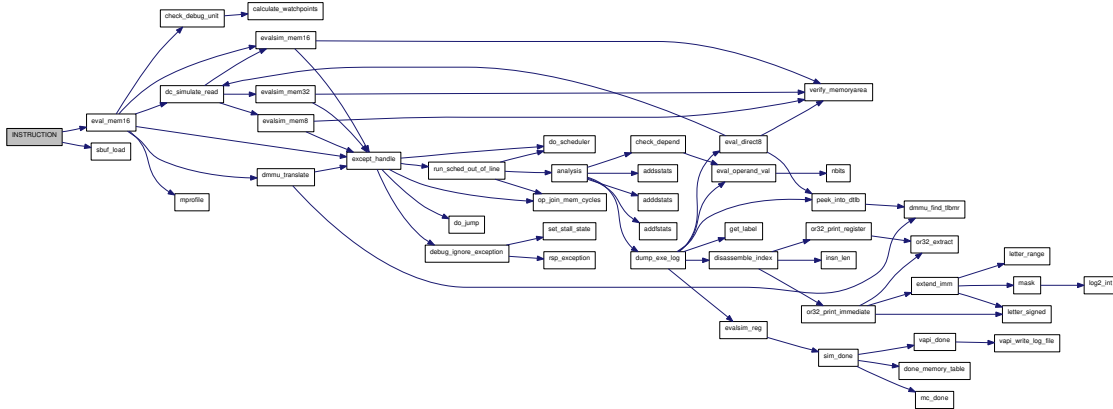

### 6.42.1.65 INSTRUCTION (l\_ibz)

Here is the call graph for this function:

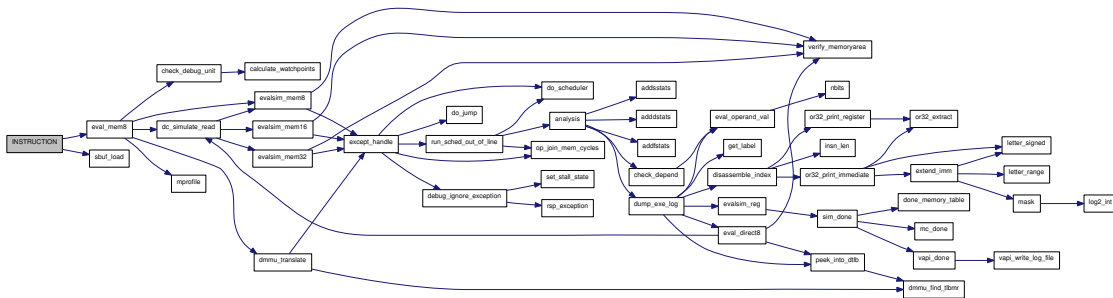

### 6.42.1.66 INSTRUCTION (l\_lbs)

Here is the call graph for this function:

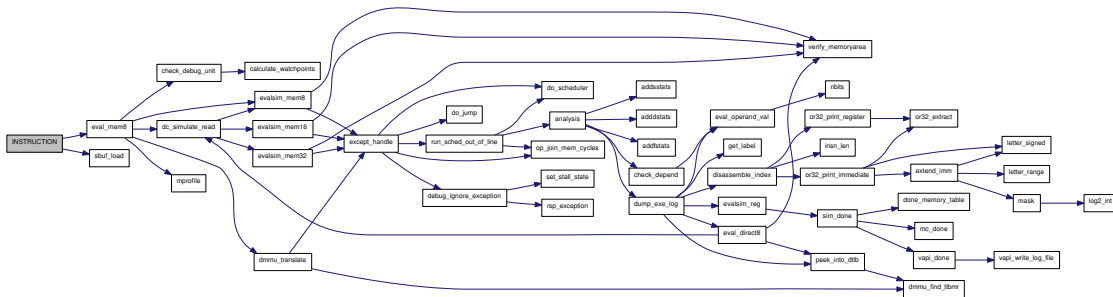



### 6.42.1.69 INSTRUCTION (l\_sb)

Here is the call graph for this function:

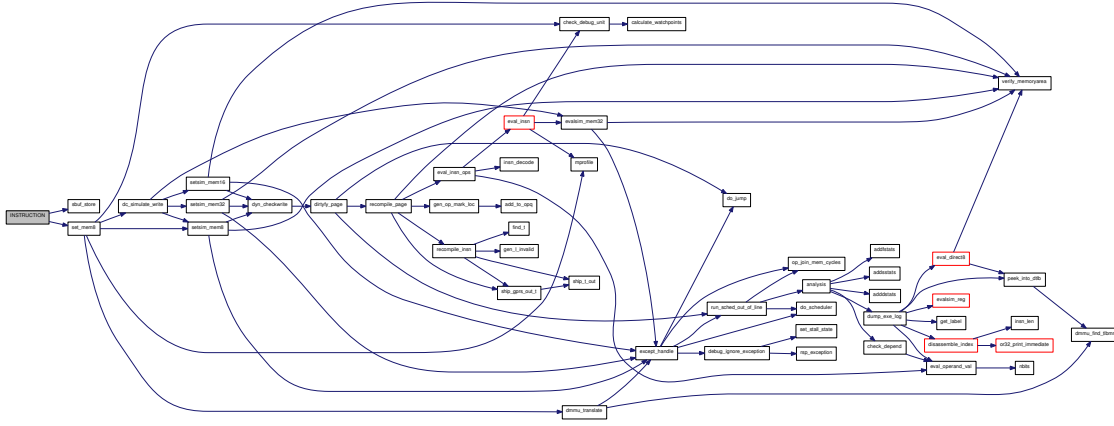

### 6.42.1.70 INSTRUCTION (l\_sw)

Here is the call graph for this function:

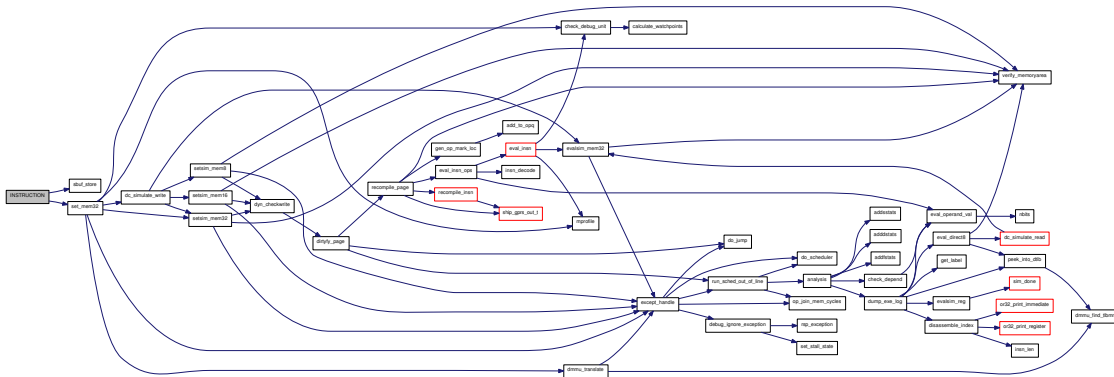

### 6.42.1.71 INSTRUCTION (l\_adde)

### 6.42.1.72 INSTRUCTION (l\_add)



## 6.43 cpu/or32/op-1t-op.h File Reference

### Functions

- `__or_dynop void glue (op_imm, T)(void)`
- `__or_dynop void glue (op_clear, T)(void)`
- `__or_dynop void glue (op_check_null_except_delay, T)(void)`
- `__or_dynop void glue (op_check_null_except, T)(void)`
- `__or_dynop void glue (op_calc_insn_ea, T)(void)`
- `__or_dynop void glue (op_macrc, T)(void)`
- `__or_dynop void glue (op_mac_imm, T)(void)`

### 6.43.1 Function Documentation

**6.43.1.1** `__or_dynop void glue (op_mac_imm, T)`

**6.43.1.2** `__or_dynop void glue (op_macrc, T)`

**6.43.1.3** `__or_dynop void glue (op_calc_insn_ea, T)`

**6.43.1.4** `__or_dynop void glue (op_check_null_except, T)`

Here is the call graph for this function:



**6.43.1.5** `__or_dynop void glue (op_check_null_except_delay, T)`

Here is the call graph for this function:



**6.43.1.6** `__or_dynop void glue (op_clear, T)`

**6.43.1.7** `__or_dynop void glue (op_imm, T)`

## 6.44 cpu/or32/op-1t.h File Reference

This graph shows which files directly or indirectly include this file:

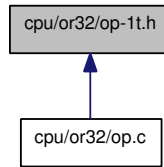

### Defines

- #define [OP\\_1T](#)
- #define [T](#) glue(\_, T0)

### 6.44.1 Define Documentation

#### 6.44.1.1 #define OP\_1T

#### 6.44.1.2 #define T glue(\_, T0)

## 6.45 cpu/or32/op-2t-op.h File Reference

### Functions

- `__or_dynop void glue (op_move, T)(void)`
- `__or_dynop void glue (op_ff1, T)(void)`
- `__or_dynop void glue (op_neg, T)(void)`

#### 6.45.1 Function Documentation

6.45.1.1 `__or_dynop void glue (op_neg, T)`

6.45.1.2 `__or_dynop void glue (op_ff1, T)`

6.45.1.3 `__or_dynop void glue (op_move, T)`

## 6.46 cpu/or32/op-2t.h File Reference

This graph shows which files directly or indirectly include this file:

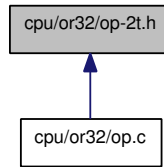

### Defines

- #define [OP\\_2T](#)
- #define [T](#) glue(glue(glue(\_, T0), \_), T1)

### 6.46.1 Define Documentation

#### 6.46.1.1 #define OP\_2T

#### 6.46.1.2 #define T glue(glue(glue(\_, T0), \_), T1)

## 6.47 cpu/or32/op-3t-op.h File Reference

### Functions

- `__or_dynop void glue (op_cmov, T)(void)`

#### 6.47.1 Function Documentation

##### 6.47.1.1 `__or_dynop void glue (op_cmov, T)`

## 6.48 cpu/or32/op-3t.h File Reference

This graph shows which files directly or indirectly include this file:

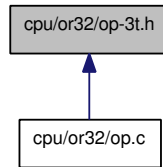

### Defines

- #define [OP\\_3T](#)
- #define [T](#) glue(glue(glue(glue(glue(\_, T0), \_), T1), \_), T2)

### 6.48.1 Define Documentation

#### 6.48.1.1 #define OP\_3T

#### 6.48.1.2 #define T glue(glue(glue(glue(glue(\_, T0), \_), T1), \_), T2)

## 6.49 cpu/or32/op-arith-op.h File Reference

## 6.50 `cpu/or32/op-comp-op.h` File Reference



## 6.51 `cpu/or32/op-extend-op.h` File Reference

### Functions

- void `glue`(`glue(op_, EXT_NAME), T`)(void)

#### 6.51.1 Function Documentation

##### 6.51.1.1 void `glue`(`glue(op_, EXT_NAME), T`)

## 6.52 cpu/or32/op-ff1-op.h File Reference

### Functions

- `__or_dynop void glue(glue(glue(op_ff1_, DST_T), _), SRC_T)(void)`

#### 6.52.1 Function Documentation

##### 6.52.1.1 `__or_dynop void glue(glue(glue(op_ff1_, DST_T), _), SRC_T)`

## 6.53 cpu/or32/op-i386.h File Reference

This graph shows which files directly or indirectly include this file:

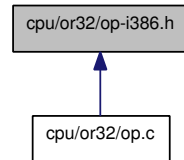

### Defines

- #define [OP\\_JUMP\(x\)](#) `asm("jmp *%0" : : "rm" (x))`
- #define [FORCE\\_RET](#) `asm volatile ("")`
- #define [SPEEDY\\_CALL\(func\)](#) `asm("call "#func"\n")`

### Functions

- `asm (".align 2\n"" .p2align 4,,15\n"" .globl op_do_jump\n"" .type op_do_jump,@function\n""op_do_jump:\n"" ret\n"" ret\n""1:\n"" .size op_do_jump,1b-op_do_jump\n")`

#### 6.53.1 Define Documentation

**6.53.1.1** #define [FORCE\\_RET](#) `asm volatile ("")`

**6.53.1.2** #define [OP\\_JUMP\(x\)](#) `asm("jmp *%0" : : "rm" (x))`

**6.53.1.3** #define [SPEEDY\\_CALL\(func\)](#) `asm("call "#func"\n")`

#### 6.53.2 Function Documentation

**6.53.2.1** `asm (".align 2\n"" .p2align 4, 15\n"" .globl op_do_jump\n"" .type op_do_jump,@function\n""op_do_jump:\n""ret\n""ret\n""1:\n"" .size op_do_jump,1b-op_do_jump\n")`

## 6.54 `cpu/or32/op-lwhb-op.h` File Reference

## 6.55 cpu/or32/op-mac-op.h File Reference

### Functions

- `__or_dynop void glue (glue(op_, OP_NAME), T)(void)`

#### 6.55.1 Function Documentation

##### 6.55.1.1 `__or_dynop void glue (glue(op_, OP_NAME), T)`

## 6.56 cpu/or32/op-mftspr-op.h File Reference

This graph shows which files directly or indirectly include this file:

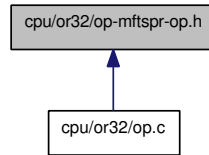

### Functions

- `__or_dynop void op_mtspr_imm_clear (void)`

### 6.56.1 Function Documentation

#### 6.56.1.1 `__or_dynop void op_mtspr_imm_clear (void)`

Here is the call graph for this function:

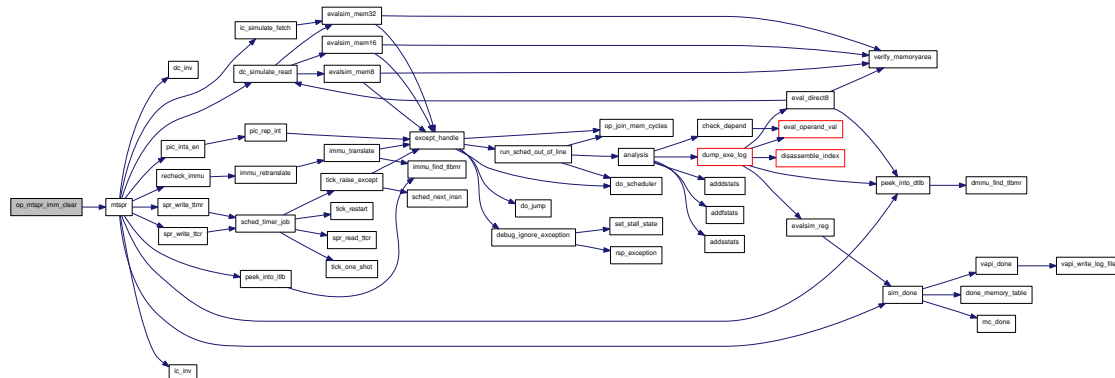

## 6.57 cpu/or32/op-support.c File Reference

```

#include <stdlib.h>
#include "config.h"
#include "port.h"
#include "arch.h"
#include "opcode/or32.h"
#include "sim-config.h"
#include "spr-defs.h"
#include "except.h"
#include "immu.h"
#include "abstract.h"
#include "execute.h"
#include "sched.h"
#include "i386-regs.h"
#include "dyn-rec.h"
#include "op-support.h"
#include "simprintf.h"

```

Include dependency graph for op-support.c:

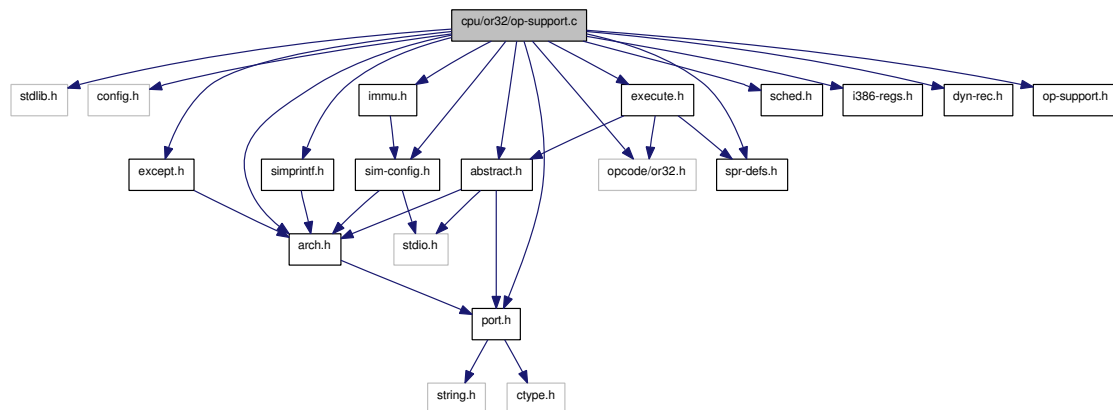

### Functions

- void [op\\_support\\_nop\\_exit](#) (void)
- void [op\\_support\\_nop\\_reset](#) (void)
- void [op\\_support\\_nop\\_printf](#) (void)
- void [op\\_support\\_nop\\_report](#) (void)
- void [op\\_support\\_nop\\_report\\_imm](#) (int imm)
- void [do\\_jump](#) (oraddr\_t addr)
- void [op\\_support\\_analysis](#) (void)

## 6.57.1 Function Documentation

### 6.57.1.1 void do\_jump (oraddr\_t addr)

### 6.57.1.2 void op\_support\_analysis (void)

Here is the call graph for this function:

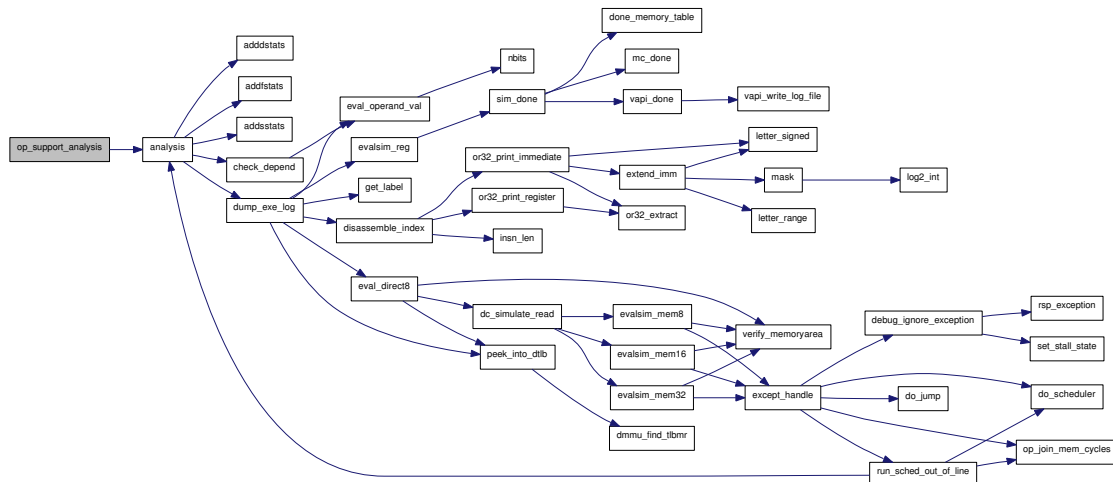

### 6.57.1.3 void op\_support\_nop\_exit (void)

### 6.57.1.4 void op\_support\_nop\_printf (void)

Here is the call graph for this function:

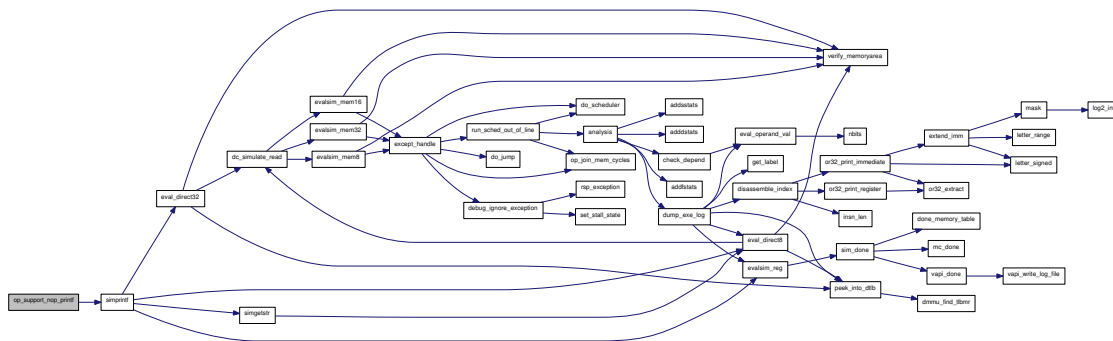

### 6.57.1.5 void op\_support\_nop\_report (void)

### 6.57.1.6 void op\_support\_nop\_report\_imm (int imm)

### 6.57.1.7 void op\_support\_nop\_reset (void)



## 6.58 cpu/or32/op-support.h File Reference

This graph shows which files directly or indirectly include this file:

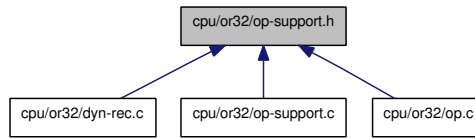

### Functions

- void [op\\_support\\_nop\\_exit](#) (void)
- void [op\\_support\\_nop\\_reset](#) (void)
- void [op\\_support\\_nop\\_printf](#) (void)
- void [op\\_support\\_nop\\_report](#) (void)
- void [op\\_support\\_nop\\_report\\_imm](#) (int imm)
- void [op\\_support\\_analysis](#) (void)
- void [do\\_jump](#) (oraddr\_t addr)
- void [upd\\_reg\\_from\\_t](#) (oraddr\_t pc, int bound)

### 6.58.1 Function Documentation

#### 6.58.1.1 void do\_jump (oraddr\_t addr)

#### 6.58.1.2 void op\_support\_analysis (void)

Here is the call graph for this function:

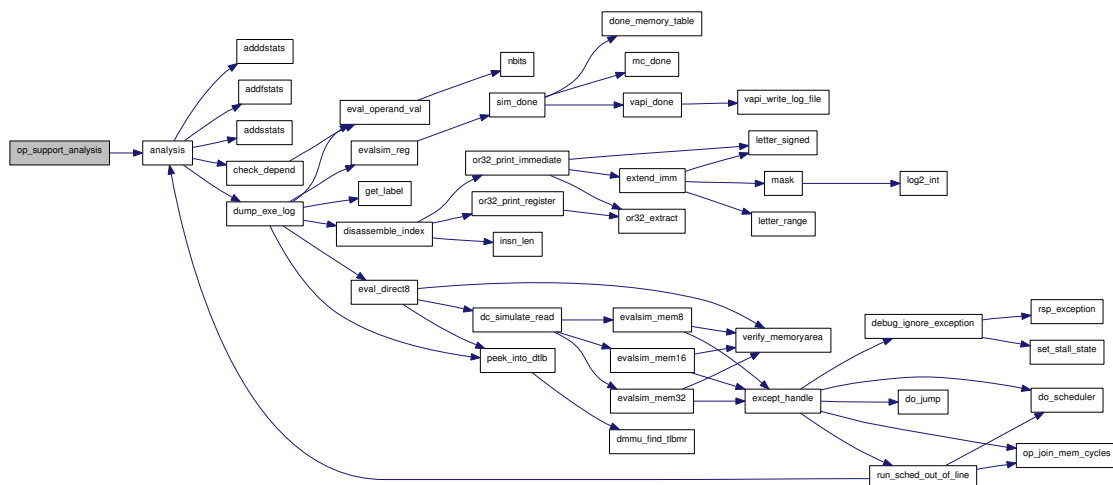



## 6.59 cpu/or32/op-swhb-op.h File Reference

This graph shows which files directly or indirectly include this file:

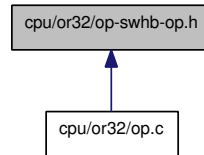

### Functions

- `__or_dynop void glue (glue(op_, S_OP_NAME), _clear_imm)(void)`

#### 6.59.1 Function Documentation

##### 6.59.1.1 `__or_dynop void glue (glue(op_, S_OP_NAME), _clear_imm)`

## 6.60 cpu/or32/op-t-reg-mov-op.h File Reference

### Functions

- `__or_dynop void glue (op_gtt_gpr1, T)(void)`
- `__or_dynop void glue (op_gtt_gpr2, T)(void)`
- `__or_dynop void glue (op_gtt_gpr3, T)(void)`
- `__or_dynop void glue (op_gtt_gpr4, T)(void)`
- `__or_dynop void glue (op_gtt_gpr5, T)(void)`
- `__or_dynop void glue (op_gtt_gpr6, T)(void)`
- `__or_dynop void glue (op_gtt_gpr7, T)(void)`
- `__or_dynop void glue (op_gtt_gpr8, T)(void)`
- `__or_dynop void glue (op_gtt_gpr9, T)(void)`
- `__or_dynop void glue (op_gtt_gpr10, T)(void)`
- `__or_dynop void glue (op_gtt_gpr11, T)(void)`
- `__or_dynop void glue (op_gtt_gpr12, T)(void)`
- `__or_dynop void glue (op_gtt_gpr13, T)(void)`
- `__or_dynop void glue (op_gtt_gpr14, T)(void)`
- `__or_dynop void glue (op_gtt_gpr15, T)(void)`
- `__or_dynop void glue (op_gtt_gpr16, T)(void)`
- `__or_dynop void glue (op_gtt_gpr17, T)(void)`
- `__or_dynop void glue (op_gtt_gpr18, T)(void)`
- `__or_dynop void glue (op_gtt_gpr19, T)(void)`
- `__or_dynop void glue (op_gtt_gpr20, T)(void)`
- `__or_dynop void glue (op_gtt_gpr21, T)(void)`
- `__or_dynop void glue (op_gtt_gpr22, T)(void)`
- `__or_dynop void glue (op_gtt_gpr23, T)(void)`
- `__or_dynop void glue (op_gtt_gpr24, T)(void)`
- `__or_dynop void glue (op_gtt_gpr25, T)(void)`
- `__or_dynop void glue (op_gtt_gpr26, T)(void)`
- `__or_dynop void glue (op_gtt_gpr27, T)(void)`
- `__or_dynop void glue (op_gtt_gpr28, T)(void)`
- `__or_dynop void glue (op_gtt_gpr29, T)(void)`
- `__or_dynop void glue (op_gtt_gpr30, T)(void)`
- `__or_dynop void glue (op_gtt_gpr31, T)(void)`
- `__or_dynop void glue (op_ttg_gpr1, T)(void)`
- `__or_dynop void glue (op_ttg_gpr2, T)(void)`
- `__or_dynop void glue (op_ttg_gpr3, T)(void)`
- `__or_dynop void glue (op_ttg_gpr4, T)(void)`
- `__or_dynop void glue (op_ttg_gpr5, T)(void)`
- `__or_dynop void glue (op_ttg_gpr6, T)(void)`
- `__or_dynop void glue (op_ttg_gpr7, T)(void)`
- `__or_dynop void glue (op_ttg_gpr8, T)(void)`
- `__or_dynop void glue (op_ttg_gpr9, T)(void)`
- `__or_dynop void glue (op_ttg_gpr10, T)(void)`
- `__or_dynop void glue (op_ttg_gpr11, T)(void)`
- `__or_dynop void glue (op_ttg_gpr12, T)(void)`
- `__or_dynop void glue (op_ttg_gpr13, T)(void)`
- `__or_dynop void glue (op_ttg_gpr14, T)(void)`
- `__or_dynop void glue (op_ttg_gpr15, T)(void)`

- `__or_dynop void glue (op_ttg_gpr16, T)(void)`
- `__or_dynop void glue (op_ttg_gpr17, T)(void)`
- `__or_dynop void glue (op_ttg_gpr18, T)(void)`
- `__or_dynop void glue (op_ttg_gpr19, T)(void)`
- `__or_dynop void glue (op_ttg_gpr20, T)(void)`
- `__or_dynop void glue (op_ttg_gpr21, T)(void)`
- `__or_dynop void glue (op_ttg_gpr22, T)(void)`
- `__or_dynop void glue (op_ttg_gpr23, T)(void)`
- `__or_dynop void glue (op_ttg_gpr24, T)(void)`
- `__or_dynop void glue (op_ttg_gpr25, T)(void)`
- `__or_dynop void glue (op_ttg_gpr26, T)(void)`
- `__or_dynop void glue (op_ttg_gpr27, T)(void)`
- `__or_dynop void glue (op_ttg_gpr28, T)(void)`
- `__or_dynop void glue (op_ttg_gpr29, T)(void)`
- `__or_dynop void glue (op_ttg_gpr30, T)(void)`
- `__or_dynop void glue (op_ttg_gpr31, T)(void)`



## 6.60.1 Function Documentation

6.60.1.1 `__or_dynop void glue (op_ttg_gpr31, T)`

6.60.1.2 `__or_dynop void glue (op_ttg_gpr30, T)`

6.60.1.3 `__or_dynop void glue (op_ttg_gpr29, T)`

6.60.1.4 `__or_dynop void glue (op_ttg_gpr28, T)`

6.60.1.5 `__or_dynop void glue (op_ttg_gpr27, T)`

6.60.1.6 `__or_dynop void glue (op_ttg_gpr26, T)`

6.60.1.7 `__or_dynop void glue (op_ttg_gpr25, T)`

6.60.1.8 `__or_dynop void glue (op_ttg_gpr24, T)`

6.60.1.9 `__or_dynop void glue (op_ttg_gpr23, T)`

6.60.1.10 `__or_dynop void glue (op_ttg_gpr22, T)`

6.60.1.11 `__or_dynop void glue (op_ttg_gpr21, T)`

6.60.1.12 `__or_dynop void glue (op_ttg_gpr20, T)`

6.60.1.13 `__or_dynop void glue (op_ttg_gpr19, T)`

6.60.1.14 `__or_dynop void glue (op_ttg_gpr18, T)`

6.60.1.15 `__or_dynop void glue (op_ttg_gpr17, T)`

6.60.1.16 `__or_dynop void glue (op_ttg_gpr16, T)`

6.60.1.17 `__or_dynop void glue (op_ttg_gpr15, T)`

6.60.1.18 `__or_dynop void glue (op_ttg_gpr14, T)`

6.60.1.19 `__or_dynop void glue (op_ttg_gpr13, T)`

6.60.1.20 `__or_dynop void glue (op_ttg_gpr12, T)`

6.60.1.21 `__or_dynop void glue (op_ttg_gpr11, T)`

6.60.1.22 `__or_dynop void glue (op_ttg_gpr10, T)`

6.60.1.23 `__or_dynop void glue (op_ttg_gpr9, T)`

6.60.1.24 `__or_dynop void glue (op_ttg_gpr8, T)`

6.60.1.25 `__or_dynop void glue (op_ttg_gpr7, T)`

6.60.1.26 `__or_dynop void glue (op_ttg_gpr6, T)`

6.60.1.27 `__or_dynop void glue (op_ttg_gpr5, T)`

6.60.1.28 `__or_dynop void glue (op_ttg_gpr4, T)`

6.60.1.29 `__or_dynop void glue (op_ttg_gpr3, T)`

6.60.1.30 `__or_dynop void glue (op_ttg_gpr2, T)`

## 6.61 cpu/or32/op.c File Reference

```

#include <stdio.h>
#include <stdint.h>
#include <stdlib.h>
#include "config.h"
#include "port.h"
#include "arch.h"
#include "spr-defs.h"
#include "opcode/or32.h"
#include "sim-config.h"
#include "except.h"
#include "abstract.h"
#include "execute.h"
#include "sprs.h"
#include "sched.h"
#include "immu.h"
#include "op-support.h"
#include "i386-regs.h"
#include "dyn-rec.h"
#include "op-i386.h"
#include "op-1t.h"
#include "op-2t.h"
#include "op-3t.h"
#include "op-mftspr-op.h"
#include "op-swhb-op.h"

```

Include dependency graph for op.c:

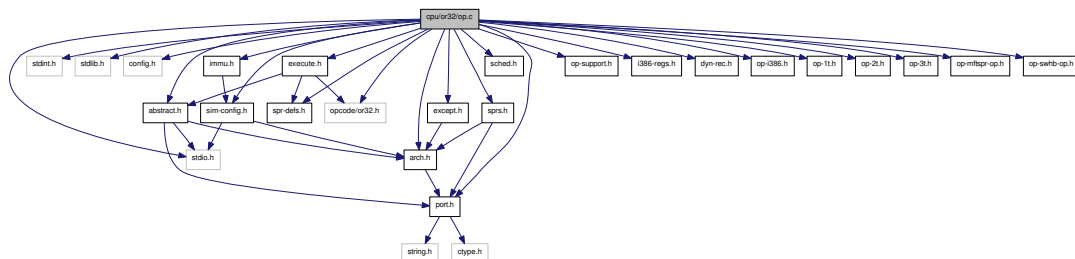

### Defines

- #define `__or_dynop`



- #define OP\_PARAM1 ((uorreg\_t)(&\_\_op\_param1))
- #define OP\_PARAM2 ((uorreg\_t)(&\_\_op\_param2))
- #define OP\_PARAM3 ((uorreg\_t)(&\_\_op\_param3))
- #define OP\_FILE "op-1t-op.h"
- #define OP\_FILE "op-2t-op.h"
- #define OP\_FILE "op-3t-op.h"
- #define OP\_FILE "op-arith-op.h"
- #define OP\_EXTRA
- #define OP /
- #define OP\_CAST(x) (orreg\_t)(x)
- #define OP\_NAME div
- #define OP /
- #define OP\_CAST(x) (x)
- #define OP\_NAME divu
- #define OP \*
- #define OP\_CAST(x) (x)
- #define OP\_NAME mulu
- #define OP -
- #define OP\_CAST(x) (orreg\_t)(x)
- #define OP\_NAME sub
- #define OP\_EXTRA + ((env → sprs[SPR\_SR] & SPR\_SR\_CY) >> 10)
- #define OP +
- #define OP\_CAST(x) (orreg\_t)(x)
- #define OP\_NAME addc
- #define OP\_EXTRA
- #define OP +
- #define OP\_CAST(x) (orreg\_t)(x)
- #define OP\_NAME add
- #define OP &
- #define OP\_CAST(x) (x)
- #define OP\_NAME and
- #define OP \*
- #define OP\_CAST(x) (orreg\_t)(x)
- #define OP\_NAME mul
- #define OP |
- #define OP\_CAST(x) (x)
- #define OP\_NAME or
- #define OP <<
- #define OP\_CAST(x) (x)
- #define OP\_NAME sll
- #define OP >>
- #define OP\_CAST(x) (orreg\_t)(x)
- #define OP\_NAME sra
- #define OP >>
- #define OP\_CAST(x) (x)
- #define OP\_NAME srl
- #define OP ^
- #define OP\_CAST(x) (x)
- #define OP\_NAME xor
- #define OP\_FILE "op-extend-op.h"

- #define EXT\_NAME extbs
- #define EXT\_TYPE int8\_t
- #define EXT\_CAST (orreg\_t)
- #define EXT\_NAME extbz
- #define EXT\_TYPE uint8\_t
- #define EXT\_CAST (uorreg\_t)
- #define EXT\_NAME exths
- #define EXT\_TYPE int16\_t
- #define EXT\_CAST (orreg\_t)
- #define EXT\_NAME exthz
- #define EXT\_TYPE uint16\_t
- #define EXT\_CAST (uorreg\_t)
- #define OP\_FILE "op-comp-op.h"
- #define COMP ==
- #define COMP\_NAME sfeq
- #define COMP\_CAST(x) (x)
- #define COMP !=
- #define COMP\_NAME sfne
- #define COMP\_CAST(x) (x)
- #define COMP >
- #define COMP\_NAME sfgtu
- #define COMP\_CAST(x) (x)
- #define COMP >=
- #define COMP\_NAME sfgeu
- #define COMP\_CAST(x) (x)
- #define COMP <
- #define COMP\_NAME sfltu
- #define COMP\_CAST(x) (x)
- #define COMP <=
- #define COMP\_NAME sfleu
- #define COMP\_CAST(x) (x)
- #define COMP >
- #define COMP\_NAME sfgts
- #define COMP\_CAST(x) (orreg\_t)(x)
- #define COMP >=
- #define COMP\_NAME sfges
- #define COMP\_CAST(x) (orreg\_t)(x)
- #define COMP <
- #define COMP\_NAME sflts
- #define COMP\_CAST(x) (orreg\_t)(x)
- #define COMP <=
- #define COMP\_NAME sfles
- #define COMP\_CAST(x) (orreg\_t)(x)
- #define OP\_FILE "op-t-reg-mov-op.h"
- #define OP\_FILE "op-mftspr-op.h"
- #define OP\_FILE "op-mac-op.h"
- #define OP +=
- #define OP\_NAME mac
- #define OP -=
- #define OP\_NAME msb

- #define `OP_FILE` "op-lwhb-op.h"
- #define `LS_OP_NAME` lbz
- #define `LS_OP_CAST`
- #define `LS_OP_FUNC` eval\_mem8
- #define `LS_OP_NAME` lbs
- #define `LS_OP_CAST` (int8\_t)
- #define `LS_OP_FUNC` eval\_mem8
- #define `LS_OP_NAME` lhz
- #define `LS_OP_CAST`
- #define `LS_OP_FUNC` eval\_mem16
- #define `LS_OP_NAME` lhs
- #define `LS_OP_CAST` (int16\_t)
- #define `LS_OP_FUNC` eval\_mem16
- #define `LS_OP_NAME` lwz
- #define `LS_OP_CAST`
- #define `LS_OP_FUNC` eval\_mem32
- #define `LS_OP_NAME` lws
- #define `LS_OP_CAST` (int32\_t)
- #define `LS_OP_FUNC` eval\_mem32
- #define `OP_FILE` "op-swhb-op.h"
- #define `S_OP_NAME` sb
- #define `S_FUNC` set\_mem8
- #define `S_OP_NAME` sh
- #define `S_FUNC` set\_mem16
- #define `S_OP_NAME` sw
- #define `S_FUNC` set\_mem32

## Functions

- register struct `cpu_state` \*env `asm` (CPU\_STATE\_REG)
- register uint32\_t t0 `asm` (T0\_REG)
- register uint32\_t t1 `asm` (T1\_REG)
- register uint32\_t t2 `asm` (T2\_REG)
- static void `save_t_bound` (oraddr\_t pc)
- void `do_sched_wrap` (void)
- void `do_sched_wrap_delay` (void)
- void `enter_dyn_code` (oraddr\_t addr, struct `dyn_page` \*dp)
- \_\_or\_dynop void `op_set_pc_pc_delay` (void)
- \_\_or\_dynop void `op_set_pc_delay_imm` (void)
- \_\_or\_dynop void `op_set_pc_delay_pc` (void)
- \_\_or\_dynop void `op_clear_pc_delay` (void)
- \_\_or\_dynop void `op_do_jump_delay` (void)
- \_\_or\_dynop void `op_clear_delay_insn` (void)
- \_\_or\_dynop void `op_set_delay_insn` (void)
- \_\_or\_dynop void `op_check_delay_slot` (void)
- \_\_or\_dynop void `op_jump_imm` (void)
- \_\_or\_dynop void `op_set_flag` (void)
- \_\_or\_dynop void `op_clear_flag` (void)
- \_\_or\_dynop void `op_check_flag` (void)
- \_\_or\_dynop void `op_check_flag_delay` (void)

- `__or_dynop` void `op_check_not_flag` (void)
- `__or_dynop` void `op_check_not_flag_delay` (void)
- `__or_dynop` void `op_add_pc` (void)
- `__or_dynop` void `op_nop_exit` (void)
- `__or_dynop` void `op_nop_reset` (void)
- `__or_dynop` void `op_nop_printf` (void)
- `__or_dynop` void `op_nop_report` (void)
- `__or_dynop` void `op_nop_report_imm` (void)
- `__or_dynop` void `op_analysis` (void)
- `__or_dynop` void `op_move_gpr1_pc_delay` (void)
- `__or_dynop` void `op_move_gpr2_pc_delay` (void)
- `__or_dynop` void `op_move_gpr3_pc_delay` (void)
- `__or_dynop` void `op_move_gpr4_pc_delay` (void)
- `__or_dynop` void `op_move_gpr5_pc_delay` (void)
- `__or_dynop` void `op_move_gpr6_pc_delay` (void)
- `__or_dynop` void `op_move_gpr7_pc_delay` (void)
- `__or_dynop` void `op_move_gpr8_pc_delay` (void)
- `__or_dynop` void `op_move_gpr9_pc_delay` (void)
- `__or_dynop` void `op_move_gpr10_pc_delay` (void)
- `__or_dynop` void `op_move_gpr11_pc_delay` (void)
- `__or_dynop` void `op_move_gpr12_pc_delay` (void)
- `__or_dynop` void `op_move_gpr13_pc_delay` (void)
- `__or_dynop` void `op_move_gpr14_pc_delay` (void)
- `__or_dynop` void `op_move_gpr15_pc_delay` (void)
- `__or_dynop` void `op_move_gpr16_pc_delay` (void)
- `__or_dynop` void `op_move_gpr17_pc_delay` (void)
- `__or_dynop` void `op_move_gpr18_pc_delay` (void)
- `__or_dynop` void `op_move_gpr19_pc_delay` (void)
- `__or_dynop` void `op_move_gpr20_pc_delay` (void)
- `__or_dynop` void `op_move_gpr21_pc_delay` (void)
- `__or_dynop` void `op_move_gpr22_pc_delay` (void)
- `__or_dynop` void `op_move_gpr23_pc_delay` (void)
- `__or_dynop` void `op_move_gpr24_pc_delay` (void)
- `__or_dynop` void `op_move_gpr25_pc_delay` (void)
- `__or_dynop` void `op_move_gpr26_pc_delay` (void)
- `__or_dynop` void `op_move_gpr27_pc_delay` (void)
- `__or_dynop` void `op_move_gpr28_pc_delay` (void)
- `__or_dynop` void `op_move_gpr29_pc_delay` (void)
- `__or_dynop` void `op_move_gpr30_pc_delay` (void)
- `__or_dynop` void `op_move_gpr31_pc_delay` (void)
- `__or_dynop` void `op_join_mem_cycles` (void)
- `__or_dynop` void `op_store_link_addr_gpr` (void)
- `__or_dynop` void `op_prep_rfe` (void)
- static void `prep_except` (oraddr\_t epcr\_base)
- `__or_dynop` void `op_prep_sys_delay` (void)
- `__or_dynop` void `op_prep_sys` (void)
- `__or_dynop` void `op_prep_trap_delay` (void)
- `__or_dynop` void `op_prep_trap` (void)
- `__or_dynop` void `op_illegal_delay` (void)
- `__or_dynop` void `op_illegal` (void)

- `__or_dynop` void [op\\_do\\_sched](#) (void)
- `__or_dynop` void [op\\_do\\_sched\\_delay](#) (void)
- `__or_dynop` void [op\\_macc](#) (void)
- `__or_dynop` void [op\\_store\\_insn\\_ea](#) (void)

## Variables

- `uorreg_t` [\\_\\_op\\_param1](#)
- `uorreg_t` [\\_\\_op\\_param2](#)
- `uorreg_t` [\\_\\_op\\_param3](#)



## 6.61.1 Define Documentation

6.61.1.1 `#define __or_dynop`

6.61.1.2 `#define COMP <=`

6.61.1.3 `#define COMP <`

6.61.1.4 `#define COMP >=`

6.61.1.5 `#define COMP >`

6.61.1.6 `#define COMP <=`

6.61.1.7 `#define COMP <`

6.61.1.8 `#define COMP >=`

6.61.1.9 `#define COMP >`

6.61.1.10 `#define COMP !=`

6.61.1.11 `#define COMP ==`

6.61.1.12 `#define COMP_CAST(x) (orreg_t)(x)`

6.61.1.13 `#define COMP_CAST(x) (orreg_t)(x)`

6.61.1.14 `#define COMP_CAST(x) (orreg_t)(x)`

6.61.1.15 `#define COMP_CAST(x) (orreg_t)(x)`

6.61.1.16 `#define COMP_CAST(x) (x)`

6.61.1.17 `#define COMP_CAST(x) (x)`

6.61.1.18 `#define COMP_CAST(x) (x)`

6.61.1.19 `#define COMP_CAST(x) (x)`

6.61.1.20 `#define COMP_CAST(x) (x)`

6.61.1.21 `#define COMP_CAST(x) (x)`

6.61.1.22 `#define COMP_NAME sfles`

6.61.1.23 `#define COMP_NAME sflts`

6.61.1.24 `#define COMP_NAME sfges`

6.61.1.25 `#define COMP_NAME sfgts`

6.61.1.26 `#define COMP_NAME sfleu`

6.61.1.27 `#define COMP_NAME sfltu`

6.61.1.28 `#define COMP_NAME sfgeu`

6.61.1.29 `#define COMP_NAME sfgtu`

6.61.1.30 `#define COMP_NAME sfne`

### 6.61.2.6 void do\_sched\_wrap\_delay (void)

Here is the call graph for this function:



### 6.61.2.7 void enter\_dyn\_code (oraddr\_t addr, struct dyn\_page \* dp)

### 6.61.2.8 \_\_or\_dynop void op\_add\_pc (void)

### 6.61.2.9 \_\_or\_dynop void op\_analysis (void)

Here is the call graph for this function:

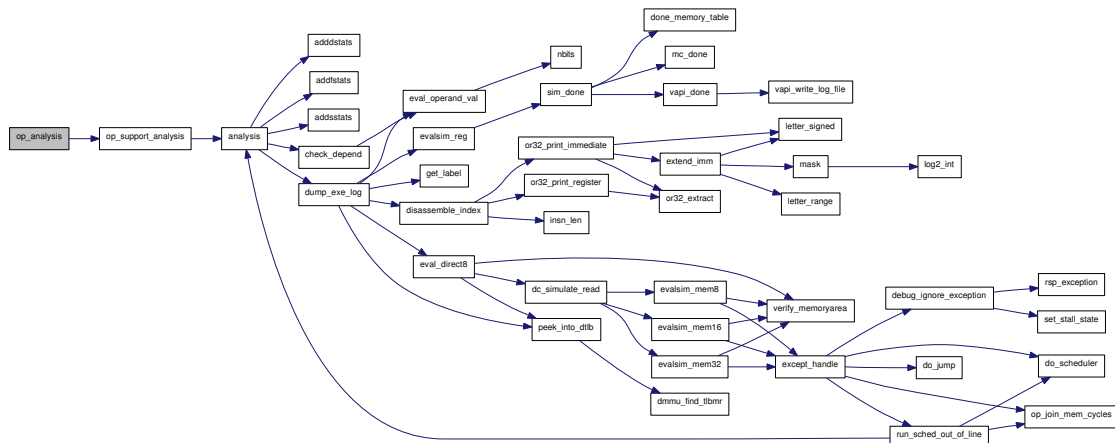

### 6.61.2.10 \_\_or\_dynop void op\_check\_delay\_slot (void)

### 6.61.2.11 \_\_or\_dynop void op\_check\_flag (void)

Here is the call graph for this function:

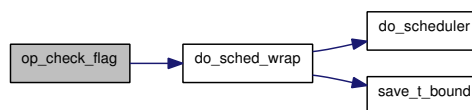



**6.61.2.12** `__or_dynop void op_check_flag_delay (void)`

**6.61.2.13** `__or_dynop void op_check_not_flag (void)`

Here is the call graph for this function:

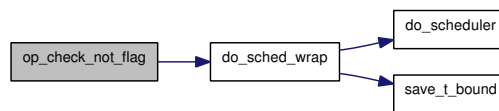

**6.61.2.14** `__or_dynop void op_check_not_flag_delay (void)`

**6.61.2.15** `__or_dynop void op_clear_delay_insn (void)`

**6.61.2.16** `__or_dynop void op_clear_flag (void)`

**6.61.2.17** `__or_dynop void op_clear_pc_delay (void)`

**6.61.2.18** `__or_dynop void op_do_jump_delay (void)`

**6.61.2.19** `__or_dynop void op_do_sched (void)`

Here is the call graph for this function:

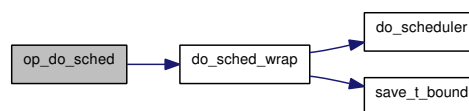

**6.61.2.20** `__or_dynop void op_do_sched_delay (void)`

Here is the call graph for this function:

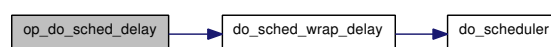



- 6.61.2.21 `__or_dynop void op_illegal (void)`
- 6.61.2.22 `__or_dynop void op_illegal_delay (void)`
- 6.61.2.23 `__or_dynop void op_jump_imm (void)`
- 6.61.2.24 `__or_dynop void op_join_mem_cycles (void)`
- 6.61.2.25 `__or_dynop void op_macc (void)`
- 6.61.2.26 `__or_dynop void op_move_gpr10_pc_delay (void)`
- 6.61.2.27 `__or_dynop void op_move_gpr11_pc_delay (void)`
- 6.61.2.28 `__or_dynop void op_move_gpr12_pc_delay (void)`
- 6.61.2.29 `__or_dynop void op_move_gpr13_pc_delay (void)`
- 6.61.2.30 `__or_dynop void op_move_gpr14_pc_delay (void)`
- 6.61.2.31 `__or_dynop void op_move_gpr15_pc_delay (void)`
- 6.61.2.32 `__or_dynop void op_move_gpr16_pc_delay (void)`
- 6.61.2.33 `__or_dynop void op_move_gpr17_pc_delay (void)`
- 6.61.2.34 `__or_dynop void op_move_gpr18_pc_delay (void)`
- 6.61.2.35 `__or_dynop void op_move_gpr19_pc_delay (void)`
- 6.61.2.36 `__or_dynop void op_move_gpr1_pc_delay (void)`
- 6.61.2.37 `__or_dynop void op_move_gpr20_pc_delay (void)`
- 6.61.2.38 `__or_dynop void op_move_gpr21_pc_delay (void)`
- 6.61.2.39 `__or_dynop void op_move_gpr22_pc_delay (void)`
- 6.61.2.40 `__or_dynop void op_move_gpr23_pc_delay (void)`
- 6.61.2.41 `__or_dynop void op_move_gpr24_pc_delay (void)`
- 6.61.2.42 `__or_dynop void op_move_gpr25_pc_delay (void)`
- 6.61.2.43 `__or_dynop void op_move_gpr26_pc_delay (void)`
- 6.61.2.44 `__or_dynop void op_move_gpr27_pc_delay (void)`
- 6.61.2.45 `__or_dynop void op_move_gpr28_pc_delay (void)`
- 6.61.2.46 `__or_dynop void op_move_gpr29_pc_delay (void)`
- 6.61.2.47 `__or_dynop void op_move_gpr2_pc_delay (void)`
- 6.61.2.48 `__or_dynop void op_move_gpr30_pc_delay (void)`

---

Generated on Tue Feb 24 14:24:06 2009 for OpenRISC 1000 by Doxygen

- 6.61.2.49 `__or_dynop void op_move_gpr31_pc_delay (void)`

- 6.61.2.50 `__or_dynop void op_move_gpr3_pc_delay (void)`

- 6.61.2.51 `__or_dynop void op_move_gpr4_pc_delay (void)`



**6.61.2.64** `__or_dynop void op_prep_sys_delay (void)`

Here is the call graph for this function:

**6.61.2.65** `__or_dynop void op_prep_trap (void)`

Here is the call graph for this function:

**6.61.2.66** `__or_dynop void op_prep_trap_delay (void)`

Here is the call graph for this function:

**6.61.2.67** `__or_dynop void op_set_delay_insn (void)`**6.61.2.68** `__or_dynop void op_set_flag (void)`**6.61.2.69** `__or_dynop void op_set_pc_delay_imm (void)`**6.61.2.70** `__or_dynop void op_set_pc_delay_pc (void)`**6.61.2.71** `__or_dynop void op_set_pc_pc_delay (void)`**6.61.2.72** `__or_dynop void op_store_insn_ea (void)`**6.61.2.73** `__or_dynop void op_store_link_addr_gpr (void)`**6.61.2.74** `static void prep_except (oraddr_t epcr_base) [inline, static]`**6.61.2.75** `static void save_t_bound (oraddr_t pc) [inline, static]`**6.61.3 Variable Documentation****6.61.3.1** `uorreg_t __op_param1`**6.61.3.2** `uorreg_t __op_param2`**6.61.3.3** `uorreg_t __op_param3`

## 6.62 cpu/or32/or32.c File Reference

```
#include "config.h"
#include "port.h"
#include <stdlib.h>
#include <stdio.h>
#include "opcode/or32.h"
```

Include dependency graph for or32.c:

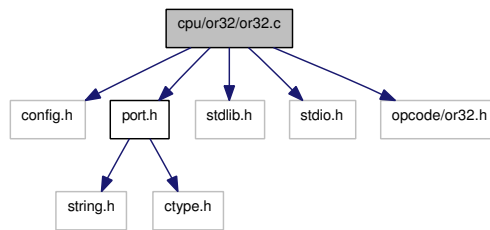

### Defines

- #define [EFN](#) &l\_none
- #define [EF\(func\)](#) EFN
- #define [EFI](#) EFN
- #define [MAX\\_AUTOMATA\\_SIZE](#) (1200)
- #define [MAX\\_OP\\_TABLE\\_SIZE](#) (1200)
- #define [MAX\\_LEN](#) (8)
- #define [MIN\(x, y\)](#) ((x) < (y) ? (x) : (y))

### Functions

- int [insn\\_len](#) (int [insn\\_index](#))
- int [letter\\_signed](#) (char l)
- int [letter\\_range](#) (char l)
- int [insn\\_index](#) (char \*[insn](#))
- CONST char \* [insn\\_name](#) (int [index](#))
- void [l\\_none](#) ()
- unsigned long [insn\\_extract](#) (char [param\\_ch](#), char \*[enc\\_initial](#))
- static void [or32\\_debug](#) (int [level](#), const char \*[format](#),...)
- static unsigned long \* [cover\\_insn](#) (unsigned long \*[cur](#), int [pass](#), unsigned int [mask](#))
- static int [num\\_ones](#) (unsigned long [value](#))
- static struct [insn\\_op\\_struct](#) \* [parse\\_params](#) (CONST struct [or32\\_opcode](#) \*[opcode](#), struct [insn\\_op\\_struct](#) \*[cur](#))
- void [build\\_automata](#) ()
- void [destruct\\_automata](#) ()
- int [insn\\_decode](#) (unsigned int [insn](#))
- unsigned long [extend\\_imm](#) (unsigned long [imm](#), char l)
- unsigned long [or32\\_extract](#) (char [param\\_ch](#), char \*[enc\\_initial](#), unsigned long [insn](#))

- static char \* [or32\\_print\\_register](#) (char \*dest, char param\_ch, char \*encoding, unsigned long [insn](#))
- static char \* [or32\\_print\\_immediate](#) (char \*dest, char param\_ch, char \*encoding, unsigned long [insn](#))
- int [disassemble\\_insn](#) (unsigned long [insn](#))
- int [disassemble\\_index](#) (unsigned long [insn](#), int index)

## Variables

- CONST struct or32\_letter [or32\\_letters](#) []
- CONST struct or32\_opcode [or32\\_opcodes](#) []
- CONST int [num\\_opcodes](#)
- static int [range\\_cache](#) [256] = { 0 }
- unsigned long \* [automata](#)
- int [nuncovered](#)
- int [curpass](#) = 0
- struct temp\_insn\_struct \* [ti](#)
- struct insn\_op\_struct \* [op\\_data](#)
- struct insn\_op\_struct \*\* [op\\_start](#)
- static char [disassembled\\_str](#) [50]
- char \* [disassembled](#) = &[disassembled\\_str](#)[0]

## 6.62.1 Define Documentation

6.62.1.1 `#define EF(func) EFN`

6.62.1.2 `#define EFI EFN`

6.62.1.3 `#define EFN &l_none`

6.62.1.4 `#define MAX_AUTOMATA_SIZE (1200)`

6.62.1.5 `#define MAX_LEN (8)`

6.62.1.6 `#define MAX_OP_TABLE_SIZE (1200)`

6.62.1.7 `#define MIN(x, y) ((x) < (y) ? (x) : (y))`

## 6.62.2 Function Documentation

6.62.2.1 `void build_automata ()`

Here is the call graph for this function:

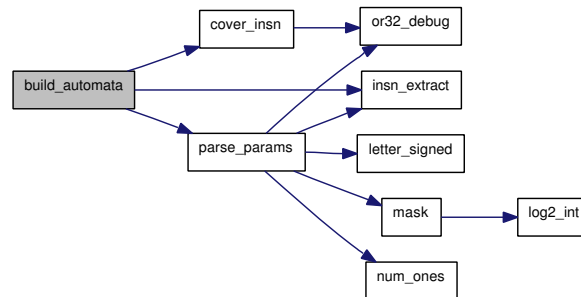

6.62.2.2 `static unsigned long* cover_insn (unsigned long * cur, int pass, unsigned int mask)`  
`[static]`

Here is the call graph for this function:





**6.62.2.3 void destruct\_automata ()****6.62.2.4 int disassemble\_index (unsigned long *insn*, int *index*)**

Here is the call graph for this function:

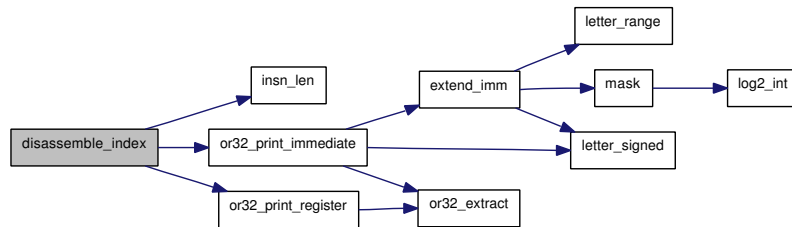
**6.62.2.5 int disassemble\_insn (unsigned long *insn*)**

Here is the call graph for this function:

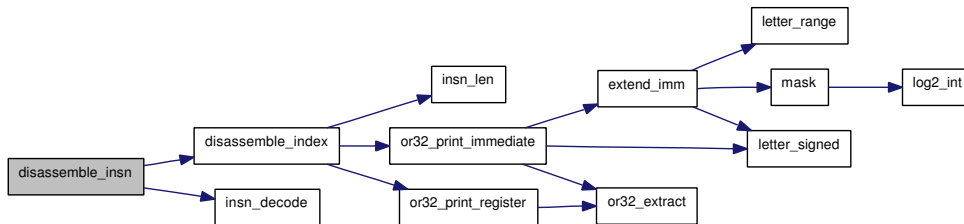
**6.62.2.6 unsigned long extend\_imm (unsigned long *imm*, char *l*)**

Here is the call graph for this function:

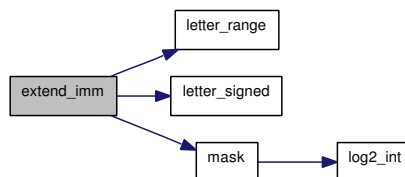

6.62.2.7 int `insn_decode` (unsigned int *insn*)

6.62.2.8 unsigned long `insn_extract` (char *param\_ch*, char \* *enc\_initial*)

6.62.2.9 int `insn_index` (char \* *insn*)

6.62.2.10 int `insn_len` (int *insn\_index*)

6.62.2.11 CONST char\* `insn_name` (int *index*)

6.62.2.12 void `l_none` ()

6.62.2.13 int `letter_range` (char *l*)

6.62.2.14 int `letter_signed` (char *l*)

6.62.2.15 static int `num_ones` (unsigned long *value*) [static]

6.62.2.16 static void `or32_debug` (int *level*, const char \* *format*, ...) [static]

6.62.2.17 unsigned long `or32_extract` (char *param\_ch*, char \* *enc\_initial*, unsigned long *insn*)

6.62.2.18 static char\* `or32_print_immediate` (char \* *dest*, char *param\_ch*, char \* *encoding*, unsigned long *insn*) [static]

Here is the call graph for this function:

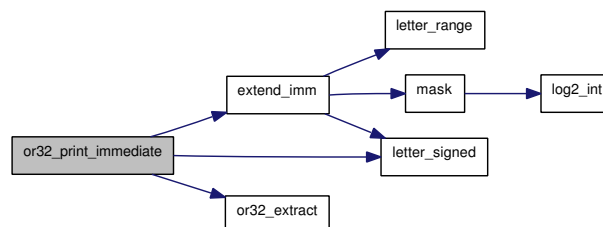

6.62.2.19 static char\* `or32_print_register` (char \* *dest*, char *param\_ch*, char \* *encoding*, unsigned long *insn*) [static]

Here is the call graph for this function:

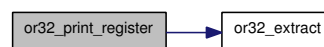

**6.62.2.20** `static struct insn_op_struct* parse_params (CONST struct or32_opcode * opcode, struct insn_op_struct * cur)` [static, read]

Here is the call graph for this function:

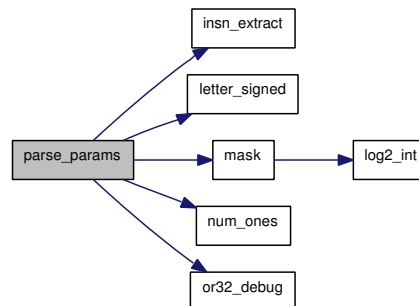

## 6.62.3 Variable Documentation

**6.62.3.1** `unsigned long* automata`

**6.62.3.2** `int curpass = 0`

**6.62.3.3** `char* disassembled = &disassembled_str[0]`

**6.62.3.4** `char disassembled_str[50]` [static]

**6.62.3.5** `CONST int num_opcodes`

**Initial value:**

```
((sizeof (or32_opcodes)) / (sizeof (struct or32_opcode))) - 1
```

**6.62.3.6** `int nuncovered`

**6.62.3.7** `struct insn_op_struct* op_data`

**6.62.3.8** `struct insn_op_struct ** op_start`

**6.62.3.9** `CONST struct or32_letter or32_letters[ ]`

**Initial value:**

```
{
  {'A', NUM_UNSIGNED},
  {'B', NUM_UNSIGNED},
  {'D', NUM_UNSIGNED},
  {'I', NUM_SIGNED},
  {'K', NUM_UNSIGNED},
  {'L', NUM_UNSIGNED},
  {'N', NUM_SIGNED},
  {'O', NUM_UNSIGNED},
  {'\0', 0}
}
```

**6.62.3.10** `CONST struct or32_opcode or32_opcodes[ ]`

**6.62.3.11** `int range_cache[256] = { 0 } [static]`

**6.62.3.12** `struct temp_insn_struct* ti`

## 6.63 `cpu/or32/rec-i386.h` File Reference

### Functions

- static void \* [get\\_sp](#) (void)

### 6.63.1 Function Documentation

#### 6.63.1.1 `static void* get_sp (void)` `[static]`

## 6.64 `cpu/or32/sched-i386.h` File Reference

### Functions

- static void `set_sched_cycle` (`int32_t job_time`)

#### 6.64.1 Function Documentation

6.64.1.1 `static void set_sched_cycle (int32_t job_time)` `[static]`

## 6.65 cpu/or32/simpl32-defs.h File Reference

```
#include "abstract.h"
```

Include dependency graph for simpl32-defs.h:

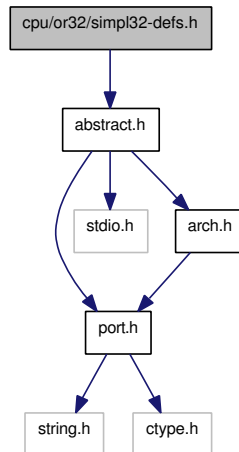

### Functions

- void `l_invalid` PARAMS ((struct `iqueue_entry` \*))
- void `l_sfgeu` PARAMS ()(struct `iqueue_entry` \*)

### 6.65.1 Function Documentation

6.65.1.1 void `l_sfgeu` PARAMS ()

6.65.1.2 void `l_none` PARAMS ((struct `iqueue_entry` \*))

## 6.66 cuc/adv.c File Reference

```
#include <stdio.h>
#include <stdlib.h>
#include <stdarg.h>
#include <assert.h>
#include "config.h"
#include "port.h"
#include "arch.h"
#include "sim-config.h"
#include "abstract.h"
#include "cuc.h"
#include "insn.h"
#include "support/profile.h"
#include "misc.h"
```

Include dependency graph for adv.c:

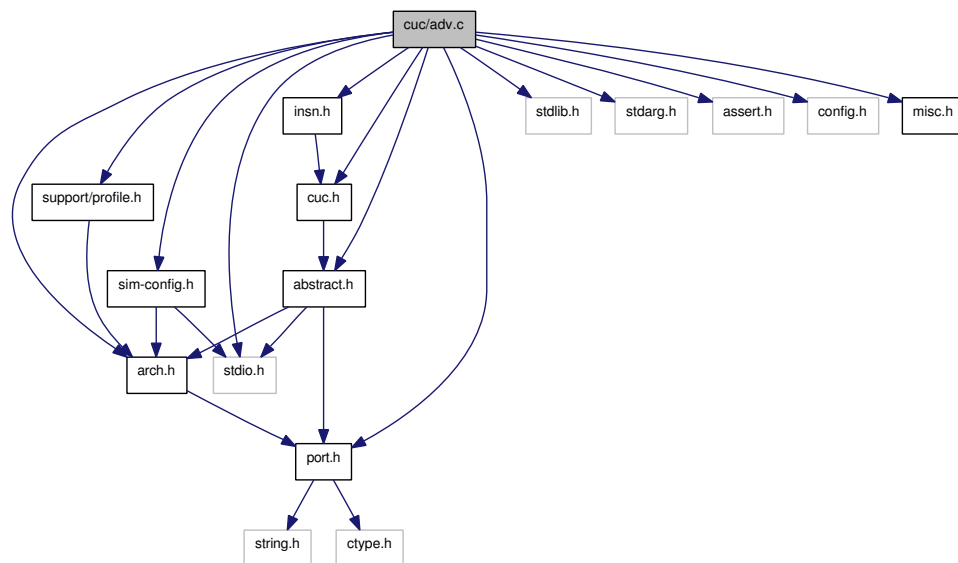

## Functions

- static void [mark\\_successors](#) ([cuc\\_func](#) \*f, int b, int m, int stopb)
- static unsigned long [mask](#) (unsigned long c)
- void [insert\\_conditional\\_facts](#) ([cuc\\_func](#) \*f)
- static unsigned long [max\\_op](#) ([cuc\\_func](#) \*f, int ref, int o)
- static unsigned long [calc\\_max](#) ([cuc\\_func](#) \*f, int ref)
- void [detect\\_max\\_values](#) ([cuc\\_func](#) \*f)



## 6.66.1 Function Documentation

### 6.66.1.1 static unsigned long calc\_max (cuc\_func \*f, int ref) [static]

Here is the call graph for this function:



### 6.66.1.2 void detect\_max\_values (cuc\_func \*f)

Here is the call graph for this function:

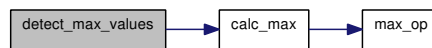

### 6.66.1.3 void insert\_conditional\_facts (cuc\_func \*f)

Here is the call graph for this function:

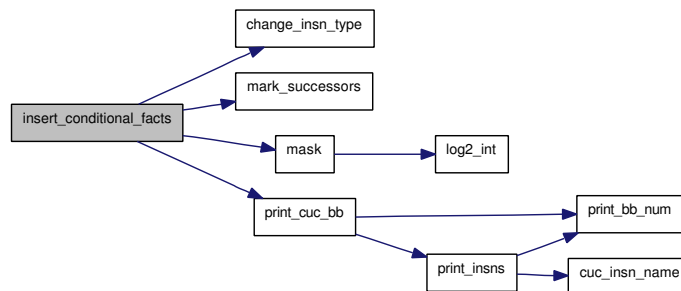

### 6.66.1.4 static void mark\_successors (cuc\_func \*f, int b, int m, int stopb) [static]

### 6.66.1.5 static unsigned long mask (unsigned long c) [static]

Here is the call graph for this function:



### 6.66.1.6 static unsigned long max\_op (cuc\_func \*f, int ref, int o) [static]

## 6.67 cuc/bb.c File Reference

```
#include <stdio.h>
#include <stdlib.h>
#include <stdarg.h>
#include <assert.h>
#include "config.h"
#include "port.h"
#include "arch.h"
#include "sim-config.h"
#include "abstract.h"
#include "cuc.h"
#include "insn.h"
#include "support/profile.h"
```

Include dependency graph for bb.c:

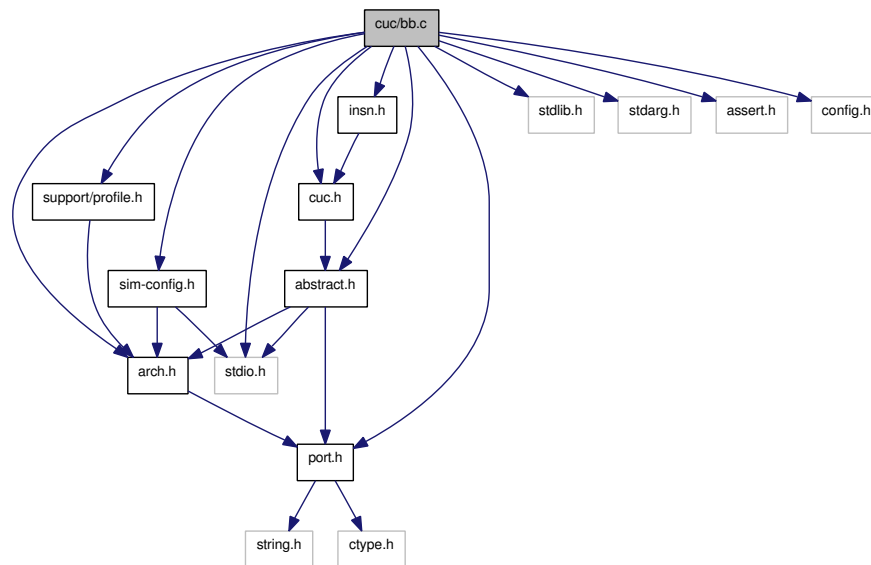

## Functions

- void [print\\_bb\\_num](#) (int num)
- void [print\\_cuc\\_bb](#) (cuc\_func \*f, char \*s)
- void [cpy\\_bb](#) (cuc\_bb \*dest, cuc\_bb \*src)
- cuc\_func \* [dup\\_func](#) (cuc\_func \*f)
- void [free\\_func](#) (cuc\_func \*f)
- void [recalc\\_last\\_used\\_reg](#) (cuc\_func \*f, int b)
- void [detect\\_bb](#) (cuc\_func \*f)
- void [cuc\\_check](#) (cuc\_func \*f)

- void `build_bb` (`cuc_func *f`)
- static void `simplify_bb` (`cuc_func *f`, int pred, int s1, int s2, int neg)
- static void `join_bb` (`cuc_func *f`, int pred, int succ, int type)
- int `optimize_bb` (`cuc_func *f`)
- int `remove_dead_bb` (`cuc_func *f`)
- static void `reg_dep_rec` (`cuc_func *f`, int cur)
- void `reg_dep` (`cuc_func *f`)
- void `expand_bb` (`cuc_func *f`, int b)
- void `generate_bb_seq` (`cuc_func *f`, char \*mp\_filename, char \*bb\_filename)
- void `count_bb_seq` (`cuc_func *f`, int b, char \*bb\_filename, int \*counts, int preroll, int unroll)
- static void `relocate_bb` (`cuc_bb *bb`, int b, int back, int fwd)
- static `cuc_func *` `roll_loop` (`cuc_func *f`, int b, int ntimes, int type)
- `cuc_func *` `preunroll_loop` (`cuc_func *f`, int b, int preroll, int unroll, char \*bb\_filename)

## 6.67.1 Function Documentation

### 6.67.1.1 void `build_bb` (`cuc_func *f`)

Here is the call graph for this function:

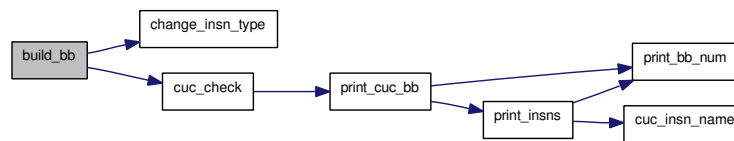

### 6.67.1.2 void `count_bb_seq` (`cuc_func *f`, int *b*, char \* *bb\_filename*, int \* *counts*, int *preroll*, int *unroll*)

### 6.67.1.3 void `cpy_bb` (`cuc_bb *dest`, `cuc_bb *src`)

Here is the call graph for this function:



### 6.67.1.4 void `cuc_check` (`cuc_func *f`)

Here is the call graph for this function:

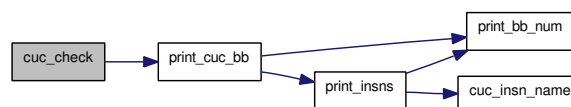

### 6.67.1.5 void detect\_bb (cuc\_func \*f)

Here is the call graph for this function:

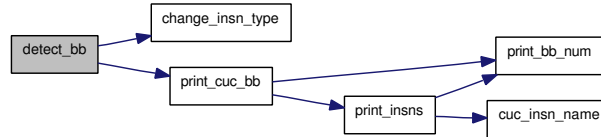

### 6.67.1.6 cuc\_func\* dup\_func (cuc\_func \*f)

Here is the call graph for this function:

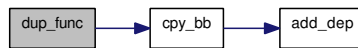

### 6.67.1.7 void expand\_bb (cuc\_func \*f, int b)

Here is the call graph for this function:

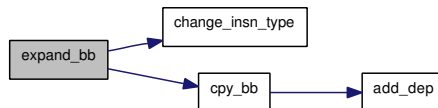

### 6.67.1.8 void free\_func (cuc\_func \*f)

Here is the call graph for this function:



### 6.67.1.9 void generate\_bb\_seq (cuc\_func \*f, char \*mp\_filename, char \*bb\_filename)

Here is the call graph for this function:



### 6.67.1.10 static void join\_bb (cuc\_func \*f, int pred, int succ, int type) [static]

Here is the call graph for this function:

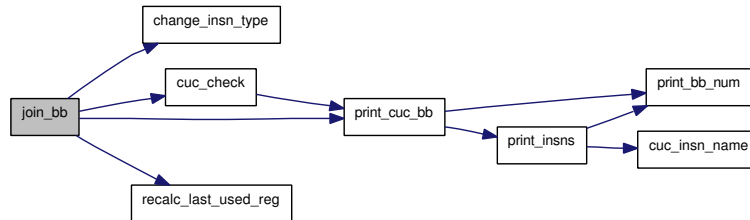

### 6.67.1.11 int optimize\_bb (cuc\_func \*f)

Here is the call graph for this function:

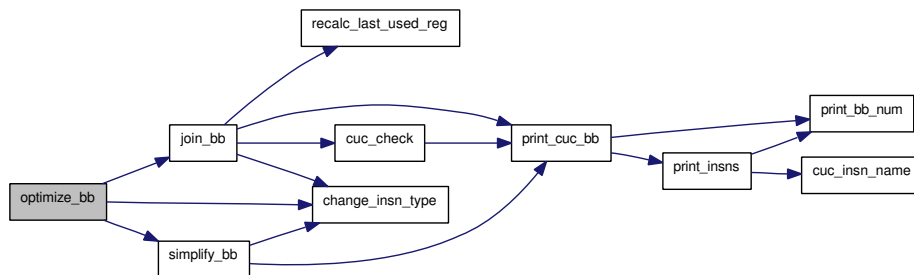

### 6.67.1.12 cuc\_func\* preunroll\_loop (cuc\_func \*f, int b, int preroll, int unroll, char \*bb\_filename)

Here is the call graph for this function:

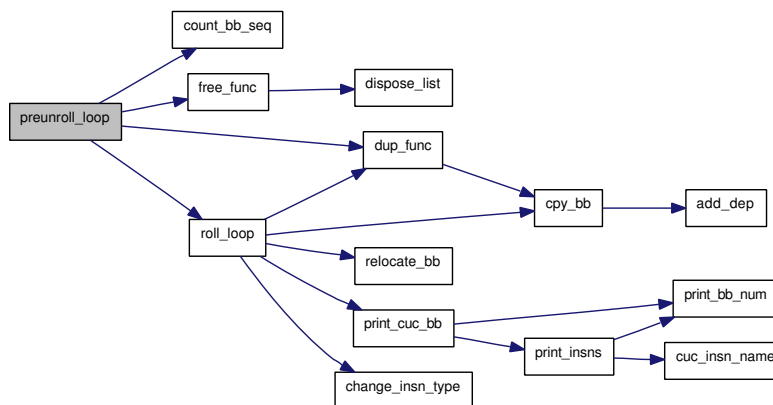

**6.67.1.13** void `print_bb_num` (int *num*)

**6.67.1.14** void `print_cuc_bb` (cuc\_func \**f*, char \**s*)

Here is the call graph for this function:

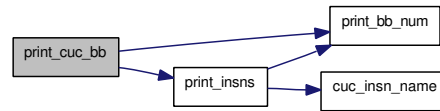

**6.67.1.15** void `recalc_last_used_reg` (cuc\_func \**f*, int *b*)

**6.67.1.16** void `reg_dep` (cuc\_func \**f*)

Here is the call graph for this function:

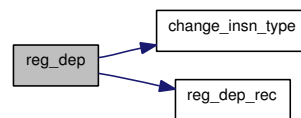

**6.67.1.17** static void `reg_dep_rec` (cuc\_func \**f*, int *cur*) [static]

**6.67.1.18** static void `relocate_bb` (cuc\_bb \**bb*, int *b*, int *back*, int  *fwd*) [static]

**6.67.1.19** int `remove_dead_bb` (cuc\_func \**f*)

**6.67.1.20** static cuc\_func\* `roll_loop` (cuc\_func \**f*, int *b*, int *ntimes*, int *type*) [static]

Here is the call graph for this function:

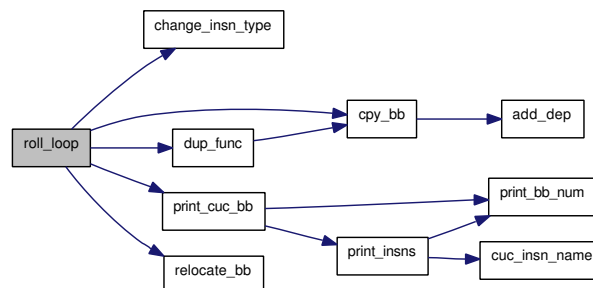

**6.67.1.21** `static void simplify_bb (cuc_func *f, int pred, int s1, int s2, int neg)` [static]

Here is the call graph for this function:

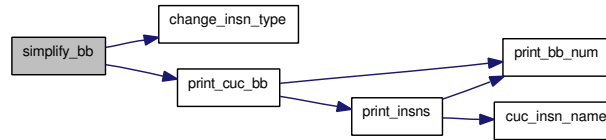

## 6.68 cuc/cuc.c File Reference

```
#include "config.h"
#include "port.h"
#include <stdlib.h>
#include <unistd.h>
#include <assert.h>
#include "cuc.h"
#include "sim-config.h"
#include "profiler.h"
#include "insn.h"
#include "opcode/or32.h"
#include "parse.h"
#include "verilog.h"
#include "debug.h"
```

Include dependency graph for cuc.c:

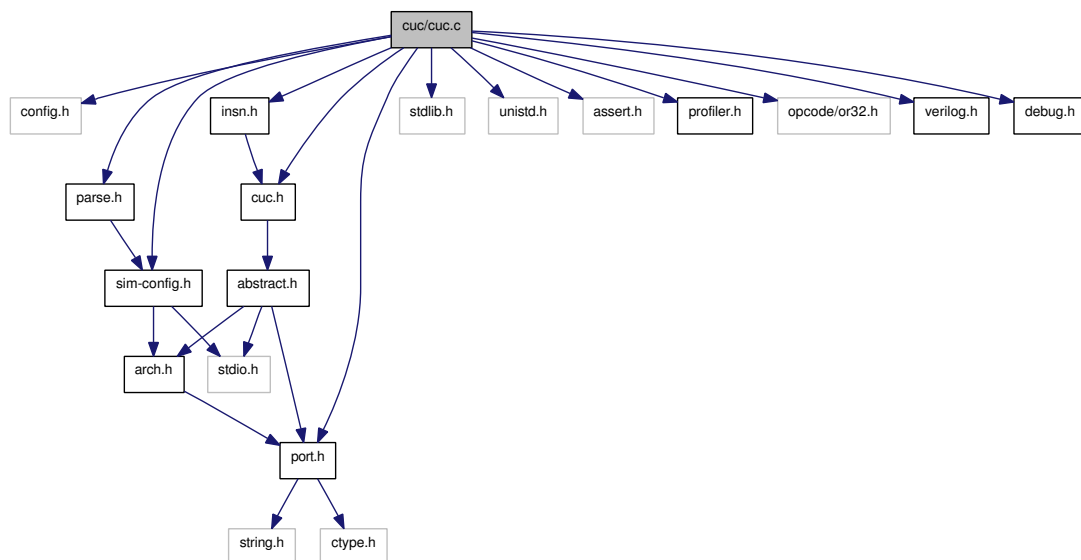

## Functions

- void [cuc\\_optimize](#) ([cuc\\_func](#) \*func)
- [cuc\\_timings](#) \*preunroll\_bb (char \*bb\_filename, [cuc\\_func](#) \*f, [cuc\\_timings](#) \*timings, int b, int i, int j)
- int [tim\\_comp](#) ([cuc\\_timings](#) \*a, [cuc\\_timings](#) \*b)
- [cuc\\_func](#) \* [analyse\\_function](#) (char \*module\_name, long orig\_time, unsigned long [start\\_addr](#), unsigned long [end\\_addr](#), int memory\_order, int num\_runs)
- char \* [gen\\_option](#) (char \*s, int bb\_no, int f\_opt)
- void [print\\_option](#) (int bb\_no, int f\_opt)



- static char \* [format\\_func\\_options](#) (char \*s, [cuc\\_func](#) \*f)
- static void [options\\_cmd](#) (int func\_no, [cuc\\_func](#) \*f)
- [cuc\\_func](#) \* [generate\\_function](#) ([cuc\\_func](#) \*rf, char \*name, char \*cut\_filename)
- int [calc\\_cycles](#) ([cuc\\_func](#) \*f)
- double [calc\\_size](#) ([cuc\\_func](#) \*f)
- unsigned long [extract\\_function](#) (char \*out\_fn, unsigned long start\_addr)
- static void [set\\_func\\_deps](#) ()
- void [main\\_cuc](#) (char \*filename)
- static void [cuc\\_memory\\_order](#) (union [param\\_val](#) val, void \*dat)
- static void [cuc\\_calling\\_conv](#) (union [param\\_val](#) val, void \*dat)
- static void [cuc\\_enable\\_bursts](#) (union [param\\_val](#) val, void \*dat)
- static void [cuc\\_no\\_multicycle](#) (union [param\\_val](#) val, void \*dat)
- static void [cuc\\_timings\\_fn](#) (union [param\\_val](#) val, void \*dat)
- void [reg\\_cuc\\_sec](#) ()

## Variables

- FILE \* [flog](#)
- int [cuc\\_debug](#) = 0
- const int [caller\\_saved](#) [MAX\_REGS]
- static const char \* [option\\_char](#)
- static [cuc\\_func](#) \* [func](#) [MAX\_FUNCS]
- static int [func\\_v](#) [MAX\_FUNCS]



## 6.68.1 Function Documentation

### 6.68.1.1 cuc\_func\* analyse\_function (char \* module\_name, long orig\_time, unsigned long start\_addr, unsigned long end\_addr, int memory\_order, int num\_runs)

Here is the call graph for this function:

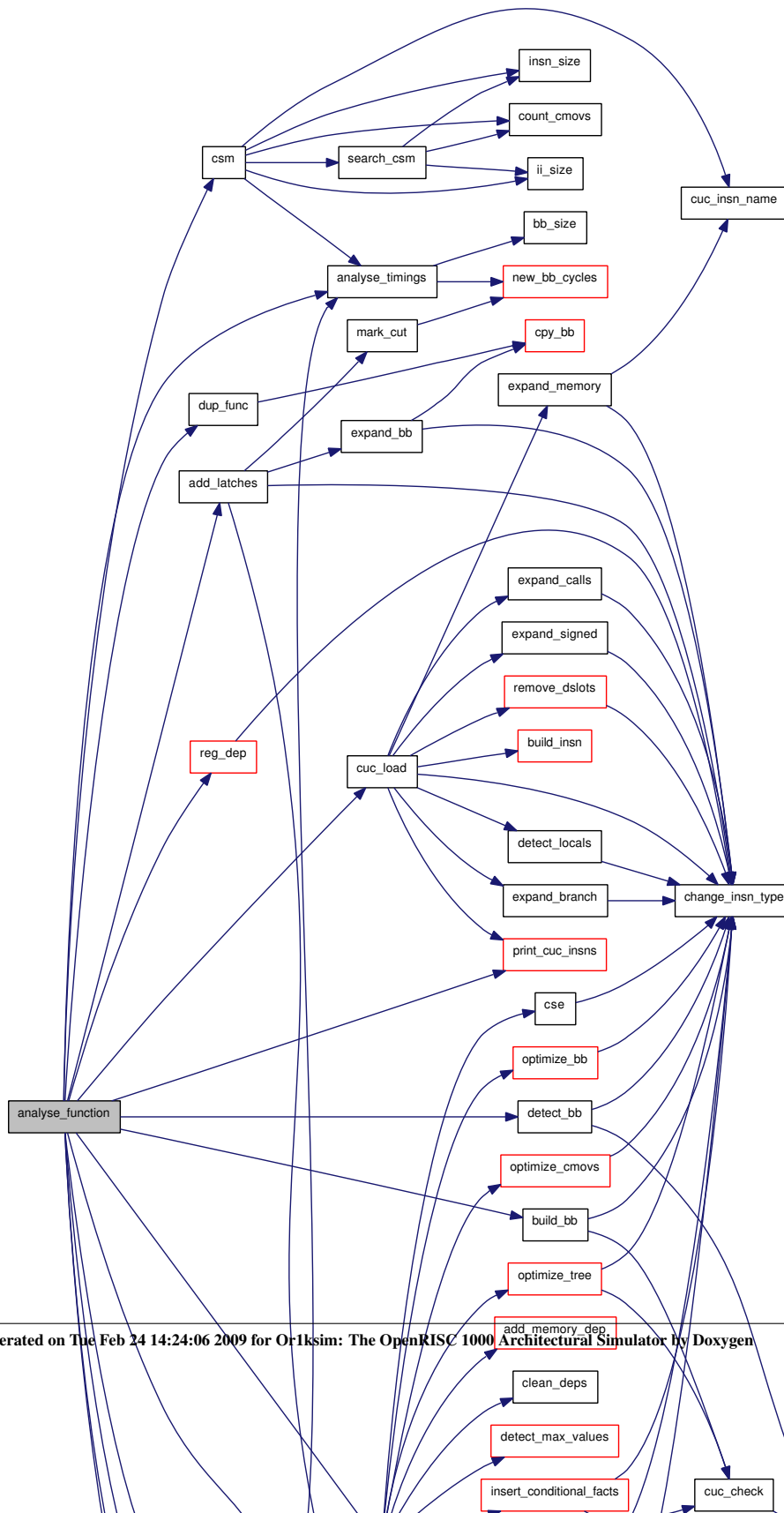

**6.68.1.2** `int calc_cycles (cuc_func *f)`

**6.68.1.3** `double calc_size (cuc_func *f)`

**6.68.1.4** `static void cuc_calling_conv (union param_val val, void *dat)` [static]

**6.68.1.5** `static void cuc_enable_bursts (union param_val val, void *dat)` [static]

**6.68.1.6** `static void cuc_memory_order (union param_val val, void *dat)` [static]

Set the memory order

Value must be one of none, weak, strong or exact. Invalid values are ignored with a warning.

**Parameters:**

← *val* The value to use

← *dat* The [config](#) data structure (not used here)

**6.68.1.7** `static void cuc_no_multicycle (union param_val val, void * dat)` [static]

**6.68.1.8** `void cuc_optimize (cuc_func * func)`

Here is the call graph for this function:

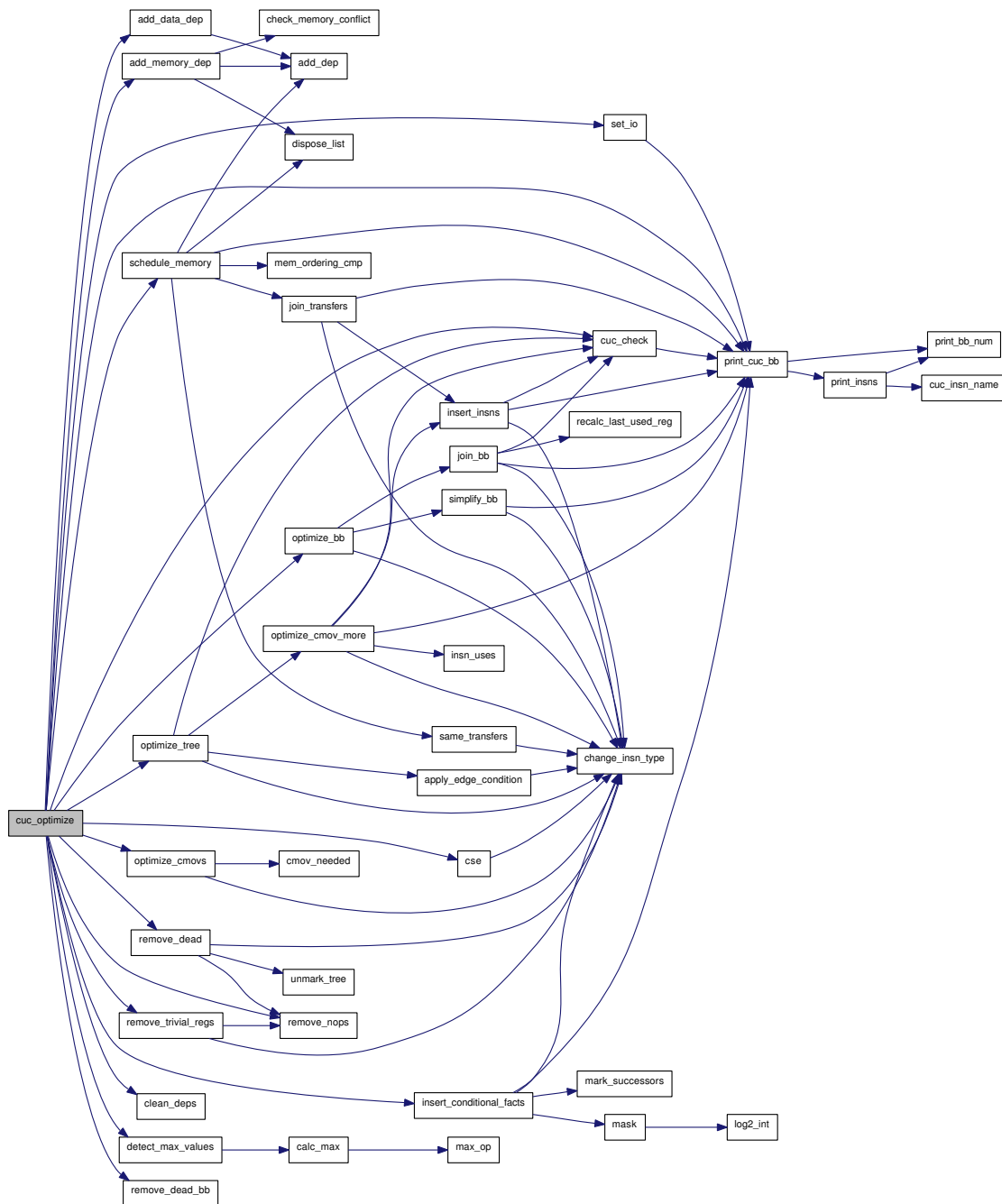

### 6.68.1.9 static void cuc\_timings\_fn (union param\_val val, void \* dat) [static]

Set the timings file

Free any existing string.

#### Parameters:

← *val* The value to use

← *dat* The [config](#) data structure (not used here)

### 6.68.1.10 unsigned long extract\_function (char \* out\_fn, unsigned long start\_addr)

Here is the call graph for this function:

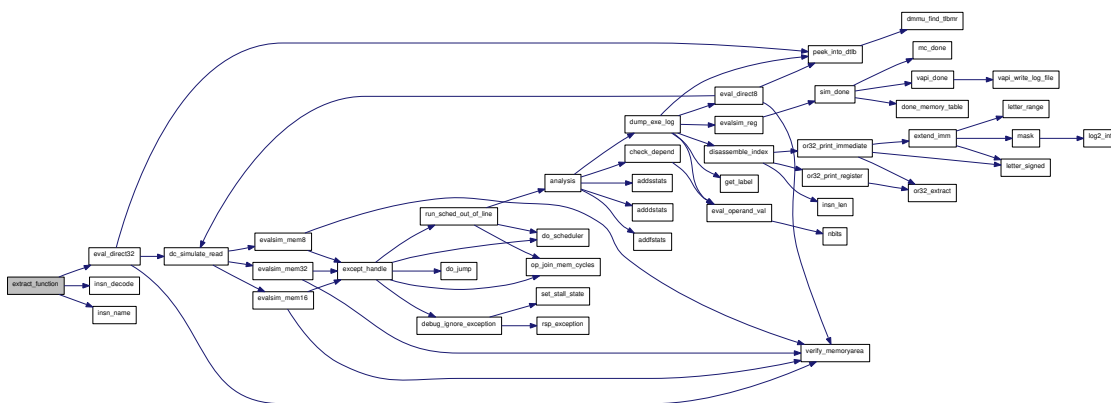

### 6.68.1.11 static char\* format\_func\_options (char \* s, cuc\_func \* f) [static]

Here is the call graph for this function:











### 6.68.1.14 void main\_cuc (char \* filename)

Here is the call graph for this function:

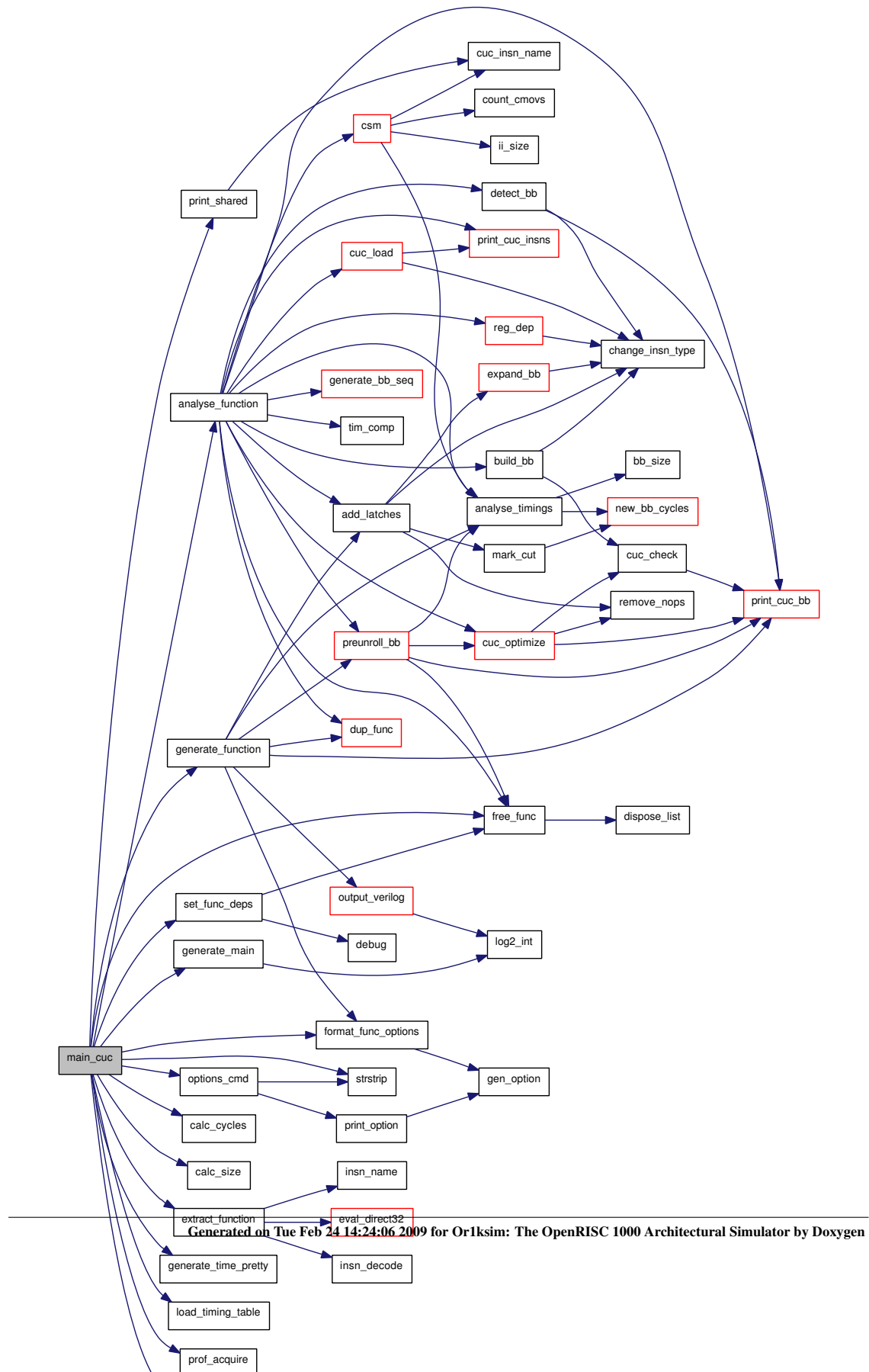

**6.68.1.15** `static void options_cmd (int func_no, cuc_func *f)` [static]

Here is the call graph for this function:

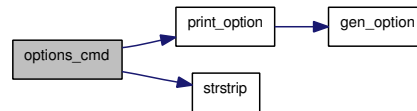



6.68.1.16 cuc\_timings\* preunroll\_bb (char \* bb\_filename, cuc\_func \* f, cuc\_timings \* timings, int b, int i, int j)

Here is the call graph for this function:

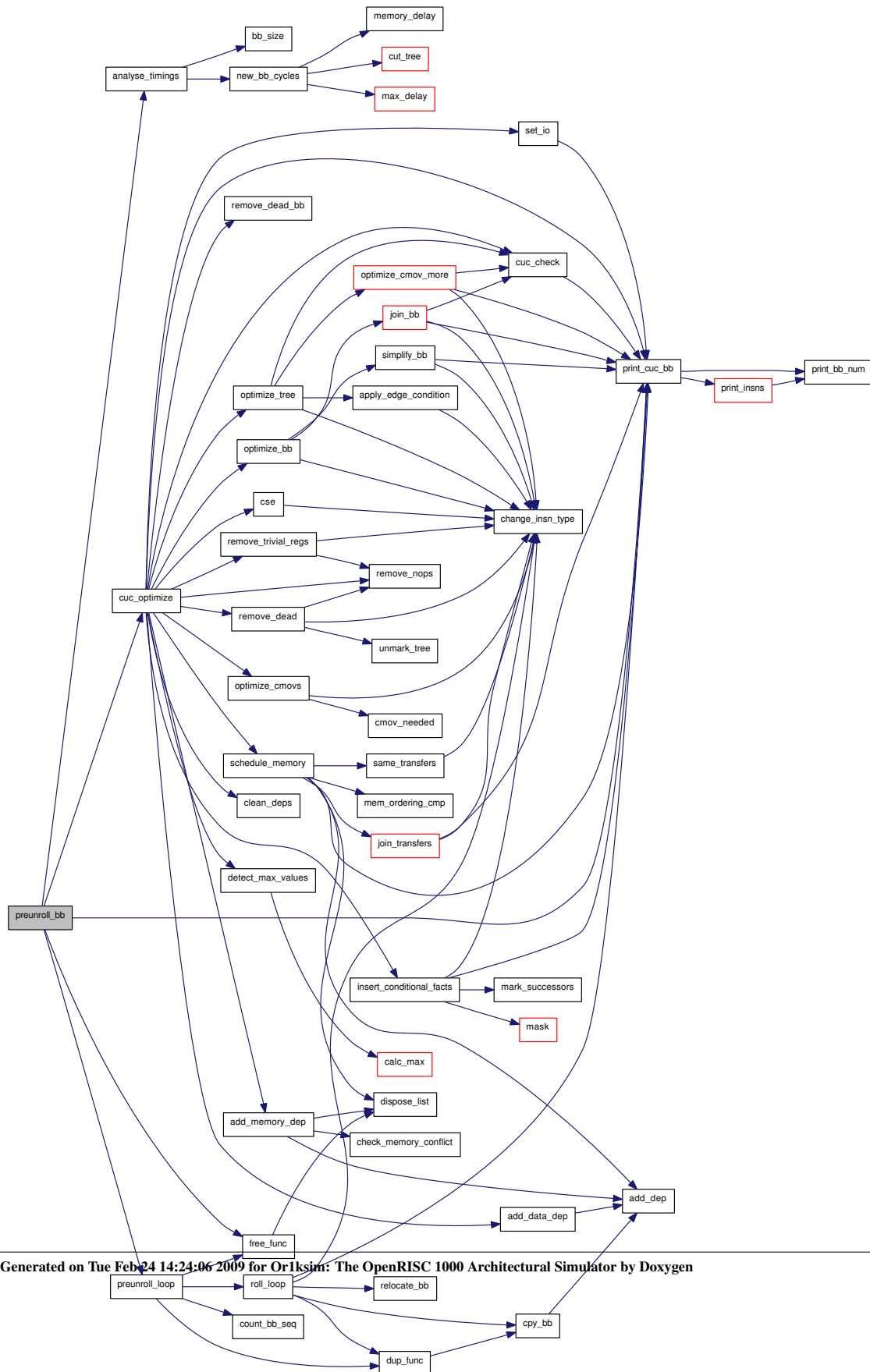

### 6.68.1.17 void print\_option (int *bb\_no*, int *f\_opt*)

Here is the call graph for this function:



### 6.68.1.18 void reg\_cuc\_sec ()

Here is the call graph for this function:

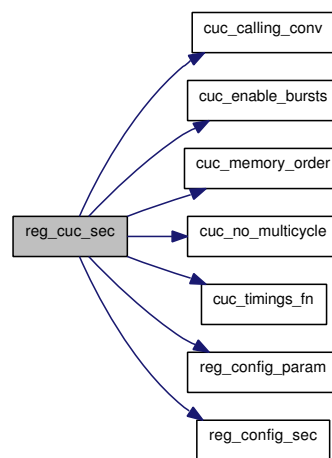

### 6.68.1.19 static void set\_func\_deps () [static]

Here is the call graph for this function:

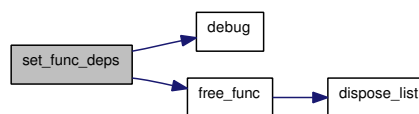

### 6.68.1.20 int tim\_comp (cuc\_timings \* *a*, cuc\_timings \* *b*)

## 6.68.2 Variable Documentation

### 6.68.2.1 const int caller\_saved[MAX\_REGS]

**Initial value:**

```

{
  0, 0, 0, 1, 1, 1, 1, 1,
  1, 1, 0, 0, 0, 1, 0, 1,

```

```
    0, 1, 0, 1, 0, 1, 0, 1,  
    0, 1, 0, 1, 0, 1, 0, 1,  
    1, 1  
}
```

**6.68.2.2** `int cuc_debug = 0`

**6.68.2.3** `FILE* flog`

**6.68.2.4** `cuc_func* func[MAX_FUNCS]` [static]

**6.68.2.5** `int func_v[MAX_FUNCS]` [static]

**6.68.2.6** `const char* option_char` [static]

**Initial value:**

```
"?abcdefghijklmnopqrstuvwxyzABCDEFGHIJKLMNOPQRSTUVWXYZ"
```

## 6.69 cuc/cuc.h File Reference

```
#include "abstract.h"
```

Include dependency graph for cuc.h:

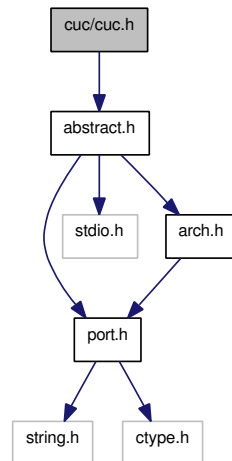

This graph shows which files directly or indirectly include this file:

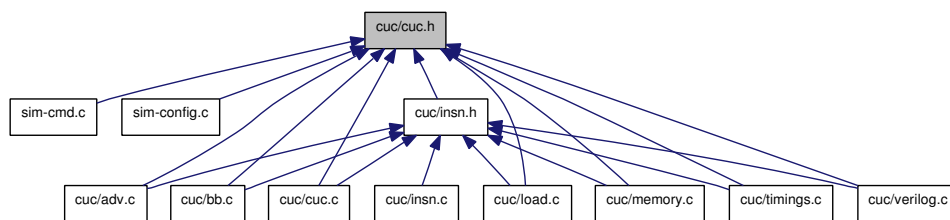

### Data Structures

- struct [\\_dep\\_list\\_t](#)
- struct [\\_csm\\_list](#)
- struct [cuc\\_shared\\_item](#)
- struct [cuc\\_timings](#)
- struct [cuc\\_insn](#)
- struct [cuc\\_bb](#)
- struct [\\_cuc\\_func](#)

### Defines

- #define [MAX\\_INSNS](#) 0x10000
- #define [MAX\\_BB](#) 0x1000
- #define [MAX\\_REGS](#) 34
- #define [FLAG\\_REG](#) (MAX\_REGS - 2)
- #define [LRBB\\_REG](#) (MAX\_REGS - 1)



- #define CUC\_MAX\_STACK 0x1000
- #define MAX\_PREROLL 32
- #define MAX\_UNROLL 32
- #define IT\_BRANCH 0x0001
- #define IT\_INDELAY 0x0002
- #define IT\_BBSTART 0x0004
- #define IT\_BBEND 0x0008
- #define IT\_OUTPUT 0x0010
- #define IT\_SIGNED 0x0020
- #define IT\_MEMORY 0x0040
- #define IT\_UNUSED 0x0080
- #define IT\_FLAG1 0x0100
- #define IT\_FLAG2 0x0200
- #define IT\_VOLATILE 0x0400
- #define IT\_MEMADD 0x0800
- #define IT\_COND 0x1000
- #define IT\_LATCHED 0x2000
- #define IT\_CUT 0x4000
- #define OPT\_NONE 0x00
- #define OPT\_CONST 0x01
- #define OPT\_REGISTER 0x02
- #define OPT\_REF 0x04
- #define OPT\_JUMP 0x08
- #define OPT\_DEST 0x10
- #define OPT\_BB 0x20
- #define OPT\_LRBB 0x40
- #define MT\_WIDTH 0x007
- #define MT\_BURST 0x008
- #define MT\_BURSTE 0x010
- #define MT\_CALL 0x020
- #define MT\_LOAD 0x040
- #define MT\_STORE 0x080
- #define MT\_SIGNED 0x100
- #define MO\_NONE 0
- #define MO\_WEAK 1
- #define MO\_STRONG 2
- #define MO\_EXACT 3
- #define BB\_INLOOP 0x01
- #define BB\_OPTIONAL 0x02
- #define BB\_DEAD 0x08
- #define BBID\_START MAX\_BB
- #define BBID\_END (MAX\_BB + 1)
- #define REF(bb, i) (((bb) \* MAX\_INSNS) + (i))
- #define REF\_BB(r) ((r) / MAX\_INSNS)
- #define REF\_I(r) ((r) % MAX\_INSNS)
- #define INSN(ref) bb[REF\_BB(ref)].insn[REF\_I(ref)]
- #define MIN(x, y) ((x) < (y) ? (x) : (y))
- #define MAX(x, y) ((x) > (y) ? (x) : (y))
- #define log(x...) { fprintf (flog, x); fflush (flog); }
- #define cucdebug(x, s...) { if ((x) <= cuc\_debug) PRINTF (s); }
- #define CUC\_WIDTH\_ITERATIONS 256

## Typedefs

- typedef struct `_dep_list_t` `dep_list`
- typedef struct `_csm_list` `cuc_shared_list`
- typedef struct `_cuc_func` `cuc_func`

## Functions

- int `cuc_load` (char \*in\_fn)
- void `negate_conditional` (cuc\_insn \*ii)
- void `generate_bb_seq` (cuc\_func \*f, char \*mp\_filename, char \*bb\_filename)
- void `print_insns` (int bb, cuc\_insn \*insns, int size, int verbose)
- void `print_bb_num` (int num)
- void `print_cuc_bb` (cuc\_func \*func, char \*s)
- cuc\_func \* `dup_func` (cuc\_func \*f)
- void `free_func` (cuc\_func \*f)
- void `csm` (cuc\_func \*f)
- void `csm_gen` (cuc\_func \*f, cuc\_func \*rf, cuc\_shared\_item \*shared, int nshared)
- void `detect_bb` (cuc\_func \*func)
- int `optimize_bb` (cuc\_func \*func)
- int `optimize_cmovs` (cuc\_func \*func)
- int `optimize_tree` (cuc\_func \*func)
- int `remove_nops` (cuc\_func \*func)
- int `remove_dead` (cuc\_func \*func)
- int `remove_trivial_regs` (cuc\_func \*f)
- void `set_io` (cuc\_func \*func)
- int `remove_dead_bb` (cuc\_func \*func)
- int `cse` (cuc\_func \*f)
- void `reg_dep` (cuc\_func \*func)
- void `mark_cut` (cuc\_func \*f)
- cuc\_func \* `preunroll_loop` (cuc\_func \*func, int b, int preroll, int unroll, char \*bb\_filename)
- void `clean_deps` (cuc\_func \*func)
- int `schedule_memory` (cuc\_func \*func, int otype)
- void `recalc_cnts` (cuc\_func \*f, char \*bb\_filename)
- void `analyse_timings` (cuc\_func \*func, cuc\_timings \*timings)
- void `insert_conditional_facts` (cuc\_func \*func)
- void `detect_max_values` (cuc\_func \*f)
- void `insert_insns` (cuc\_func \*f, int ref, int n)
- void `cuc_check` (cuc\_func \*f)
- void `add_memory_dep` (cuc\_func \*f, int otype)
- void `print_cuc_insns` (char \*s, int verbose)
- void `build_bb` (cuc\_func \*f)
- void `add_latches` (cuc\_func \*f)
- void `expand_bb` (cuc\_func \*f, int b)
- void `add_dep` (dep\_list \*\*list, int dep)
- void `dispose_list` (dep\_list \*\*list)
- void `main_cuc` (char \*filename)
- void `add_data_dep` (cuc\_func \*f)
- void `reg_cuc_sec` ()

## Variables

- int [cuc\\_debug](#)
  
- const int [caller\\_saved](#) [MAX\_REGS]
  
- [cuc\\_insn](#) [insn](#) [MAX\_INSNS]
  
- int [num\\_insn](#)
  
- int [reloc](#) [MAX\_INSNS]
  
- FILE \* [flog](#)



## 6.69.1 Define Documentation

6.69.1.1 `#define BB_DEAD 0x08`

6.69.1.2 `#define BB_INLOOP 0x01`

6.69.1.3 `#define BB_OPTIONAL 0x02`

6.69.1.4 `#define BBID_END (MAX_BB + 1)`

6.69.1.5 `#define BBID_START MAX_BB`

6.69.1.6 `#define CUC_MAX_STACK 0x1000`

6.69.1.7 `#define CUC_WIDTH_ITERATIONS 256`

6.69.1.8 `#define cucdebug(x, s...) {if ((x) <= cuc_debug) PRINTF (s);}`

6.69.1.9 `#define FLAG_REG (MAX_REGS - 2)`

6.69.1.10 `#define INSN(ref) bb[REF_BB(ref)].insn[REF_I(ref)]`

6.69.1.11 `#define IT_BBEND 0x0008`

6.69.1.12 `#define IT_BBSTART 0x0004`

6.69.1.13 `#define IT_BRANCH 0x0001`

6.69.1.14 `#define IT_COND 0x1000`

6.69.1.15 `#define IT_CUT 0x4000`

6.69.1.16 `#define IT_FLAG1 0x0100`

6.69.1.17 `#define IT_FLAG2 0x0200`

6.69.1.18 `#define IT_INDELAY 0x0002`

6.69.1.19 `#define IT_LATCHED 0x2000`

6.69.1.20 `#define IT_MEMADD 0x0800`

6.69.1.21 `#define IT_MEMORY 0x0040`

6.69.1.22 `#define IT_OUTPUT 0x0010`

6.69.1.23 `#define IT_SIGNED 0x0020`

6.69.1.24 `#define IT_UNUSED 0x0080`

6.69.1.25 `#define IT_VOLATILE 0x0400`

6.69.1.26 `#define log(x...) {fprintf (flog, x); fflush (flog); }`

6.69.1.27 `#define LBB_REG (MAX_REGS - 1)`  
Generated on Tue Feb 24 14:42:30 2009 for OpenSim: The OpenRISC 1000 Architectural Simulator by Doxygen

6.69.1.28 `#define MAX(x, y) ((x) > (y) ? (x) : (y))`

6.69.1.29 `#define MAX_BB 0x1000`

6.69.1.30 `#define MAX_INSNS 0x10000`

### 6.69.3.2 void add\_dep (dep\_list \*\* list, int dep)

### 6.69.3.3 void add\_latches (cuc\_func \* f)

Here is the call graph for this function:

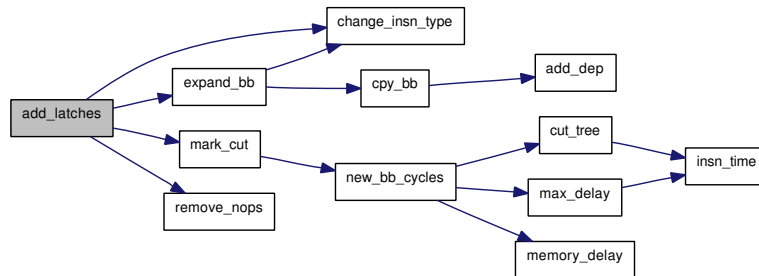

### 6.69.3.4 void add\_memory\_dep (cuc\_func \* f, int otype)

Here is the call graph for this function:

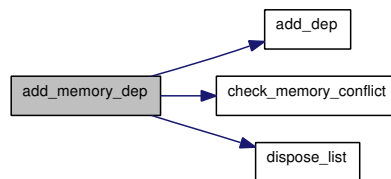

### 6.69.3.5 void analyse\_timings (cuc\_func \* func, cuc\_timings \* timings)

Here is the call graph for this function:

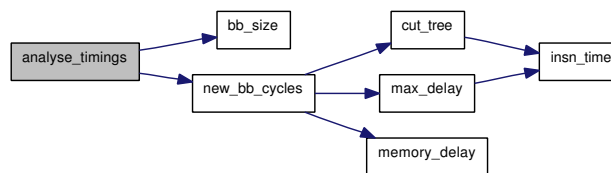

### 6.69.3.6 void build\_bb (cuc\_func \* f)

Here is the call graph for this function:

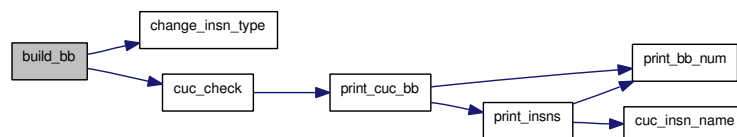

**6.69.3.7 void clean\_deps (cuc\_func \*func)****6.69.3.8 int cse (cuc\_func \*f)**

Here is the call graph for this function:

**6.69.3.9 void csm (cuc\_func \*f)**

Here is the call graph for this function:

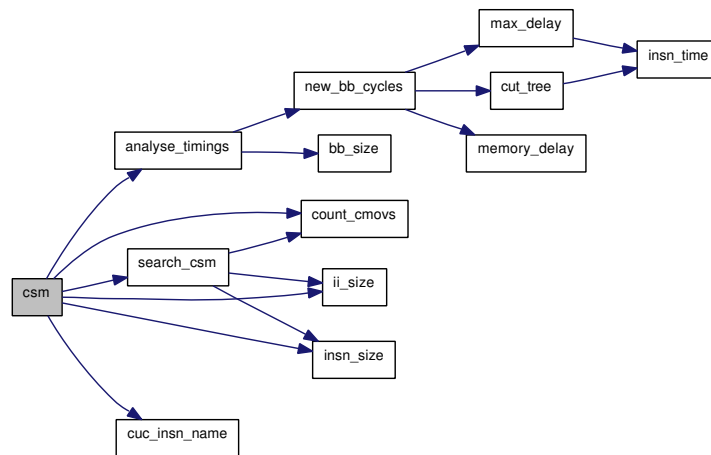
**6.69.3.10 void csm\_gen (cuc\_func \*f, cuc\_func \*rf, cuc\_shared\_item \*shared, int nshared)**

Here is the call graph for this function:

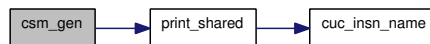
**6.69.3.11 void cuc\_check (cuc\_func \*f)**

Here is the call graph for this function:

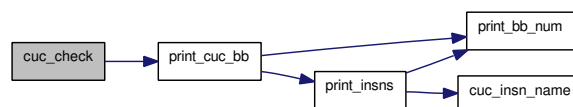

### 6.69.3.12 int cuc\_load (char \* in\_fn)

Here is the call graph for this function:

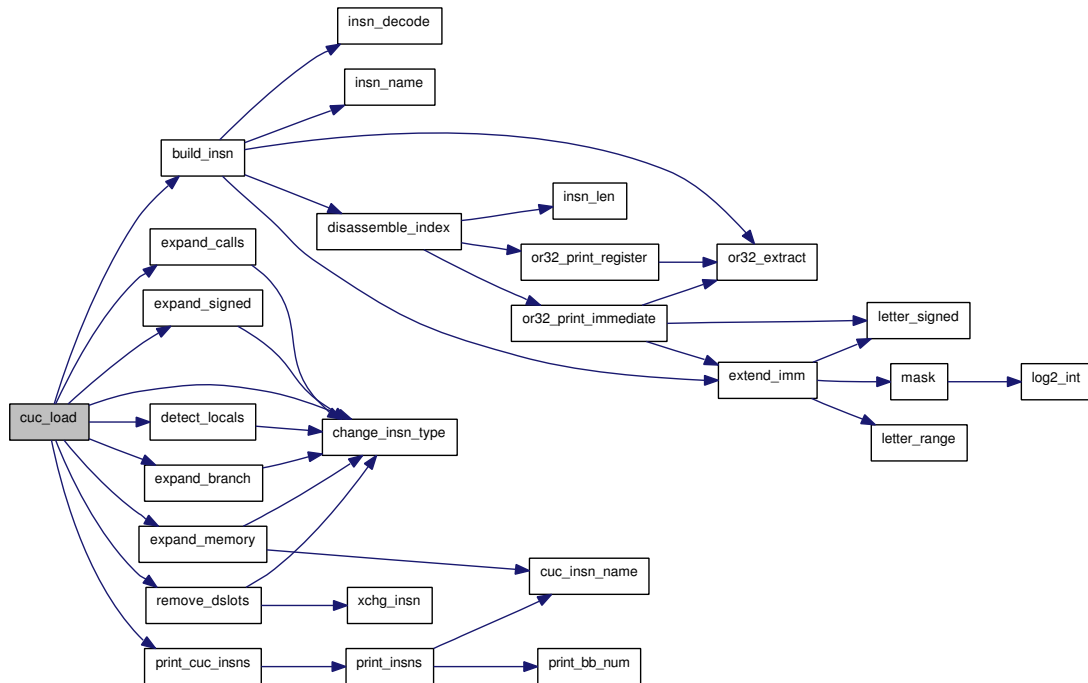

### 6.69.3.13 void detect\_bb (cuc\_func \* func)

Here is the call graph for this function:

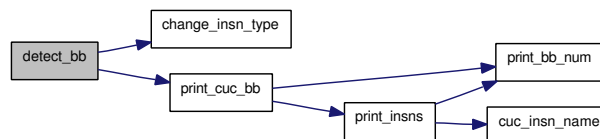

### 6.69.3.14 void detect\_max\_values (cuc\_func \* f)

Here is the call graph for this function:





**6.69.3.15** void dispose\_list (dep\_list \*\* list)

**6.69.3.16** cuc\_func\* dup\_func (cuc\_func \* f)

Here is the call graph for this function:

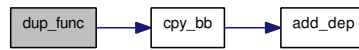

**6.69.3.17** void expand\_bb (cuc\_func \* f, int b)

Here is the call graph for this function:

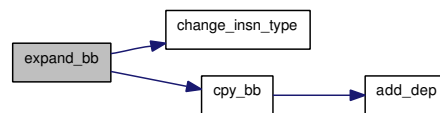

**6.69.3.18** void free\_func (cuc\_func \* f)

Here is the call graph for this function:



**6.69.3.19** void generate\_bb\_seq (cuc\_func \* f, char \* mp\_filename, char \* bb\_filename)

Here is the call graph for this function:



### 6.69.3.20 void insert\_conditional\_facts (cuc\_func \* func)

Here is the call graph for this function:

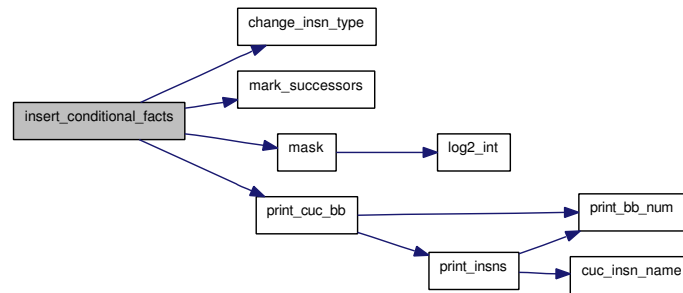

### 6.69.3.21 void insert\_insns (cuc\_func \* f, int ref, int n)

Here is the call graph for this function:

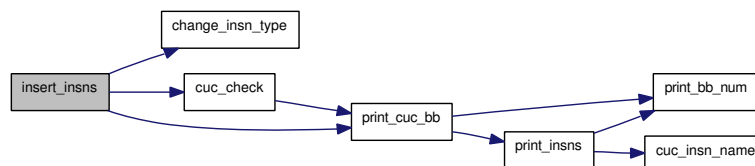



### 6.69.3.22 void main\_cuc (char \* filename)

Here is the call graph for this function:

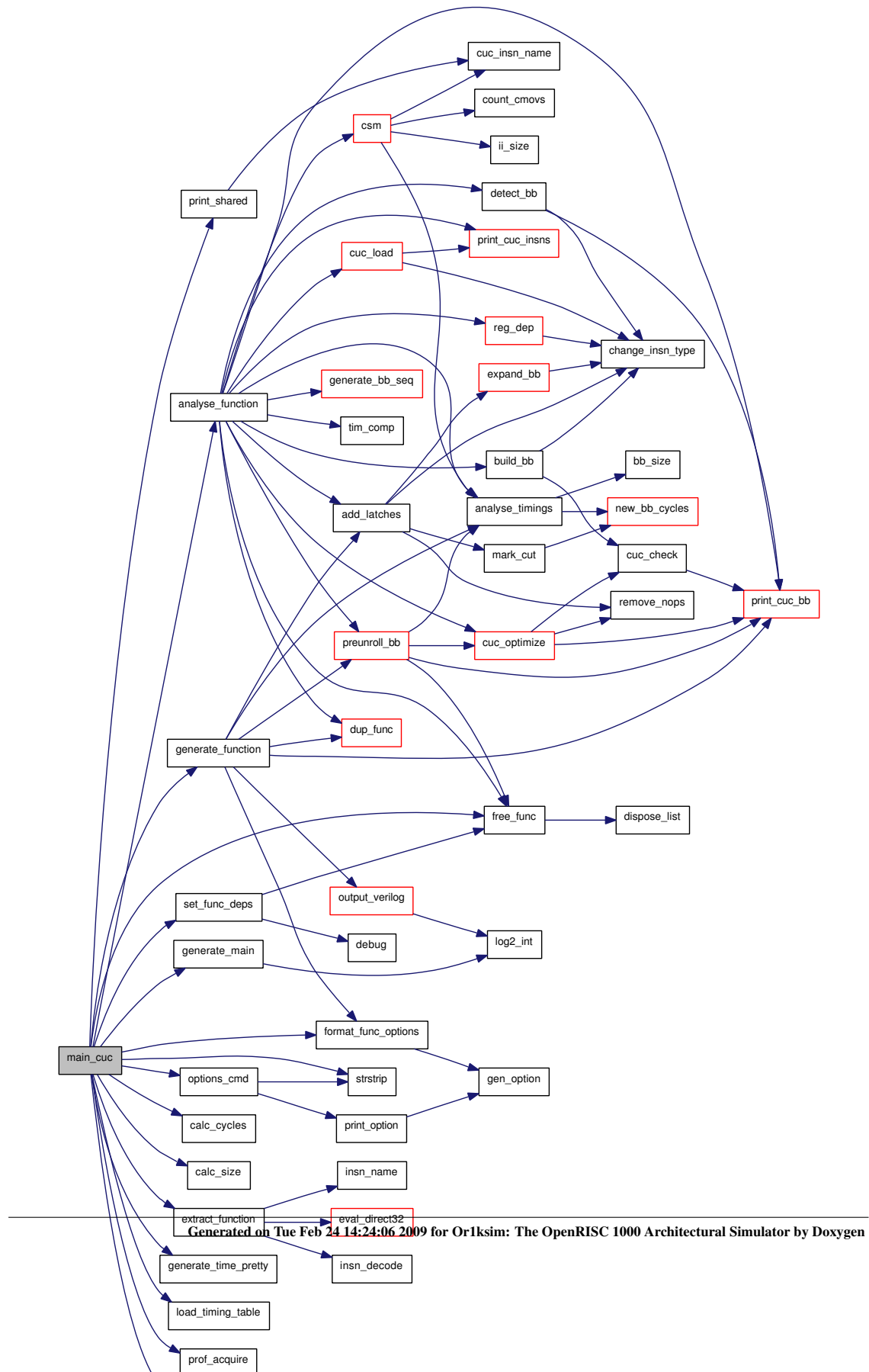

**6.69.3.23 void mark\_cut (cuc\_func \* f)**

Here is the call graph for this function:

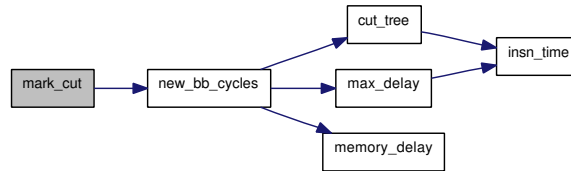
**6.69.3.24 void negate\_conditional (cuc\_insn \* ii)**

Here is the call graph for this function:

**6.69.3.25 int optimize\_bb (cuc\_func \* func)**

Here is the call graph for this function:

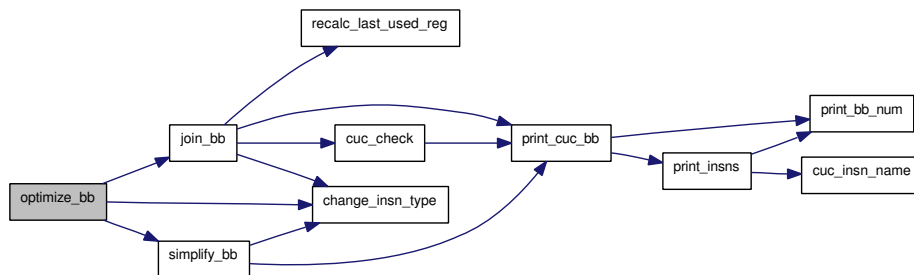
**6.69.3.26 int optimize\_cmovs (cuc\_func \* func)**

Here is the call graph for this function:

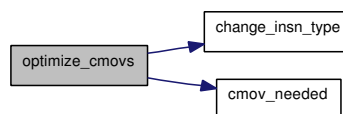

### 6.69.3.27 int optimize\_tree (cuc\_func \* func)

Here is the call graph for this function:

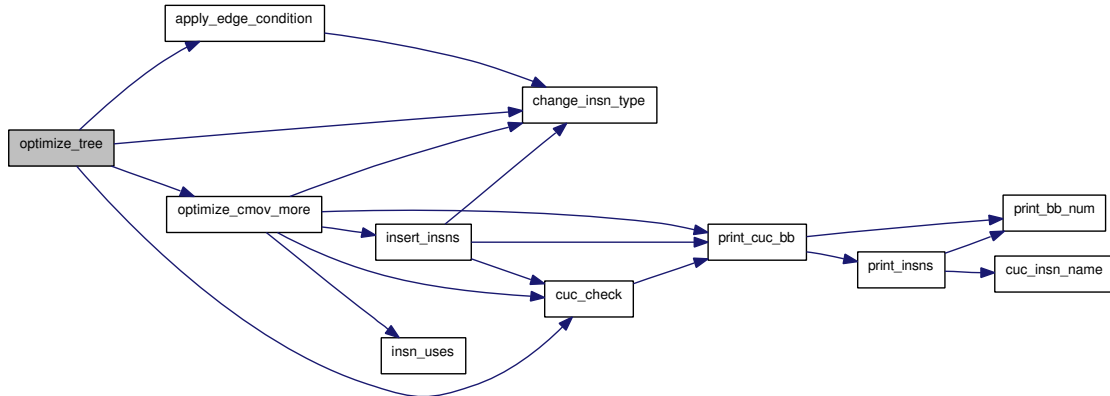

### 6.69.3.28 cuc\_func\* preunroll\_loop (cuc\_func \* func, int b, int preroll, int unroll, char \* bb\_filename)

Here is the call graph for this function:

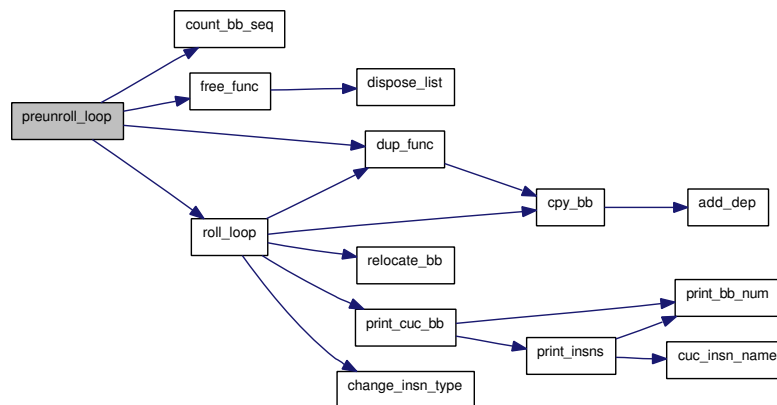

### 6.69.3.29 void print\_bb\_num (int num)

### 6.69.3.30 void print\_cuc\_bb (cuc\_func \* func, char \* s)

Here is the call graph for this function:

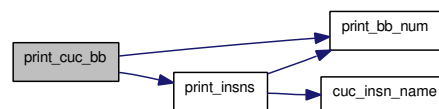

**6.69.3.31 void print\_cuc\_insns (char \* s, int verbose)**

Here is the call graph for this function:

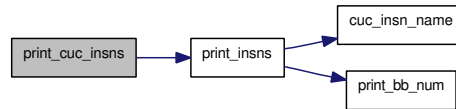
**6.69.3.32 void print\_insns (int bb, cuc\_insn \* insn, int size, int verbose)**

Here is the call graph for this function:

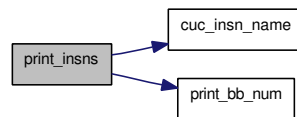
**6.69.3.33 void recalc\_cnts (cuc\_func \* f, char \* bb\_filename)****6.69.3.34 void reg\_cuc\_sec ()**

Here is the call graph for this function:

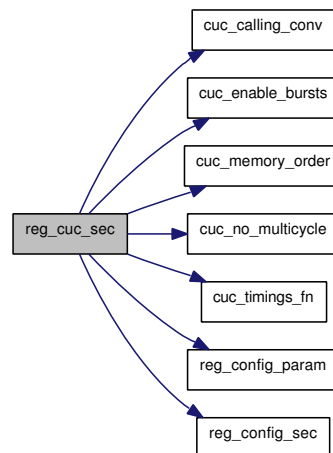

**6.69.3.35 void reg\_dep (cuc\_func \* *func*)**

Here is the call graph for this function:

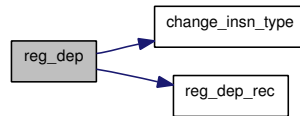
**6.69.3.36 int remove\_dead (cuc\_func \* *func*)**

Here is the call graph for this function:

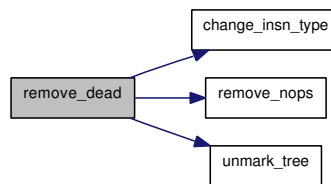
**6.69.3.37 int remove\_dead\_bb (cuc\_func \* *func*)****6.69.3.38 int remove\_nops (cuc\_func \* *func*)****6.69.3.39 int remove\_trivial\_regs (cuc\_func \* *f*)**

Here is the call graph for this function:

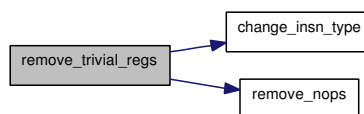



### 6.69.3.40 int schedule\_memory (cuc\_func \*func, int otype)

Here is the call graph for this function:

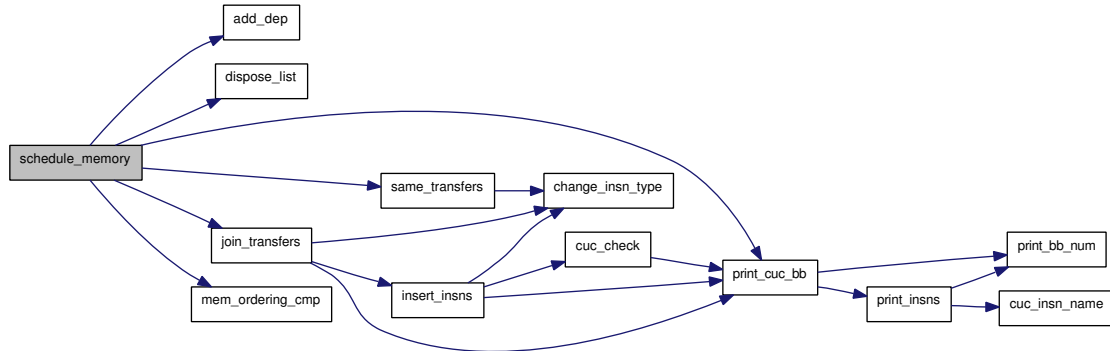

### 6.69.3.41 void set\_io (cuc\_func \*func)

Here is the call graph for this function:

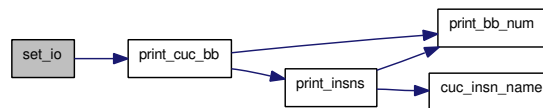

## 6.69.4 Variable Documentation

6.69.4.1 const int caller\_saved[MAX\_REGS]

6.69.4.2 int cuc\_debug

6.69.4.3 FILE\* flog

6.69.4.4 cuc\_insn insn[MAX\_INSNS]

6.69.4.5 int num\_insn

6.69.4.6 int reloc[MAX\_INSNS]

## 6.70 cuc/insn.c File Reference

```
#include "config.h"
#include <stdlib.h>
#include <assert.h>
#include "insn.h"
#include "sim-config.h"
```

Include dependency graph for insn.c:

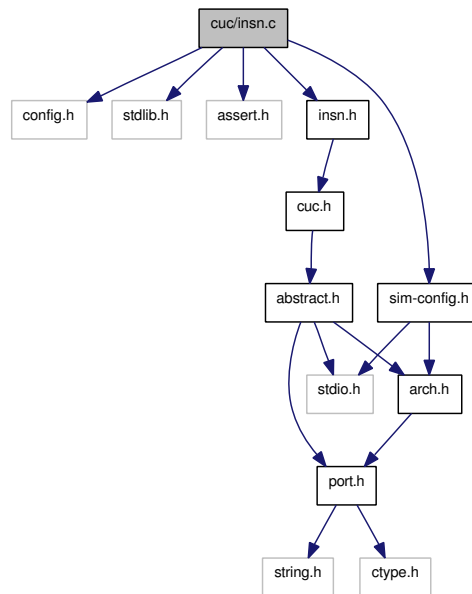

## Functions

- void [change\\_insn\\_type](#) (cuc\_insn \*i, int index)
- const char \* [cuc\\_insn\\_name](#) (cuc\_insn \*ii)
- void [print\\_insns](#) (int bb, cuc\_insn \*insn, int ninsn, int verbose)
- void [add\\_dep](#) (dep\_list \*\*list, int dep)
- void [dispose\\_list](#) (dep\_list \*\*list)
- void [add\\_data\\_dep](#) (cuc\_func \*f)
- void [insert\\_insns](#) (cuc\_func \*f, int ref, int n)
- int [apply\\_edge\\_condition](#) (cuc\_insn \*ii)
- static int [cmov\\_needed](#) (cuc\_func \*f, int ref)
- int [optimize\\_cmovs](#) (cuc\_func \*f)
- static int [insn\\_uses](#) (cuc\_func \*f, int ref)
- static int [optimize\\_cmov\\_more](#) (cuc\_func \*f, int ref)
- int [optimize\\_tree](#) (cuc\_func \*f)
- int [remove\\_nops](#) (cuc\_func \*f)
- static void [unmark\\_tree](#) (cuc\_func \*f, int ref)
- int [remove\\_dead](#) (cuc\_func \*f)
- int [remove\\_trivial\\_regs](#) (cuc\_func \*f)

- void `set_io` (`cuc_func` \*f)
- void `add_latches` (`cuc_func` \*f)
- int `cse` (`cuc_func` \*f)
- static int `count_cmovs` (`cuc_insn` \*ii, int match)
- static void `search_csm` (int iter, `cuc_func` \*f, `cuc_shared_list` \*list)
- void `csm` (`cuc_func` \*f)
- void `print_shared` (`cuc_func` \*rf, `cuc_shared_item` \*shared, int nshared)
- void `csm_gen` (`cuc_func` \*f, `cuc_func` \*rf, `cuc_shared_item` \*shared, int nshared)

## Variables

- const `cuc_known_insn` `known` [II\_LAST+1]
- static unsigned long `tmp_op`
- static unsigned long `tmp_opt`
- static `cuc_shared_list` \* `main_list`
- static int \* `iteration`

### 6.70.1 Function Documentation

#### 6.70.1.1 void `add_data_dep` (`cuc_func` \*f)

Here is the call graph for this function:



#### 6.70.1.2 void `add_dep` (`dep_list` \*\*list, int dep)

#### 6.70.1.3 void `add_latches` (`cuc_func` \*f)

Here is the call graph for this function:

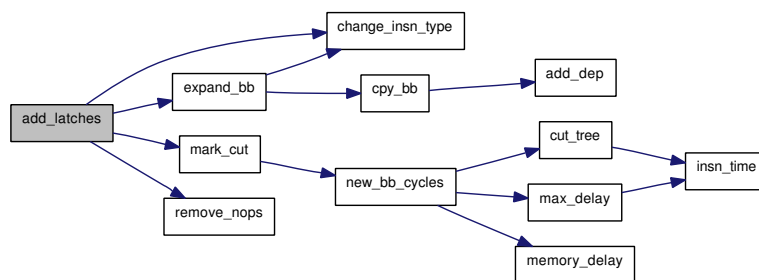

#### 6.70.1.4 int apply\_edge\_condition (cuc\_insn \* ii)

Here is the call graph for this function:

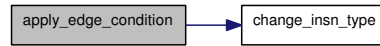

#### 6.70.1.5 void change\_insn\_type (cuc\_insn \* i, int index)

#### 6.70.1.6 static int cmov\_needed (cuc\_func \* f, int ref) [static]

#### 6.70.1.7 static int count\_cmovs (cuc\_insn \* ii, int match) [static]

#### 6.70.1.8 int cse (cuc\_func \* f)

Here is the call graph for this function:



#### 6.70.1.9 void csm (cuc\_func \* f)

Here is the call graph for this function:

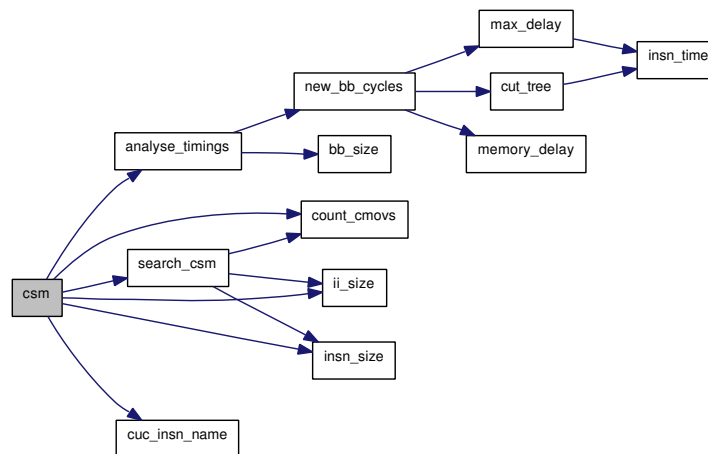

#### 6.70.1.10 void csm\_gen (cuc\_func \* f, cuc\_func \* rf, cuc\_shared\_item \* shared, int nshared)

Here is the call graph for this function:

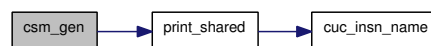

**6.70.1.11** `const char* cuc_insn_name (cuc_insn * ii)`

**6.70.1.12** `void dispose_list (dep_list ** list)`

**6.70.1.13** `void insert_insns (cuc_func * f, int ref, int n)`

Here is the call graph for this function:

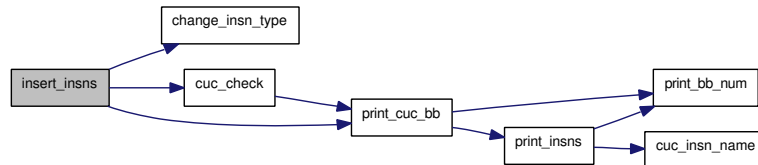

**6.70.1.14** `static int insn_uses (cuc_func * f, int ref)` [static]

**6.70.1.15** `static int optimize_cmov_more (cuc_func * f, int ref)` [static]

Here is the call graph for this function:

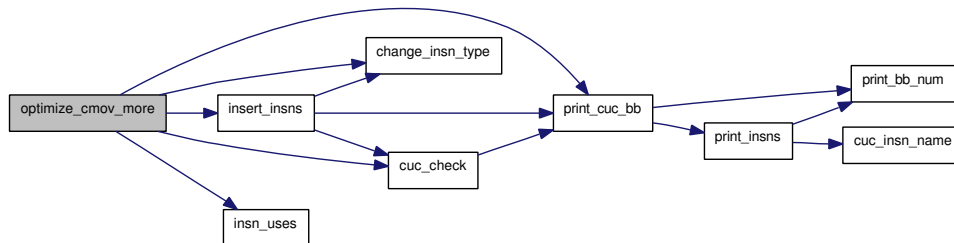

**6.70.1.16** `int optimize_cmovs (cuc_func * f)`

Here is the call graph for this function:

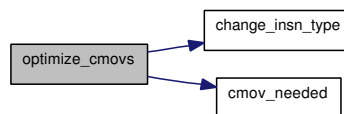

### 6.70.1.17 int optimize\_tree (cuc\_func \* f)

Here is the call graph for this function:

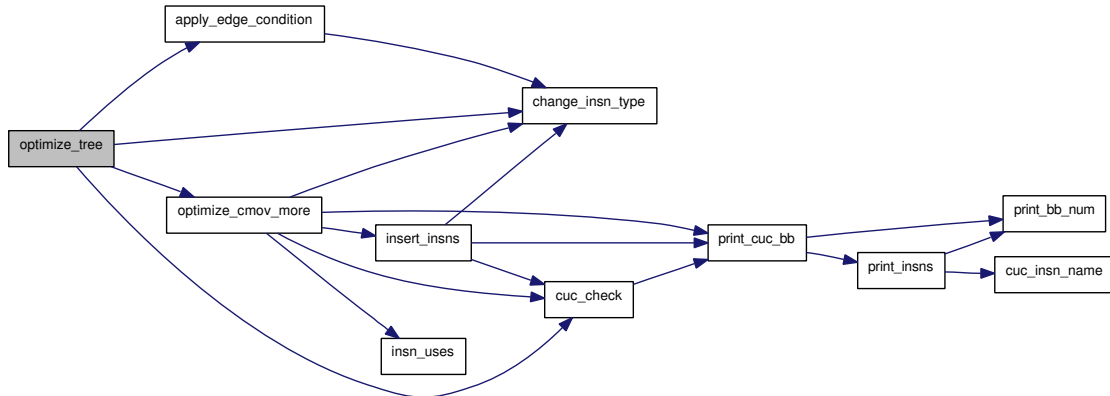

### 6.70.1.18 void print\_insns (int bb, cuc\_insn \* insn, int ninsn, int verbose)

Here is the call graph for this function:

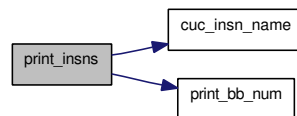

### 6.70.1.19 void print\_shared (cuc\_func \* rf, cuc\_shared\_item \* shared, int nshared)

Here is the call graph for this function:



### 6.70.1.20 int remove\_dead (cuc\_func \* f)

Here is the call graph for this function:

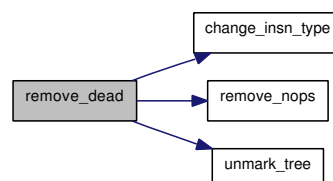

**6.70.1.21** `int remove_nops (cuc_func *f)`

**6.70.1.22** `int remove_trivial_regs (cuc_func *f)`

Here is the call graph for this function:

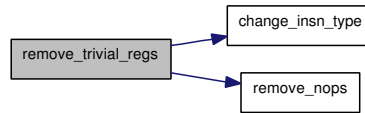

**6.70.1.23** `static void search_csm (int iter, cuc_func *f, cuc_shared_list *list)` [static]

Here is the call graph for this function:

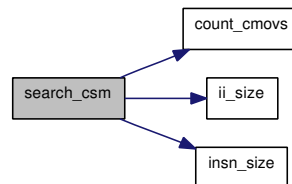

**6.70.1.24** `void set_io (cuc_func *f)`

Here is the call graph for this function:

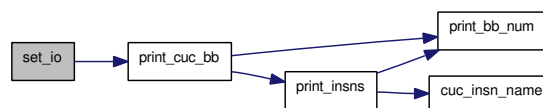

**6.70.1.25** `static void unmark_tree (cuc_func *f, int ref)` [static]

## 6.70.2 Variable Documentation

**6.70.2.1** `int* iteration` [static]

**6.70.2.2** `const cuc_known_insn known[II_LAST+1]`

**6.70.2.3** `cuc_shared_list* main_list` [static]

**6.70.2.4** `unsigned long tmp_op` [static]

**6.70.2.5** `unsigned long tmp_opt` [static]

## 6.71 cuc/insn.h File Reference

```
#include "cuc.h"
```

Include dependency graph for insn.h:

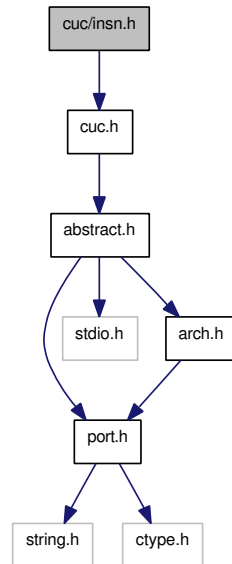

This graph shows which files directly or indirectly include this file:

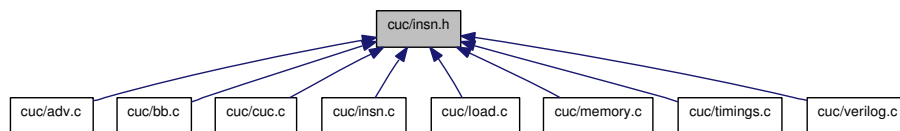

### Data Structures

- struct [cuc\\_known\\_insn](#)
- struct [cuc\\_timing\\_table](#)
- struct [cuc\\_conv](#)

### Defines

- #define [II\\_ADD](#) 0
- #define [II\\_SUB](#) 1
- #define [II\\_AND](#) 2
- #define [II\\_OR](#) 3
- #define [II\\_XOR](#) 4
- #define [II\\_MUL](#) 5
- #define [II\\_SRL](#) 6
- #define [II\\_SLL](#) 7
- #define [II\\_SRA](#) 8



- #define [II\\_LB](#) 9
- #define [II\\_LH](#) 10
- #define [II\\_LW](#) 11
- #define [II\\_SB](#) 12
- #define [II\\_SH](#) 13
- #define [II\\_SW](#) 14
- #define [II\\_SFEQ](#) 15
- #define [II\\_SFNE](#) 16
- #define [II\\_SFLE](#) 17
- #define [II\\_SFLT](#) 18
- #define [II\\_SFGE](#) 19
- #define [II\\_SFGT](#) 20
- #define [II\\_BF](#) 21
- #define [II\\_LRBB](#) 22
- #define [II\\_CMOV](#) 23
- #define [II\\_REG](#) 24
- #define [II\\_NOP](#) 25
- #define [II\\_CALL](#) 26
- #define [II\\_LAST](#) 26
- #define [II\\_MASK](#) 0x0fff
- #define [II\\_MEM](#) 0x1000
- #define [II\\_SIGNED](#) 0x2000
- #define [II\\_IS\\_LOAD](#)(x) ((x) == II\_LB || (x) == II\_LH || (x) == II\_LW)
- #define [II\\_IS\\_STORE](#)(x) ((x) == II\_SB || (x) == II\_SH || (x) == II\_SW)
- #define [II\\_MEM\\_WIDTH](#)(x)

## Functions

- double [ii\\_size](#) (int index, int imm)
- double [insn\\_time](#) (cuc\_insn \*ii)
- double [insn\\_size](#) (cuc\_insn \*ii)
- void [change\\_insn\\_type](#) (cuc\_insn \*i, int index)
- const char \* [cuc\\_insn\\_name](#) (cuc\_insn \*ii)
- void [load\\_timing\\_table](#) (char \*filename)
- void [print\\_shared](#) (cuc\_func \*rf, cuc\_shared\_item \*shared, int nshared)

## Variables

- const [cuc\\_known\\_insn](#) known [II\_LAST+1]

## 6.71.1 Define Documentation

6.71.1.1 **#define II\_ADD 0**

6.71.1.2 **#define II\_AND 2**

6.71.1.3 **#define II\_BF 21**

6.71.1.4 **#define II\_CALL 26**

6.71.1.5 **#define II\_CMOV 23**

6.71.1.6 **#define II\_IS\_LOAD(x) ((x) == II\_LB || (x) == II\_LH || (x) == II\_LW)**

6.71.1.7 **#define II\_IS\_STORE(x) ((x) == II\_SB || (x) == II\_SH || (x) == II\_SW)**

6.71.1.8 **#define II\_LAST 26**

6.71.1.9 **#define II\_LB 9**

6.71.1.10 **#define II\_LH 10**

6.71.1.11 **#define II\_LRBB 22**

6.71.1.12 **#define II\_LW 11**

6.71.1.13 **#define II\_MASK 0x0fff**

6.71.1.14 **#define II\_MEM 0x1000**

6.71.1.15 **#define II\_MEM\_WIDTH(x)**

**Value:**

```
((x) == II_LB || (x) == II_SB) ? 1 : \  
    ((x) == II_LH || (x) == II_SH) ? 2 : \  
    ((x) == II_LW || (x) == II_SW) ? 4 : -1
```



6.71.1.16 `#define II_MUL 5`

6.71.1.17 `#define II_NOP 25`

6.71.1.18 `#define II_OR 3`

6.71.1.19 `#define II_REG 24`

6.71.1.20 `#define II_SB 12`

6.71.1.21 `#define II_SFEQ 15`

6.71.1.22 `#define II_SFGE 19`

6.71.1.23 `#define II_SFGT 20`

6.71.1.24 `#define II_SFLE 17`

6.71.1.25 `#define II_SFLT 18`

6.71.1.26 `#define II_SFNE 16`

6.71.1.27 `#define II_SH 13`

6.71.1.28 `#define II_SIGNED 0x2000`

6.71.1.29 `#define II_SLL 7`

6.71.1.30 `#define II_SRA 8`

6.71.1.31 `#define II_SRL 6`

6.71.1.32 `#define II_SUB 1`

6.71.1.33 `#define II_SW 14`

6.71.1.34 `#define II_XOR 4`

## 6.71.2 Function Documentation

6.71.2.1 `void change_insn_type (cuc_insn * i, int index)`

6.71.2.2 `const char* cuc_insn_name (cuc_insn * ii)`

6.71.2.3 `double ii_size (int index, int imm)`

6.71.2.4 `double insn_size (cuc_insn * ii)`

6.71.2.5 `double insn_time (cuc_insn * ii)`

6.71.2.6 `void load_timing_table (char * filename)`

6.71.2.7 `void print_shared (cuc_func * rf, cuc_shared_item * shared, int nshared)`

Here is the call graph for this function: Generated on 24 14:24:06 2009 for Or1ksim: The OpenRISC 1000 Architectural Simulator by Doxygen



### 6.71.3 Variable Documentation

#### 6.71.3.1 `const cuc_known_insn known[II_LAST+1]`

## 6.72 cuc/load.c File Reference

```
#include <stdio.h>
#include <stdlib.h>
#include <stdarg.h>
#include <assert.h>
#include "config.h"
#include "port.h"
#include "arch.h"
#include "abstract.h"
#include "sim-config.h"
#include "cuc.h"
#include "opcode/or32.h"
#include "insn.h"
```

Include dependency graph for load.c:

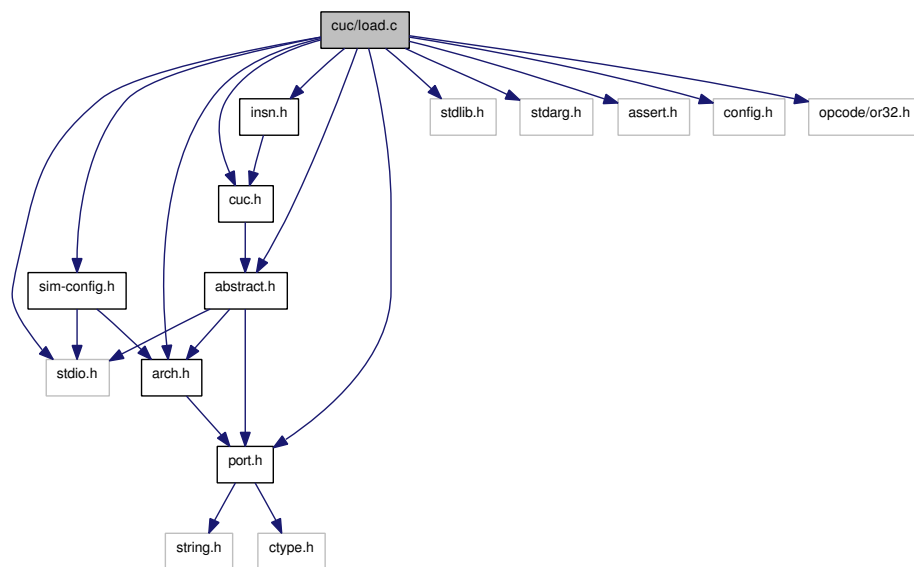

## Functions

- void [print\\_cuc\\_insns](#) (char \*s, int verbose)
- void [xchg\\_insn](#) (int i, int j)
- void [negate\\_conditional](#) (cuc\_insn \*ii)
- void [remove\\_dslots](#) ()
- void [detect\\_locals](#) ()
- const char \* [build\\_insn](#) (unsigned long data, cuc\_insn \*insn)
- void [expand\\_branch](#) ()
- void [expand\\_memory](#) ()

- void [expand\\_signed](#) ()
- void [expand\\_calls](#) ()
- int [cuc\\_load](#) (char \*in\_fn)

## Variables

- static const [cuc\\_conv](#) conv []
- [cuc\\_insn](#) insn [MAX\_INSNS]
- int [num\\_insn](#)
- int [reloc](#) [MAX\_INSNS]

### 6.72.1 Function Documentation

#### 6.72.1.1 const char\* [build\\_insn](#) (unsigned long *data*, cuc\_insn \* *insn*)

Here is the call graph for this function:

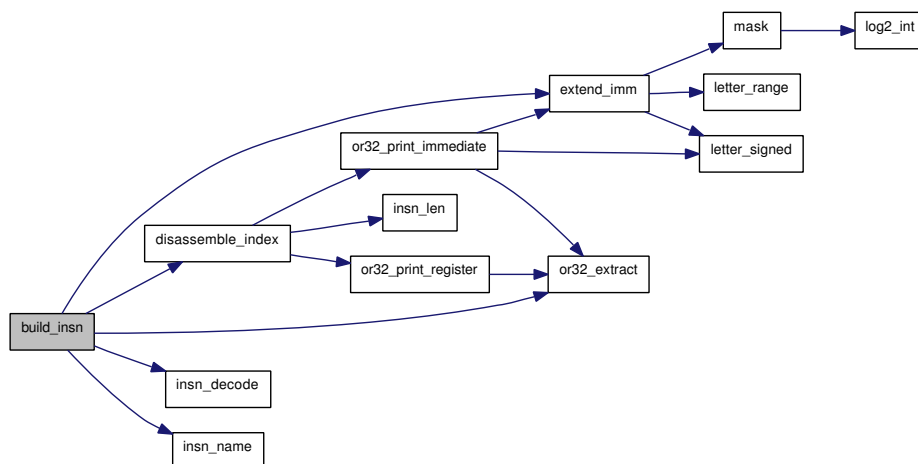

### 6.72.1.2 int cuc\_load (char \* in\_fn)

Here is the call graph for this function:

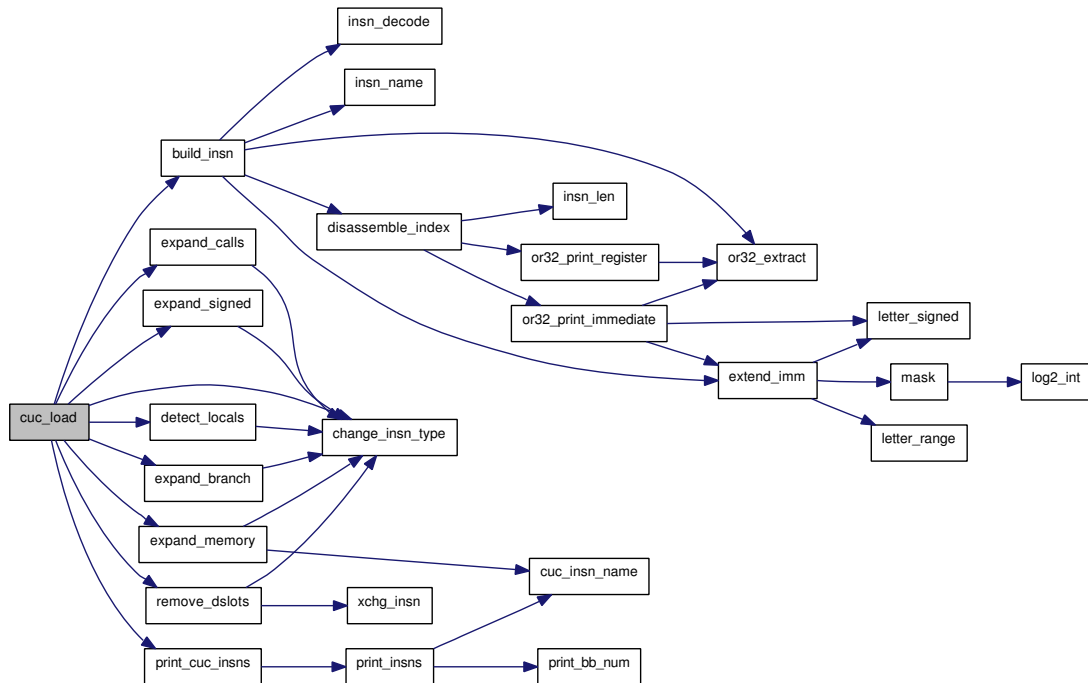

### 6.72.1.3 void detect\_locals ()

Here is the call graph for this function:



### 6.72.1.4 void expand\_branch ()

Here is the call graph for this function:



### 6.72.1.5 void expand\_calls ()

Here is the call graph for this function:





### 6.72.1.6 void expand\_memory ()

Here is the call graph for this function:

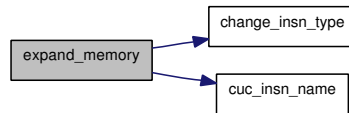

### 6.72.1.7 void expand\_signed ()

Here is the call graph for this function:



### 6.72.1.8 void negate\_conditional (cuc\_insn \* ii)

Here is the call graph for this function:



### 6.72.1.9 void print\_cuc\_insns (char \* s, int verbose)

Here is the call graph for this function:

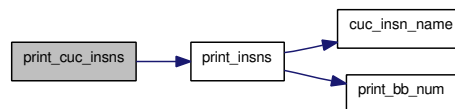

### 6.72.1.10 void remove\_dslots ()

Here is the call graph for this function:

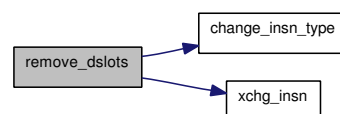

**6.72.1.11** void xchg\_insn (int *i*, int *j*)

## **6.72.2 Variable Documentation**

**6.72.2.1** const cuc\_conv conv[] [static]

**6.72.2.2** cuc\_insn insn[MAX\_INSNS]

**6.72.2.3** int num\_insn

**6.72.2.4** int reloc[MAX\_INSNS]

## 6.73 cuc/memory.c File Reference

```
#include <stdio.h>
#include <stdlib.h>
#include <stdarg.h>
#include <assert.h>
#include "config.h"
#include "port.h"
#include "arch.h"
#include "abstract.h"
#include "sim-config.h"
#include "cuc.h"
#include "insn.h"
```

Include dependency graph for memory.c:

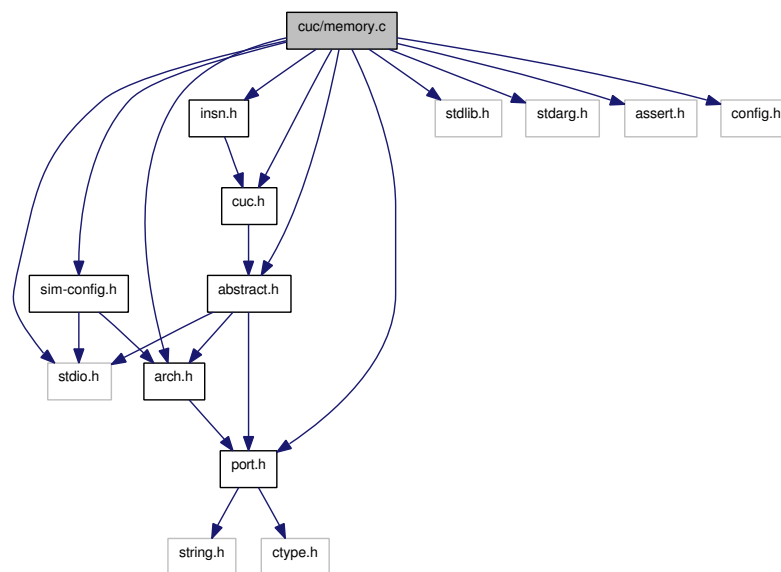

## Functions

- void `clean_deps` (`cuc_func *f`)
- static int `check_memory_conflict` (`cuc_func *f`, `cuc_insn *a`, `cuc_insn *b`, int otype)
- void `add_memory_dep` (`cuc_func *f`, int otype)
- static int `same_transfers` (`cuc_func *f`, int otype)
- static int `join_transfers` (`cuc_func *f`, int otype)
- int `mem_ordering_cmp` (`cuc_func *f`, `cuc_insn *a`, `cuc_insn *b`)
- int `schedule_memory` (`cuc_func *f`, int otype)

## 6.73.1 Function Documentation

### 6.73.1.1 void add\_memory\_dep (cuc\_func \*f, int otype)

Here is the call graph for this function:

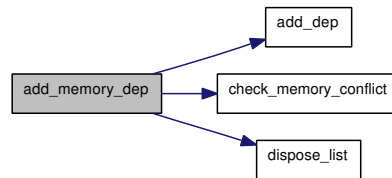

### 6.73.1.2 static int check\_memory\_conflict (cuc\_func \*f, cuc\_insn \*a, cuc\_insn \*b, int otype) [static]

### 6.73.1.3 void clean\_deps (cuc\_func \*f)

### 6.73.1.4 static int join\_transfers (cuc\_func \*f, int otype) [static]

Here is the call graph for this function:

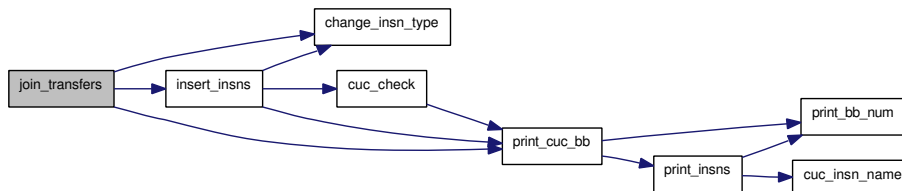

### 6.73.1.5 int mem\_ordering\_cmp (cuc\_func \*f, cuc\_insn \*a, cuc\_insn \*b)

### 6.73.1.6 static int same\_transfers (cuc\_func \*f, int otype) [static]

Here is the call graph for this function:



**6.73.1.7** `int schedule_memory (cuc_func *f, int otype)`

Here is the call graph for this function:

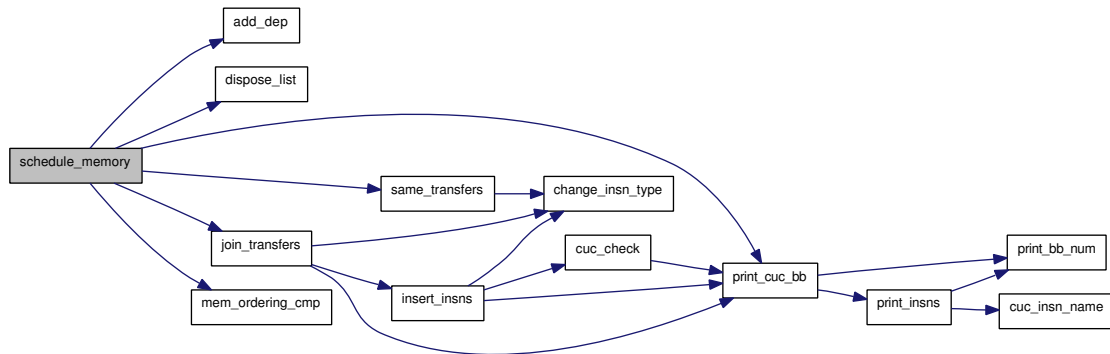

## 6.74 peripheral/memory.c File Reference

```
#include "config.h"
#include "port.h"
#include <stdlib.h>
#include <stdio.h>
#include <time.h>
#include "arch.h"
#include "sim-config.h"
#include "abstract.h"
#include "mc.h"
#include "toplevel-support.h"
```

Include dependency graph for memory.c:

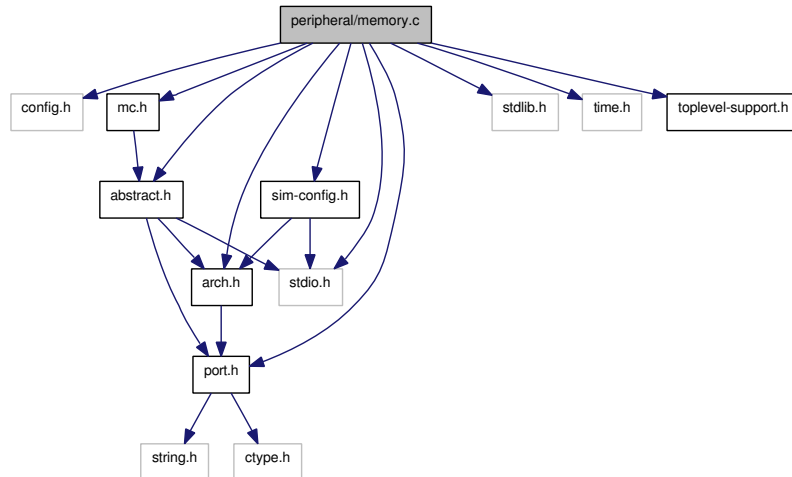

### Data Structures

- struct [mem\\_config](#)

### Functions

- static uint32\_t [simmem\\_read32](#) (oraddr\_t addr, void \*dat)
- static uint16\_t [simmem\\_read16](#) (oraddr\_t addr, void \*dat)
- static uint8\_t [simmem\\_read8](#) (oraddr\_t addr, void \*dat)
- static void [simmem\\_write32](#) (oraddr\_t addr, uint32\_t value, void \*dat)
- static void [simmem\\_write16](#) (oraddr\_t addr, uint16\_t value, void \*dat)
- static void [simmem\\_write8](#) (oraddr\_t addr, uint8\_t value, void \*dat)
- static uint32\_t [simmem\\_read\\_zero32](#) (oraddr\_t addr, void \*dat)
- static uint16\_t [simmem\\_read\\_zero16](#) (oraddr\_t addr, void \*dat)
- static uint8\_t [simmem\\_read\\_zero8](#) (oraddr\_t addr, void \*dat)

- static void `simmem_write_null32` (`oraddr_t` `addr`, `uint32_t` `value`, `void *dat`)
- static void `simmem_write_null16` (`oraddr_t` `addr`, `uint16_t` `value`, `void *dat`)
- static void `simmem_write_null8` (`oraddr_t` `addr`, `uint8_t` `value`, `void *dat`)
- static void `mem_reset` (`void *dat`)
- static void `memory_random_seed` (`union param_val` `val`, `void *dat`)
- static void `memory_pattern` (`union param_val` `val`, `void *dat`)
- static void `memory_type` (`union param_val` `val`, `void *dat`)
- static void `memory_ce` (`union param_val` `val`, `void *dat`)
- static void `memory_mc` (`union param_val` `val`, `void *dat`)
- static void `memory_baseaddr` (`union param_val` `val`, `void *dat`)
- static void `memory_size` (`union param_val` `val`, `void *dat`)
- static void `memory_name` (`union param_val` `val`, `void *dat`)
- static void `memory_log` (`union param_val` `val`, `void *dat`)
- static void `memory_delayr` (`union param_val` `val`, `void *dat`)
- static void `memory_delayw` (`union param_val` `val`, `void *dat`)
- static void \* `memory_sec_start` ()
- static void `memory_sec_end` (`void *dat`)
- void `reg_memory_sec` (`void`)

### 6.74.1 Function Documentation

**6.74.1.1** static void `mem_reset` (`void * dat`) [static]

**6.74.1.2** static void `memory_baseaddr` (`union param_val val`, `void * dat`) [static]

**6.74.1.3** static void `memory_ce` (`union param_val val`, `void * dat`) [static]

**6.74.1.4** static void `memory_delayr` (`union param_val val`, `void * dat`) [static]

**6.74.1.5** static void `memory_delayw` (`union param_val val`, `void * dat`) [static]

**6.74.1.6** static void `memory_log` (`union param_val val`, `void * dat`) [static]

**6.74.1.7** static void `memory_mc` (`union param_val val`, `void * dat`) [static]

**6.74.1.8** static void `memory_name` (`union param_val val`, `void * dat`) [static]

**6.74.1.9** static void `memory_pattern` (`union param_val val`, `void * dat`) [static]

Set the memory pattern

Value must be up to 8 bits. Larger values are truncated with a warning.

#### Parameters:

← *val* The value to use

← *dat* The `config` data structure

**6.74.1.10** `static void memory_random_seed (union param_val val, void * dat)` [static]

**6.74.1.11** `static void memory_sec_end (void * dat)` [static]

Here is the call graph for this function:

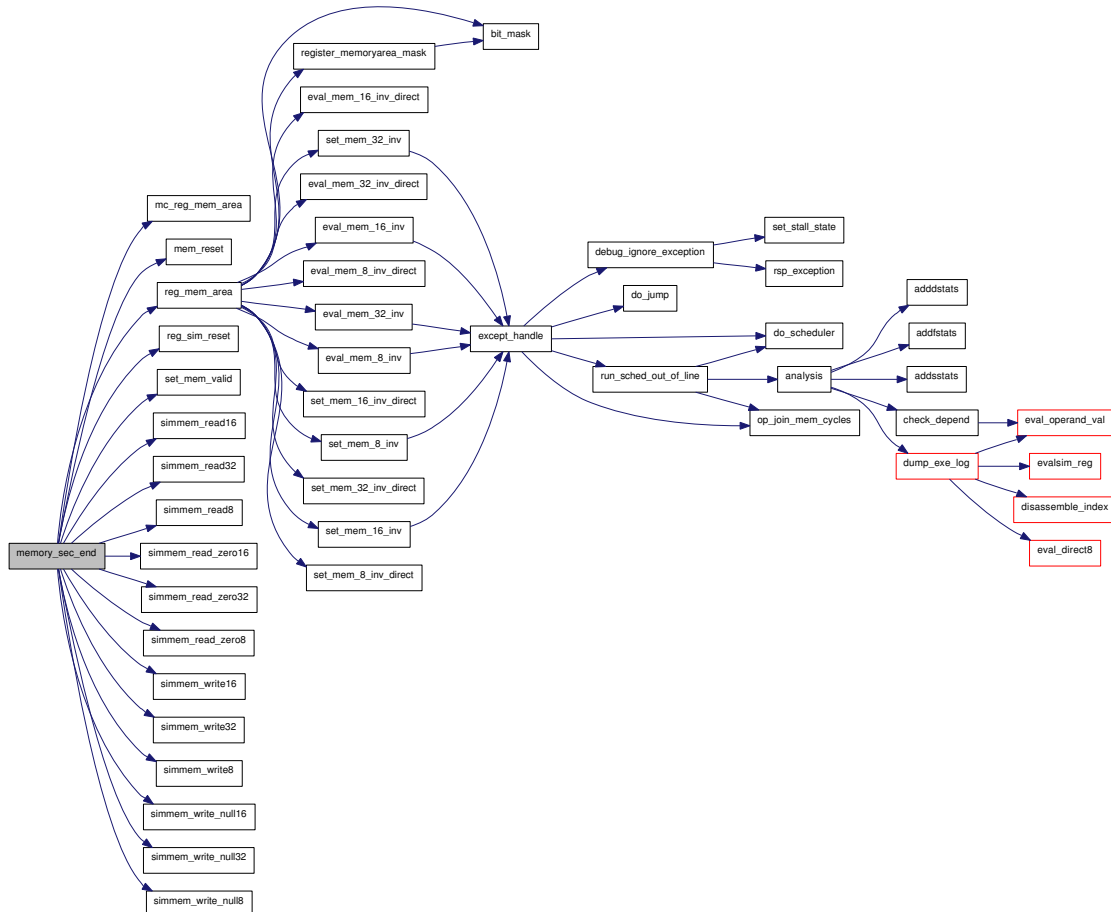

**6.74.1.12** `static void* memory_sec_start ()` [static]

Initialize a new block of memory configuration

ALL parameters are set explicitly to default values.

**Returns:**

The new memory configuration data structure

**6.74.1.13** `static void memory_size (union param_val val, void * dat)` [static]

**6.74.1.14** `static void memory_type (union param_val val, void * dat)` [static]

Set the memory type



Value must be one of unknown, random, pattern or zero (case insensitive). Unrecognized values are ignored with a warning.

#### Parameters:

- ← *val* The value to use
- ← *dat* The `config` data structure

#### 6.74.1.15 void reg\_memory\_sec (void)

Here is the call graph for this function:

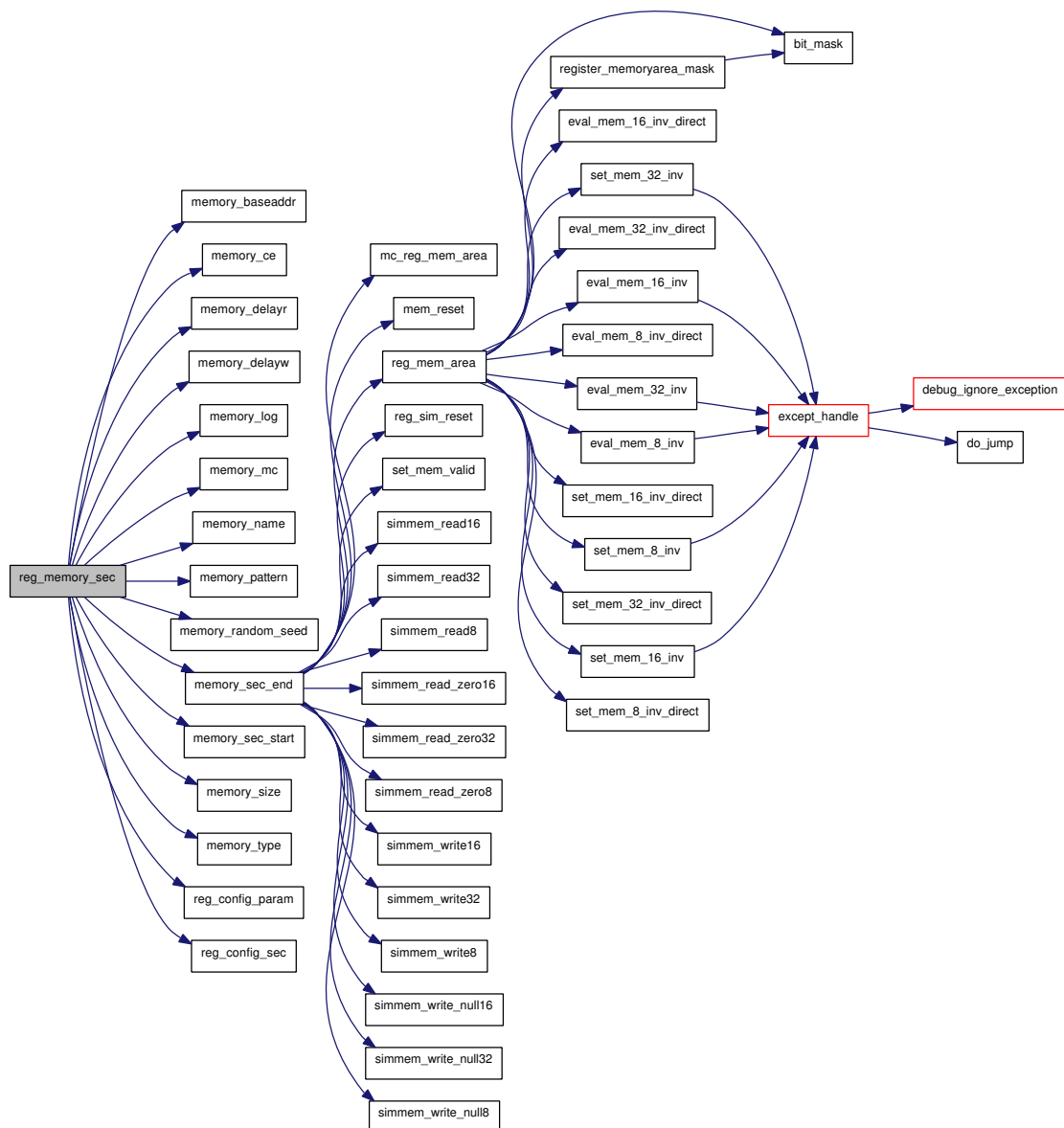

- 6.74.1.16 `static uint16_t simmem_read16 (oraddr_t addr, void * dat) [static]`
- 6.74.1.17 `static uint32_t simmem_read32 (oraddr_t addr, void * dat) [static]`
- 6.74.1.18 `static uint8_t simmem_read8 (oraddr_t addr, void * dat) [static]`
- 6.74.1.19 `static uint16_t simmem_read_zero16 (oraddr_t addr, void * dat) [static]`
- 6.74.1.20 `static uint32_t simmem_read_zero32 (oraddr_t addr, void * dat) [static]`
- 6.74.1.21 `static uint8_t simmem_read_zero8 (oraddr_t addr, void * dat) [static]`
- 6.74.1.22 `static void simmem_write16 (oraddr_t addr, uint16_t value, void * dat) [static]`
- 6.74.1.23 `static void simmem_write32 (oraddr_t addr, uint32_t value, void * dat) [static]`
- 6.74.1.24 `static void simmem_write8 (oraddr_t addr, uint8_t value, void * dat) [static]`
- 6.74.1.25 `static void simmem_write_null16 (oraddr_t addr, uint16_t value, void * dat)  
[static]`
- 6.74.1.26 `static void simmem_write_null32 (oraddr_t addr, uint32_t value, void * dat)  
[static]`
- 6.74.1.27 `static void simmem_write_null8 (oraddr_t addr, uint8_t value, void * dat) [static]`

## 6.75 cuc/timings.c File Reference

```
#include <stdio.h>
#include <stdlib.h>
#include <stdarg.h>
#include <assert.h>
#include <math.h>
#include "config.h"
#include "port.h"
#include "arch.h"
#include "abstract.h"
#include "sim-config.h"
#include "cuc.h"
#include "insn.h"
```

Include dependency graph for timings.c:

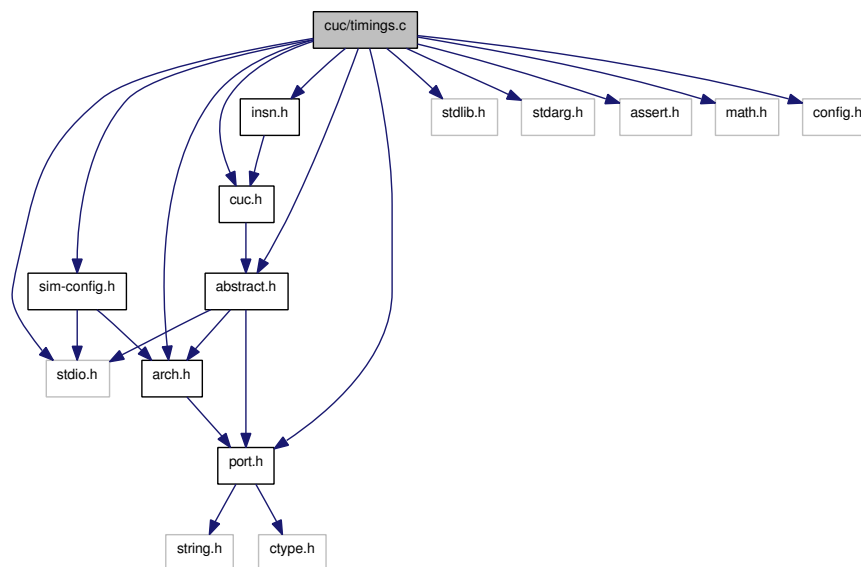

## Functions

- double [insn\\_time](#) ([cuc\\_insn](#) \*ii)
- double [insn\\_size](#) ([cuc\\_insn](#) \*ii)
- double [ii\\_size](#) (int index, int imm)
- static double [max\\_delay](#) ([cuc\\_func](#) \*f, int b)
- static int [memory\\_delay](#) ([cuc\\_func](#) \*f, int b)
- void [cut\\_tree](#) ([cuc\\_func](#) \*f, int b, double sd)
- static int [new\\_bb\\_cycles](#) ([cuc\\_func](#) \*f, int b, int cut)
- void [mark\\_cut](#) ([cuc\\_func](#) \*f)

- static double `bb_size` (`cuc_bb *bb`)
- void `recalc_cnts` (`cuc_func *f`, `char *bb_filename`)
- void `analyse_timings` (`cuc_func *f`, `cuc_timings *timings`)
- void `load_timing_table` (`char *filename`)

## Variables

- static `cuc_timing_table * timing_table`
- static double `max_bb_delay`

## 6.75.1 Function Documentation

### 6.75.1.1 void `analyse_timings` (`cuc_func *f`, `cuc_timings *timings`)

Here is the call graph for this function:

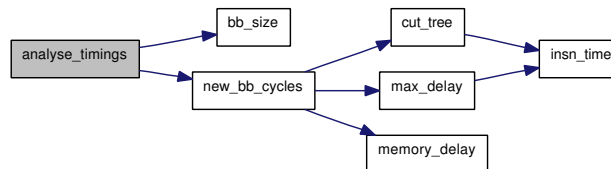

### 6.75.1.2 static double `bb_size` (`cuc_bb *bb`) [static]

### 6.75.1.3 void `cut_tree` (`cuc_func *f`, `int b`, `double sd`)

Here is the call graph for this function:



**6.75.1.4** `double ii_size (int index, int imm)`

**6.75.1.5** `double insn_size (cuc_insn * ii)`

**6.75.1.6** `double insn_time (cuc_insn * ii)`

**6.75.1.7** `void load_timing_table (char * filename)`

**6.75.1.8** `void mark_cut (cuc_func * f)`

Here is the call graph for this function:

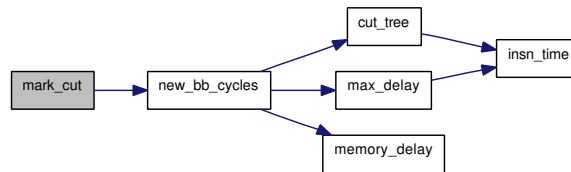

**6.75.1.9** `static double max_delay (cuc_func * f, int b)` `[static]`

Here is the call graph for this function:



**6.75.1.10** `static int memory_delay (cuc_func * f, int b)` `[static]`

**6.75.1.11** `static int new_bb_cycles (cuc_func * f, int b, int cut)` `[static]`

Here is the call graph for this function:

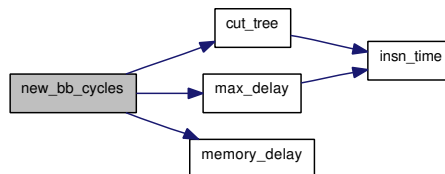

**6.75.1.12** `void recalc_cnts (cuc_func * f, char * bb_filename)`

## 6.75.2 Variable Documentation

**6.75.2.1** `double max_bb_delay` `[static]`

**6.75.2.2** `cuc_timing_table* timing_table` `[static]`

## 6.76 cuc/verilog.c File Reference

```
#include "config.h"
#include "port.h"
#include <stdio.h>
#include <stdlib.h>
#include <stdarg.h>
#include <assert.h>
#include "arch.h"
#include "abstract.h"
#include "cuc.h"
#include "insn.h"
#include "profiler.h"
#include "sim-config.h"
#include "misc.h"
```

Include dependency graph for verilog.c:

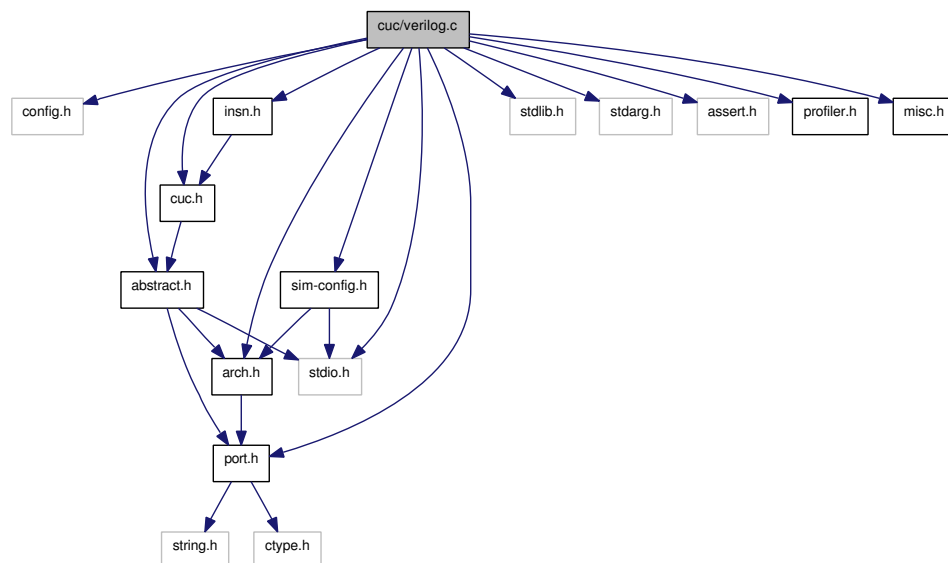

### Defines

- #define [GEN\(x...\)](#) fprintf (fo, x)

### Functions

- static int [find\\_lsc\\_index](#) (cuc\_func \*f, int ref)
- static void [print\\_deps](#) (FILE \*fo, cuc\_func \*f, int b, dep\_list \*t, int registered)
- static char \* [print\\_op\\_v](#) (cuc\_func \*f, char \*s, int ref, int j)

- static void `print_insn_v` (FILE \*fo, cuc\_func \*f, int b, int i)
- static int `branch_index` (cuc\_bb \*bb)
- static void `print_turn_off_dep` (FILE \*fo, cuc\_func \*f, dep\_list \*dep)
- static int `func_index` (cuc\_func \*f, int ref)
- void `output_verilog` (cuc\_func \*f, char \*filename, char \*funcname)
- void `generate_main` (int nfuncs, cuc\_func \*\*f, char \*filename)

## 6.76.1 Define Documentation

6.76.1.1 `#define GEN(x...) fprintf (fo, x)`

## 6.76.2 Function Documentation

6.76.2.1 static int `branch_index` (cuc\_bb \*bb) [static]

6.76.2.2 static int `find_lsc_index` (cuc\_func \*f, int ref) [static]

6.76.2.3 static int `func_index` (cuc\_func \*f, int ref) [static]

6.76.2.4 void `generate_main` (int nfuncs, cuc\_func \*\*f, char \*filename)

Here is the call graph for this function:



6.76.2.5 void `output_verilog` (cuc\_func \*f, char \*filename, char \*funcname)

Here is the call graph for this function:

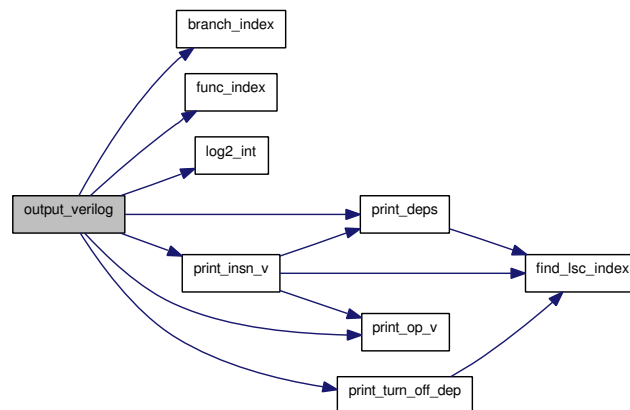

**6.76.2.6** `static void print_deps (FILE *fo, cuc_func *f, int b, dep_list *t, int registered)`  
[static]

Here is the call graph for this function:



**6.76.2.7** `static void print_insn_v (FILE *fo, cuc_func *f, int b, int i)` [static]

Here is the call graph for this function:

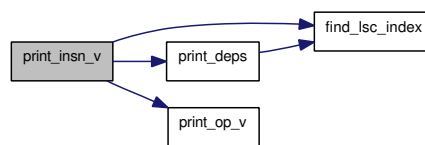

**6.76.2.8** `static char* print_op_v (cuc_func *f, char *s, int ref, int j)` [static]

**6.76.2.9** `static void print_turn_off_dep (FILE *fo, cuc_func *f, dep_list *dep)` [static]

Here is the call graph for this function:





## 6.77 cuc/verilog.h File Reference

This graph shows which files directly or indirectly include this file:

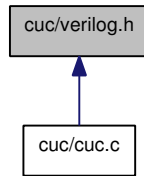

### Functions

- void [output\\_verilog](#) ([cuc\\_func](#) \*func, char \*filename, char \*funcname)
- void [generate\\_main](#) (int nfuncs, [cuc\\_func](#) \*\*f, char \*filename)

#### 6.77.1 Function Documentation

##### 6.77.1.1 void generate\_main (int nfuncs, cuc\_func \*\*f, char \*filename)

Here is the call graph for this function:

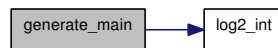

##### 6.77.1.2 void output\_verilog (cuc\_func \*func, char \*filename, char \*funcname)

Here is the call graph for this function:

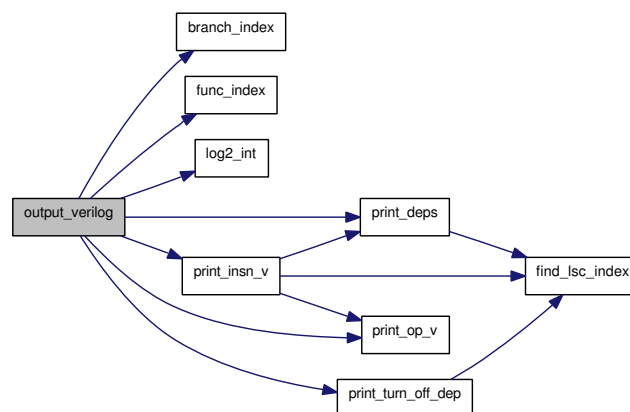

## 6.78 debug/debug-unit.c File Reference

```
#include "config.h"
#include "port.h"
#include <stdlib.h>
#include <stdio.h>
#include <assert.h>
#include "arch.h"
#include "debug-unit.h"
#include "sim-config.h"
#include "except.h"
#include "abstract.h"
#include "parse.h"
#include "gdb.h"
#include "opcode/or32.h"
#include "spr-defs.h"
#include "execute.h"
#include "sprs.h"
#include "toplevel-support.h"
#include "rsp-server.h"
```

Include dependency graph for debug-unit.c:

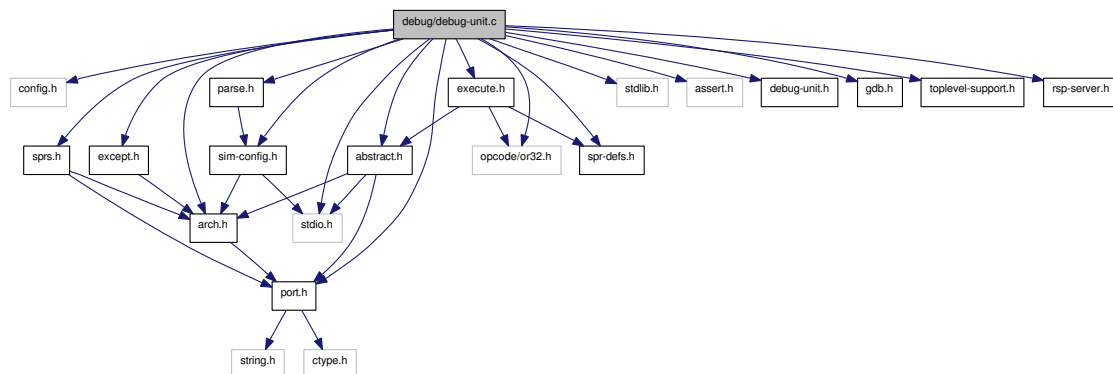

## Defines

- #define [RISCOP\\_STALL](#) 0x00000001
- #define [RISCOP\\_RESET](#) 0x00000002

## Enumerations

- enum `development_interface_address_space` { `DEVELOPINT_RISCOP` = 4, `DEVELOPINT_MAX` = 27 }

## Functions

- static int `calculate_watchpoints` (enum `debug_unit_action` action, unsigned long udata)
- static int `get_devint_reg` (unsigned int addr, unsigned long \*data)
- static int `set_devint_reg` (unsigned int addr, unsigned long data)
- static int `debug_set_mem` (`oraddr_t` address, `uorreg_t` data)
- static int `debug_get_mem` (`oraddr_t` address, `uorreg_t` \*data)
- void `du_reset` ()
- void `set_stall_state` (int state)
- int `check_debug_unit` (enum `debug_unit_action` action, unsigned long udata)
- int `debug_get_register` (`oraddr_t` address, `uorreg_t` \*data)
- int `debug_set_register` (`oraddr_t` address, `uorreg_t` data)
- int `debug_set_chain` (enum `debug_scan_chain_ids` chain)
- static int `get_devint_reg` (enum `development_interface_address_space` address, unsigned long \*data)
- static int `set_devint_reg` (enum `development_interface_address_space` address, unsigned long data)
- int `debug_ignore_exception` (unsigned long except)
- static void `debug_enabled` (union `param_val` val, void \*dat)
- static void `debug_gdb_enabled` (union `param_val` val, void \*dat)
- static void `debug_rsp_enabled` (union `param_val` val, void \*dat)
- static void `debug_server_port` (union `param_val` val, void \*dat)
- static void `debug_rsp_port` (union `param_val` val, void \*dat)
- static void `debug_vapi_id` (union `param_val` val, void \*dat)
- void `reg_debug_sec` ()

## Variables

- unsigned long `development` [`DEVELOPINT_MAX`+1]
- static enum `debug_scan_chain_ids` `current_scan_chain` = `JTAG_CHAIN_GLOBAL`
- static int `in_reset` = 0

### 6.78.1 Define Documentation

#### 6.78.1.1 #define RISCOP\_RESET 0x00000002

Reset processor (clears stall)

#### 6.78.1.2 #define RISCOP\_STALL 0x00000001

The fields for the RISCOP register in the development interface scan chain (`JTAG_CHAIN_DEVELOPMENT`). Stall processor

## 6.78.2 Enumeration Type Documentation

### 6.78.2.1 enum development\_interface\_address\_space

The various addresses in the development interface scan chain (JTAG\_CHAIN\_DEVELOPMENT). Only documents the ones we actually have

**Enumerator:**

*DEVELOPINT\_RISCOPE*  
*DEVELOPINT\_MAX*

## 6.78.3 Function Documentation

### 6.78.3.1 static int calculate\_watchpoints (enum debug\_unit\_action action, unsigned long udata) [static]

Forward declaration of static functions

Check whether we should stall the RISC or cause an exception.

Rewritten by JPB for current architecture.

**Parameters:**

- ← *action* The action to be checked
- ← *udata* The data to compare against (for some actions)

**Returns:**

Non-zero if this should generate a breakpoint

### 6.78.3.2 int check\_debug\_unit (enum debug\_unit\_action action, unsigned long udata)

Check for a breakpoint on this action

**Note:**

This does not include single-stepping - that will be picked up in the main loop AFTER the instruction has executed.

**Parameters:**

- ← *action* The action to be checked
- ← *udata* The data to compare against (for some actions)

**Returns:**

Non-zero if there was a breakpoint, 0 otherwise.

Here is the call graph for this function:





### 6.78.3.6 int debug\_get\_register (oraddr\_t address, uorreg\_t \* data)

Get a JTAG register

Action depends on which scan chain is currently active.

**Parameters:**

- ← *address* Address on the scan chain
- *data* Where to put the result of the read

**Returns:**

An error code (including ERR\_NONE) if there is no error

Here is the call graph for this function:

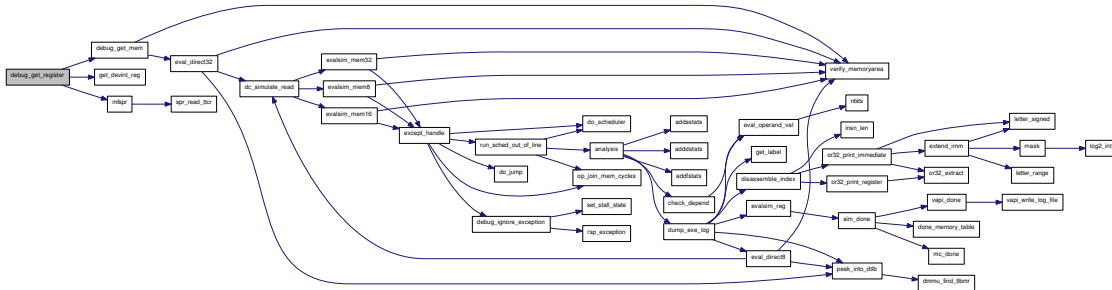

### 6.78.3.7 int debug\_ignore\_exception (unsigned long except)

See if an exception should be ignored

**Parameters:**

- ← *except* The exception to consider

**Returns:**

Non-zero if the exception should be ignored

Here is the call graph for this function:

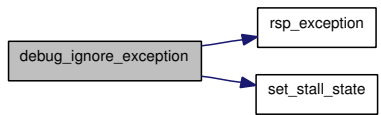

### 6.78.3.8 static void debug\_rsp\_enabled (union param\_val val, void \* dat) [static]

Enable or disable Remote Serial Protocol GDB interface to the debug unit

This is the preferred interface. It may only be specified if the RSP interface is not specified. If both are specified, the RSP will be used.

**Parameters:**

- ← *val* The value to use
- ← *dat* The [config](#) data structure (not used here)

**6.78.3.9 static void debug\_rsp\_port (union param\_val val, void \* dat) [static]**

Set the Remote Serial Protocol GDB server port

This is for use with the RSP, which is now the preferred interface. Ensure the value chosen is valid. Note that 0 is permitted, meaning the connection should be to the "or1ksim-rsp" service, rather than a port.

Both this and the legacy port may be specified, but only one may be enabled (see [debug\\_gdb\\_enabled\(\)](#) and [debug\\_rsp\\_enabled\(\)](#)).

**Parameters:**

- ← *val* The value to use
- ← *dat* The [config](#) data structure (not used here)

**6.78.3.10 static void debug\_server\_port (union param\_val val, void \* dat) [static]**

Set the legacy GDB server port

This is for use with the OpenRISC Remote JTAG protocol (now deprecated). Ensure the value chosen is valid. Note that 0 is permitted, meaning the connection should be to the "or1ksim" service, rather than a port.

Both this and the RSP port may be specified, but only one may be enabled (see [debug\\_gdb\\_enabled\(\)](#) and [debug\\_rsp\\_enabled\(\)](#)).

**Parameters:**

- ← *val* The value to use
- ← *dat* The [config](#) data structure (not used here)

**6.78.3.11 int debug\_set\_chain (enum debug\_scan\_chain\_ids chain)**

Set the JTAG chain

Only permit chains we support. Currently TRACE is not implemented.

**Parameters:**

- ← *chain* Chain to be set as current

**Returns:**

An error code (including `ERR_NONE`) if there is no error

### 6.78.3.12 static int debug\_set\_mem (oraddr\_t address, uint32\_t data) [static]

Write to main bus

#### Parameters:

- ← *address* Address to write to
- *data* Data to write

#### Returns:

An error code (including ERR\_NONE) if there is no error

Here is the call graph for this function:

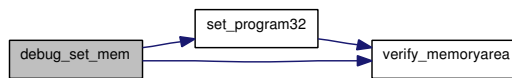

### 6.78.3.13 int debug\_set\_register (oraddr\_t address, uoreg\_t data)

Set a JTAG register

Action depends on which scan chain is currently active.

#### Parameters:

- ← *address* Address on the scan chain
- *data* Data to set

#### Returns:

An error code (including ERR\_NONE) if there is no error

Here is the call graph for this function:

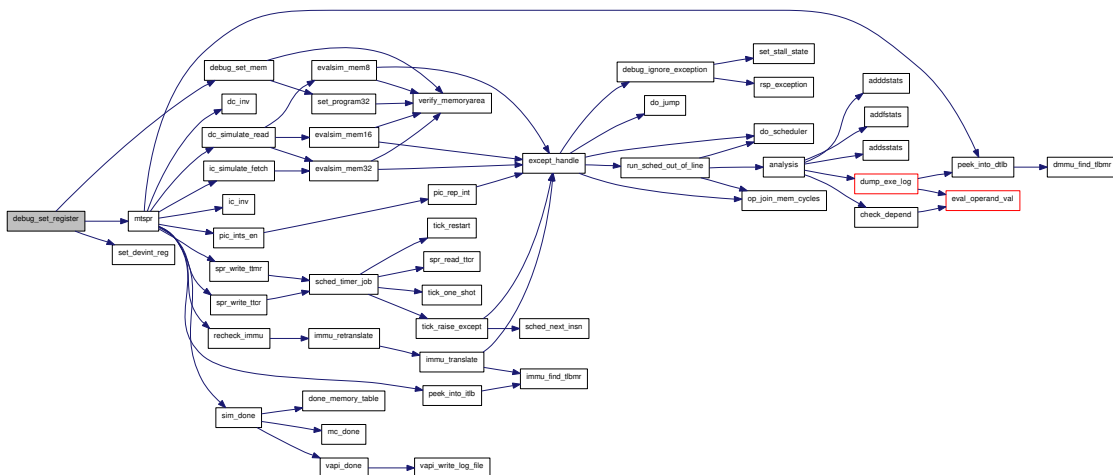



**6.78.3.14** `static void debug_vapi_id (union param_val val, void * dat)` [static]

Set the VAPI ID for the debug unit

**Parameters:**

- ← *val* The value to use
- ← *dat* The `config` data structure (not used here)

**6.78.3.15** `void du_reset ()`

Reset the debug unit

Clear all development interface registers

Here is the call graph for this function:

**6.78.3.16** `static int get_devint_reg (enum development_interface_address_space address, unsigned long * data)` [static]

Get a development interface register

No side effects on get - just return the register

**Parameters:**

- ← *address* The register to get
- *data* Where to put the result

**Returns:**

An error code (including `ERR_NONE`) if there is no error

**6.78.3.17** `static int get_devint_reg (unsigned int addr, unsigned long * data)` [static]**6.78.3.18** `void reg_debug_sec ()`

Register the configuration functions for the debug unit



**6.78.3.20** `static int set_devint_reg (unsigned int addr, unsigned long data)` [static]

**6.78.3.21** `void set_stall_state (int state)`

Set the stall state of the processor

**Parameters:**

← *state* If non-zero stall the processor.

## 6.78.4 Variable Documentation

**6.78.4.1** `enum debug_scan_chain_ids current_scan_chain = JTAG_CHAIN_GLOBAL`  
[static]

The current scan chain being accessed

**6.78.4.2** `unsigned long development[DEVELOPINT_MAX+1]`

Data structure holding debug registers and their bits

**6.78.4.3** `int in_reset = 0` [static]

External STALL signal to debug interface

## 6.79 debug/debug-unit.h File Reference

This graph shows which files directly or indirectly include this file:

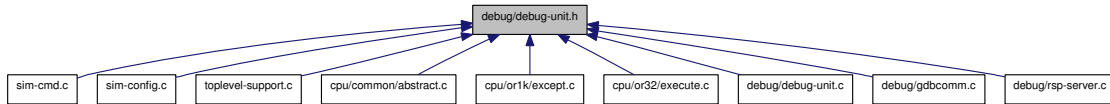

### Enumerations

- enum `debug_unit_action` {  
`DebugInstructionFetch = 1, DebugLoadAddress = 2, DebugStoreAddress = 3, DebugLoadData = 4, DebugStoreData = 5` }
- enum `debug_scan_chain_ids` {  
`JTAG_CHAIN_GLOBAL = 0, JTAG_CHAIN_DEBUG_UNIT = 1, JTAG_CHAIN_TRACE = 3, JTAG_CHAIN_DEVELOPMENT = 4, JTAG_CHAIN_WISHBONE = 5` }

### Functions

- void `du_reset` ()
- void `set_stall_state` (int state)
- int `check_debug_unit` (enum `debug_unit_action` action, unsigned long udata)
- int `debug_get_register` (oraddr\_t address, uorreg\_t \*data)
- int `debug_set_register` (oraddr\_t address, uorreg\_t data)
- int `debug_set_chain` (enum `debug_scan_chain_ids` chain)
- int `debug_ignore_exception` (unsigned long except)
- void `reg_debug_sec` ()

### 6.79.1 Enumeration Type Documentation

#### 6.79.1.1 enum debug\_scan\_chain\_ids

Enumeration of the various JTAG scan chains. Only those actually implemented are specified.

Enumerator:

*JTAG\_CHAIN\_GLOBAL*  
*JTAG\_CHAIN\_DEBUG\_UNIT*  
*JTAG\_CHAIN\_TRACE*  
*JTAG\_CHAIN\_DEVELOPMENT*  
*JTAG\_CHAIN\_WISHBONE*

### 6.79.1.2 enum debug\_unit\_action

The possible debug unit actions

**Enumerator:**

*DebugInstructionFetch*

*DebugLoadAddress*

*DebugStoreAddress*

*DebugLoadData*

*DebugStoreData*

### 6.79.2 Function Documentation

#### 6.79.2.1 int check\_debug\_unit (enum debug\_unit\_action *action*, unsigned long *udata*)

Check for a breakpoint on this action

**Note:**

This does not include single-stepping - that will be picked up in the main loop AFTER the instruction has executed.

**Parameters:**

← *action* The action to be checked

← *udata* The data to compare against (for some actions)

**Returns:**

Non-zero if there was a breakpoint, 0 otherwise.

Here is the call graph for this function:



#### 6.79.2.2 int debug\_get\_register (oraddr\_t *address*, uorreg\_t \* *data*)

Get a JTAG register

Action depends on which scan chain is currently active.

**Parameters:**

← *address* Address on the scan chain

→ *data* Where to put the result of the read

**Returns:**

An error code (including ERR\_NONE) if there is no error



**Parameters:**

← *address* Address on the scan chain

→ *data* Data to set

**Returns:**

An error code (including ERR\_NONE) if there is no error

Here is the call graph for this function:

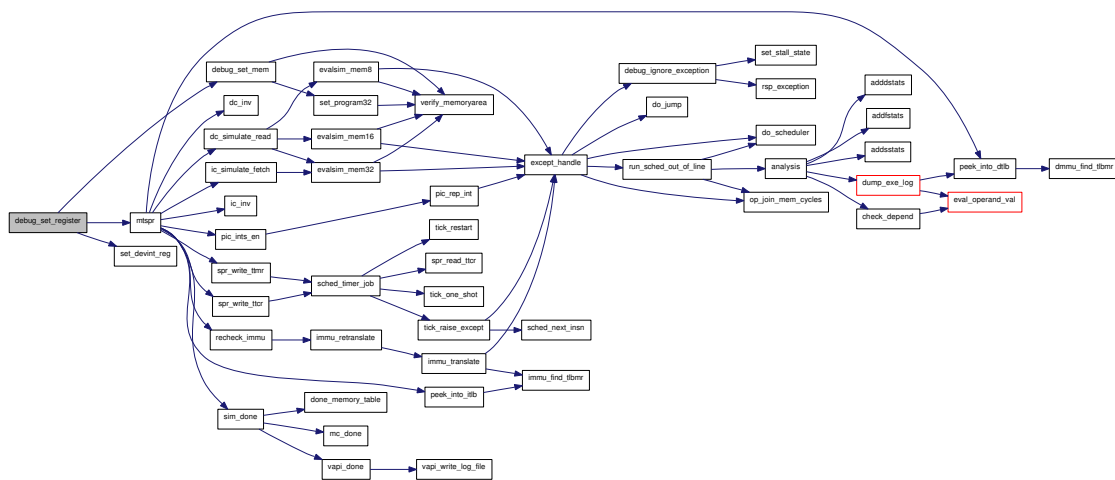
**6.79.2.6 void du\_reset ()**

Reset the debug unit

Clear all development interface registers

Here is the call graph for this function:

**6.79.2.7 void reg\_debug\_sec ()**

Register the configuration functions for the debug unit

Here is the call graph for this function:

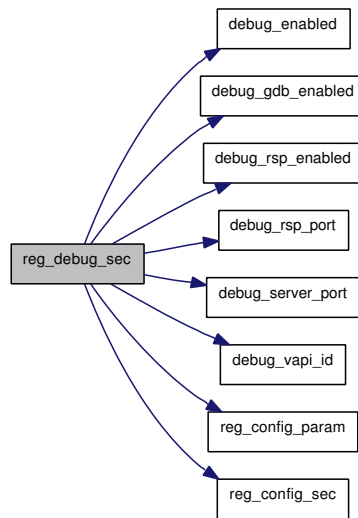

#### 6.79.2.8 void set\_stall\_state (int state)

Set the stall state of the processor

**Parameters:**

← *state* If non-zero stall the processor.



## 6.80 debug/gdb.h File Reference

This graph shows which files directly or indirectly include this file:

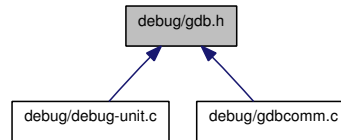

### Data Structures

- struct [jtr\\_read\\_message](#)
- struct [jtr\\_write\\_message](#)
- struct [jtr\\_read\\_block\\_message](#)
- struct [jtr\\_write\\_block\\_message](#)
- struct [jtr\\_chain\\_message](#)
- struct [jtr\\_failure\\_response](#)
- struct [jtr\\_read\\_response](#)
- struct [jtr\\_write\\_response](#)
- struct [jtr\\_read\\_block\\_response](#)
- struct [jtr\\_write\\_block\\_response](#)
- struct [jtr\\_chain\\_response](#)

### Enumerations

- enum [or1k\\_jtag\\_errors](#) {  
ERR\_NONE = 0, ERR\_CRC = -1, ERR\_MEM = -2, JTAG\_PROXY\_INVALID\_COMMAND = -3,  
JTAG\_PROXY\_SERVER\_TERMINATED = -4, JTAG\_PROXY\_NO\_CONNECTION = -5, JTAG\_PROXY\_PROTOCOL\_ERROR = -6, JTAG\_PROXY\_COMMAND\_NOT\_IMPLEMENTED = -7,  
JTAG\_PROXY\_INVALID\_CHAIN = -8, JTAG\_PROXY\_INVALID\_ADDRESS = -9, JTAG\_PROXY\_ACCESS\_EXCEPTION = -10, JTAG\_PROXY\_INVALID\_LENGTH = -11,  
JTAG\_PROXY\_OUT\_OF\_MEMORY = -12 }
- enum [or1k\\_jtag\\_proxy\\_protocol\\_commands](#) {  
OR1K\_JTAG\_COMMAND\_READ = 1, OR1K\_JTAG\_COMMAND\_WRITE = 2, OR1K\_JTAG\_COMMAND\_READ\_BLOCK = 3, OR1K\_JTAG\_COMMAND\_WRITE\_BLOCK = 4,  
OR1K\_JTAG\_COMMAND\_CHAIN = 5 }

### 6.80.1 Enumeration Type Documentation

#### 6.80.1.1 enum or1k\_jtag\_errors

Error codes for the OpenRISC 1000 JTAG debugging protocol

**Enumerator:**

*ERR\_NONE*

*ERR\_CRC*

*ERR\_MEM*  
*JTAG\_PROXY\_INVALID\_COMMAND*  
*JTAG\_PROXY\_SERVER\_TERMINATED*  
*JTAG\_PROXY\_NO\_CONNECTION*  
*JTAG\_PROXY\_PROTOCOL\_ERROR*  
*JTAG\_PROXY\_COMMAND\_NOT\_IMPLEMENTED*  
*JTAG\_PROXY\_INVALID\_CHAIN*  
*JTAG\_PROXY\_INVALID\_ADDRESS*  
*JTAG\_PROXY\_ACCESS\_EXCEPTION*  
*JTAG\_PROXY\_INVALID\_LENGTH*  
*JTAG\_PROXY\_OUT\_OF\_MEMORY*

#### 6.80.1.2 enum or1k\_jtag\_proxy\_protocol\_commands

The OR1K JTAG proxy protocol commands.

**Enumerator:**

*ORIK\_JTAG\_COMMAND\_READ*  
*ORIK\_JTAG\_COMMAND\_WRITE*  
*ORIK\_JTAG\_COMMAND\_READ\_BLOCK*  
*ORIK\_JTAG\_COMMAND\_WRITE\_BLOCK*  
*ORIK\_JTAG\_COMMAND\_CHAIN*

## 6.81 debug/gdbcomm.c File Reference

```
#include "config.h"
#include "port.h"
#include <stdlib.h>
#include <unistd.h>
#include <stdio.h>
#include <sys/poll.h>
#include <sys/types.h>
#include <sys/socket.h>
#include <netinet/in.h>
#include <fcntl.h>
#include <netdb.h>
#include <netinet/tcp.h>
#include <errno.h>
#include "sim-config.h"
#include "gdb.h"
#include "gdbcomm.h"
#include "debug-unit.h"
#include "vapi.h"
```

Include dependency graph for gdbcomm.c:

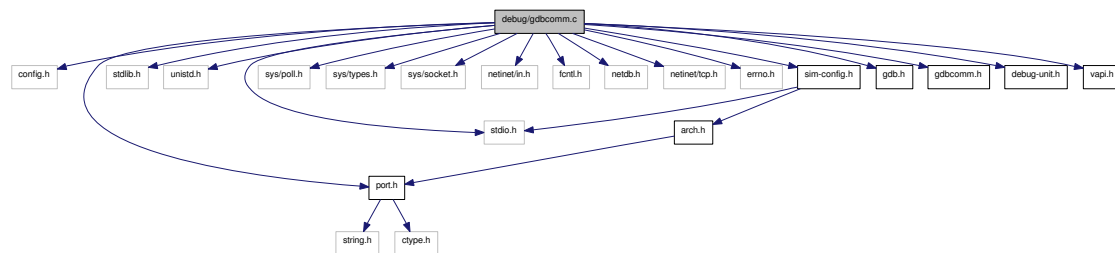

## Functions

- static void [jtag\\_request](#) ()
- static void [gdb\\_request](#) (void)
- static void [protocol\\_clean](#) (int, int32\_t)
- static int [get\\_server\\_socket](#) (const char \*name, const char \*proto, int port)
- static int [gdb\\_read](#) (void \*buf, int len)
- static int [gdb\\_write](#) (const void \*buf, int len)
- void [block\\_jtag](#) ()
- void [handle\\_server\\_socket](#) (enum boolean block)
- void [gdbcomm\\_init](#) ()

## Variables

- static unsigned int `server_ip` = 0
- static unsigned int `server_port` = 0
- static unsigned int `server_fd` = 0
- static unsigned int `gdb_fd` = 0
- static int `tcp_level` = 0

## 6.81.1 Function Documentation

### 6.81.1.1 void `block_jtag` ()

### 6.81.1.2 static int `gdb_read` (void \* *buf*, int *len*) [static]

Here is the call graph for this function:



### 6.81.1.3 static void `gdb_request` (void) [static]

Here is the call graph for this function:

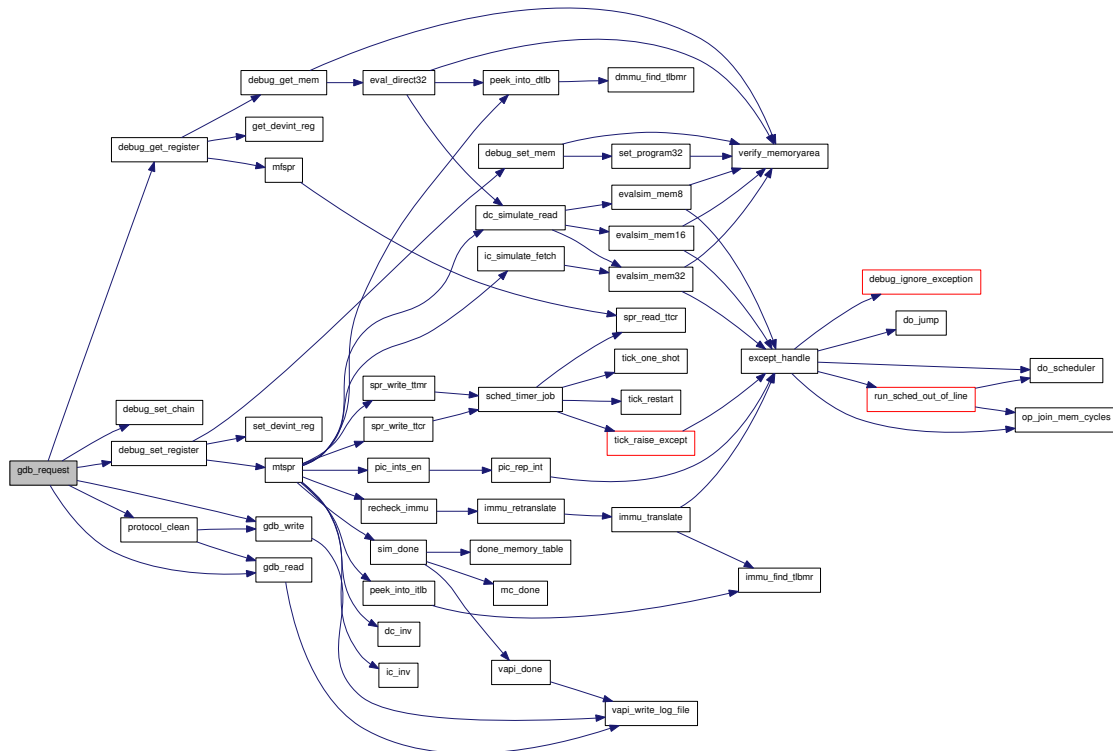

#### 6.81.1.4 static int gdb\_write (const void \* buf, int len) [static]

Here is the call graph for this function:



#### 6.81.1.5 void gdbcomm\_init ()

Here is the call graph for this function:



#### 6.81.1.6 static int get\_server\_socket (const char \* name, const char \* proto, int port) [static]

#### 6.81.1.7 void handle\_server\_socket (enum boolean block)

Here is the call graph for this function:

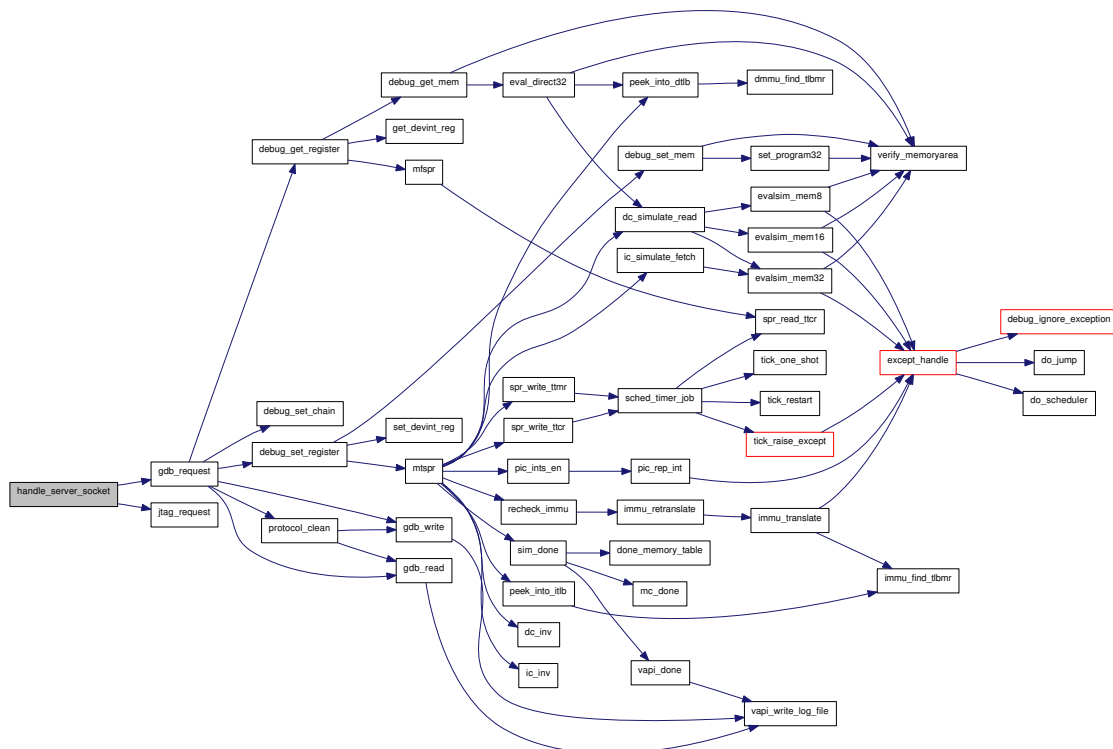

**6.81.1.8** `static void jtag_request (void)` [static]

**6.81.1.9** `static void protocol_clean (int length, int32_t err)` [static]

Here is the call graph for this function:

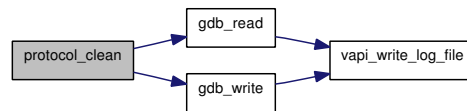

## 6.81.2 Variable Documentation

**6.81.2.1** `unsigned int gdb_fd = 0` [static]

**6.81.2.2** `unsigned int server_fd = 0` [static]

**6.81.2.3** `unsigned int server_ip = 0` [static]

**6.81.2.4** `unsigned int server_port = 0` [static]

**6.81.2.5** `int tcp_level = 0` [static]

## 6.82 debug/gdbcomm.h File Reference

This graph shows which files directly or indirectly include this file:

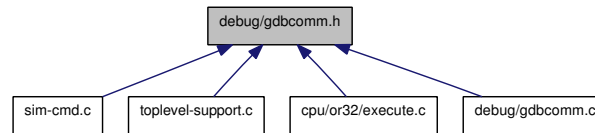

### Enumerations

- enum `boolean` { `FALSE` = 0, `TRUE` = 1 }

### Functions

- void `handle_server_socket` (enum `boolean`)
- void `block_jtag` ()
- void `gdbcomm_init` ()

### 6.82.1 Enumeration Type Documentation

#### 6.82.1.1 enum `boolean`

Enumerator:

*FALSE*

*TRUE*

### 6.82.2 Function Documentation

#### 6.82.2.1 void `block_jtag` ()

#### 6.82.2.2 void `gdbcomm_init` ()

Here is the call graph for this function:



### 6.82.2.3 void handle\_server\_socket (enum boolean)

Here is the call graph for this function:

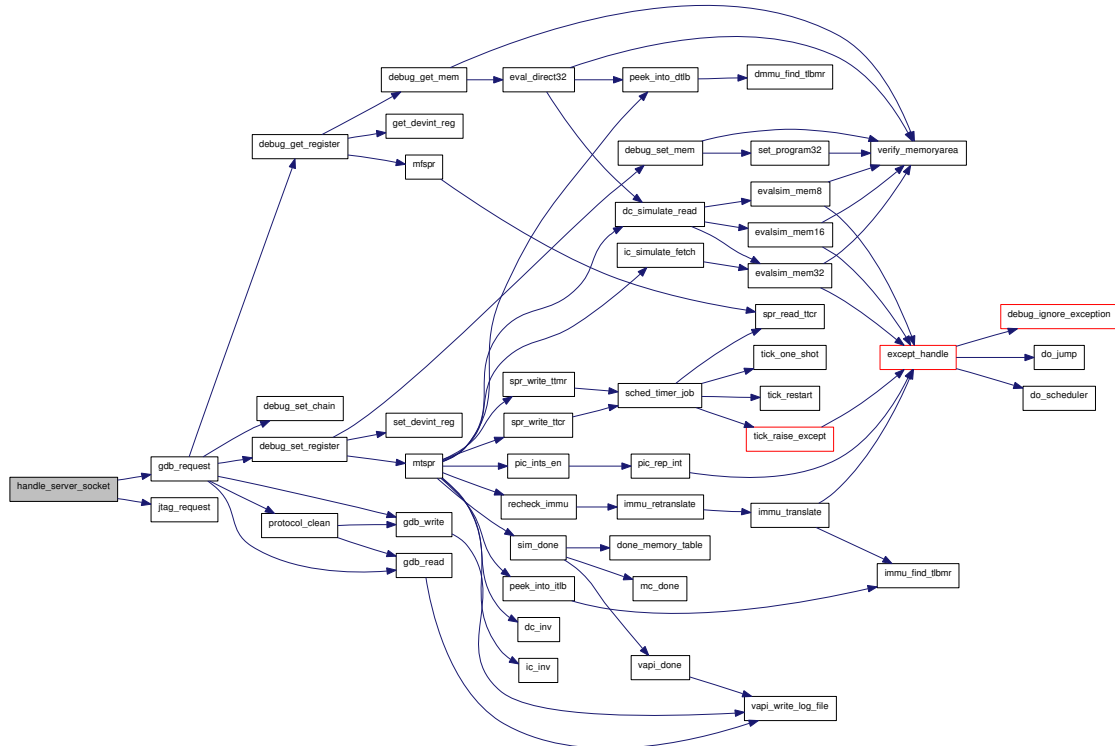



## 6.83 debug/rsp-server.c File Reference

```

#include "config.h"
#include "port.h"
#include <stdlib.h>
#include <unistd.h>
#include <netdb.h>
#include <stdio.h>
#include <errno.h>
#include <sys/types.h>
#include <sys/socket.h>
#include <fcntl.h>
#include <arpa/inet.h>
#include <poll.h>
#include <netinet/tcp.h>
#include <signal.h>
#include "sim-config.h"
#include "except.h"
#include "opcode/or32.h"
#include "spr-defs.h"
#include "execute.h"
#include "debug-unit.h"
#include "sprs.h"
#include "toplevel-support.h"

```

Include dependency graph for rsp-server.c:

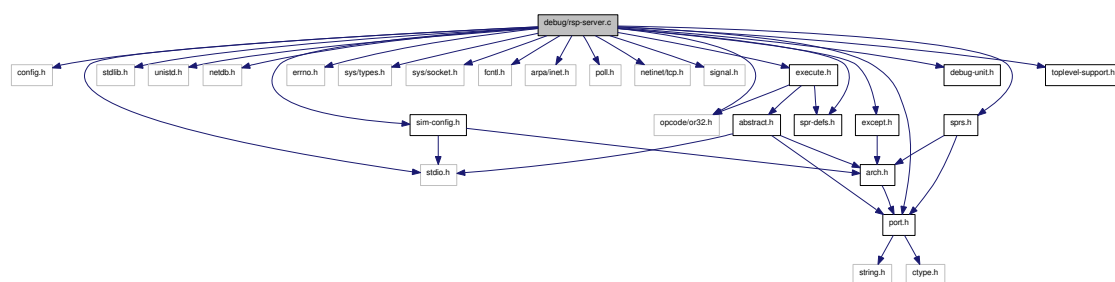

## Data Structures

- struct [rsp\\_buf](#)
- struct [mp\\_entry](#)

## Defines

- #define `OR1KSIM_RSP_SERVICE` "or1ksim-rsp"
- #define `OR1KSIM_RSP_PROTOCOL` "tcp"
- #define `OR1KSIM_TID` 1
- #define `PPC_REGNUM` (MAX\_GPRS + 0)
- #define `NPC_REGNUM` (MAX\_GPRS + 1)
- #define `SR_REGNUM` (MAX\_GPRS + 2)
- #define `NUM_REGS` (MAX\_GPRS + 3)
- #define `OR1K_TRAP_INSTR` 0x21000001
- #define `GDB_BUF_MAX` ((NUM\_REGS) \* 8 + 1)
- #define `MP_HASH_SIZE` 1021

## Enumerations

- enum `target_signal` {  
`TARGET_SIGNAL_NONE` = 0, `TARGET_SIGNAL_INT` = 2, `TARGET_SIGNAL_ILL` = 4,  
`TARGET_SIGNAL_TRAP` = 5,  
`TARGET_SIGNAL_FPE` = 8, `TARGET_SIGNAL_BUS` = 10, `TARGET_SIGNAL_SEGV` = 11,  
`TARGET_SIGNAL_ALRM` = 14,  
`TARGET_SIGNAL_USR2` = 31, `TARGET_SIGNAL_PWR` = 32 }
- enum `mp_type` {  
`BP_MEMORY` = 0, `BP_HARDWARE` = 1, `WP_WRITE` = 2, `WP_READ` = 3,  
`WP_ACCESS` = 4 }

## Functions

- static void `rsp_get_client` ()
- static void `rsp_client_request` ()
- static void `rsp_client_close` ()
- static void `put_packet` (struct `rsp_buf` \*buf)
- static void `put_str_packet` (const char \*str)
- static struct `rsp_buf` \* `get_packet` ()
- static void `put_rsp_char` (char c)
- static int `get_rsp_char` ()
- static int `rsp_unescape` (char \*data, int len)
- static void `mp_hash_init` ()
- static void `mp_hash_add` (enum `mp_type` type, unsigned long int addr, unsigned long int instr)
- static struct `mp_entry` \* `mp_hash_lookup` (enum `mp_type` type, unsigned long int addr)
- static struct `mp_entry` \* `mp_hash_delete` (enum `mp_type` type, unsigned long int addr)
- static int `hex` (int c)
- static void `reg2hex` (unsigned long int val, char \*buf)
- static unsigned long int `hex2reg` (char \*buf)
- static void `ascii2hex` (char \*dest, char \*src)
- static void `hex2ascii` (char \*dest, char \*src)
- static void `set_npc` (unsigned long int addr)
- static void `rsp_report_exception` ()
- static void `rsp_continue` (struct `rsp_buf` \*buf)

- static void `rsp_continue_with_signal` (struct `rsp_buf` \*buf)
- static void `rsp_continue_generic` (unsigned long int addr, unsigned long int except)
- static void `rsp_read_all_regs` ()
- static void `rsp_write_all_regs` (struct `rsp_buf` \*buf)
- static void `rsp_read_mem` (struct `rsp_buf` \*buf)
- static void `rsp_write_mem` (struct `rsp_buf` \*buf)
- static void `rsp_read_reg` (struct `rsp_buf` \*buf)
- static void `rsp_write_reg` (struct `rsp_buf` \*buf)
- static void `rsp_query` (struct `rsp_buf` \*buf)
- static void `rsp_command` (struct `rsp_buf` \*buf)
- static void `rsp_set` (struct `rsp_buf` \*buf)
- static void `rsp_restart` ()
- static void `rsp_step` (struct `rsp_buf` \*buf)
- static void `rsp_step_with_signal` (struct `rsp_buf` \*buf)
- static void `rsp_step_generic` (unsigned long int addr, unsigned long int except)
- static void `rsp_vpkt` (struct `rsp_buf` \*buf)
- static void `rsp_write_mem_bin` (struct `rsp_buf` \*buf)
- static void `rsp_remove_matchpoint` (struct `rsp_buf` \*buf)
- static void `rsp_insert_matchpoint` (struct `rsp_buf` \*buf)
- void `rsp_init` ()
- void `handle_rsp` ()
- void `rsp_exception` (unsigned long int except)

## Variables

- static const char `hexchars` [] = "0123456789abcdef"
  - struct {
    - int `client_waiting`
    - int `proto_num`
    - int `client_fd`
    - int `sigval`
    - unsigned long int `start_addr`
    - struct `mp_entry` \* `mp_hash` [MP\_HASH\_SIZE]
- } `rsp`

### 6.83.1 Define Documentation

#### 6.83.1.1 #define GDB\_BUF\_MAX ((NUM\_REGS) \* 8 + 1)

The maximum number of characters in inbound/outbound buffers. The largest packets are the 'G' packet, which must hold the 'G' and all the registers with two hex digits per byte and the 'g' reply, which must hold all the registers, and (in our implementation) an end-of-string (0) character. Adding the EOS allows us to print out the packet as a string. So at least NUMREGBYTES\*2 + 1 (for the 'G' or the EOS) are needed for register packets

#### 6.83.1.2 #define MP\_HASH\_SIZE 1021

Size of the matchpoint hash table. Largest prime < 2<sup>10</sup>

**6.83.1.3 #define NPC\_REGNUM (MAX\_GPRS + 1)**

Next PC

**6.83.1.4 #define NUM\_REGS (MAX\_GRPS + 3)**

Total GDB registers

**6.83.1.5 #define OR1K\_TRAP\_INSTR 0x21000001**

Trap instruction for OR32

**6.83.1.6 #define OR1KSIM\_RSP\_PROTOCOL "tcp"**

Protocol used by Or1ksim

**6.83.1.7 #define OR1KSIM\_RSP\_SERVICE "or1ksim-rsp"**

Name of the Or1ksim RSP service

**6.83.1.8 #define OR1KSIM\_TID 1**

Thread ID used by Or1ksim

**6.83.1.9 #define PPC\_REGNUM (MAX\_GPRS + 0)**

Previous PC

**6.83.1.10 #define SR\_REGNUM (MAX\_GPRS + 2)**

Supervision Register

**6.83.2 Enumeration Type Documentation****6.83.2.1 enum mp\_type**

Enumeration of different types of matchpoint. These have explicit values matching the second digit of 'z' and 'Z' packets.

**Enumerator:**

*BP\_MEMORY*

*BP\_HARDWARE*

*WP\_WRITE*

*WP\_READ*

*WP\_ACCESS*

### 6.83.2.2 enum target\_signal

Definition of GDB target signals. Data taken from the GDB 6.8 source. Only those we use defined here.

Enumerator:

*TARGET\_SIGNAL\_NONE*  
*TARGET\_SIGNAL\_INT*  
*TARGET\_SIGNAL\_ILL*  
*TARGET\_SIGNAL\_TRAP*  
*TARGET\_SIGNAL\_FPE*  
*TARGET\_SIGNAL\_BUS*  
*TARGET\_SIGNAL\_SEGV*  
*TARGET\_SIGNAL\_ALRM*  
*TARGET\_SIGNAL\_USR2*  
*TARGET\_SIGNAL\_PWR*

### 6.83.3 Function Documentation

#### 6.83.3.1 static void ascii2hex (char \* dest, char \* src) [static]

Convert an ASCII character string to pairs of hex digits

Both source and destination are null terminated.

Parameters:

- *dest* Buffer to store the hex digit pairs (null terminated)
- ← *src* The ASCII string (null terminated)

#### 6.83.3.2 static struct rsp\_buf \* get\_packet () [static, read]

Get a packet from the GDB client

Modeled on the stub version supplied with GDB. The data is in a static buffer. The data should be copied elsewhere if it is to be preserved across a subsequent call to `get_packet()`.

Unlike the reference implementation, we don't deal with sequence numbers. GDB has never used them, and this implementation is only intended for use with GDB 6.8 or later. Sequence numbers were removed from the RSP standard at GDB 5.0.

Returns:

A pointer to the static buffer containing the data

Here is the call graph for this function:

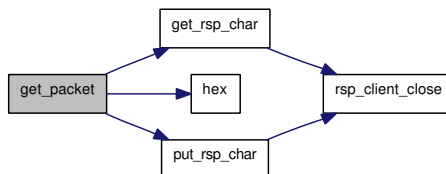

### 6.83.3.3 static int get\_rsp\_char () [static]

Get a single character from the client socket

This should only be called if the client is open, but we check for safety.

#### Returns:

The character read, or -1 on failure

Here is the call graph for this function:



### 6.83.3.4 void handle\_rsp ()

Look for action on RSP

This function is called when the processor has stalled, which, except for initialization, must be due to an interrupt.

If we have no RSP client, we get one. We can make no progress until the client is available.

Then if the cause is an exception following a step or continue command, and the exception not been notified to GDB, a packet reporting the cause of the exception is sent.

The next client request is then processed.



**Returns:**

The value of the hex character, or -1 if the character is invalid.

**6.83.3.6 static void hex2ascii (char \* *dest*, char \* *src*) [static]**

Convert pairs of hex digits to an ASCII character string

Both source and destination are null terminated.

**Parameters:**

→ *dest* The ASCII string (null terminated)

← *src* Buffer holding the hex digit pairs (null terminated)

Here is the call graph for this function:

**6.83.3.7 static unsigned long int hex2reg (char \* *buf*) [static]**

Convert a hex digit string to a register value

The supplied 8 digit hex string is converted to a 32-bit value according the target endianism

**Parameters:**

← *buf* The buffer with the hex string

**Returns:**

The value to convert

Here is the call graph for this function:

**6.83.3.8 static void mp\_hash\_add (enum mp\_type *type*, unsigned long int *addr*, unsigned long int *instr*) [static]**

Add an entry to the matchpoint hash table

Add the entry if it wasn't already there. If it was there do nothing. The match just be on type and addr. The instr need not match, since if this is a duplicate insertion (perhaps due to a lost packet) they will be different.

**Parameters:**

← *type* The type of matchpoint

← *addr* The address of the matchpoint [in] *instr* The instruction to associate with the address



**6.83.3.9** `static struct mp_entry * mp_hash_delete (enum mp_type type, unsigned long int addr)`  
[static, read]

Delete an entry from the matchpoint hash table

If it is there the entry is deleted from the hash table. If it is not there, no action is taken. The match must be on type AND addr.

The usual fun and games tracking the previous entry, so we can delete things.

**Note:**

The deletion DOES NOT free the memory associated with the entry, since that is returned. The caller should free the memory when they have used the information.

**Parameters:**

- ← *type* The type of matchpoint
- ← *addr* The address of the matchpoint

**Returns:**

The entry deleted, or NULL if the entry was not found

**6.83.3.10** `static void mp_hash_init ()` [static]

Initialize the matchpoint hash table

This is an open hash table, so this function clears all the links to NULL.

**6.83.3.11** `static struct mp_entry * mp_hash_lookup (enum mp_type type, unsigned long int addr)`  
[static, read]

Look up an entry in the matchpoint hash table

The match must be on type AND addr.

**Parameters:**

- ← *type* The type of matchpoint
- ← *addr* The address of the matchpoint

**Returns:**

The entry deleted, or NULL if the entry was not found

**6.83.3.12** `static void put_packet (struct rsp_buf * buf)` [static]

Send a packet to the GDB client

Modeled on the stub version supplied with GDB. Put out the data preceded by a '\$', followed by a '#' and a one byte checksum. '\$', '#', '\*' and '}' are escaped by preceding them with '}' and then XORing the character with 0x20.

**Parameters:**

← *buf* The data to send

Here is the call graph for this function:

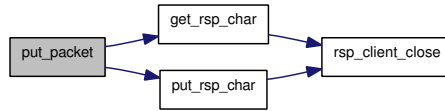
**6.83.3.13 static void put\_rsp\_char (char c) [static]**

Put a single character out onto the client socket

This should only be called if the client is open, but we check for safety.

**Parameters:**

← *c* The character to put out

Here is the call graph for this function:

**6.83.3.14 static void put\_str\_packet (const char \* str) [static]**

Convenience to put a constant string packet

param[in] str The text of the packet

Here is the call graph for this function:

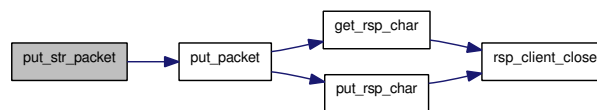
**6.83.3.15 static void reg2hex (unsigned long int val, char \* buf) [static]**

Convert a register to a hex digit string

The supplied 32-bit value is converted to an 8 digit hex string according the target endianism. It is null terminated for convenient printing.

**Parameters:**

← *val* The value to convert

→ *buf* The buffer for the text string

**6.83.3.16** `static void rsp_client_close ()` [static]

Close the connection to the client if it is open

**6.83.3.17** `static void rsp_client_request ()` [static]

Deal with a request from the GDB client session

In general, apart from the simplest requests, this function relies on other functions to implement the functionality.

Here is the call graph for this function:

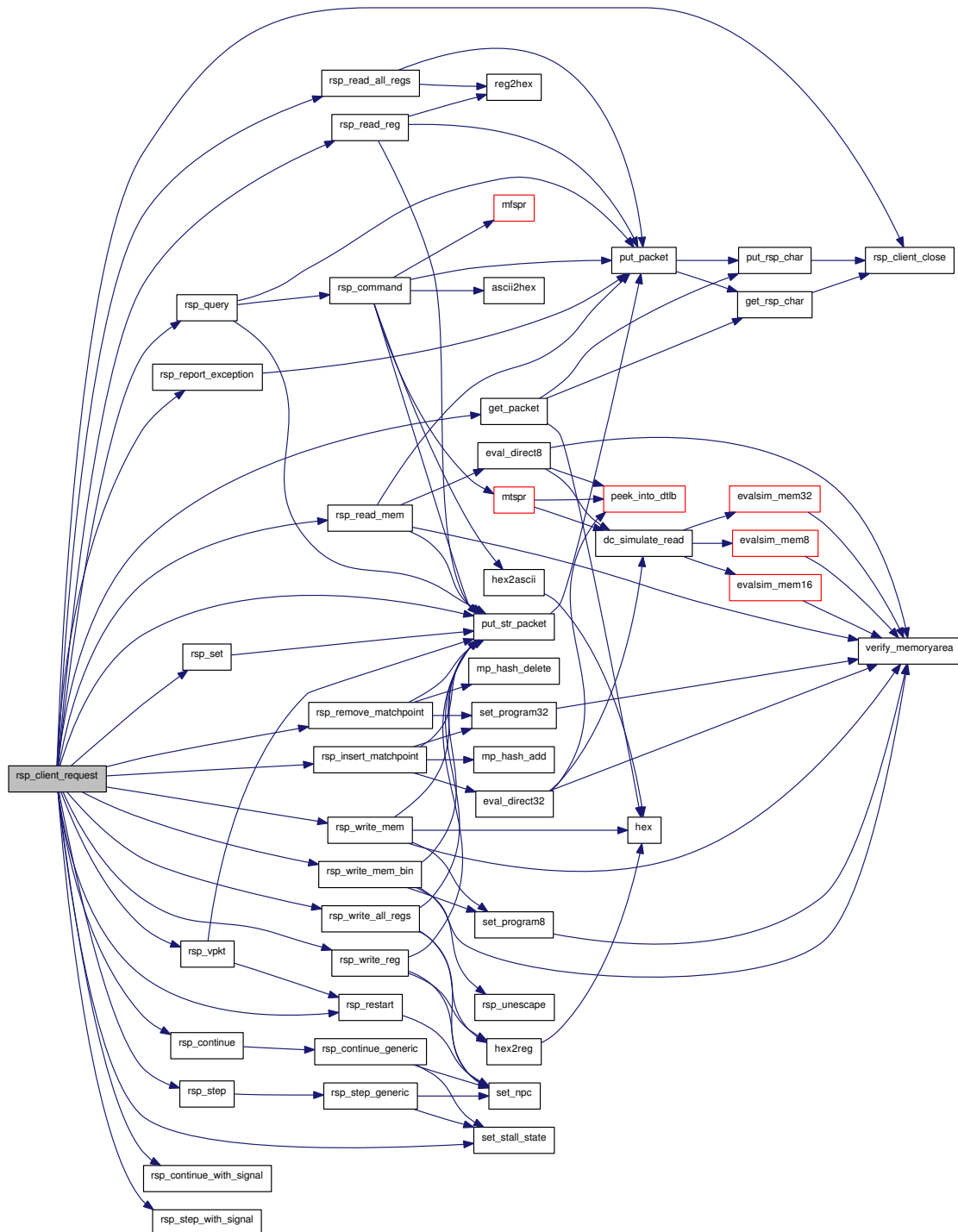

### 6.83.3.18 static void rsp\_command (struct rsp\_buf \* buf) [static]

Handle a RSP qRcmd request

The actual command follows the "qRcmd," in ASCII encoded to hex

### Parameters:

← *buf* The request in full

Here is the call graph for this function:

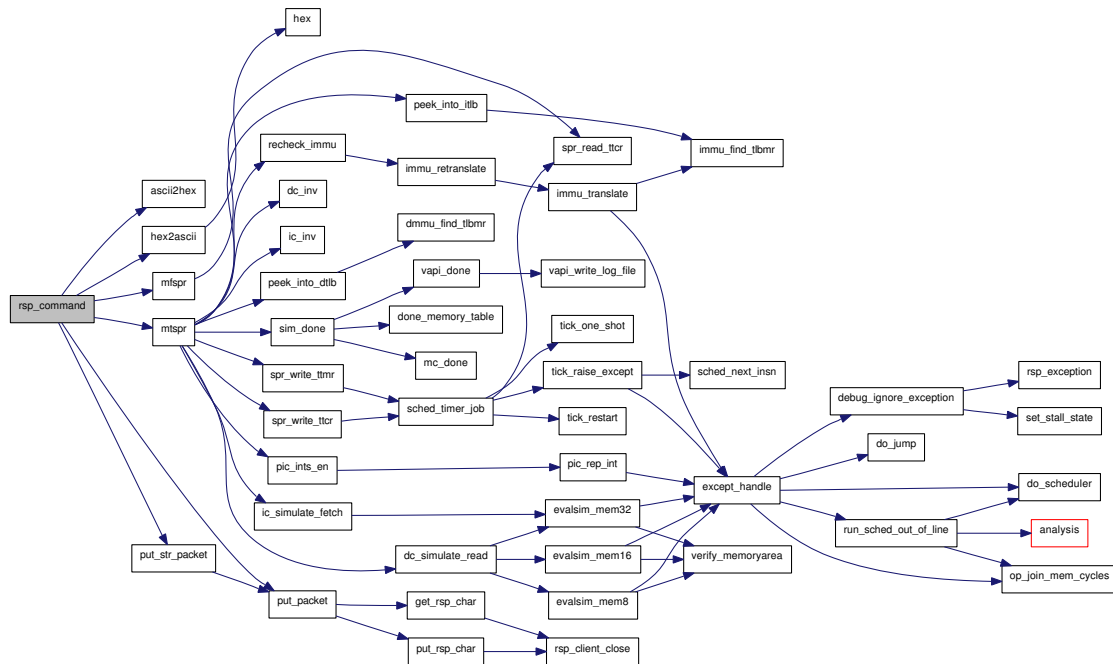

### 6.83.3.19 static void rsp\_continue (struct rsp\_buf \* buf) [static]

Handle a RSP continue request

Parse the command to see if there is an address. Uses the underlying generic continue function, with EXCEPT\_NONE.

### Parameters:

← *buf* The full continue packet

Here is the call graph for this function:

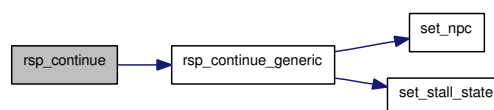

### 6.83.3.20 `static void rsp_continue_generic (unsigned long int addr, unsigned long int except)` `[static]`

Generic processing of a continue request

The signal may be EXCEPT\_NONE if there is no exception to be handled. Currently the exception is ignored.

The single step flag is cleared in the debug registers and then the processor is unstalled.

#### Parameters:

- ← *addr* Address from which to step
- ← *except* The exception to use (if any)

Here is the call graph for this function:

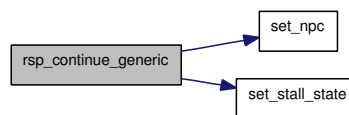

### 6.83.3.21 `static void rsp_continue_with_signal (struct rsp_buf * buf)` `[static]`

Handle a RSP continue with signal request

Currently null. Will use the underlying generic continue function.

#### Parameters:

- ← *buf* The full continue with signal packet

### 6.83.3.22 `void rsp_exception (unsigned long int except)`

Note an exception for future processing

The simulator has encountered an exception. Record it here, so that a future call to `handle_exception` will report it back to the client. The signal is supplied in Or1ksim form and recorded in GDB form.

We flag up a warning if an exception is already pending, and ignore the earlier exception.

#### Parameters:

- ← *except* The exception (Or1ksim form)

### 6.83.3.23 `static void rsp_get_client ()` `[static]`

Get a new client connection.

Blocks until the client connection is available.

A lot of this code is copied from `remote_open` in `gdbserver remote-utils.c`.

This involves setting up a socket to listen on a socket for attempted connections from a single GDB instance (we couldn't be talking to multiple GDBs at once!).

The service is specified either as a port number in the Or1ksim configuration (parameter `rsp_port` in section `debug`, default 51000) or as a service name in the constant `OR1KSIM_RSP_SERVICE`.

The protocol used for communication is specified in `OR1KSIM_RSP_PROTOCOL`.

Here is the call graph for this function:

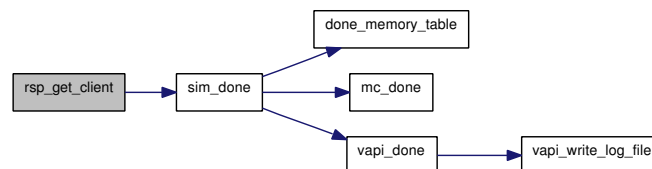

#### 6.83.3.24 void rsp\_init ()

Initialize the Remote Serial Protocol connection

Set up the central data structures.

Here is the call graph for this function:



#### 6.83.3.25 static void rsp\_insert\_matchpoint (struct rsp\_buf \* buf) [static]

Handle a RSP insert breakpoint or matchpoint request

For now only memory breakpoints are implemented, which are implemented by substituting a breakpoint at the specified address. The implementation must cope with the possibility of duplicate packets.

#### Todo

This doesn't work with icache/immu yet

#### Parameters:

← *buf* The command received





### 6.83.3.27 static void rsp\_read\_all\_regs () [static]

Handle a RSP read all registers request

The registers follow the GDB sequence for OR1K: GPR0 through GPR31, PPC (i.e. SPR PPC), NPC (i.e. SPR NPC) and SR (i.e. SPR SR). Each register is returned as a sequence of bytes in target endian order.

Each byte is packed as a pair of hex digits.

Here is the call graph for this function:

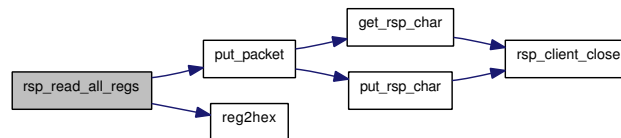

### 6.83.3.28 static void rsp\_read\_mem (struct rsp\_buf \* buf) [static]

Handle a RSP read memory (symbolic) request

Syntax is:

m<addr>,<length>:

The response is the bytes, lowest address first, encoded as pairs of hex digits.

The length given is the number of bytes to be read.

#### Note:

This function reuses buf, so trashes the original command.

#### Parameters:

← *buf* The command received

Here is the call graph for this function:

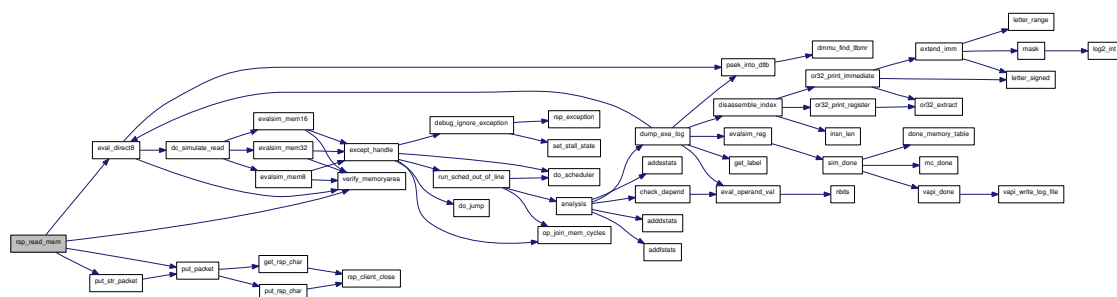

### 6.83.3.29 static void rsp\_read\_reg (struct rsp\_buf \* buf) [static]

Read a single register

The registers follow the GDB sequence for OR1K: GPR0 through GPR31, PC (i.e. SPR NPC) and SR (i.e. SPR SR). The register is returned as a sequence of bytes in target endian order.

Each byte is packed as a pair of hex digits.

**Parameters:**

← *buf* The original packet request. Reused for the reply.

Here is the call graph for this function:

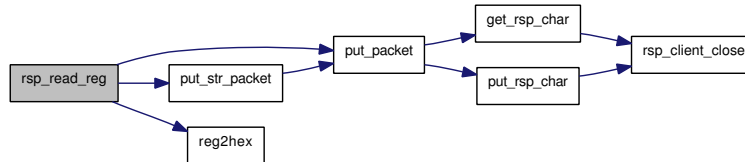

### 6.83.3.30 static void rsp\_remove\_matchpoint (struct rsp\_buf \* buf) [static]

Handle a RSP remove breakpoint or matchpoint request

For now only memory breakpoints are implemented, which are implemented by substituting a breakpoint at the specified address. The implementation must cope with the possibility of duplicate packets.

**Todo**

This doesn't work with icache/immu yet

**Parameters:**

← *buf* The command received

Here is the call graph for this function:

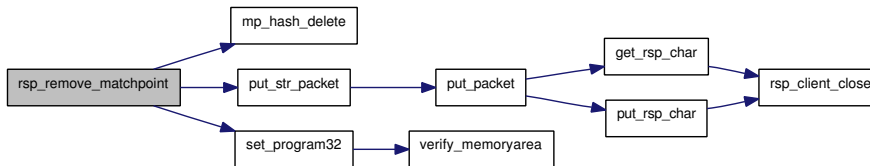

### 6.83.3.31 static void rsp\_report\_exception () [static]

Send a packet acknowledging an exception has occurred

This is only called if there is a client FD to talk to

Here is the call graph for this function:

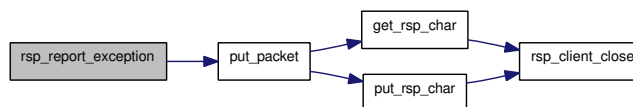

**6.83.3.32** `static void rsp_restart ()` [static]

Handle a RSP restart request

For now we just put the program counter back to the one used with the last vRun request. There is no point in uninstalling the processor, since we'll never get control back.

Here is the call graph for this function:

**6.83.3.33** `static void rsp_set (struct rsp_buf * buf)` [static]

Handle a RSP set request

**Parameters:**

← *buf* The request

Here is the call graph for this function:

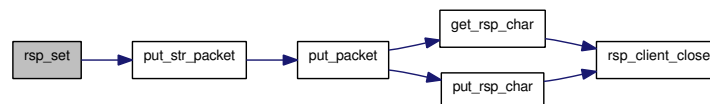
**6.83.3.34** `static void rsp_step (struct rsp_buf * buf)` [static]

Handle a RSP step request

Parse the command to see if there is an address. Uses the underlying generic step function, with EXCEPT\_NONE.

**Parameters:**

← *buf* The full step packet

Here is the call graph for this function:

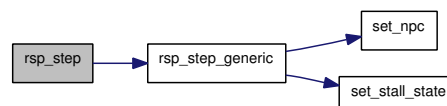
**6.83.3.35** `static void rsp_step_generic (unsigned long int addr, unsigned long int except)` [static]

Generic processing of a step request

The signal may be EXCEPT\_NONE if there is no exception to be handled. Currently the exception is ignored.

The single step flag is set in the debug registers and then the processor is unstalled.

**Parameters:**

- ← *addr* Address from which to step
- ← *except* The exception to use (if any)

Here is the call graph for this function:

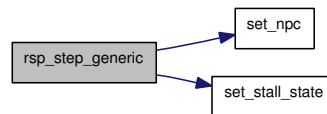

**6.83.3.36** `static void rsp_step_with_signal (struct rsp_buf * buf)` [static]

Handle a RSP step with signal request

Currently null. Will use the underlying generic step function.

**Parameters:**

- ← *buf* The full step with signal packet

**6.83.3.37** `static int rsp_unescape (char * data, int len)` [static]

"Unescape" RSP binary data

'#', '\$' and '}' are escaped by preceding them by '}' and oring with 0x20.

This function reverses that, modifying the data in place.

**Parameters:**

- ← *data* The array of bytes to convert [in] *len* The number of bytes to be converted

**Returns:**

- The number of bytes AFTER conversion

**6.83.3.38** `static void rsp_vpkt (struct rsp_buf * buf)` [static]

Handle a RSP 'v' packet

These are commands associated with executing the code on the target

**Parameters:**

- ← *buf* The request

Here is the call graph for this function:

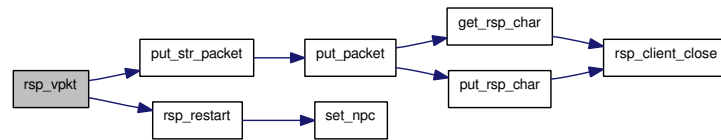

### 6.83.3.39 static void rsp\_write\_all\_regs (struct rsp\_buf \* buf) [static]

Handle a RSP write all registers request

The registers follow the GDB sequence for OR1K: GPR0 through GPR31, PPC (i.e. SPR PPC), NPC (i.e. SPR NPC) and SR (i.e. SPR SR). Each register is supplied as a sequence of bytes in target endian order.

Each byte is packed as a pair of hex digits.

#### Todo

There is no error checking at present. Non-hex chars will generate a warning message, but there is no other check that the right amount of data is present. The result is always "OK".

#### Parameters:

← *buf* The original packet request.

Here is the call graph for this function:

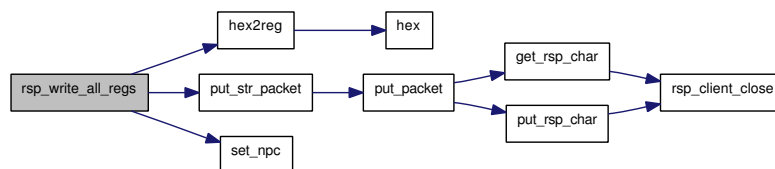

### 6.83.3.40 static void rsp\_write\_mem (struct rsp\_buf \* buf) [static]

Handle a RSP write memory (symbolic) request

Syntax is:

m<addr>,<length>:<data>

The data is the bytes, lowest address first, encoded as pairs of hex digits.

The length given is the number of bytes to be written.

#### Note:

This function reuses buf, so trashes the original command.

#### Parameters:

← *buf* The command received

Here is the call graph for this function:

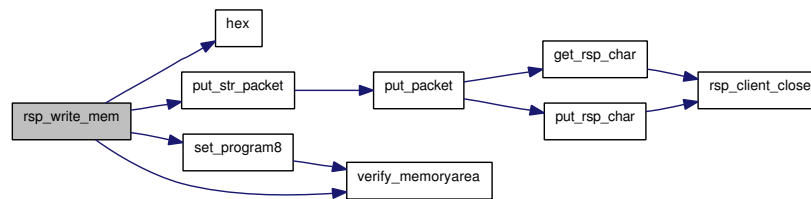

#### 6.83.3.41 static void rsp\_write\_mem\_bin (struct rsp\_buf \* buf) [static]

Handle a RSP write memory (binary) request

Syntax is:

X<addr>,<length>:

Followed by the specified number of bytes as raw binary. Response should be "OK" if all copied OK, E<nn> if error <nn> has occurred.

The length given is the number of bytes to be written. However the number of data bytes may be greater, since '#', '\$' and '}' are escaped by preceding them by '}' and oring with 0x20.

#### Parameters:

← *buf* The command received

Here is the call graph for this function:

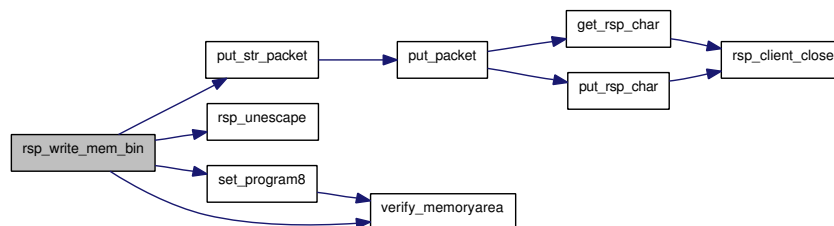

#### 6.83.3.42 static void rsp\_write\_reg (struct rsp\_buf \* buf) [static]

Write a single register

The registers follow the GDB sequence for OR1K: GPR0 through GPR31, PC (i.e. SPR NPC) and SR (i.e. SPR SR). The register is specified as a sequence of bytes in target endian order.

Each byte is packed as a pair of hex digits.

#### Parameters:

← *buf* The original packet request.

Here is the call graph for this function:

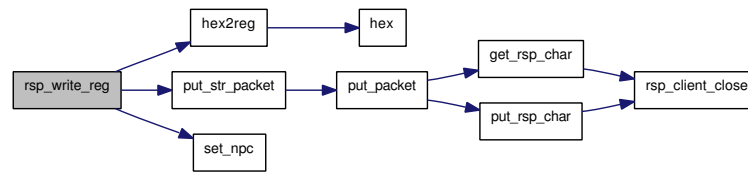

### 6.83.3.43 static void set\_npc (unsigned long int addr) [static]

Set the program counter

This sets the value in the NPC SPR. Not completely trivial, since this is actually cached in [cpu\\_state.pc](#). Any reset of the NPC also involves clearing the delay state and setting the pnext global.

Only actually do this if the requested address is different to the current NPC (avoids clearing the delay pipe).

#### Parameters:

← *addr* The address to use

## 6.83.4 Variable Documentation

### 6.83.4.1 int client\_fd

FD for talking to GDB

### 6.83.4.2 int client\_waiting

Is client waiting a response?

### 6.83.4.3 const char hexchars[] = "0123456789abcdef" [static]

String to map hex digits to chars

### 6.83.4.4 struct mp\_entry\* mp\_hash[MP\_HASH\_SIZE]

Matchpoint hash table

### 6.83.4.5 int proto\_num

Number of the protocol used

### 6.83.4.6 struct { ... } rsp [static]

Central data for the RSP connection

**6.83.4.7 int sigval**

GDB signal for any exception

**6.83.4.8 unsigned long int start\_addr**

Start of last run



## 6.84 debug/rsp-server.h File Reference

This graph shows which files directly or indirectly include this file:

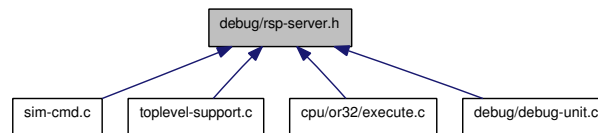

### Functions

- void [rsp\\_init](#) ()
- void [handle\\_rsp](#) ()
- void [rsp\\_exception](#) (unsigned long int except)

#### 6.84.1 Function Documentation

##### 6.84.1.1 void [handle\\_rsp](#) ()

Look for action on RSP

This function is called when the processor has stalled, which, except for initialization, must be due to an interrupt.

If we have no RSP client, we get one. We can make no progress until the client is available.

Then if the cause is an exception following a step or continue command, and the exception not been notified to GDB, a packet reporting the cause of the exception is sent.

The next client request is then processed.

Here is the call graph for this function:

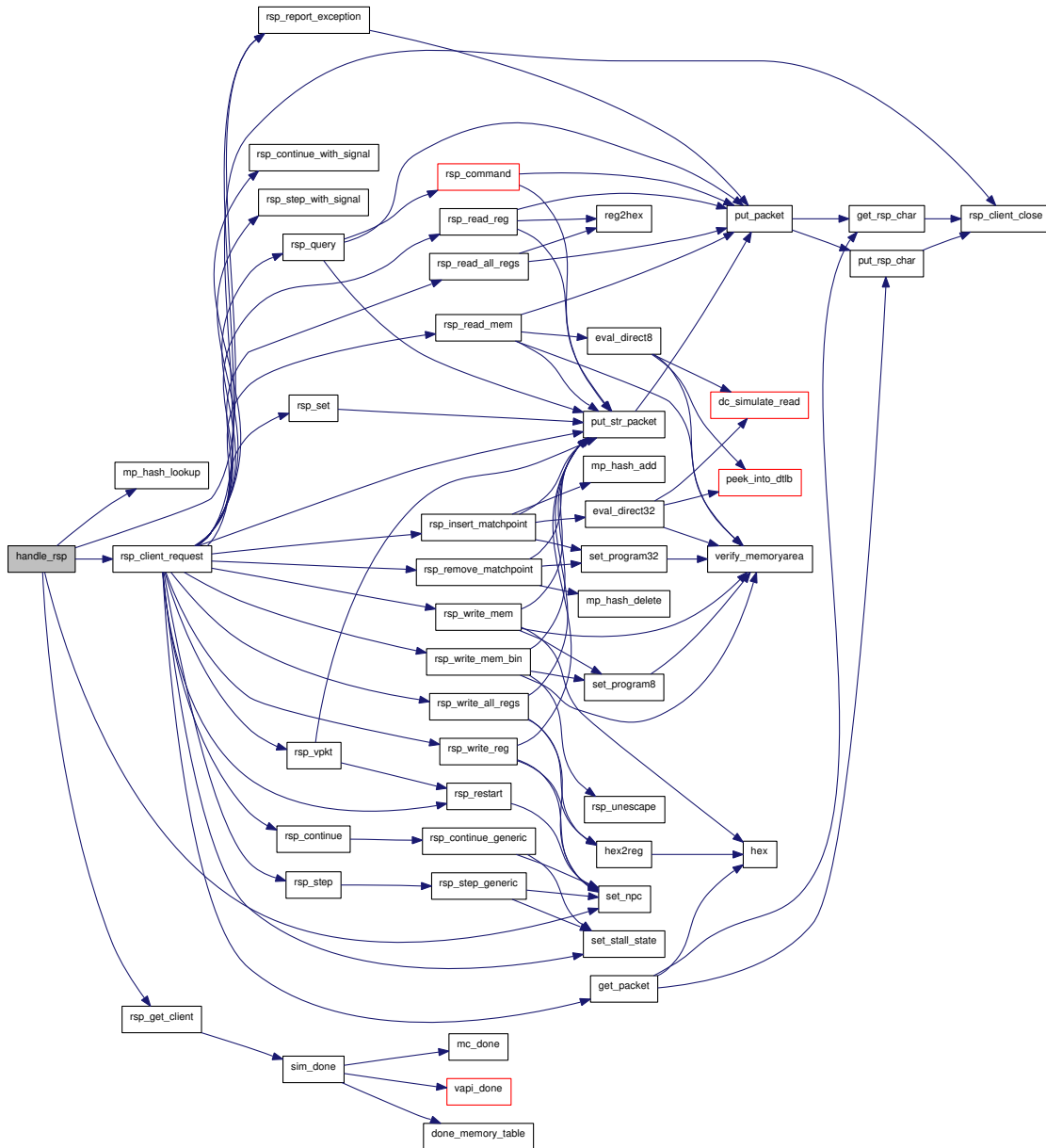

### 6.84.1.2 void rsp\_exception (unsigned long int except)

Note an exception for future processing

The simulator has encountered an exception. Record it here, so that a future call to handle\_exception will report it back to the client. The signal is supplied in Or1ksim form and recorded in GDB form.

We flag up a warning if an exception is already pending, and ignore the earlier exception.

#### Parameters:

← *except* The exception (Or1ksim form)

### 6.84.1.3 void rsp\_init ()

Initialize the Remote Serial Protocol connection

Set up the central data structures.

Here is the call graph for this function:



## 6.85 libtoplevel.c File Reference

```
#include "config.h"
#include <stdlib.h>
#include <unistd.h>
#include <signal.h>
#include "or1ksim.h"
#include "sim-config.h"
#include "toplevel-support.h"
#include "sched.h"
#include "execute.h"
#include "pic.h"
```

Include dependency graph for libtoplevel.c:

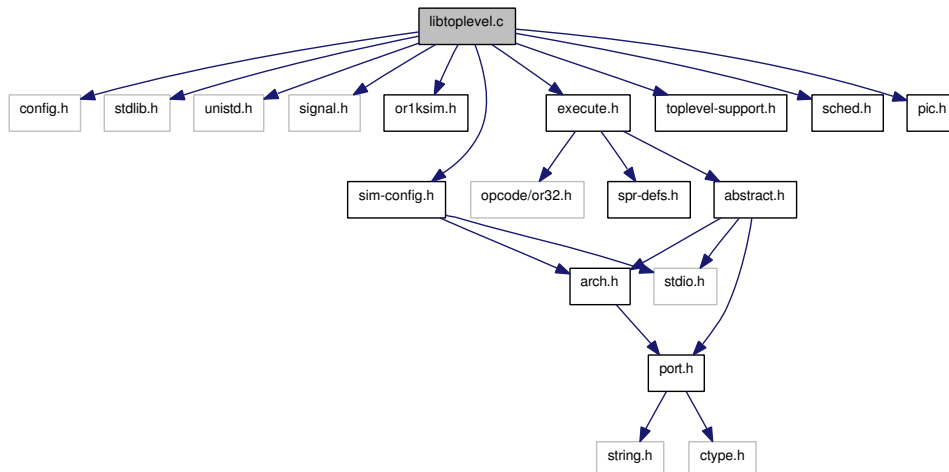

## Functions

- `int or1ksim_init` (const char \*config\_file, const char \*image\_file, void \*class\_ptr, unsigned long int(\*upr)(void \*class\_ptr, unsigned long int addr, unsigned long int mask), void(\*upw)(void \*class\_ptr, unsigned long int addr, unsigned long int mask, unsigned long int wdata))
- `int or1ksim_run` (double duration)
- `void or1ksim_reset_duration` (double duration)
- static double `internal_or1ksim_time` ()
- `void or1ksim_set_time_point` ()
- `double or1ksim_get_time_period` ()
- `int or1ksim_is_le` ()
- `unsigned long int or1ksim_clock_rate` ()
- `void or1ksim_interrupt` (int i)
- `void or1ksim_interrupt_set` (int i)
- `void or1ksim_interrupt_clear` (int i)

## 6.85.1 Function Documentation

### 6.85.1.1 static double internal\_or1ksim\_time () [static]

Return time executed so far

Internal utility to return the time executed so far. Note that this is a re-entrant routine.

#### Returns:

Time executed so far in seconds

### 6.85.1.2 unsigned long int or1ksim\_clock\_rate ()

Return the clock rate

Value is part of the configuration

#### Returns:

Clock rate in Hz.

### 6.85.1.3 double or1ksim\_get\_time\_period ()

Return the time since the time point was set

Get the value from the internal parameter

Here is the call graph for this function:

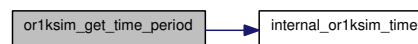

### 6.85.1.4 int or1ksim\_init (const char \* *config\_file*, const char \* *image\_file*, void \* *class\_ptr*, unsigned long int(\*) (void \* *class\_ptr*, unsigned long int *addr*, unsigned long int *mask*) *upr*, void(\*) (void \* *class\_ptr*, unsigned long int *addr*, unsigned long int *mask*, unsigned long int *wdata*) *upw*)

Initialize the simulator.

Allows specification of an (optional) [config](#) file and an image file. Builds up dummy argc/argv to pass to the existing argument parser.

#### Parameters:

- ← *config\_file* Or1ksim configuration file name
- ← *image\_file* The program image to execute
- ← *class\_ptr* Pointer to a C++ class instance (for use when called by C++)
- ← *upr* Upcall routine for reads
- ← *upw* Upcall routine for writes

**Returns:**

0 on success and an error code on failure

Here is the call graph for this function:

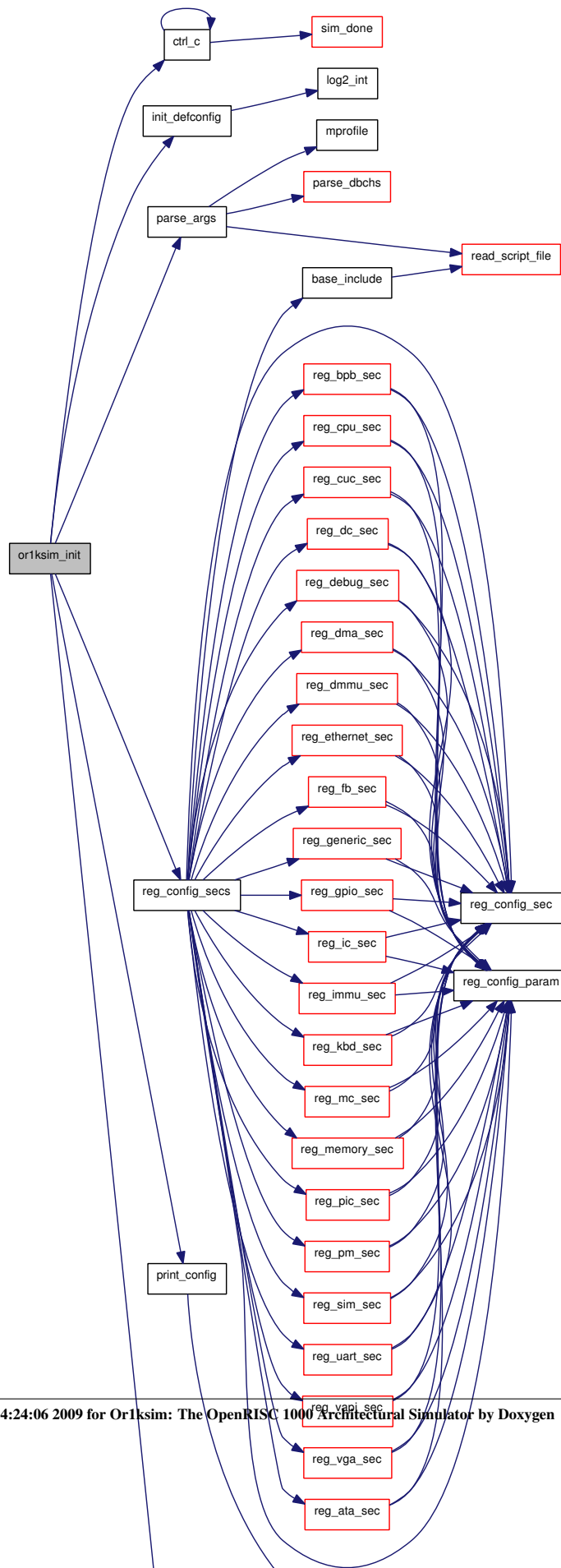

**6.85.1.5 void or1ksim\_interrupt (int *i*)**

Trigger an edge triggered interrupt

This function is appropriate for edge triggered interrupts, which are taken and then immediately cleared.

**Note:**

There is no check that the specified interrupt number is reasonable (i.e.  $\leq 31$ ).

**Parameters:**

← *i* The interrupt number

**6.85.1.6 void or1ksim\_interrupt\_clear (int *i*)**

Clear a level triggered interrupt

This function is appropriate for level triggered interrupts, which must be explicitly set first in a separate call.

**Note:**

There is no check that the specified interrupt number is reasonable (i.e.  $\leq 31$ ).

**Parameters:**

← *i* The interrupt number to clear

**6.85.1.7 void or1ksim\_interrupt\_set (int *i*)**

Set a level triggered interrupt

This function is appropriate for level triggered interrupts, which must be explicitly cleared in a separate call.

**Note:**

There is no check that the specified interrupt number is reasonable (i.e.  $\leq 31$ ).

**Parameters:**

← *i* The interrupt number to set

**6.85.1.8 int or1ksim\_is\_le ()**

Return the endianism of the model

Note that this is a re-entrant routine.

**Returns:**

1 if the model is little endian, 0 otherwise.





Here is the call graph for this function:

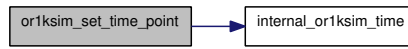

## **6.86 mainpage File Reference**

### **6.86.1 Detailed Description**

## 6.87 mmu/dmmu.c File Reference

```
#include "config.h"
#include "port.h"
#include <stdlib.h>
#include "dmmu.h"
#include "sim-config.h"
#include "arch.h"
#include "execute.h"
#include "spr-defs.h"
#include "stats.h"
#include "except.h"
#include "sprs.h"
#include "misc.h"
#include "sim-cmd.h"
```

Include dependency graph for dmmu.c:

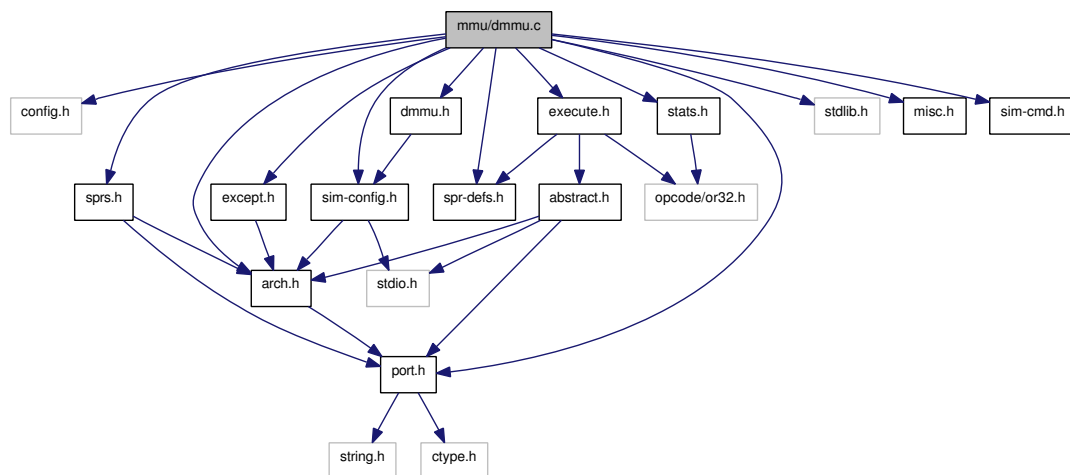

## Functions

- static `uorreg_t * dmmu_find_tlbmr (oraddr_t virtaddr, uorreg_t **dtlbmr_lru, struct dmmu *dmmu)`
- `oraddr_t dmmu_translate (oraddr_t virtaddr, int write_access)`
- `oraddr_t peek_into_dtlb (oraddr_t virtaddr, int write_access, int through_dc)`
- static void `dtlb_status (void *dat)`
- static void `dmmu_enabled (union param_val val, void *dat)`
- static void `dmmu_nsets (union param_val val, void *dat)`
- static void `dmmu_nways (union param_val val, void *dat)`
- static void `dmmu_pagesize (union param_val val, void *dat)`
- static void `dmmu_entsize (union param_val val, void *dat)`
- static void `dmmu_ustates (union param_val val, void *dat)`

- static void [dmmu\\_missdelay](#) (union [param\\_val](#) val, void \*dat)
- static void [dmmu\\_hitdelay](#) (union [param\\_val](#) val, void \*dat)
- static void \* [dmmu\\_start\\_sec](#) ()
- static void [dmmu\\_end\\_sec](#) (void \*dat)
- void [reg\\_dmmu\\_sec](#) (void)

## Variables

- struct [dmmu](#) \* [dmmu\\_state](#)

## 6.87.1 Function Documentation

### 6.87.1.1 static void [dmmu\\_enabled](#) (union [param\\_val](#) val, void \* dat) [static]

Enable or disable the DMMU

Set the corresponding field in the UPR

#### Parameters:

← *val* The value to use

← *dat* The [config](#) data structure

### 6.87.1.2 static void [dmmu\\_end\\_sec](#) (void \* dat) [static]

Here is the call graph for this function:

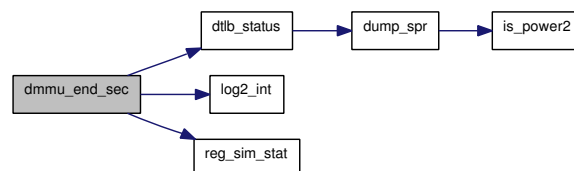

### 6.87.1.3 static void [dmmu\\_entsize](#) (union [param\\_val](#) val, void \* dat) [static]

Set the DMMU entry size

Value must be a power of 2. Ignore other values with a warning

#### Parameters:

← *val* The value to use

← *dat* The [config](#) data structure

Here is the call graph for this function:

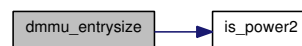

**6.87.1.4** `static uorreg_t* dmmu_find_tlbmr (oraddr_t virtaddr, uorreg_t** dtlbmr_lru, struct dmmu * dmmu)` [static]

**6.87.1.5** `static void dmmu_hitdelay (union param_val val, void * dat)` [static]

**6.87.1.6** `static void dmmu_missdelay (union param_val val, void * dat)` [static]

**6.87.1.7** `static void dmmu_nsets (union param_val val, void * dat)` [static]

Set the number of DMMU sets

Value must be a power of 2  $\leq 256$ . Ignore any other values with a warning. Set the corresponding DMMU configuration flags.

**Parameters:**

← *val* The value to use

← *dat* The `config` data structure

Here is the call graph for this function:

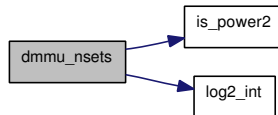

**6.87.1.8** `static void dmmu_nways (union param_val val, void * dat)` [static]

Set the number of DMMU ways

Value must be in the range 1-4. Ignore other values with a warning. Set the corresponding DMMU configuration flags.

**Parameters:**

← *val* The value to use

← *dat* The `config` data structure

**6.87.1.9** `static void dmmu_pagesize (union param_val val, void * dat)` [static]

Set the DMMU page size

Value must be a power of 2. Ignore other values with a warning

**Parameters:**

← *val* The value to use

← *dat* The `config` data structure

Here is the call graph for this function:

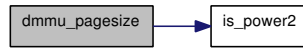

### 6.87.1.10 static void\* dmmu\_start\_sec () [static]

Initialize a new DMMU configuration

ALL parameters are set explicitly to default values. Corresponding SPR flags are set as appropriate.

#### Returns:

The new memory configuration data structure

Here is the call graph for this function:



### 6.87.1.11 oraddr\_t dmmu\_translate (oraddr\_t virtaddr, int write\_access)

Here is the call graph for this function:

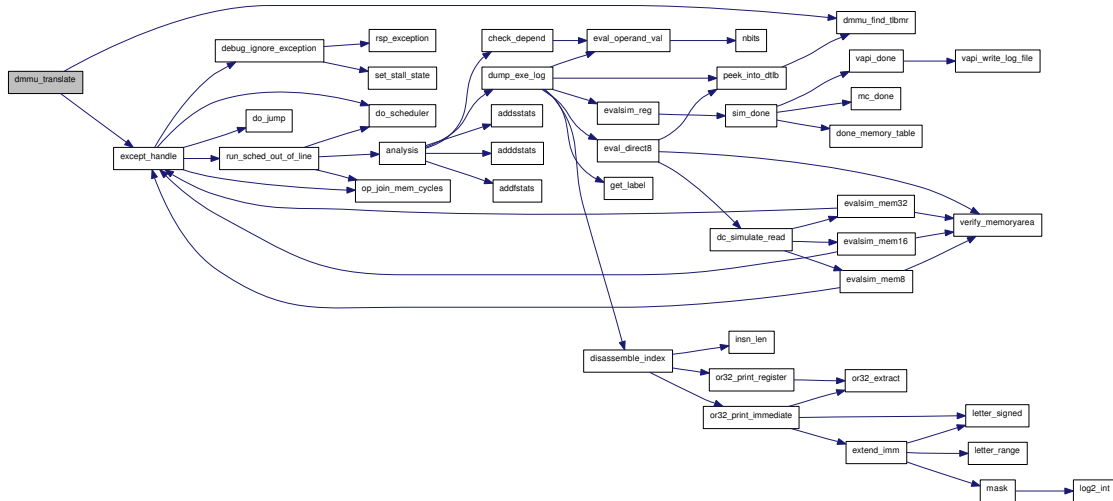

### 6.87.1.12 static void dmmu\_ustates (union param\_val val, void \* dat) [static]

Set the number of DMMU usage states

Value must be 2, 3 or 4. Ignore other values with a warning

**Parameters:**

- ← *val* The value to use
- ← *dat* The `config` data structure

**6.87.1.13 static void dtlb\_status (void \* dat) [static]**

Here is the call graph for this function:

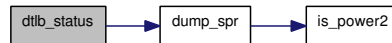
**6.87.1.14 oraddr\_t peek\_into\_dtlb (oraddr\_t virtaddr, int write\_access, int through\_dc)**

Here is the call graph for this function:

**6.87.1.15 void reg\_dmmu\_sec (void)**

Here is the call graph for this function:

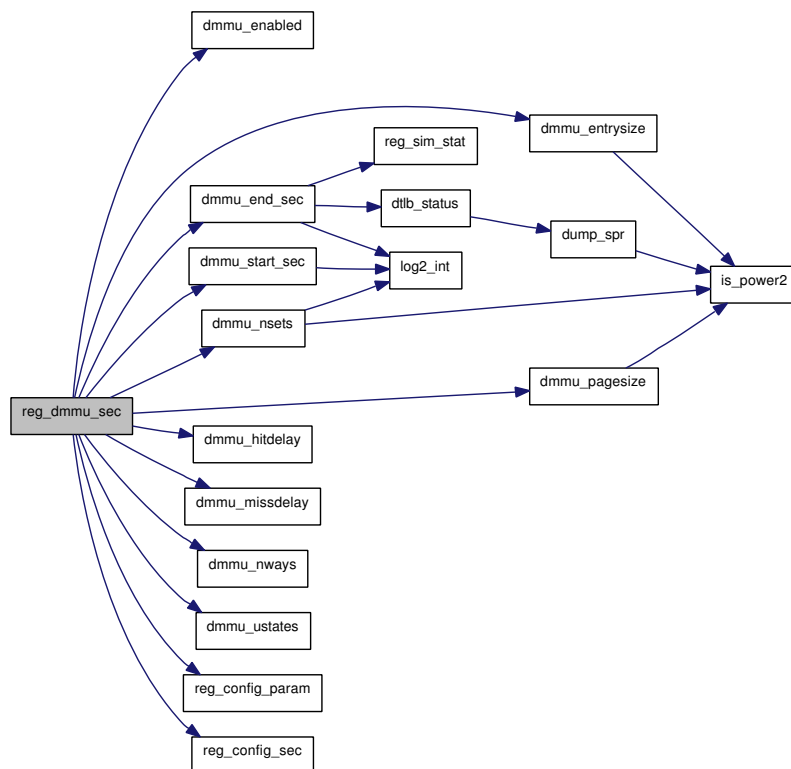



## 6.87.2 Variable Documentation

### 6.87.2.1 struct dmmu\* dmmu\_state

## 6.88 mmu/dmmu.h File Reference

```
#include "sim-config.h"
```

Include dependency graph for dmmu.h:

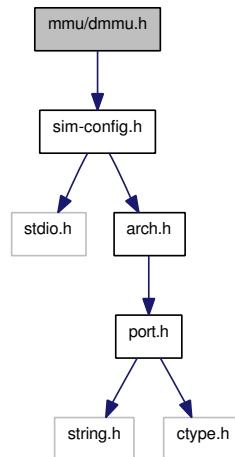

This graph shows which files directly or indirectly include this file:

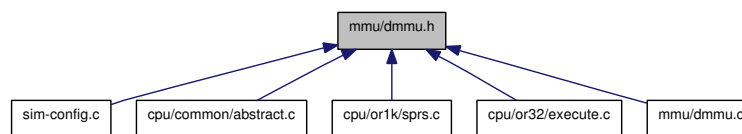

### Data Structures

- struct [dmmu](#)

### Defines

- #define [DADDR\\_PAGE](#)(addr) ((addr) & [dmmu\\_state](#) → page\_mask)

### Functions

- [oraddr\\_t dmmu\\_translate](#) ([oraddr\\_t](#) virtaddr, int write\_access)
- [oraddr\\_t dmmu\\_simulate\\_tlb](#) ([oraddr\\_t](#) virtaddr, int write\_access)
- [oraddr\\_t peek\\_into\\_dtlb](#) ([oraddr\\_t](#) virtaddr, int write\_access, int through\_dc)
- void [reg\\_dmmu\\_sec](#) ()

### Variables

- struct [dmmu](#) \* [dmmu\\_state](#)

## 6.88.1 Define Documentation

6.88.1.1 `#define DADDR_PAGE(addr) ((addr) & dmmu_state → page_mask)`

## 6.88.2 Function Documentation

6.88.2.1 `oraddr_t dmmu_simulate_tlb (oraddr_t virtaddr, int write_access)`

6.88.2.2 `oraddr_t dmmu_translate (oraddr_t virtaddr, int write_access)`

Here is the call graph for this function:

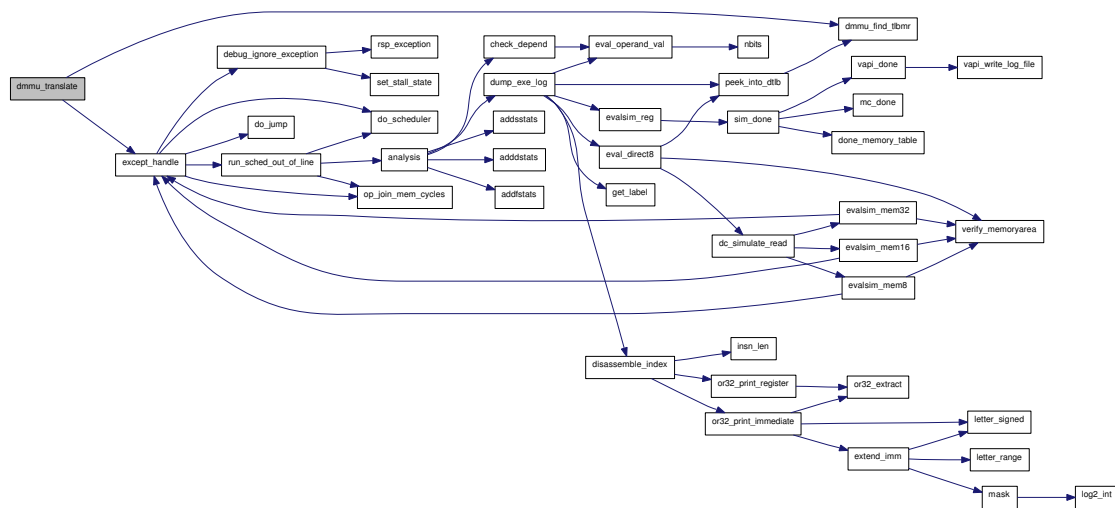

6.88.2.3 `oraddr_t peek_into_dtlb (oraddr_t virtaddr, int write_access, int through_dc)`

Here is the call graph for this function:



### 6.88.2.4 void reg\_dmmu\_sec ()

Here is the call graph for this function:

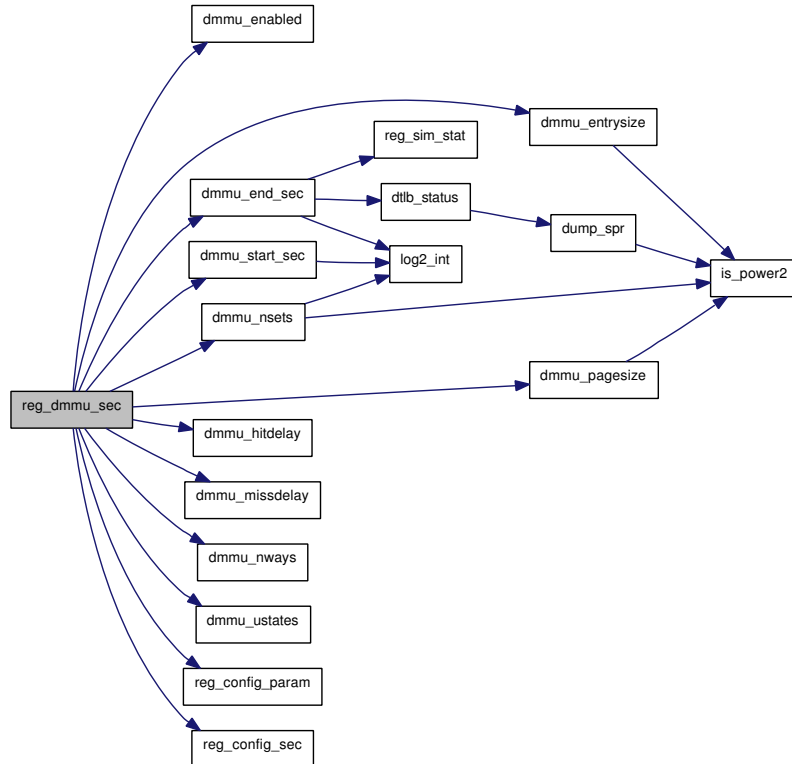

## 6.88.3 Variable Documentation

### 6.88.3.1 struct dmmu\* dmmu\_state

## 6.89 mmu/immu.c File Reference

```
#include "config.h"
#include <stdlib.h>
#include "immu.h"
#include "sim-config.h"
#include "execute.h"
#include "stats.h"
#include "except.h"
#include "spr-dump.h"
#include "misc.h"
#include "sim-cmd.h"
```

Include dependency graph for immu.c:

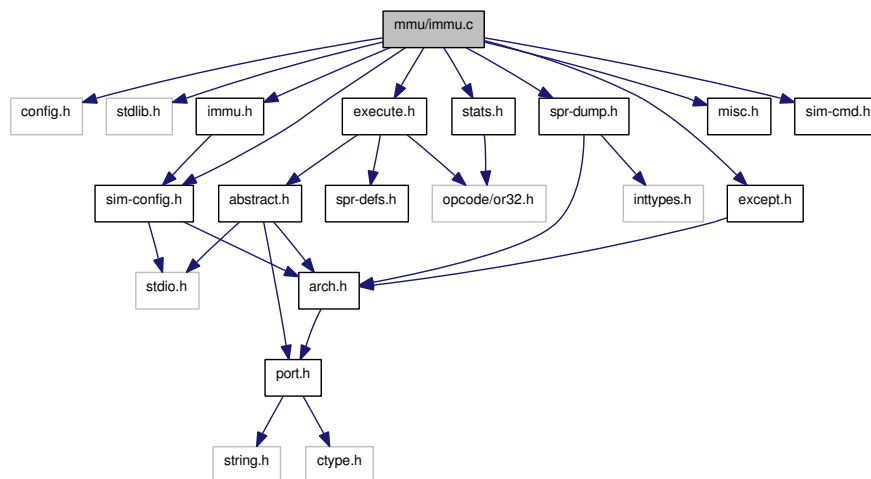

## Functions

- static `uorreg_t * immu_find_tlbmr (oraddr_t virtaddr, uorreg_t **itlbmr_lru, struct immu *immu)`
- `oraddr_t immu_translate (oraddr_t virtaddr)`
- `oraddr_t peek_into_itlb (oraddr_t virtaddr)`
- static void `itlb_status (void *dat)`
- static void `immu_enabled (union param_val val, void *dat)`
- static void `immu_nsets (union param_val val, void *dat)`
- static void `immu_nways (union param_val val, void *dat)`
- static void `immu_pagesize (union param_val val, void *dat)`
- static void `immu_entsize (union param_val val, void *dat)`
- static void `immu_ustates (union param_val val, void *dat)`
- static void `immu_missdelay (union param_val val, void *dat)`
- static void `immu_hitdelay (union param_val val, void *dat)`
- static void `* immu_start_sec ()`
- static void `immu_end_sec (void *dat)`
- void `reg_immu_sec (void)`

## Variables

- struct `immu` \* `immu_state`

## 6.89.1 Function Documentation

### 6.89.1.1 `static void immu_enabled (union param_val val, void * dat) [static]`

Enable or disable the IMMU

Set the corresponding field in the UPR

#### Parameters:

← *val* The value to use

← *dat* The `config` data structure

### 6.89.1.2 `static void immu_end_sec (void * dat) [static]`

Here is the call graph for this function:

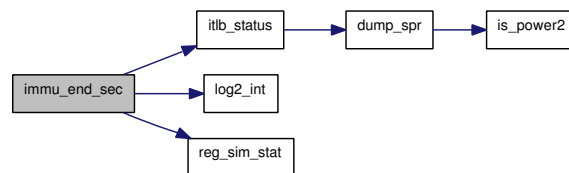

### 6.89.1.3 `static void immu_entsize (union param_val val, void * dat) [static]`

Set the IMMU entry size

Value must be a power of 2. Ignore other values with a warning

#### Parameters:

← *val* The value to use

← *dat* The `config` data structure

Here is the call graph for this function:

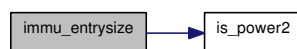

**6.89.1.4** `static uorreg_t* immu_find_tlbmr (oraddr_t virtaddr, uorreg_t** tlbmr_lru, struct immu * immu)` [static]

**6.89.1.5** `static void immu_hitdelay (union param_val val, void * dat)` [static]

**6.89.1.6** `static void immu_missdelay (union param_val val, void * dat)` [static]

**6.89.1.7** `static void immu_nsets (union param_val val, void * dat)` [static]

Set the number of DMMU sets

Value must be a power of 2 <= 256. Ignore any other values with a warning. Set the corresponding IMMU configuration flags.

**Parameters:**

← *val* The value to use

← *dat* The `config` data structure

Here is the call graph for this function:

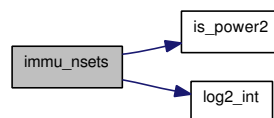

**6.89.1.8** `static void immu_nways (union param_val val, void * dat)` [static]

Set the number of IMMU ways

Value must be in the range 1-4. Ignore other values with a warning. Set the corresponding IMMU configuration flags.

**Parameters:**

← *val* The value to use

← *dat* The `config` data structure

**6.89.1.9** `static void immu_pagesize (union param_val val, void * dat)` [static]

Set the IMMU page size

Value must be a power of 2. Ignore other values with a warning

**Parameters:**

← *val* The value to use

← *dat* The `config` data structure

Here is the call graph for this function:

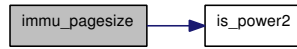

#### 6.89.1.10 static void\* immu\_start\_sec () [static]

Initialize a new DMMU configuration

ALL parameters are set explicitly to default values.

Here is the call graph for this function:



#### 6.89.1.11 oraddr\_t immu\_translate (oraddr\_t virtaddr)

Here is the call graph for this function:

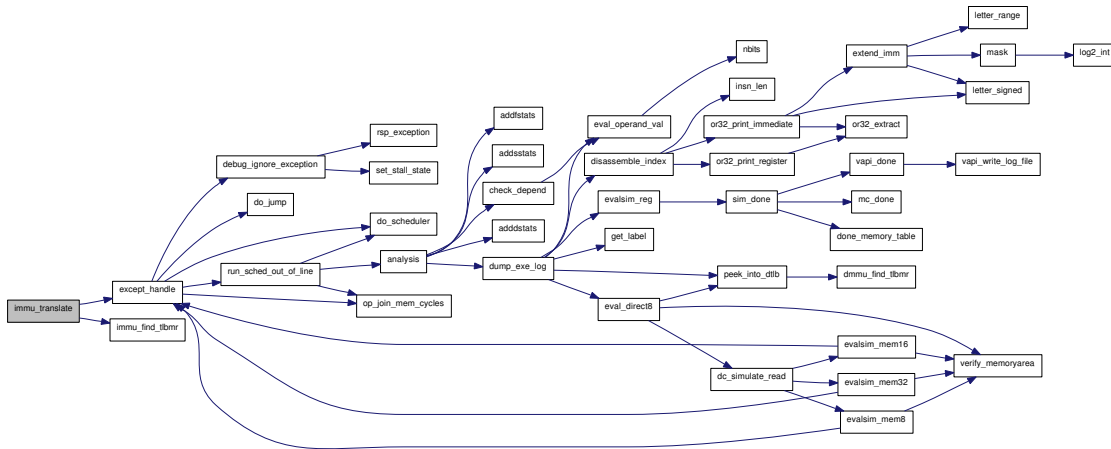

#### 6.89.1.12 static void immu\_ustates (union param\_val val, void \* dat) [static]

Set the number of IMMU usage states

Value must be 2, 3 or 4. Ignore other values with a warning

##### Parameters:

← *val* The value to use

← *dat* The `config` data structure



### 6.89.1.13 static void itlb\_status (void \* *dat*) [static]

Here is the call graph for this function:

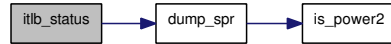

### 6.89.1.14 oraddr\_t peek\_into\_itlb (oraddr\_t *virtaddr*)

Here is the call graph for this function:



### 6.89.1.15 void reg\_immu\_sec (void)

Here is the call graph for this function:

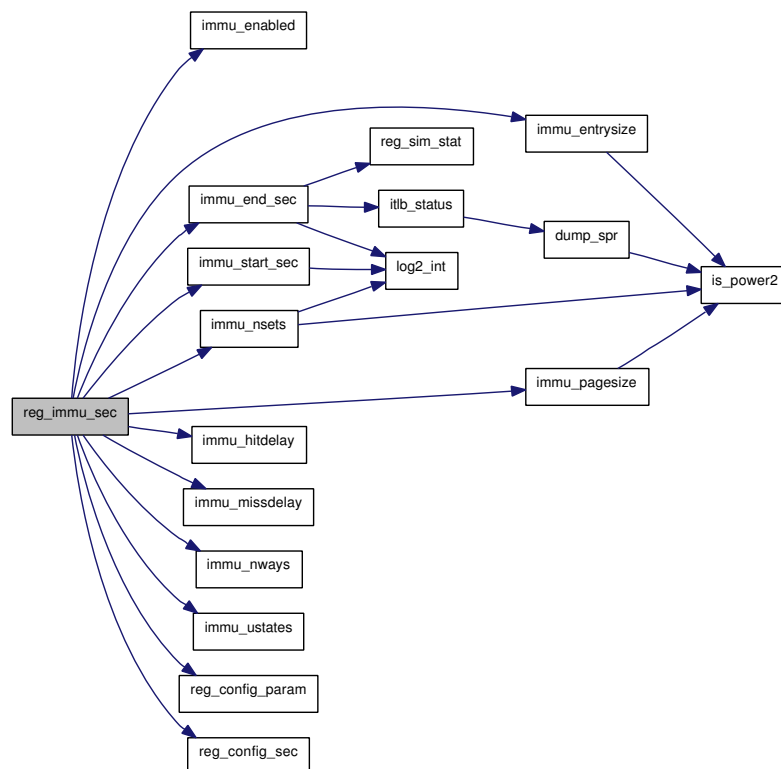

## 6.89.2 Variable Documentation

### 6.89.2.1 struct immu\* immu\_state

## 6.90 mmu/immu.h File Reference

```
#include "sim-config.h"
```

Include dependency graph for immu.h:

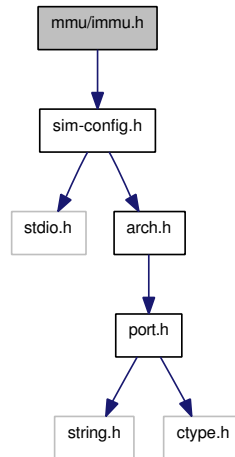

This graph shows which files directly or indirectly include this file:

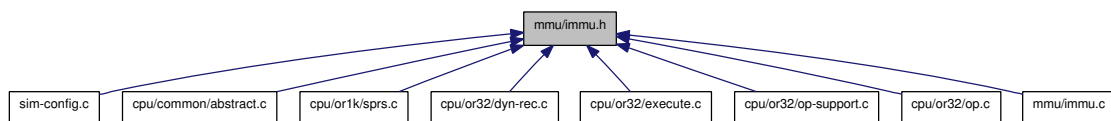

### Data Structures

- struct [immu](#)

### Defines

- #define [IADDR\\_PAGE](#)(addr) ((addr) & [immu\\_state](#) → page\_mask)

### Functions

- [oraddr\\_t immu\\_translate](#) ([oraddr\\_t](#) virtaddr)
- [oraddr\\_t immu\\_simulate\\_tlb](#) ([oraddr\\_t](#) virtaddr)
- [oraddr\\_t peek\\_into\\_itlb](#) ([oraddr\\_t](#) virtaddr)
- void [reg\\_immu\\_sec](#) ()

### Variables

- struct [immu](#) \* [immu\\_state](#)

## 6.90.1 Define Documentation

6.90.1.1 `#define IADDR_PAGE(addr) ((addr) & immu_state → page_mask)`

## 6.90.2 Function Documentation

6.90.2.1 `oraddr_t immu_simulate_tlb (oraddr_t virtaddr)`

6.90.2.2 `oraddr_t immu_translate (oraddr_t virtaddr)`

Here is the call graph for this function:

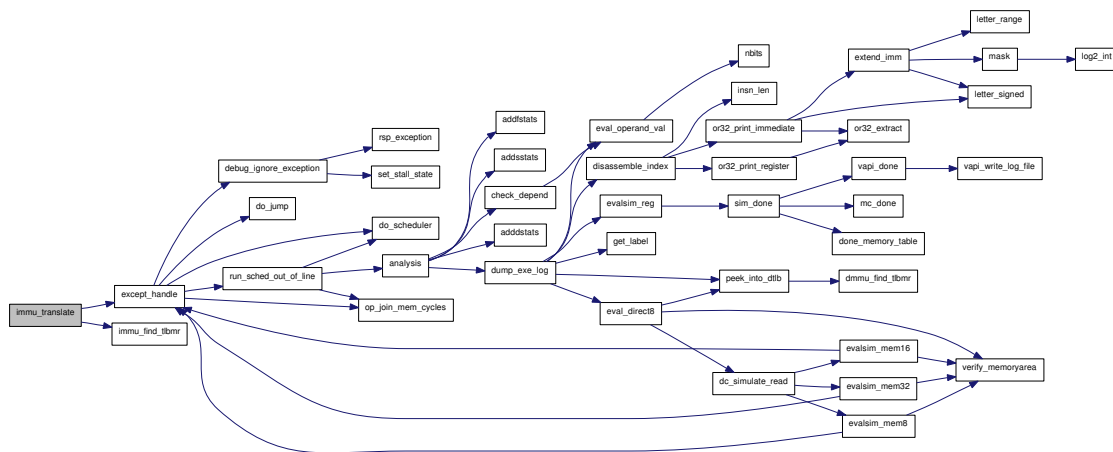

6.90.2.3 `oraddr_t peek_into_itlb (oraddr_t virtaddr)`

Here is the call graph for this function:



### 6.90.2.4 void reg\_immu\_sec ()

Here is the call graph for this function:

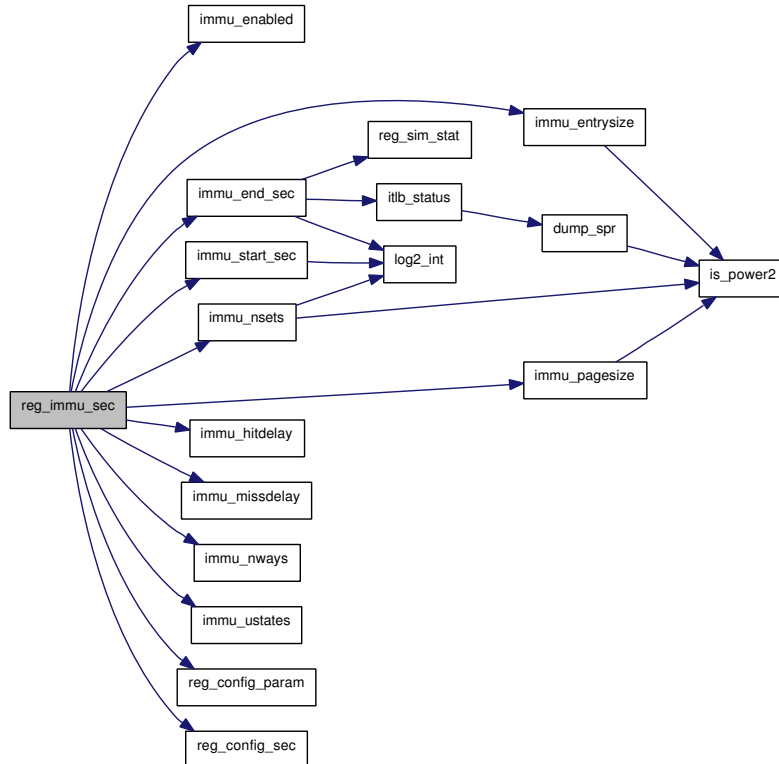

## 6.90.3 Variable Documentation

### 6.90.3.1 struct immu\* immu\_state

## 6.91 mprofiler.c File Reference

```
#include "config.h"
#include "port.h"
#include <stdlib.h>
#include <regex.h>
#include "mprofiler.h"
#include "sim-config.h"
#include "argtable2.h"
#include "support/profile.h"
```

Include dependency graph for mprofiler.c:

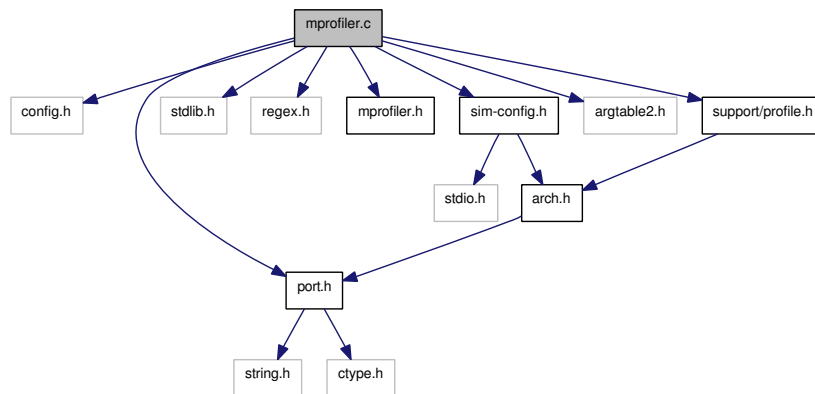

### Data Structures

- struct [memory\\_hash](#)

### Defines

- #define [MODE\\_DETAIL](#) 0
- #define [MODE\\_PRETTY](#) 1
- #define [MODE\\_ACCESS](#) 2
- #define [MODE\\_WIDTH](#) 3
- #define [BUF\\_SIZE](#) 256
- #define [HASH\\_SIZE](#) 0x10000
- #define [HASH\\_FUNC\(x\)](#) ((x) & 0xffff)

### Functions

- static void [hash\\_add](#) ([oraddr\\_t](#) addr, int index)
- static unsigned long [hash\\_get](#) ([oraddr\\_t](#) addr, int index)
- static void [init](#) ()
- static void [read\\_file](#) (FILE \*f, int mode)

- static int `nbits` (unsigned long a)
- static void `printout` (int mode)
- int `main_mprofiler` (int argc, char \*argv[], int just\_help)

## Variables

- static struct `memory_hash` \* `hash` [HASH\_SIZE]
- static int `group_bits` = 2
- static `oraddr_t` `start_addr` = 0
- static `oraddr_t` `end_addr` = 0xffffffff
- static FILE \* `fprof` = 0

## 6.91.1 Define Documentation

6.91.1.1 `#define BUF_SIZE 256`

6.91.1.2 `#define HASH_FUNC(x) ((x) & 0xffff)`

6.91.1.3 `#define HASH_SIZE 0x10000`

6.91.1.4 `#define MODE_ACCESS 2`

6.91.1.5 `#define MODE_DETAIL 0`

6.91.1.6 `#define MODE_PRETTY 1`

6.91.1.7 `#define MODE_WIDTH 3`

## 6.91.2 Function Documentation

6.91.2.1 `static void hash_add (oraddr_t addr, int index)` [static]

6.91.2.2 `static unsigned long hash_get (oraddr_t addr, int index)` [static]

6.91.2.3 `static void init ()` [static]

6.91.2.4 `int main_mprofiler (int argc, char * argv[], int just_help)`

Parse the arguments for the profiling utility

Updated by Jeremy Bennett to use argtable2. Also has an option just to print help, for use with the CLI.

### Parameters:

- ← *argc* Number of command args
- ← *argv* Vector of the command args
- ← *just\_help* If 1 (true), ignore argc & argv and just print out the help message without parsing args

### Returns:

0 on success, 1 on failure

Here is the call graph for this function:

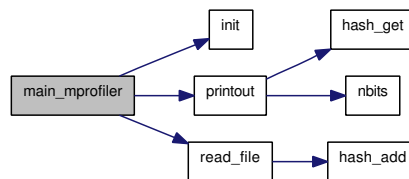

**6.91.2.5** `static int nbits (unsigned long a)` [static]

**6.91.2.6** `static void printout (int mode)` [static]

Here is the call graph for this function:

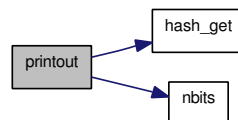

**6.91.2.7** `static void read_file (FILE *f, int mode)` [static]

Here is the call graph for this function:



## 6.91.3 Variable Documentation

**6.91.3.1** `oraddr_t end_addr = 0xffffffff` [static]

End address

**6.91.3.2** `FILE* fprof = 0` [static]

**6.91.3.3** `int group_bits = 2` [static]

Groups size – how much addresses should be joined together

**6.91.3.4** `struct memory_hash * hash[HASH_SIZE]` [static]

Hash table data structure

**6.91.3.5 oraddr\_t start\_addr = 0** [static]

Start address



## 6.92 mprofiler.h File Reference

This graph shows which files directly or indirectly include this file:

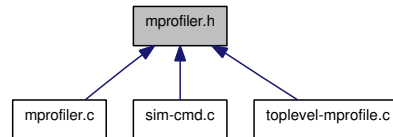

### Functions

- int [main\\_mprofiler](#) (int argc, char \*argv[], int just\_help)

### 6.92.1 Function Documentation

#### 6.92.1.1 int main\_mprofiler (int argc, char \* argv[], int just\_help)

Parse the arguments for the profiling utility

Updated by Jeremy Bennett to use argtable2. Also has an option just to print help, for use with the CLI.

#### Parameters:

- ← *argc* Number of command args
- ← *argv* Vector of the command args
- ← *just\_help* If 1 (true), ignore argc & argv and just print out the help message without parsing args

#### Returns:

- 0 on success, 1 on failure

Here is the call graph for this function:

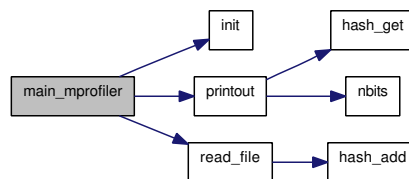

## 6.93 or1ksim.h File Reference

This graph shows which files directly or indirectly include this file:

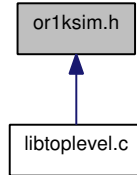

### Enumerations

- enum `or1ksim_rc` { `ORIKSIM_RC_OK`, `ORIKSIM_RC_BADINIT`, `ORIKSIM_RC_BRKPT` }

### Functions

- int `or1ksim_init` (const char \*config\_file, const char \*image\_file, void \*class\_ptr, unsigned long int(\*upr)(void \*class\_ptr, unsigned long intaddr, unsigned long intmask), void(\*upw)(void \*class\_ptr, unsigned long intaddr, unsigned long intmask, unsigned long intwdata))
- int `or1ksim_run` (double duration)
- void `or1ksim_reset_duration` (double duration)
- void `or1ksim_set_time_point` ()
- double `or1ksim_get_time_period` ()
- int `or1ksim_is_le` ()
- unsigned long int `or1ksim_clock_rate` ()
- void `or1ksim_interrupt` (int i)
- void `or1ksim_interrupt_set` (int i)
- void `or1ksim_interrupt_clear` (int i)

### 6.93.1 Enumeration Type Documentation

#### 6.93.1.1 enum `or1ksim_rc`

Enumerator:

*`ORIKSIM_RC_OK`*  
*`ORIKSIM_RC_BADINIT`*  
*`ORIKSIM_RC_BRKPT`*

### 6.93.2 Function Documentation

#### 6.93.2.1 unsigned long int `or1ksim_clock_rate` ()

Return the clock rate

Value is part of the configuration

Returns:

Clock rate in Hz.

### 6.93.2.2 double or1ksim\_get\_time\_period ()

Return the time since the time point was set

Get the value from the internal parameter

Here is the call graph for this function:



**6.93.2.3 int or1ksim\_init (const char \* *config\_file*, const char \* *image\_file*, void \* *class\_ptr*, unsigned long int(\*) (void \* *class\_ptr*, unsigned long intaddr, unsigned long intmask) *upr*, void(\*) (void \* *class\_ptr*, unsigned long intaddr, unsigned long intmask, unsigned long intwdata) *upw*)**

### 6.93.2.4 void or1ksim\_interrupt (int *i*)

Trigger an edge triggered interrupt

This function is appropriate for edge triggered interrupts, which are taken and then immediately cleared.

#### Note:

There is no check that the specified interrupt number is reasonable (i.e.  $\leq 31$ ).

#### Parameters:

← *i* The interrupt number

### 6.93.2.5 void or1ksim\_interrupt\_clear (int *i*)

Clear a level triggered interrupt

This function is appropriate for level triggered interrupts, which must be explicitly set first in a separate call.

#### Note:

There is no check that the specified interrupt number is reasonable (i.e.  $\leq 31$ ).

#### Parameters:

← *i* The interrupt number to clear

### 6.93.2.6 void or1ksim\_interrupt\_set (int *i*)

Set a level triggered interrupt

This function is appropriate for level triggered interrupts, which must be explicitly cleared in a separate call.

**Note:**

There is no check that the specified interrupt number is reasonable (i.e.  $\leq 31$ ).

**Parameters:**

← *i* The interrupt number to set

**6.93.2.7 int or1ksim\_is\_le ()**

Return the endianism of the model

Note that this is a re-entrant routine.

**Returns:**

1 if the model is little endian, 0 otherwise.

**6.93.2.8 void or1ksim\_reset\_duration (double duration)**

Reset the run-time simulation end point

Reset the time for which the simulation should run to the specified duration from NOW (i.e. NOT from when the run started).

**Parameters:**

← *duration* Time to run for in seconds

**6.93.2.9 int or1ksim\_run (double duration)**

Run the simulator

The argument is a time in seconds, which is converted to a number of cycles, if positive. A negative value means "run for ever".

The semantics are that the duration for which the run may occur may be changed mid-run by a call to [or1ksim\\_reset\\_duration\(\)](#). This is to allow for the upcalls to generic components adding time, and reducing the time permitted for ISS execution before synchronization of the parent SystemC wrapper.

This is over-ridden if the call was for a negative duration, which means run forever!

Uses a simplified version of the old main program loop. Returns success if the requested number of cycles were run and an error code otherwise.

**Parameters:**

← *duration* Time to execute for (seconds)

**Returns:**

OR1KSIM\_RC\_OK if we run to completion, OR1KSIM\_RC\_BRKPT if we hit a breakpoint (not clear how this can be set without CLI access)



## 6.94 peripheral/16450.c File Reference

```
#include "config.h"
#include "port.h"
#include <stdlib.h>
#include "sim-config.h"
#include "arch.h"
#include "pic.h"
#include "sched.h"
#include "vapi.h"
#include "channel.h"
#include "abstract.h"
#include "toplevel-support.h"
#include "sim-cmd.h"
```

Include dependency graph for 16450.c:

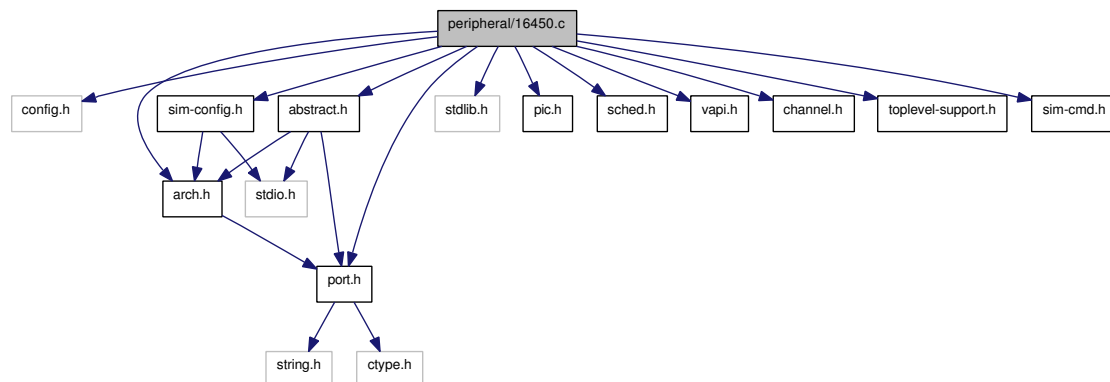

### Data Structures

- struct [dev\\_16450](#)

### Defines

- #define [MIN\(a, b\)](#) ((a) < (b) ? (a) : (b))
- #define [UART\\_ADDR\\_SPACE](#) 8
- #define [UART\\_MAX\\_FIFO\\_LEN](#) 16
- #define [MAX\\_SKEW](#) 1
- #define [UART\\_VAPI\\_BUF\\_LEN](#) 128
- #define [UART\\_CLOCK\\_DIVIDER](#) 16
- #define [UART\\_FGETC\\_SLOWDOWN](#) 100
- #define [UART\\_RXBUF](#) 0
- #define [UART\\_TXBUF](#) 0

- #define `UART_DLL` 0
- #define `UART_DLH` 1
- #define `UART_IER` 1
- #define `UART_IIR` 2
- #define `UART_FCR` 2
- #define `UART_LCR` 3
- #define `UART_MCR` 4
- #define `UART_LSR` 5
- #define `UART_MSR` 6
- #define `UART_SCR` 7
- #define `UART_VALID_LCR` 0xff
- #define `UART_VALID_LSR` 0xff
- #define `UART_VALID_IIR` 0x0f
- #define `UART_VALID_FCR` 0xc0
- #define `UART_VALID_IER` 0x0f
- #define `UART_VALID_MCR` 0x1f
- #define `UART_VALID_MSR` 0xff
- #define `UART_LCR_DLAB` 0x80
- #define `UART_LCR_SBC` 0x40
- #define `UART_LCR_SPAR` 0x20
- #define `UART_LCR_EPAR` 0x10
- #define `UART_LCR_PARITY` 0x08
- #define `UART_LCR_STOP` 0x04
- #define `UART_LCR_WLEN5` 0x00
- #define `UART_LCR_WLEN6` 0x01
- #define `UART_LCR_WLEN7` 0x02
- #define `UART_LCR_WLEN8` 0x03
- #define `UART_LCR_RESET` 0x03
- #define `UART_LSR_RXERR` 0x80
- #define `UART_LSR_TXSRE` 0x40
- #define `UART_LSR_TXBUFE` 0x20
- #define `UART_LSR_BREAK` 0x10
- #define `UART_LSR_FRAME` 0x08
- #define `UART_LSR_PARITY` 0x04
- #define `UART_LSR_OVRRUN` 0x02
- #define `UART_LSR_RDRDY` 0x01
- #define `UART_IIR_NO_INT` 0x01
- #define `UART_IIR_ID` 0x06
- #define `UART_IIR_MSI` 0x00
- #define `UART_IIR_THRI` 0x02
- #define `UART_IIR_RDI` 0x04
- #define `UART_IIR_RLSI` 0x06
- #define `UART_IIR_CTI` 0x0c
- #define `UART_FCR_FIE` 0x01
- #define `UART_FCR_RRXFI` 0x02
- #define `UART_FCR_RTXFI` 0x04
- #define `UART_FIFO_TRIGGER(x)`
- #define `UART_IER_MSI` 0x08
- #define `UART_IER_RLSI` 0x04
- #define `UART_IER_THRI` 0x02

- #define `UART_IER_RDI` 0x01
- #define `UART_MCR_LOOP` 0x10
- #define `UART_MCR_AUX2` 0x08
- #define `UART_MCR_AUX1` 0x04
- #define `UART_MCR_RTS` 0x02
- #define `UART_MCR_DTR` 0x01
- #define `UART_MSR_DCD` 0x80
- #define `UART_MSR_RI` 0x40
- #define `UART_MSR_DSR` 0x20
- #define `UART_MSR_CTS` 0x10
- #define `UART_MSR_DDCD` 0x08
- #define `UART_MSR_TERI` 0x04
- #define `UART_MSR_DDSR` 0x02
- #define `UART_MSR_DCTS` 0x01
- #define `UART_BREAK_COUNT` 1
- #define `UART_CHAR_TIMEOUT` 4

## Functions

- static void `uart_recv_break` (void \*dat)
- static void `uart_recv_char` (void \*dat)
- static void `uart_check_char` (void \*dat)
- static void `uart_sched_recv_check` (struct `dev_16450` \*uart)
- static void `uart_vapi_cmd` (void \*dat)
- static void `uart_clear_int` (struct `dev_16450` \*uart, int intr)
- static void `uart_tx_send` (void \*dat)
- static unsigned long `char_clks` (int dll, int dlh, int lcr)
- static void `uart_int_msi` (void \*dat)
- static void `uart_int_thri` (void \*dat)
- static void `uart_int_cti` (void \*dat)
- static void `uart_int_rdi` (void \*dat)
- static void `uart_int_rlsi` (void \*dat)
- static void `uart_check_rlsi` (void \*dat)
- static void `uart_check_rdi` (void \*dat)
- static void `uart_next_int` (struct `dev_16450` \*uart)
- static void `uart_loopback` (struct `dev_16450` \*uart)
- static void `send_char` (struct `dev_16450` \*uart, int bits\_send)
- void `uart_char_clock` (void \*dat)
- void `uart_send_break` (void \*dat)
- static void `uart_add_char` (struct `dev_16450` \*uart, int ch)
- static void `uart_recv_break_start` (void \*dat)
- static void `uart_recv_break_stop` (void \*dat)
- static void `uart_write_byte` (`oraddr_t` addr, `uint8_t` value, void \*dat)
- static `uint8_t` `uart_read_byte` (`oraddr_t` addr, void \*dat)
- static void `uart_vapi_read` (unsigned long id, unsigned long data, void \*dat)
- void `uart_reset` (void \*dat)
- void `uart_status` (void \*dat)
- static void `uart_baseaddr` (union `param_val` val, void \*dat)
- static void `uart_jitter` (union `param_val` val, void \*dat)
- static void `uart_irq` (union `param_val` val, void \*dat)



- static void `uart_16550` (union `param_val` val, void \*dat)
- static void `uart_channel` (union `param_val` val, void \*dat)
- static void `uart_newway` (union `param_val` val, void \*dat)
- static void `uart_vapi_id` (union `param_val` val, void \*dat)
- static void `uart_enabled` (union `param_val` val, void \*dat)
- static void \* `uart_sec_start` ()
- static void `uart_sec_end` (void \*dat)
- void `reg_uart_sec` (void)

## 6.94.1 Define Documentation

### 6.94.1.1 `#define MAX_SKEW 1`

max. clock skew in subclocks

### 6.94.1.2 `#define MIN(a, b) ((a) < (b) ? (a) : (b))`

### 6.94.1.3 `#define UART_ADDR_SPACE 8`

UART addr space size in bytes

### 6.94.1.4 `#define UART_BREAK_COUNT 1`

### 6.94.1.5 `#define UART_CHAR_TIMEOUT 4`

### 6.94.1.6 `#define UART_CLOCK_DIVIDER 16`

UART clock divider

### 6.94.1.7 `#define UART_DLH 1`

### 6.94.1.8 `#define UART_DLL 0`

### 6.94.1.9 `#define UART_FCR 2`

### 6.94.1.10 `#define UART_FCR_FIE 0x01`

### 6.94.1.11 `#define UART_FCR_RRXFI 0x02`

### 6.94.1.12 `#define UART_FCR_RTXFI 0x04`

### 6.94.1.13 `#define UART_FGETC_SLOWDOWN 100`

fgetc() slowdown factor

### 6.94.1.14 `#define UART_FIFO_TRIGGER(x)`

**Value:**

```
/* Trigger values for indexes 0..3 */\  
(x) == 0 ? 1\  
:(x) == 1 ? 4\  
:(x) == 2 ? 8\  
:(x) == 3 ? 14 : 0)
```



```
6.94.1.15 #define UART_IER 1
6.94.1.16 #define UART_IER_MSI 0x08
6.94.1.17 #define UART_IER_RDI 0x01
6.94.1.18 #define UART_IER_RLSI 0x04
6.94.1.19 #define UART_IER_THRI 0x02
6.94.1.20 #define UART_IIR 2
6.94.1.21 #define UART_IIR_CTI 0x0c
6.94.1.22 #define UART_IIR_ID 0x06
6.94.1.23 #define UART_IIR_MSI 0x00
6.94.1.24 #define UART_IIR_NO_INT 0x01
6.94.1.25 #define UART_IIR_RDI 0x04
6.94.1.26 #define UART_IIR_RLSI 0x06
6.94.1.27 #define UART_IIR_THRI 0x02
6.94.1.28 #define UART_LCR 3
6.94.1.29 #define UART_LCR_DLAB 0x80
6.94.1.30 #define UART_LCR_EPAR 0x10
6.94.1.31 #define UART_LCR_PARITY 0x08
6.94.1.32 #define UART_LCR_RESET 0x03
6.94.1.33 #define UART_LCR_SBC 0x40
6.94.1.34 #define UART_LCR_SPAR 0x20
6.94.1.35 #define UART_LCR_STOP 0x04
6.94.1.36 #define UART_LCR_WLEN5 0x00
6.94.1.37 #define UART_LCR_WLEN6 0x01
6.94.1.38 #define UART_LCR_WLEN7 0x02
6.94.1.39 #define UART_LCR_WLEN8 0x03
6.94.1.40 #define UART_LSR 5
6.94.1.41 #define UART_LSR_BREAK 0x10
6.94.1.42 #define UART_LSR_FRAME 0x08
6.94.1.43 #define UART_LSR_OVRRUN 0x02
6.94.1.44 #define UART_LSR_PARITY 0x04
6.94.1.45 #define UART_LSR_RDRDY 0x01
```

**6.94.1.50 #define UART\_MCR 4**

**6.94.1.51 #define UART\_MCR\_AUX1 0x04**

**6.94.1.52 #define UART\_MCR\_AUX2 0x08**

**6.94.1.53 #define UART\_MCR\_DTR 0x01**

**6.94.1.54 #define UART\_MCR\_LOOP 0x10**

**6.94.1.55 #define UART\_MCR\_RTS 0x02**

**6.94.1.56 #define UART\_MSR 6**

**6.94.1.57 #define UART\_MSR\_CTS 0x10**

**6.94.1.58 #define UART\_MSR\_DCD 0x80**

**6.94.1.59 #define UART\_MSR\_DCTS 0x01**

**6.94.1.60 #define UART\_MSR\_DDCD 0x08**

**6.94.1.61 #define UART\_MSR\_DDSR 0x02**

**6.94.1.62 #define UART\_MSR\_DSR 0x20**

**6.94.1.63 #define UART\_MSR\_RI 0x40**

**6.94.1.64 #define UART\_MSR\_TERI 0x04**

**6.94.1.65 #define UART\_RXBUF 0**

**6.94.1.66 #define UART\_SCR 7**

**6.94.1.67 #define UART\_TXBUF 0**

**6.94.1.68 #define UART\_VALID\_FCR 0xc0**

**6.94.1.69 #define UART\_VALID\_IER 0x0f**

**6.94.1.70 #define UART\_VALID\_IIR 0x0f**

**6.94.1.71 #define UART\_VALID\_LCR 0xff**

**6.94.1.72 #define UART\_VALID\_LSR 0xff**

**6.94.1.73 #define UART\_VALID\_MCR 0x1f**

**6.94.1.74 #define UART\_VALID\_MSR 0xff**

**6.94.1.75 #define UART\_VAPI\_BUF\_LEN 128**

Size of VAPI command buffer



## 6.94.2 Function Documentation

6.94.2.1 static unsigned long char\_clks (int dll, int dlh, int lcr) [static]

6.94.2.2 void reg\_uart\_sec (void)

Here is the call graph for this function:

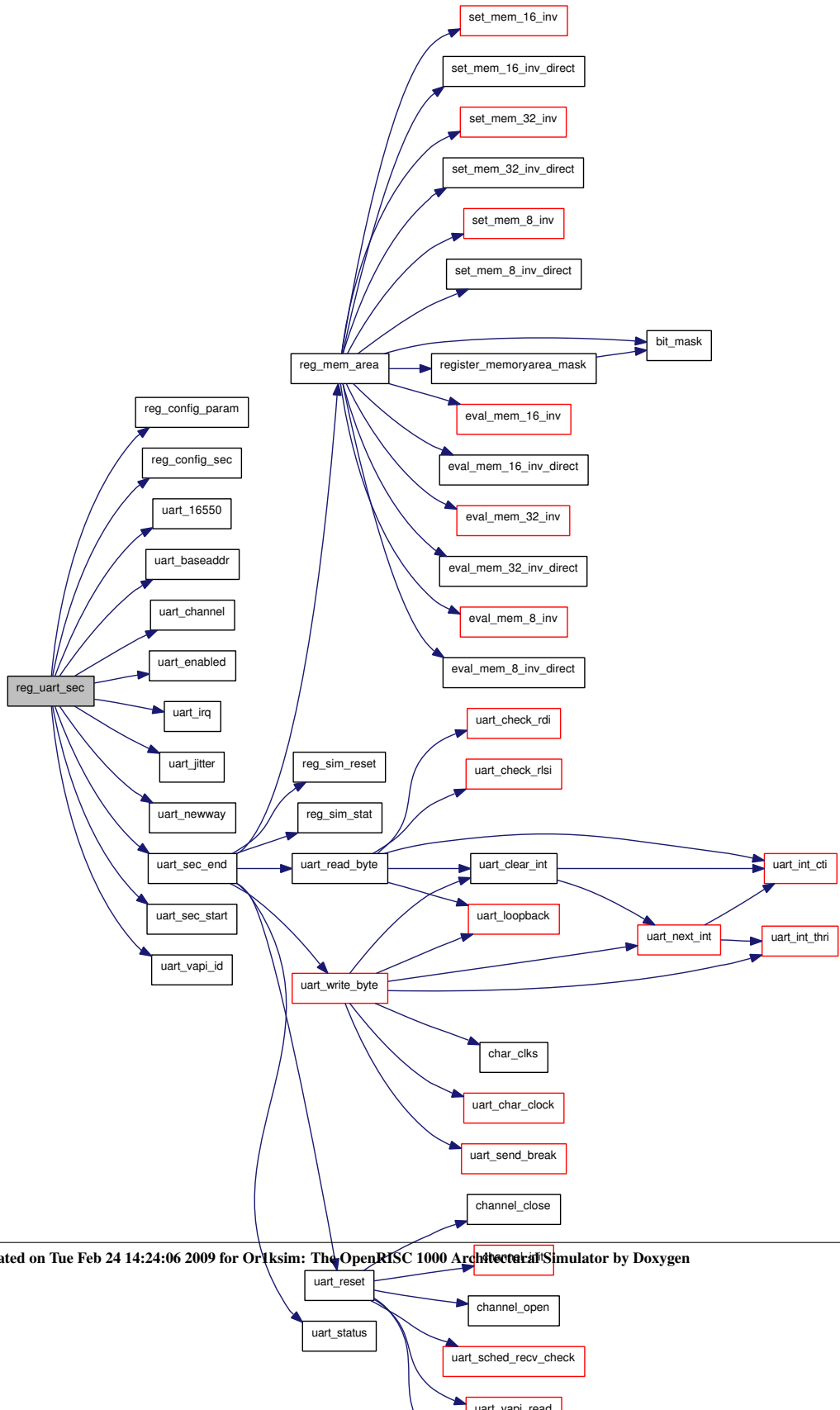





6.94.2.8 void uart\_char\_clock (void \* dat)

Here is the call graph for this function:

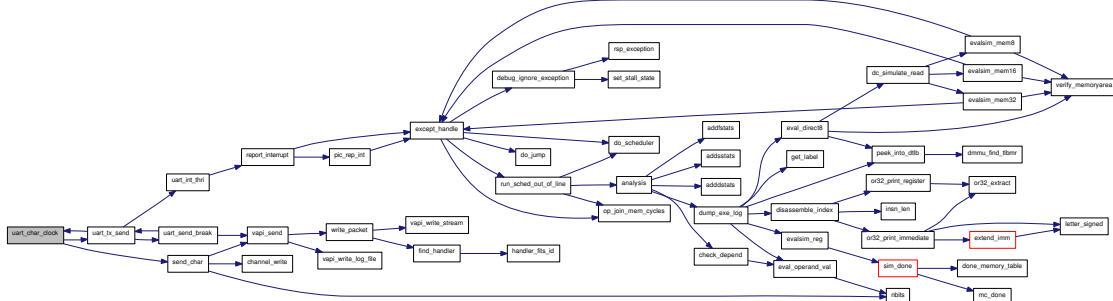

6.94.2.9 static void uart\_check\_char (void \* dat) [static]

Here is the call graph for this function:

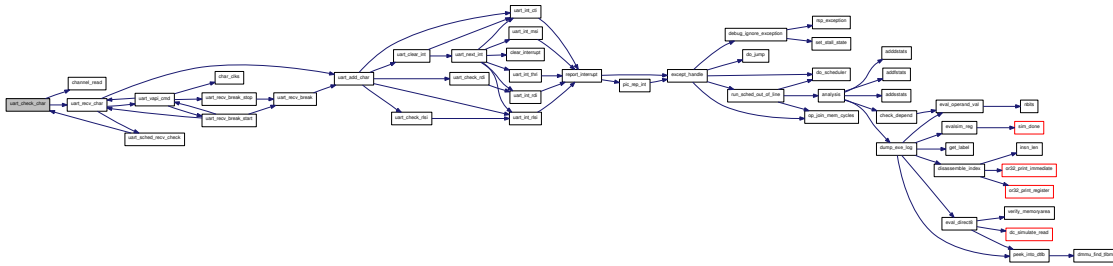

6.94.2.10 static void uart\_check\_rdi (void \* dat) [static]

Here is the call graph for this function:

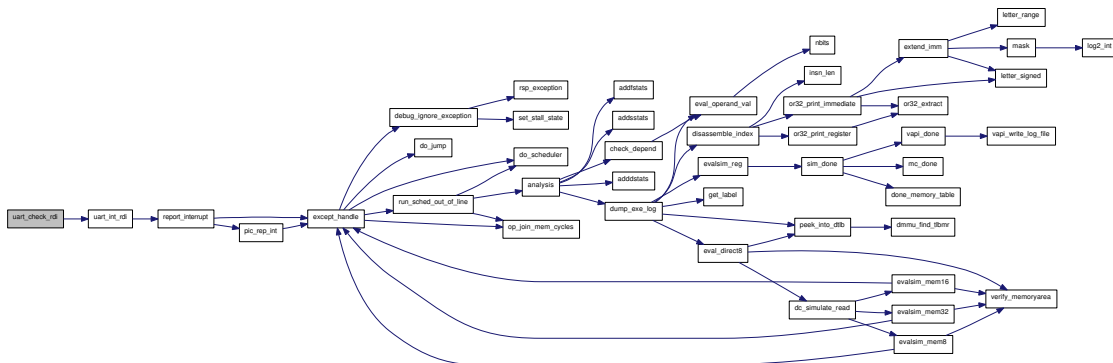

### 6.94.2.11 static void uart\_check\_rlsi (void \* dat) [static]

Here is the call graph for this function:

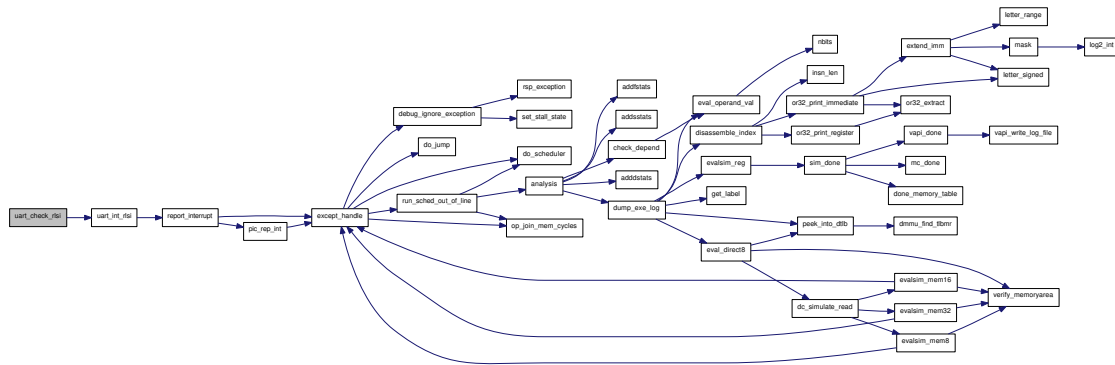

### 6.94.2.12 static void uart\_clear\_int (struct dev\_16450 \* uart, int intr) [static]

Here is the call graph for this function:

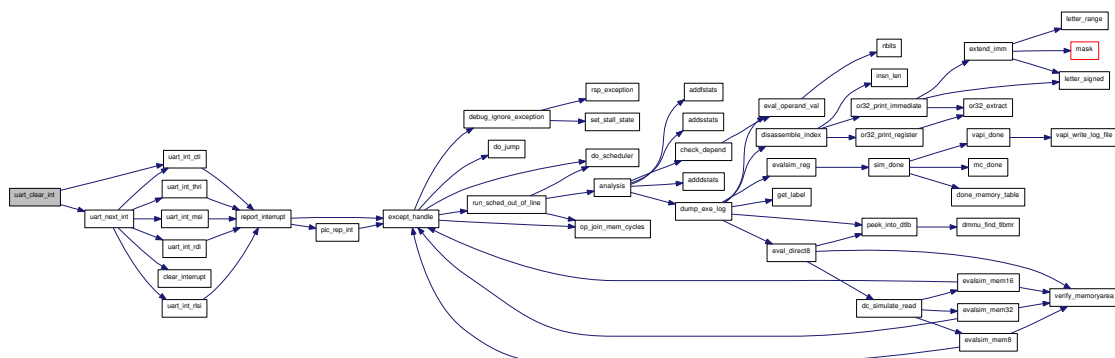

**6.94.2.13** `static void uart_enabled (union param_val val, void * dat)` [static]

**6.94.2.14** `static void uart_int_cti (void * dat)` [static]

Here is the call graph for this function:

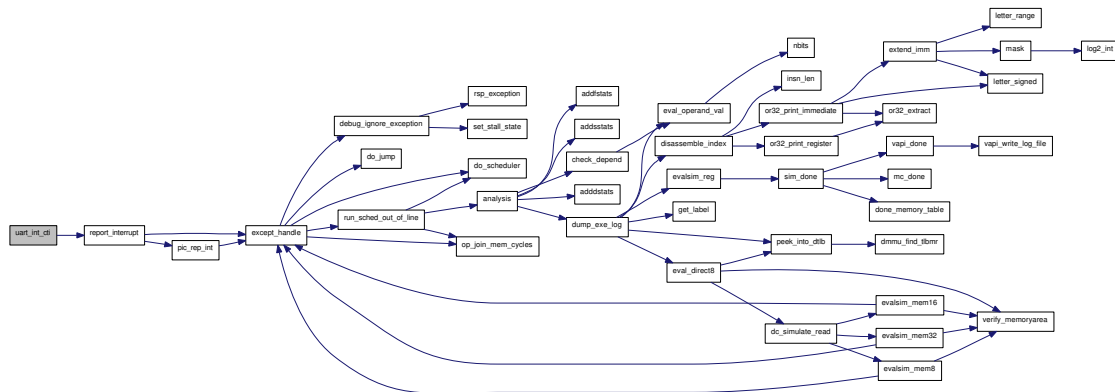

**6.94.2.15** `static void uart_int_msi (void * dat)` [static]

Here is the call graph for this function:

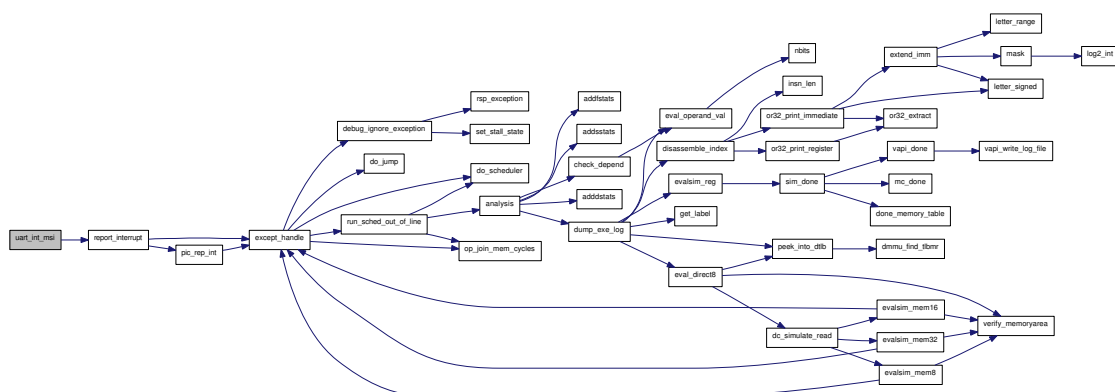

### 6.94.2.16 static void uart\_int\_rdi (void \* dat) [static]

Here is the call graph for this function:

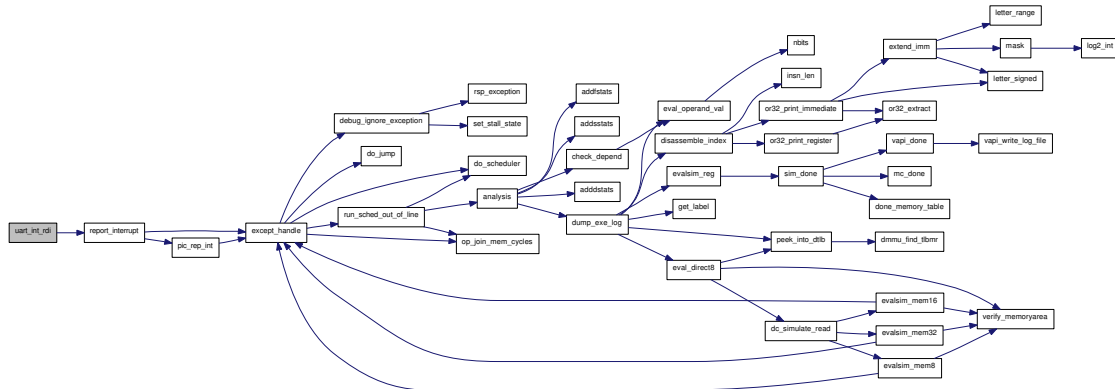

### 6.94.2.17 static void uart\_int\_rlsi (void \* dat) [static]

Here is the call graph for this function:

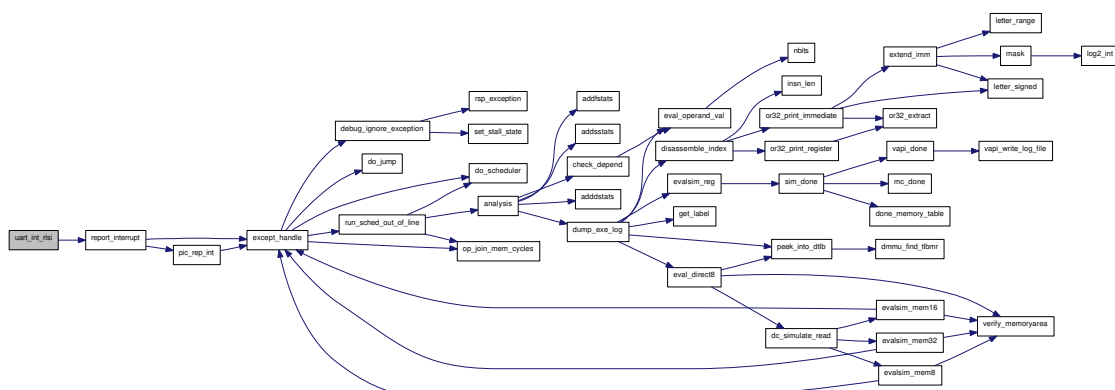

### 6.94.2.18 static void uart\_int\_thri (void \* dat) [static]

Here is the call graph for this function:

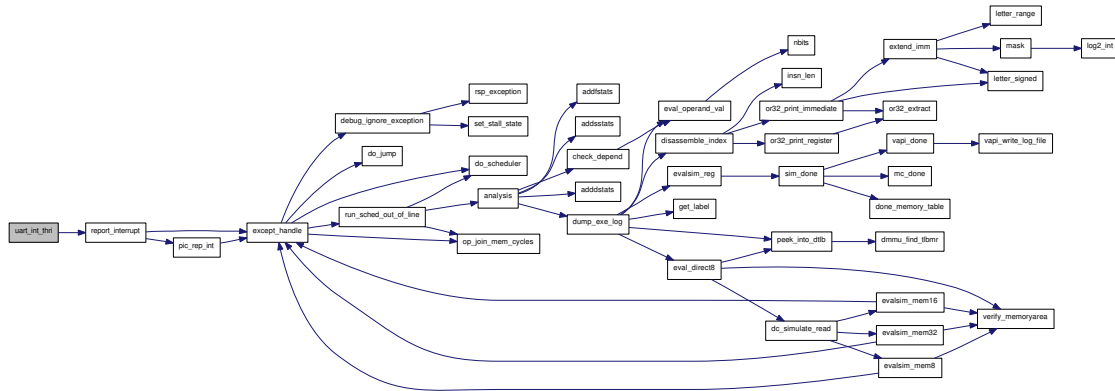

### 6.94.2.19 static void uart\_irq (union param\_val val, void \* dat) [static]

### 6.94.2.20 static void uart\_jitter (union param\_val val, void \* dat) [static]

### 6.94.2.21 static void uart\_loopback (struct dev\_16450 \* uart) [static]

Here is the call graph for this function:

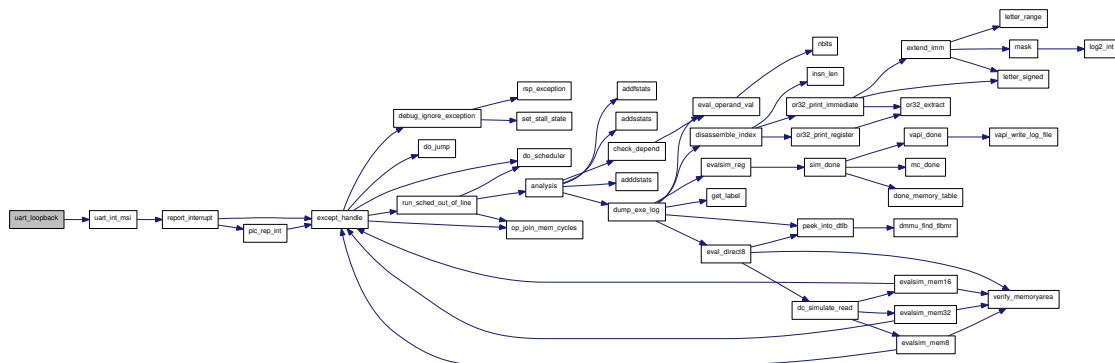



### 6.94.2.26 static void uart\_rcv\_break\_start (void \* dat) [static]

Here is the call graph for this function:

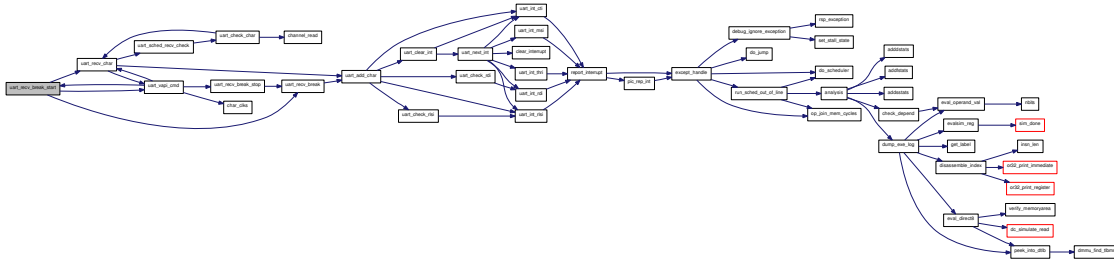

### 6.94.2.27 static void uart\_rcv\_break\_stop (void \* dat) [static]

Here is the call graph for this function:

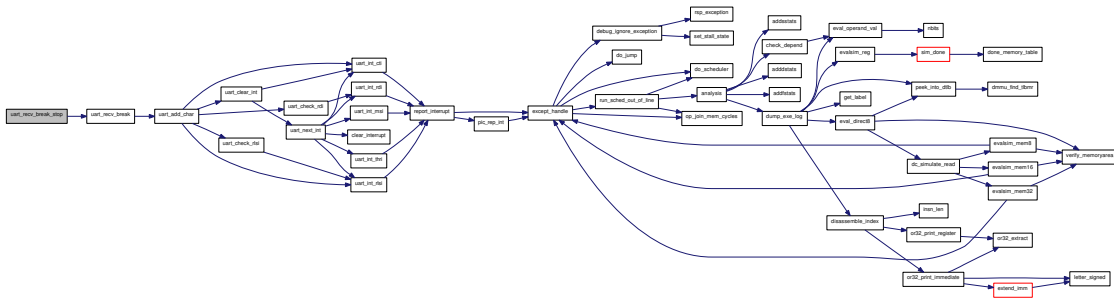

### 6.94.2.28 static void uart\_rcv\_char (void \* dat) [static]

Here is the call graph for this function:

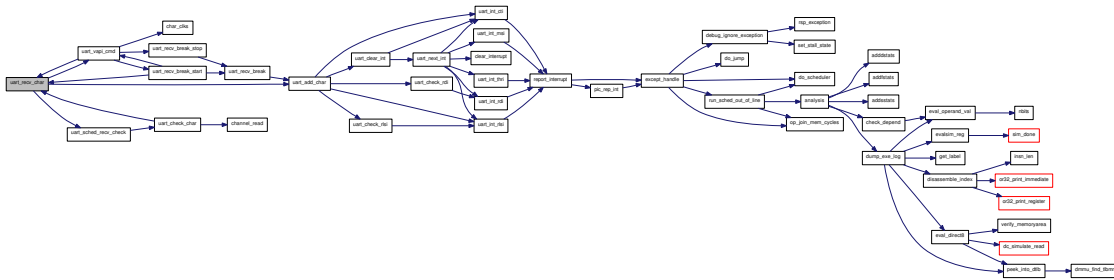

### 6.94.2.29 void uart\_reset (void \* dat)

Here is the call graph for this function:

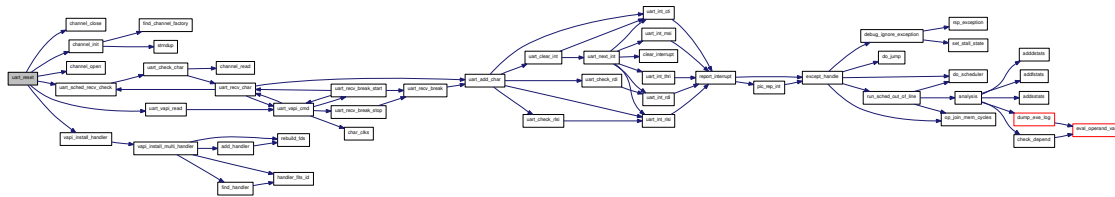

### 6.94.2.30 static void uart\_sched\_recv\_check (struct dev\_16450 \* uart) [static]

Here is the call graph for this function:

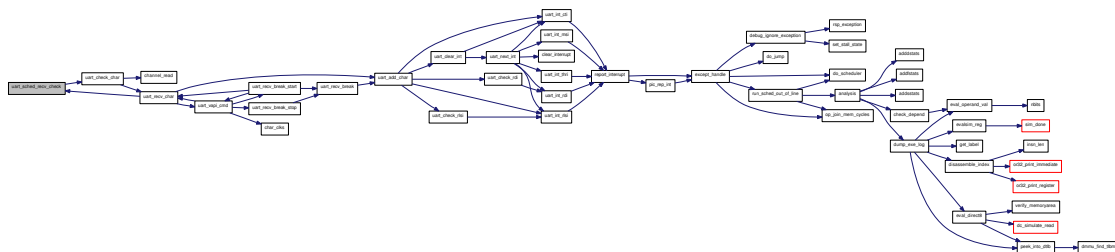



**6.94.2.31 static void uart\_sec\_end (void \* dat) [static]**

Here is the call graph for this function:

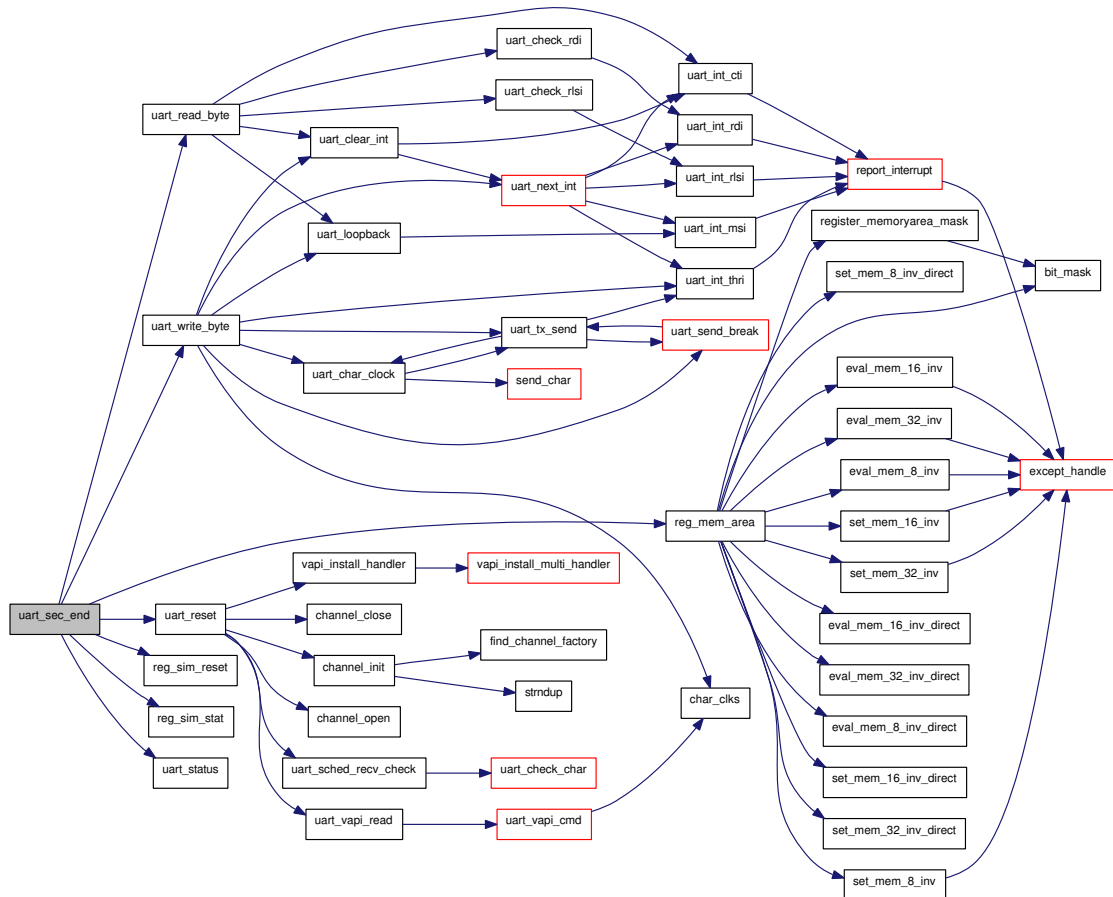
**6.94.2.32 static void\* uart\_sec\_start () [static]**

Initialize a new UART configuration

ALL parameters are set explicitly to default values.

### 6.94.2.33 void uart\_send\_break (void \* dat)

Here is the call graph for this function:

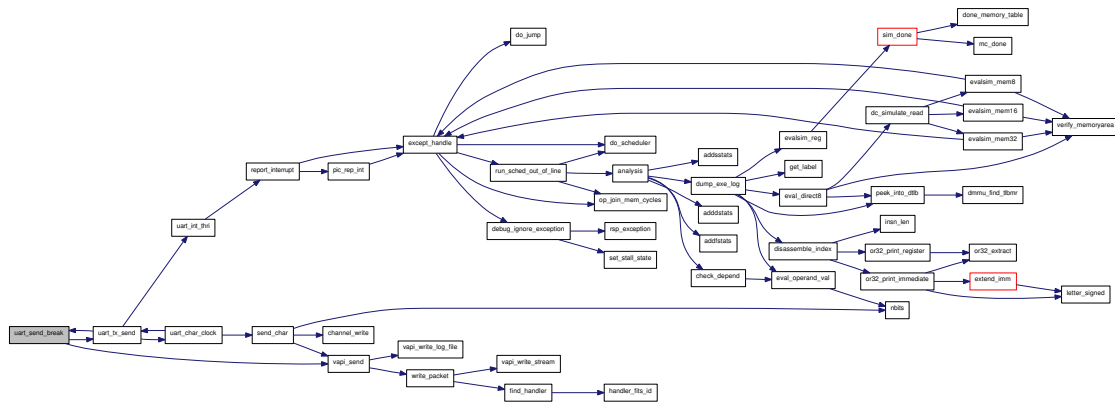

### 6.94.2.34 void uart\_status (void \* dat)

### 6.94.2.35 void uart\_tx\_send (void \* dat) [static]

Here is the call graph for this function:

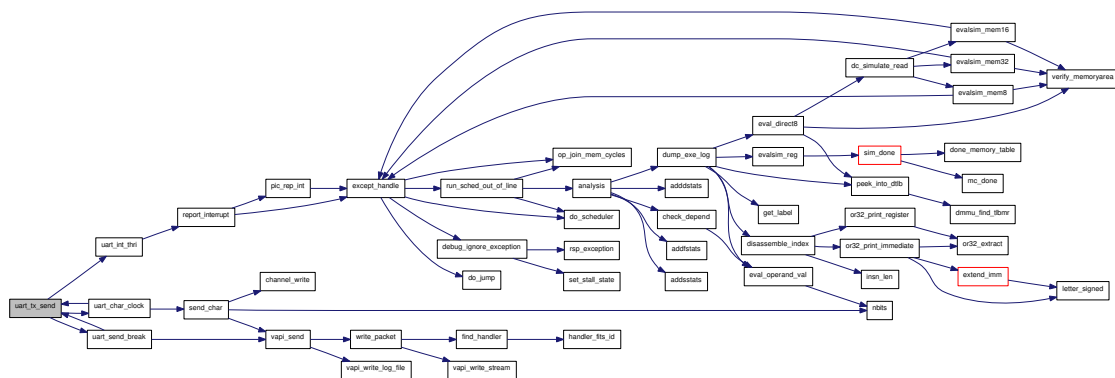

**6.94.2.36** static void uart\_vapi\_cmd (void \* dat) [static]

Here is the call graph for this function:

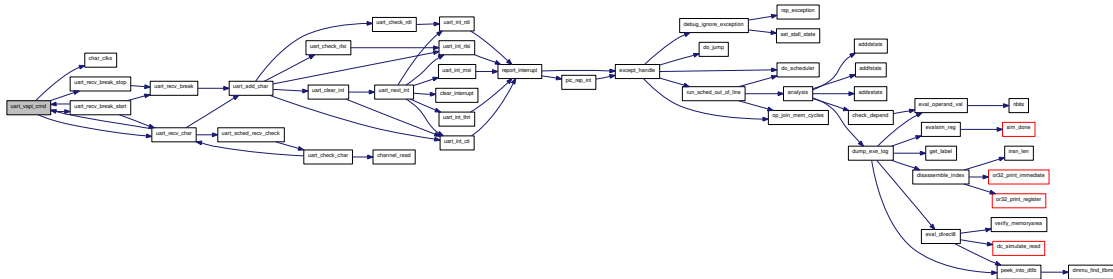

**6.94.2.37** static void uart\_vapi\_id (union param\_val val, void \* dat) [static]

**6.94.2.38** static void uart\_vapi\_read (unsigned long id, unsigned long data, void \* dat) [static]

Here is the call graph for this function:

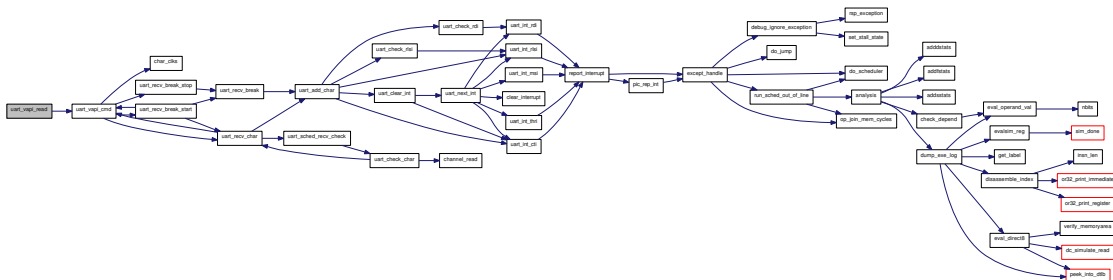

**6.94.2.39** static void uart\_write\_byte (oraddr\_t addr, uint8\_t value, void \* dat) [static]

Here is the call graph for this function:

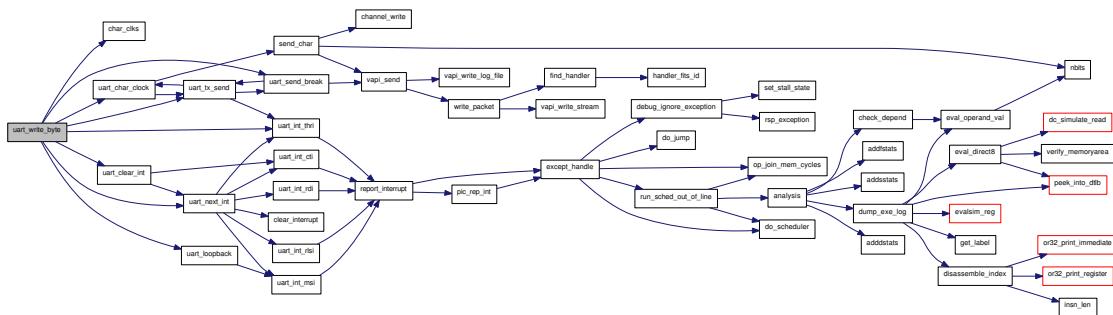

## 6.95 peripheral/16450.h File Reference

This graph shows which files directly or indirectly include this file:

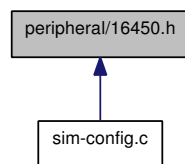

### Functions

- void [uart\\_reset](#) ()
  
- void [uart\\_status](#) ()
  
- void [reg\\_uart\\_sec](#) ()



### 6.95.1 Function Documentation

#### 6.95.1.1 void reg\_uart\_sec ()

Here is the call graph for this function:

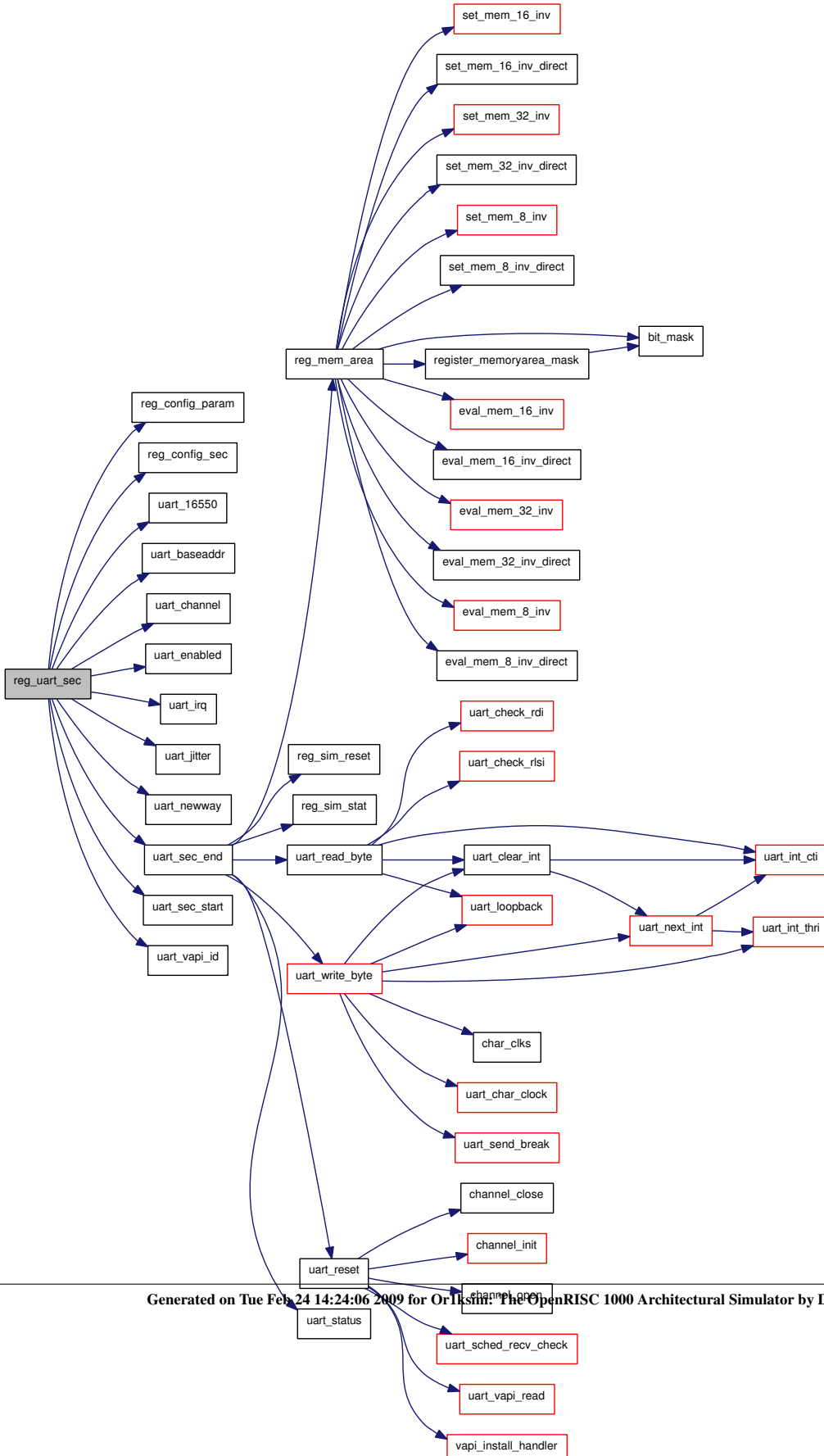

6.95.1.2 void uart\_reset ()

6.95.1.3 void uart\_status ()

## 6.96 peripheral/atacmd.h File Reference

This graph shows which files directly or indirectly include this file:

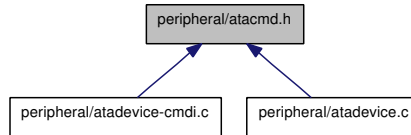

### Defines

- #define [CFA\\_ERASE\\_SECTORS](#) 0xC0
- #define [CFA\\_REQUEST\\_EXTENDED\\_ERROR\\_CODE](#) 0x03
- #define [CFA\\_TRANSLATE\\_SECTOR](#) 0x87
- #define [CFA\\_WRITE\\_MULTIPLE\\_WITHOUT\\_ERASE](#) 0xCD
- #define [CFA\\_WRITE\\_SECTORS\\_WITHOUT\\_ERASE](#) 0x38
- #define [CHECK\\_POWER\\_MODE](#) 0xE5
- #define [DEVICE\\_RESET](#) 0x08
- #define [DOWNLOAD\\_MICROCODE](#) 0x92
- #define [EXECUTE\\_DEVICE\\_DIAGNOSTICS](#) 0x90
- #define [FLUSH\\_CACHE](#) 0xE7
- #define [GET\\_MEDIA\\_STATUS](#) 0xDA
- #define [IDENTIFY\\_DEVICE](#) 0xEC
- #define [IDENTIFY\\_PACKET\\_DEVICE](#) 0xA1
- #define [IDLE](#) 0xE3
- #define [IDLE\\_IMMEDIATE](#) 0xE1
- #define [INITIALIZE\\_DEVICE\\_PARAMETERS](#) 0x91
- #define [MEDIA\\_EJECT](#) 0xED
- #define [MEDIA\\_LOCK](#) 0xDE
- #define [MEDIA\\_UNLOCK](#) 0xDF
- #define [NOP](#) 0x00
- #define [PACKET](#) 0xA0
- #define [READ\\_BUFFER](#) 0xE4
- #define [READ\\_DMA](#) 0xC8
- #define [READ\\_DMA\\_QUEUED](#) 0xC7
- #define [READ\\_MULTIPLE](#) 0xC4
- #define [READ\\_NATIVE\\_MAX\\_ADDRESS](#) 0xF8
- #define [READ\\_SECTOR](#) 0x20
- #define [READ\\_SECTORS](#) 0x20
- #define [READ\\_VERIFY\\_SECTOR](#) 0x40
- #define [READ\\_VERIFY\\_SECTORS](#) 0x40
- #define [SECURITY\\_DISABLE\\_PASSWORD](#) 0xF6
- #define [SECURITY\\_ERASE\\_PREPARE](#) 0xF3
- #define [SECURITY\\_ERASE\\_UNIT](#) 0xF4
- #define [SECURITY\\_FREEZE\\_LOCK](#) 0xF5
- #define [SECURITY\\_SET\\_PASSWORD](#) 0xF1
- #define [SECURITY\\_UNLOCK](#) 0xF2
- #define [SEEK](#) 0x70



- #define SERVICE 0xA2
- #define SET\_FEATURES 0xEF
- #define SET\_MAX 0xF9
- #define SET\_MULTIPLE\_MODE 0xC6
- #define SLEEP 0xE6
- #define SMART 0xB0
- #define STANDBY 0xE2
- #define STANDBY\_IMMEDIATE 0xE0
- #define WRITE\_BUFFER 0xE8
- #define WRITE\_DMA 0xCA
- #define WRITE\_DMA\_QUEUED 0xCC
- #define WRITE\_MULTIPLE 0xC5
- #define WRITE\_SECTOR 0x30
- #define WRITE\_SECTORS 0x30
- #define CFA\_ENABLE\_8BIT\_PIO\_TRANSFER\_MODE 0x01
- #define ENABLE\_WRITE\_CACHE 0x02
- #define SET\_TRANSFER\_MODE\_SECTOR\_COUNT\_REG 0x03
- #define ENABLE\_ADVANCED\_POWER\_MANAGEMENT 0x05
- #define ENABLE\_POWERUP\_IN\_STANDBY\_FEATURE\_SET 0x06
- #define POWERUP\_IN\_STANDBY\_FEATURE\_SET\_SPINUP 0x07
- #define CFA\_ENABLE\_POWER\_MODE1 0x0A
- #define DISABLE\_MEDIA\_STATUS\_NOTIFICATION 0x31
- #define DISABLE\_READ\_LOOKAHEAD 0x55
- #define ENABLE\_RELEASE\_INTERRUPT 0x5D
- #define ENABLE\_SERVICE\_INTERRUPT 0x5E
- #define DISABLE\_REVERTING\_TO\_POWERON\_DEFAULTS 0x66
- #define CFA\_DISABLE\_8BIT\_PIO\_TRANSFER\_MODE 0x81
- #define DISABLE\_WRITE\_CACHE 0x82
- #define DISABLE\_ADVANCED\_POWER\_MANAGEMENT 0x85
- #define DISABLE\_POWERUP\_IN\_STANDBY\_FEATURE\_SET 0x86
- #define CFA\_DISABLE\_POWER\_MODE1 0x8A
- #define ENABLE\_MEDIA\_STATUS\_NOTIFICATION 0x95
- #define ENABLE\_READ\_LOOKAHEAD\_FEATURE 0xAA
- #define ENABLE\_REVERTING\_TO\_POWERON\_DEFAULTS 0xCC
- #define DISABLE\_RELEASE\_INTERRUPT 0xDD
- #define DISABLE\_SERVICE\_INTERRUPT 0xDE
- #define SET\_MAX\_ADDRESS 0x00
- #define SET\_MAX\_SET\_PASSWORD 0x01
- #define SET\_MAX\_LOCK 0x02
- #define SET\_MAX\_UNLOCK 0x03
- #define SET\_MAX\_FREEZE\_LOCK 0x04
- #define SMART\_READ\_DATA 0xD0
- #define SMART\_ATTRIBITE\_AUTOSAVE 0xD1
- #define SMART\_SAVE\_ATTRIBUTE\_VALUES 0xD3
- #define SMART\_EXECUTE\_OFFLINE\_IMMEDIATE 0xD4
- #define SMART\_READ\_LOG 0xD5
- #define SMART\_WRITE\_LOG 0xD6
- #define SMART\_ENABLE\_OPERATIONS 0xD8
- #define SMART\_DISABLE\_OPERATIONS 0xD9
- #define SMART\_RETURN\_STATUS 0xDA



## 6.96.1 Define Documentation

- 6.96.1.1 `#define CFA_DISABLE_8BIT_PIO_TRANSFER_MODE 0x81`
- 6.96.1.2 `#define CFA_DISABLE_POWER_MODE1 0x8A`
- 6.96.1.3 `#define CFA_ENABLE_8BIT_PIO_TRANSFER_MODE 0x01`
- 6.96.1.4 `#define CFA_ENABLE_POWER_MODE1 0x0A`
- 6.96.1.5 `#define CFA_ERASE_SECTORS 0xC0`
- 6.96.1.6 `#define CFA_REQUEST_EXTENDED_ERROR_CODE 0x03`
- 6.96.1.7 `#define CFA_TRANSLATE_SECTOR 0x87`
- 6.96.1.8 `#define CFA_WRITE_MULTIPLE_WITHOUT_ERASE 0xCD`
- 6.96.1.9 `#define CFA_WRITE_SECTORS_WITHOUT_ERASE 0x38`
- 6.96.1.10 `#define CHECK_POWER_MODE 0xE5`
- 6.96.1.11 `#define DEVICE_RESET 0x08`
- 6.96.1.12 `#define DISABLE_ADVANCED_POWER_MANAGEMENT 0x85`
- 6.96.1.13 `#define DISABLE_MEDIA_STATUS_NOTIFICATION 0x31`
- 6.96.1.14 `#define DISABLE_POWERUP_IN_STANDBY_FEATURE_SET 0x86`
- 6.96.1.15 `#define DISABLE_READ_LOOKAHEAD 0x55`
- 6.96.1.16 `#define DISABLE_RELEASE_INTERRUPT 0xDD`
- 6.96.1.17 `#define DISABLE_REVERTING_TO_POWERON_DEFAULTS 0x66`
- 6.96.1.18 `#define DISABLE_SERVICE_INTERRUPT 0xDE`
- 6.96.1.19 `#define DISABLE_WRITE_CACHE 0x82`
- 6.96.1.20 `#define DOWNLOAD_MICROCODE 0x92`
- 6.96.1.21 `#define ENABLE_ADVANCED_POWER_MANAGEMENT 0x05`
- 6.96.1.22 `#define ENABLE_MEDIA_STATUS_NOTIFICATION 0x95`
- 6.96.1.23 `#define ENABLE_POWERUP_IN_STANDBY_FEATURE_SET 0x06`
- 6.96.1.24 `#define ENABLE_READ_LOOKAHEAD_FEATURE 0xAA`
- 6.96.1.25 `#define ENABLE_RELEASE_INTERRUPT 0x5D`
- 6.96.1.26 `#define ENABLE_REVERTING_TO_POWERON_DEFAULTS 0xCC`
- 6.96.1.27 `#define ENABLE_SERVICE_INTERRUPT 0x5E`
- 6.96.1.28 `#define ENABLE_WRITE_CACHE 0x02`
- 6.96.1.29 `#define EXECUTE_DEVICE_DIAGNOSTICS 0x90`
- 6.96.1.30 `#define FLUSH_CACHE 0xE7`

## 6.97 peripheral/atadevice-cmdi.c File Reference

```
#include "config.h"
#include "atadevice-cmdi.h"
#include "atahost.h"
#include "atacmd.h"
#include "sched.h"
```

Include dependency graph for atadevice-cmdi.c:

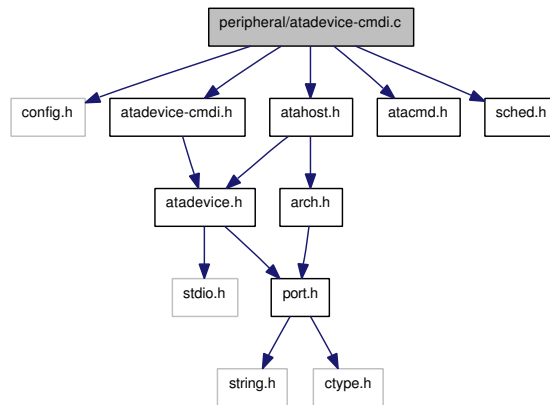

## Functions

- static void [ata\\_cmd\\_complete](#) (void \*dat)
- static void [ata\\_set\\_sect](#) (struct [ata\\_device](#) \*dev, uint32\_t sect)
- static uint32\_t [ata\\_calc\\_lba](#) (struct [ata\\_device](#) \*dev)
- static void [ata\\_read\\_sect](#) (struct [ata\\_device](#) \*dev)
- static void [ata\\_write\\_sect](#) (struct [ata\\_device](#) \*dev)
- static void [ata\\_set\\_device\\_signature](#) (struct [ata\\_device](#) \*device, int packet)
- void [ata\\_execute\\_device\\_diagnostics\\_cmd](#) (struct [ata\\_device](#) \*device)
- static void [ata\\_device\\_reset\\_cmd](#) (struct [ata\\_device](#) \*device)
- static void [ata\\_identify\\_device\\_cmd](#) (struct [ata\\_device](#) \*device)
- static void [ata\\_initialize\\_device\\_parameters\\_cmd](#) (struct [ata\\_device](#) \*device)
- static void [ata\\_read\\_sectors\\_cmd](#) (struct [ata\\_device](#) \*device)
- static void [ata\\_read\\_native\\_max\\_addr](#) (struct [ata\\_device](#) \*dev)
- static void [ata\\_write\\_sectors](#) (struct [ata\\_device](#) \*dev)
- static void [ata\\_set\\_features](#) (struct [ata\\_device](#) \*dev)
- int [ata\\_device\\_execute\\_cmd](#) (struct [ata\\_device](#) \*device)

## 6.97.1 Function Documentation

**6.97.1.1** `static uint32_t ata_calc_lba (struct ata_device * dev)` [static]

**6.97.1.2** `static void ata_cmd_complete (void * dat)` [static]

Here is the call graph for this function:

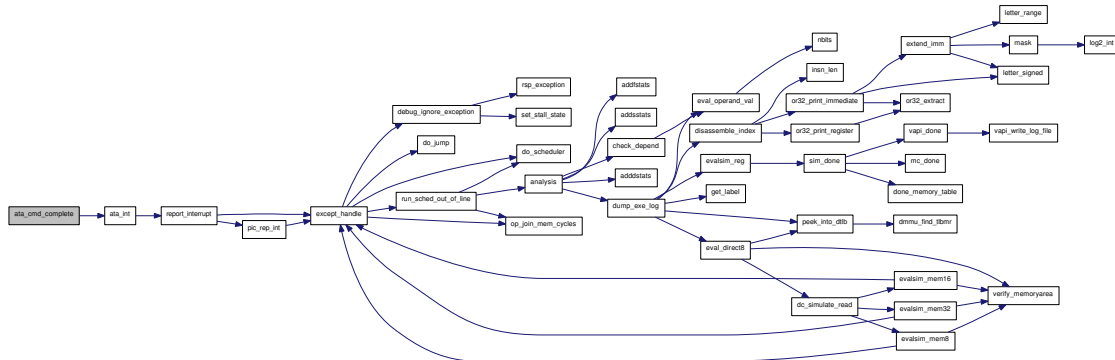

**6.97.1.3** `int ata_device_execute_cmd (struct ata_device * device)`

Here is the call graph for this function:

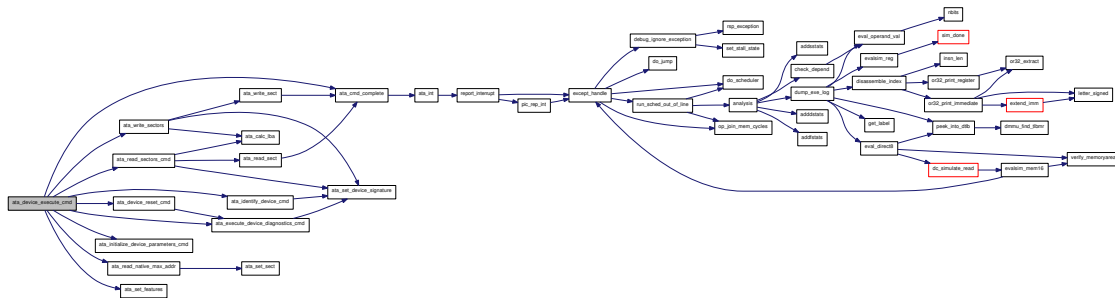

**6.97.1.4** `static void ata_device_reset_cmd (struct ata_device * device)` [static]

Here is the call graph for this function:

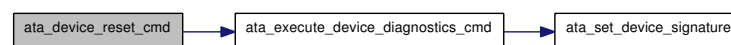

### 6.97.1.5 void ata\_execute\_device\_diagnostics\_cmd (struct ata\_device \* device)

Here is the call graph for this function:

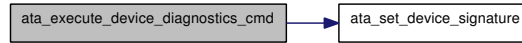

### 6.97.1.6 static void ata\_identify\_device\_cmd (struct ata\_device \* device) [static]

Here is the call graph for this function:



### 6.97.1.7 static void ata\_initialize\_device\_parameters\_cmd (struct ata\_device \* device) [static]

### 6.97.1.8 static void ata\_read\_native\_max\_addr (struct ata\_device \* dev) [static]

Here is the call graph for this function:

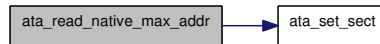

### 6.97.1.9 static void ata\_read\_sect (struct ata\_device \* dev) [static]

Here is the call graph for this function:

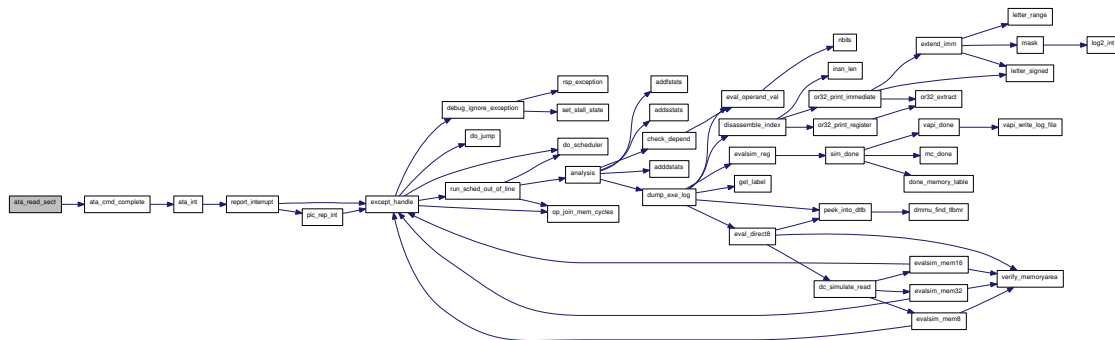

6.97.1.10 static void ata\_read\_sectors\_cmd (struct ata\_device \* device) [static]

Here is the call graph for this function:

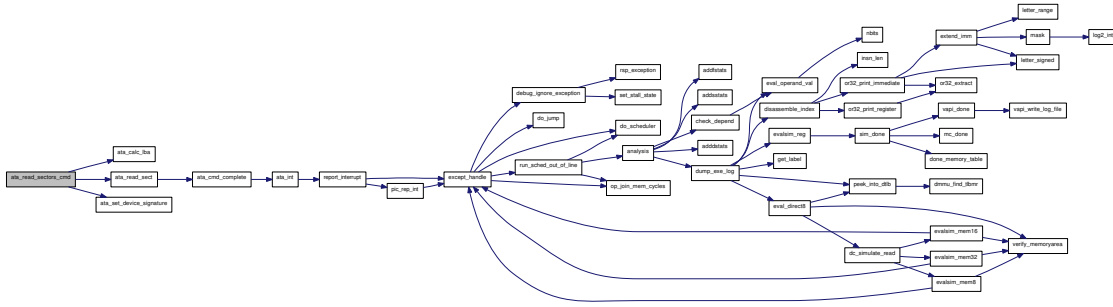

6.97.1.11 static void ata\_set\_device\_signature (struct ata\_device \* device, int packet) [static]

6.97.1.12 static void ata\_set\_features (struct ata\_device \* dev) [static]

6.97.1.13 static void ata\_set\_sect (struct ata\_device \* dev, uint32\_t sect) [static]

6.97.1.14 static void ata\_write\_sect (struct ata\_device \* dev) [static]

Here is the call graph for this function:

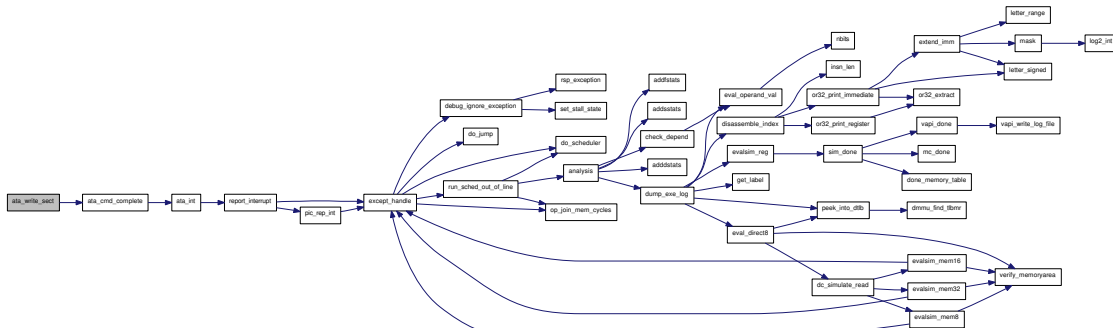





## 6.98 peripheral/atadevice-cmdi.h File Reference

```
#include "atadevice.h"
```

Include dependency graph for atadevice-cmdi.h:

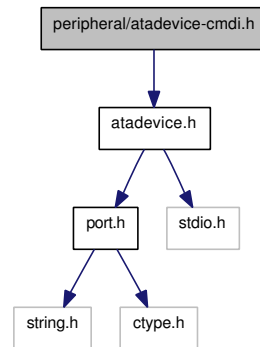

This graph shows which files directly or indirectly include this file:

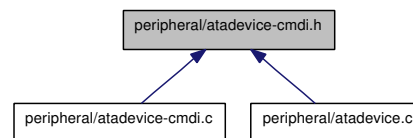

### Defines

- #define [BYTES\\_PER\\_SECTOR](#) 512
- #define [MIN\\_MWDMA\\_CYCLE\\_TIME](#) 100
- #define [RECOMMENDED\\_MWDMA\\_CYCLE\\_TIME](#) 100
- #define [MIN\\_PIO\\_CYCLE\\_TIME\\_NO\\_IORDY](#) 100
- #define [MIN\\_PIO\\_CYCLE\\_TIME\\_IORDY](#) 100
- #define [SUPPORT\\_NOP\\_CMD](#) 0
- #define [SUPPORT\\_READ\\_BUFFER\\_CMD](#) 0
- #define [SUPPORT\\_WRITE\\_BUFFER\\_CMD](#) 0
- #define [SUPPORT\\_HOST\\_PROTECTED\\_AREA](#) 0
- #define [SUPPORT\\_DEVICE\\_RESET\\_CMD](#) 1
- #define [SUPPORT\\_SERVICE\\_INTERRUPT](#) 0
- #define [SUPPORT\\_RELEASE\\_INTERRUPT](#) 0
- #define [SUPPORT\\_LOOKAHEAD](#) 0
- #define [SUPPORT\\_WRITE\\_CACHE](#) 0
- #define [SUPPORT\\_POWER\\_MANAGEMENT](#) 0
- #define [SUPPORT\\_REMOVABLE\\_MEDIA](#) 0
- #define [SUPPORT\\_SECURITY\\_MODE](#) 0
- #define [SUPPORT\\_SMART](#) 0
- #define [SUPPORT\\_SET\\_MAX](#) 0
- #define [SET\\_FEATURES\\_REQUIRED\\_AFTER\\_POWER\\_UP](#) 0
- #define [SUPPORT\\_POWER\\_UP\\_IN\\_STANDBY\\_MODE](#) 0

- #define [SUPPORT\\_REMOVABLE\\_MEDIA\\_NOTIFICATION](#) 0
  
- #define [SUPPORT\\_APM](#) 0
  
- #define [SUPPORT\\_CFA](#) 0
  
- #define [SUPPORT\\_READ\\_WRITE\\_DMA\\_QUEUED](#) 0
  
- #define [SUPPORT\\_DOWNLOAD\\_MICROCODE](#) 0
  
- #define [QUEUE\\_DEPTH](#) 0

## Functions

- int [ata\\_device\\_execute\\_cmd](#) (struct [ata\\_device](#) \*device)
  
- void [ata\\_execute\\_device\\_diagnostics\\_cmd](#) (struct [ata\\_device](#) \*device)



## 6.98.1 Define Documentation

- 6.98.1.1 `#define BYTES_PER_SECTOR 512`
- 6.98.1.2 `#define MIN_MWDMA_CYCLE_TIME 100`
- 6.98.1.3 `#define MIN_PIO_CYCLE_TIME_IORDY 100`
- 6.98.1.4 `#define MIN_PIO_CYCLE_TIME_NO_IORDY 100`
- 6.98.1.5 `#define QUEUE_DEPTH 0`
- 6.98.1.6 `#define RECOMMENDED_MWDMA_CYCLE_TIME 100`
- 6.98.1.7 `#define SET_FEATURES_REQUIRED_AFTER_POWER_UP 0`
- 6.98.1.8 `#define SUPPORT_APM 0`
- 6.98.1.9 `#define SUPPORT_CFA 0`
- 6.98.1.10 `#define SUPPORT_DEVICE_RESET_CMD 1`
- 6.98.1.11 `#define SUPPORT_DOWNLOAD_MICROCODE 0`
- 6.98.1.12 `#define SUPPORT_HOST_PROTECTED_AREA 0`
- 6.98.1.13 `#define SUPPORT_LOOKAHEAD 0`
- 6.98.1.14 `#define SUPPORT_NOP_CMD 0`
- 6.98.1.15 `#define SUPPORT_POWER_MANAGEMENT 0`
- 6.98.1.16 `#define SUPPORT_POWER_UP_IN_STANDBY_MODE 0`
- 6.98.1.17 `#define SUPPORT_READ_BUFFER_CMD 0`
- 6.98.1.18 `#define SUPPORT_READ_WRITE_DMA_QUEUED 0`
- 6.98.1.19 `#define SUPPORT_RELEASE_INTERRUPT 0`
- 6.98.1.20 `#define SUPPORT_REMOVABLE_MEDIA 0`
- 6.98.1.21 `#define SUPPORT_REMOVABLE_MEDIA_NOTIFICATION 0`
- 6.98.1.22 `#define SUPPORT_SECURITY_MODE 0`
- 6.98.1.23 `#define SUPPORT_SERVICE_INTERRUPT 0`
- 6.98.1.24 `#define SUPPORT_SET_MAX 0`
- 6.98.1.25 `#define SUPPORT_SMART 0`
- 6.98.1.26 `#define SUPPORT_WRITE_BUFFER_CMD 0`
- 6.98.1.27 `#define SUPPORT_WRITE_CACHE 0`

## 6.98.2 Function Documentation

- 6.98.2.1 `int ata_device_execute_cmd (struct ata_device * device)`

Here is the call graph for this function:

**6.98.2.2 void ata\_execute\_device\_diagnostics\_cmd (struct ata\_device \* device)**

Here is the call graph for this function:

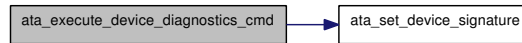

## 6.99 peripheral/atadevice.c File Reference

```
#include "config.h"
#include "port.h"
#include <byteswap.h>
#include "atadevice.h"
#include "atadevice-cmdi.h"
#include "atacmd.h"
#include "abstract.h"
```

Include dependency graph for atadevice.c:

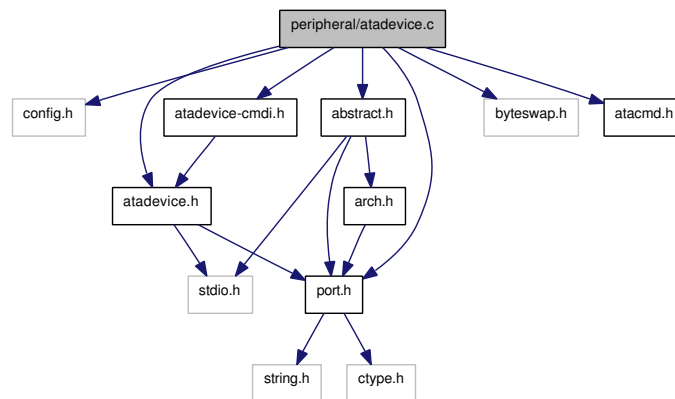

## Functions

- static FILE \* [open\\_file](#) (uint32\_t \*size, const char \*filename)
- static FILE \* [open\\_local](#) (void)
- static void [ata\\_device\\_init](#) (struct [ata\\_device](#) \*device, int dev)
- void [ata\\_devices\\_init](#) (struct [ata\\_devices](#) \*devices)
- static void [ata\\_device\\_hw\\_reset](#) (struct [ata\\_device](#) \*device, int reset\_signal, int daspo, int pdiagi, int daspi)
- void [ata\\_devices\\_hw\\_reset](#) (struct [ata\\_devices](#) \*devices, int reset\_signal)
- static void [ata\\_device\\_do\\_control\\_register](#) (struct [ata\\_device](#) \*device)
- static void [ata\\_device\\_do\\_command\\_register](#) (struct [ata\\_device](#) \*device)
- short [ata\\_devices\\_read](#) (struct [ata\\_devices](#) \*devices, char adr)
- static void [ata\\_device\\_write](#) (struct [ata\\_device](#) \*device, char adr, short value)
- void [ata\\_devices\\_write](#) (struct [ata\\_devices](#) \*devices, char adr, short value)

### 6.99.1 Function Documentation

#### 6.99.1.1 static void ata\_device\_do\_command\_register (struct ata\_device \* device) [static]

Here is the call graph for this function:

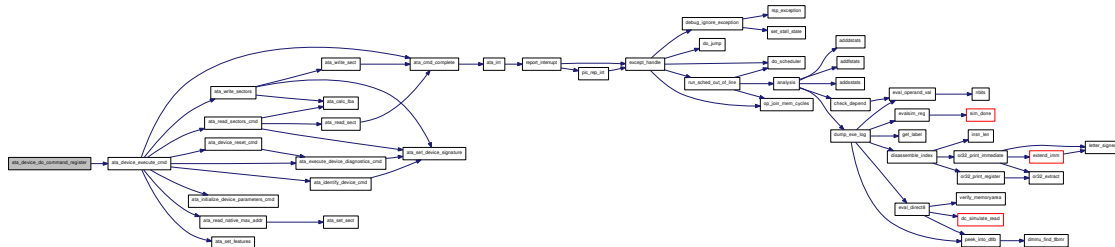

#### 6.99.1.2 static void ata\_device\_do\_control\_register (struct ata\_device \* device) [static]

Here is the call graph for this function:

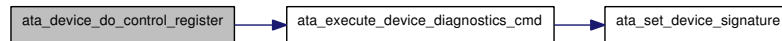

#### 6.99.1.3 static void ata\_device\_hw\_reset (struct ata\_device \* device, int reset\_signal, int daspo, int pdiagi, int daspi) [static]

Here is the call graph for this function:

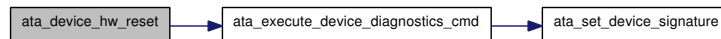

#### 6.99.1.4 static void ata\_device\_init (struct ata\_device \* device, int dev) [static]

Here is the call graph for this function:

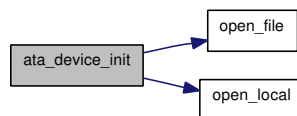





**6.99.1.10** static FILE\* `open_file` (uint32\_t \* *size*, const char \* *filename*) [static]

**6.99.1.11** static FILE\* `open_local` (void) [static]

## 6.100 peripheral/atadevice.h File Reference

```
#include "port.h"
#include <stdio.h>
```

Include dependency graph for atadevice.h:

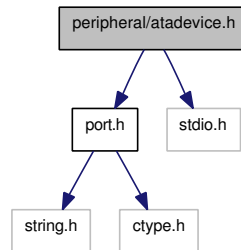

This graph shows which files directly or indirectly include this file:

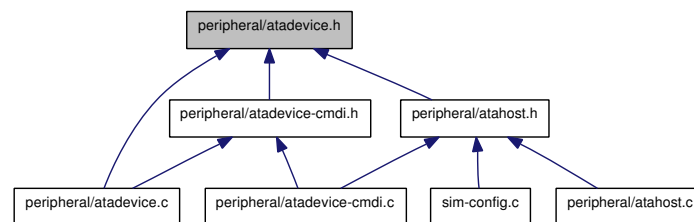

### Data Structures

- struct [ata\\_device](#)
- struct [ata\\_devices](#)

### Defines

- #define [ATA\\_ASR](#) 0x78
- #define [ATA\\_CR](#) 0x5c
- #define [ATA\\_CHR](#) 0x54
- #define [ATA\\_CLR](#) 0x50
- #define [ATA\\_DR](#) 0x40
- #define [ATA\\_DCR](#) 0x78
- #define [ATA\\_DHR](#) 0x58
- #define [ATA\\_ERR](#) 0x44
- #define [ATA\\_FR](#) 0x44
- #define [ATA\\_SCR](#) 0x48
- #define [ATA\\_SNR](#) 0x4c
- #define [ATA\\_SR](#) 0x5c
- #define [ATA\\_DA](#) 0x7c
- #define [ATA\\_SR\\_BSY](#) 0x80
- #define [ATA\\_SR\\_DRDY](#) 0x40

- #define [ATA\\_SR\\_DF](#) 0x20
- #define [ATA\\_SR\\_DSC](#) 0x10
- #define [ATA\\_SR\\_DRQ](#) 0x08
- #define [ATA\\_SR\\_COR](#) 0x04
- #define [ATA\\_SR\\_IDX](#) 0x02
- #define [ATA\\_SR\\_ERR](#) 0x01
- #define [ATA\\_DCR\\_RST](#) 0x04
- #define [ATA\\_DCR\\_IEN](#) 0x02
- #define [ATA\\_DAR\\_WTG](#) 0x40
- #define [ATA\\_DAR\\_H](#) 0x3c
- #define [ATA\\_DAR\\_DS1](#) 0x02
- #define [ATA\\_DAR\\_DS0](#) 0x01
- #define [ATA\\_DHR\\_LBA](#) 0x40
- #define [ATA\\_DHR\\_DEV](#) 0x10
- #define [ATA\\_DHR\\_H](#) 0x0f
- #define [ATA\\_ERR\\_BBK](#) 0x80
- #define [ATA\\_ERR\\_UNC](#) 0x40
- #define [ATA\\_ERR\\_IDNF](#) 0x10
- #define [ATA\\_ERR\\_ABT](#) 0x04
- #define [ATA\\_ERR\\_TON](#) 0x02
- #define [ATA\\_ERR\\_AMN](#) 0x01
- #define [TYPE\\_NO\\_CONNECT](#) 0
- #define [TYPE\\_FILE](#) 1
- #define [TYPE\\_LOCAL](#) 2
- #define [ATA\\_STATE\\_IDLE](#) 0x00
- #define [ATA\\_STATE\\_SW\\_RST](#) 0x01
- #define [ATA\\_STATE\\_HW\\_RST](#) 0x02

## Functions

- void [ata\\_devices\\_init](#) (struct [ata\\_devices](#) \*devices)
- void [ata\\_devices\\_hw\\_reset](#) (struct [ata\\_devices](#) \*devices, int reset\_signal)
- short [ata\\_devices\\_read](#) (struct [ata\\_devices](#) \*devices, char adr)
- void [ata\\_devices\\_write](#) (struct [ata\\_devices](#) \*devices, char adr, short value)



## 6.100.1 Define Documentation

- 6.100.1.1 `#define ATA_ASR 0x78`
- 6.100.1.2 `#define ATA_CHR 0x54`
- 6.100.1.3 `#define ATA_CLR 0x50`
- 6.100.1.4 `#define ATA_CR 0x5c`
- 6.100.1.5 `#define ATA_DA 0x7c`
- 6.100.1.6 `#define ATA_DAR_DS0 0x01`
- 6.100.1.7 `#define ATA_DAR_DS1 0x02`
- 6.100.1.8 `#define ATA_DAR_H 0x3c`
- 6.100.1.9 `#define ATA_DAR_WTG 0x40`
- 6.100.1.10 `#define ATA_DCR 0x78`
- 6.100.1.11 `#define ATA_DCR_IEN 0x02`
- 6.100.1.12 `#define ATA_DCR_RST 0x04`
- 6.100.1.13 `#define ATA_DHR 0x58`
- 6.100.1.14 `#define ATA_DHR_DEV 0x10`
- 6.100.1.15 `#define ATA_DHR_H 0x0f`
- 6.100.1.16 `#define ATA_DHR_LBA 0x40`
- 6.100.1.17 `#define ATA_DR 0x40`
- 6.100.1.18 `#define ATA_ERR 0x44`
- 6.100.1.19 `#define ATA_ERR_ABT 0x04`
- 6.100.1.20 `#define ATA_ERR_AMN 0x01`
- 6.100.1.21 `#define ATA_ERR_BBK 0x80`
- 6.100.1.22 `#define ATA_ERR_IDNF 0x10`
- 6.100.1.23 `#define ATA_ERR_TON 0x02`
- 6.100.1.24 `#define ATA_ERR_UNC 0x40`
- 6.100.1.25 `#define ATA_FR 0x44`
- 6.100.1.26 `#define ATA_SCR 0x48`
- 6.100.1.27 `#define ATA_SNR 0x4c`

---

Generated on Tue Feb 27 19:24:00 2009 for OoRism: The OpenRISC 1000 Architectural Simulator by Doxygen

- 6.100.1.28 `#define ATA_SR 0x5c`

- 6.100.1.29 `#define ATA_SR_BSY 0x80`

- 6.100.1.30 `#define ATA_SR_COR 0x04`

### 6.100.2.2 void ata\_devices\_init (struct ata\_devices \* devices)

Here is the call graph for this function:

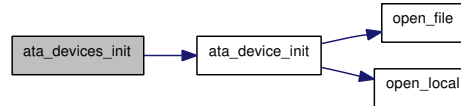

### 6.100.2.3 short ata\_devices\_read (struct ata\_devices \* devices, char adr)

### 6.100.2.4 void ata\_devices\_write (struct ata\_devices \* devices, char adr, short value)

Here is the call graph for this function:

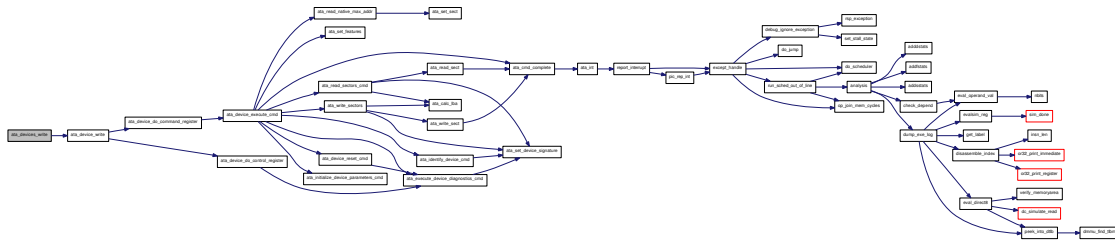

## 6.101 peripheral/atahost.c File Reference

```
#include "config.h"
#include "port.h"
#include <stdlib.h>
#include "atahost.h"
#include "sim-config.h"
#include "abstract.h"
#include "pic.h"
#include "toplevel-support.h"
#include "sim-cmd.h"
```

Include dependency graph for atahost.c:

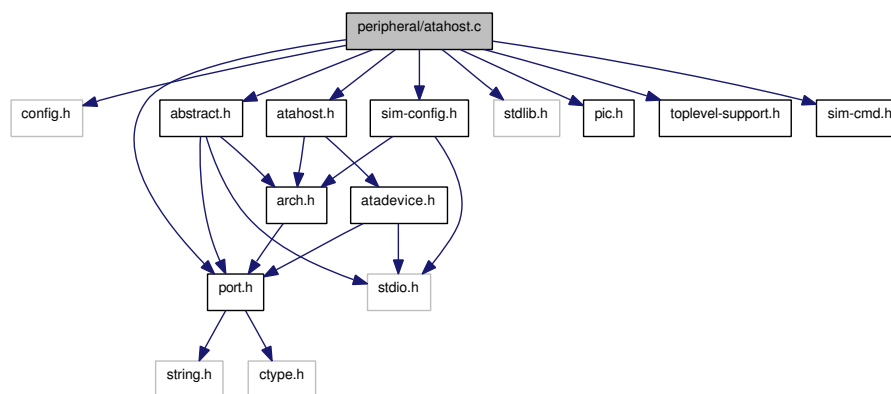

### Defines

- #define [PIO\\_MODE0\\_T1](#) 6
- #define [PIO\\_MODE0\\_T2](#) 28
- #define [PIO\\_MODE0\\_T4](#) 2
- #define [PIO\\_MODE0\\_TEOC](#) 23
- #define [DMA\\_MODE0\\_TM](#) 4
- #define [DMA\\_MODE0\\_TD](#) 21
- #define [DMA\\_MODE0\\_TEOC](#) 21

### Functions

- static void [ata\\_reset](#) (void \*dat)
- void [ata\\_int](#) (void \*dat)
- static uint32\_t [ata\\_read32](#) (oraddr\_t addr, void \*dat)
- static void [ata\\_write32](#) (oraddr\_t addr, uint32\_t value, void \*dat)
- static void [ata\\_status](#) (void \*dat)
- static void [ata\\_baseaddr](#) (union [param\\_val](#) val, void \*dat)
- static void [ata\\_irq](#) (union [param\\_val](#) val, void \*dat)

- static void [ata\\_dev\\_id](#) (union [param\\_val](#) val, void \*dat)
- static void [ata\\_rev](#) (union [param\\_val](#) val, void \*dat)
- static void [ata\\_pio\\_mode0\\_t1](#) (union [param\\_val](#) val, void \*dat)
- static void [ata\\_pio\\_mode0\\_t2](#) (union [param\\_val](#) val, void \*dat)
- static void [ata\\_pio\\_mode0\\_t4](#) (union [param\\_val](#) val, void \*dat)
- static void [ata\\_pio\\_mode0\\_tec](#) (union [param\\_val](#) val, void \*dat)
- static void [ata\\_dma\\_mode0\\_tm](#) (union [param\\_val](#) val, void \*dat)
- static void [ata\\_dma\\_mode0\\_td](#) (union [param\\_val](#) val, void \*dat)
- static void [ata\\_dma\\_mode0\\_tec](#) (union [param\\_val](#) val, void \*dat)
- static void [ata\\_type](#) (union [param\\_val](#) val, void \*dat)
- static void [ata\\_file](#) (union [param\\_val](#) val, void \*dat)
- static void [ata\\_size](#) (union [param\\_val](#) val, void \*dat)
- static void [ata\\_packet](#) (union [param\\_val](#) val, void \*dat)
- static void [ata\\_enabled](#) (union [param\\_val](#) val, void \*dat)
- static void [ata\\_heads](#) (union [param\\_val](#) val, void \*dat)
- static void [ata\\_sectors](#) (union [param\\_val](#) val, void \*dat)
- static void [ata\\_firmware](#) (union [param\\_val](#) val, void \*dat)
- static void [ata\\_mwdma](#) (union [param\\_val](#) val, void \*dat)
- static void [ata\\_pio](#) (union [param\\_val](#) val, void \*dat)
- static void [ata\\_start\\_device](#) (union [param\\_val](#) val, void \*dat)
- static void [ata\\_enddevice](#) (union [param\\_val](#) val, void \*dat)
- static void \* [ata\\_sec\\_start](#) (void)
- static void [ata\\_sec\\_end](#) (void \*dat)
- void [reg\\_ata\\_sec](#) ()

## Variables

- static unsigned int [conf\\_dev](#)



### 6.101.1 Define Documentation

6.101.1.1 `#define DMA_MODE0_TD 21`

6.101.1.2 `#define DMA_MODE0_TEOC 21`

6.101.1.3 `#define DMA_MODE0_TM 4`

6.101.1.4 `#define PIO_MODE0_T1 6`

6.101.1.5 `#define PIO_MODE0_T2 28`

6.101.1.6 `#define PIO_MODE0_T4 2`

6.101.1.7 `#define PIO_MODE0_TEOC 23`

### 6.101.2 Function Documentation

6.101.2.1 `static void ata_baseaddr (union param_val val, void * dat) [static]`

6.101.2.2 `static void ata_dev_id (union param_val val, void * dat) [static]`

6.101.2.3 `static void ata_dma_mode0_td (union param_val val, void * dat) [static]`

6.101.2.4 `static void ata_dma_mode0_teoc (union param_val val, void * dat) [static]`

6.101.2.5 `static void ata_dma_mode0_tm (union param_val val, void * dat) [static]`

6.101.2.6 `static void ata_enabled (union param_val val, void * dat) [static]`

6.101.2.7 `static void ata_enddevice (union param_val val, void * dat) [static]`

6.101.2.8 `static void ata_file (union param_val val, void * dat) [static]`

Set the ATA file

Free any previously allocated value. Only used if device type is 1.

#### Parameters:

← *val* The value to use

← *dat* The `config` data structure

**6.101.2.9** `static void ata_firmware (union param_val val, void * dat) [static]`

**6.101.2.10** `static void ata_heads (union param_val val, void * dat) [static]`

**6.101.2.11** `void ata_int (void * dat)`

Here is the call graph for this function:

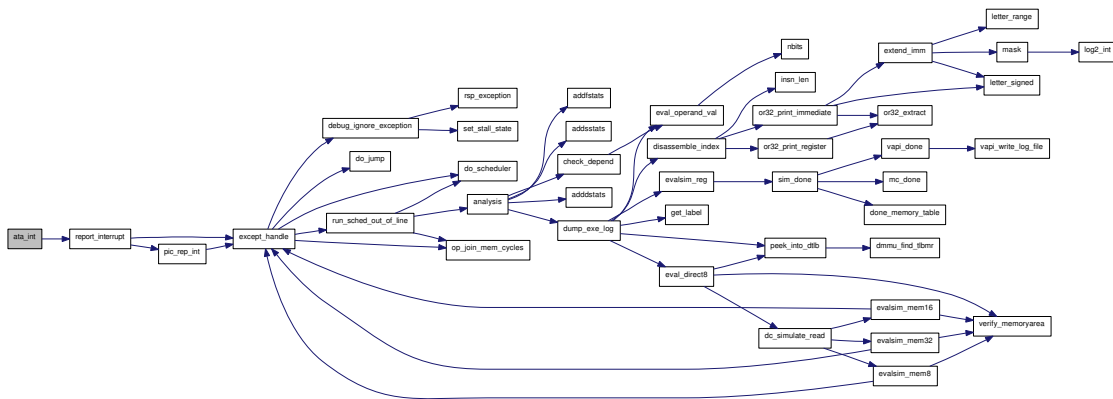

**6.101.2.12** `static void ata_irq (union param_val val, void * dat) [static]`

**6.101.2.13** `static void ata_mwdma (union param_val val, void * dat) [static]`

Set the ATA multi-word DMA mode

Must be -1, 0, 1 or 2.

**Parameters:**

← *val* The value to use

← *dat* The `config` data structure

**6.101.2.14** `static void ata_packet (union param_val val, void * dat) [static]`

**6.101.2.15** `static void ata_pio (union param_val val, void * dat) [static]`

Set the ATA programmed I/O mode

Must be 0, 1, 2, 3 or 4.

**Parameters:**

← *val* The value to use

← *dat* The `config` data structure

**6.101.2.16** `static void ata_pio_mode0_t1 (union param_val val, void * dat)` [static]

**6.101.2.17** `static void ata_pio_mode0_t2 (union param_val val, void * dat)` [static]

**6.101.2.18** `static void ata_pio_mode0_t4 (union param_val val, void * dat)` [static]

**6.101.2.19** `static void ata_pio_mode0_teoc (union param_val val, void * dat)` [static]

**6.101.2.20** `static uint32_t ata_read32 (oraddr_t addr, void * dat)` [static]

Here is the call graph for this function:

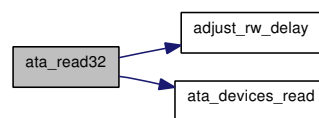

**6.101.2.21** `static void ata_reset (void * dat)` [static]

Here is the call graph for this function:



**6.101.2.22** `static void ata_rev (union param_val val, void * dat)` [static]

Set the ATA revision

This must be in the range 0-15, to fit in the relevant field. Anything larger is truncated with a warning.

#### Parameters:

← *val* The value to use

← *dat* The `config` data structure

### 6.101.2.23 static void ata\_sec\_end (void \* dat) [static]

Here is the call graph for this function:

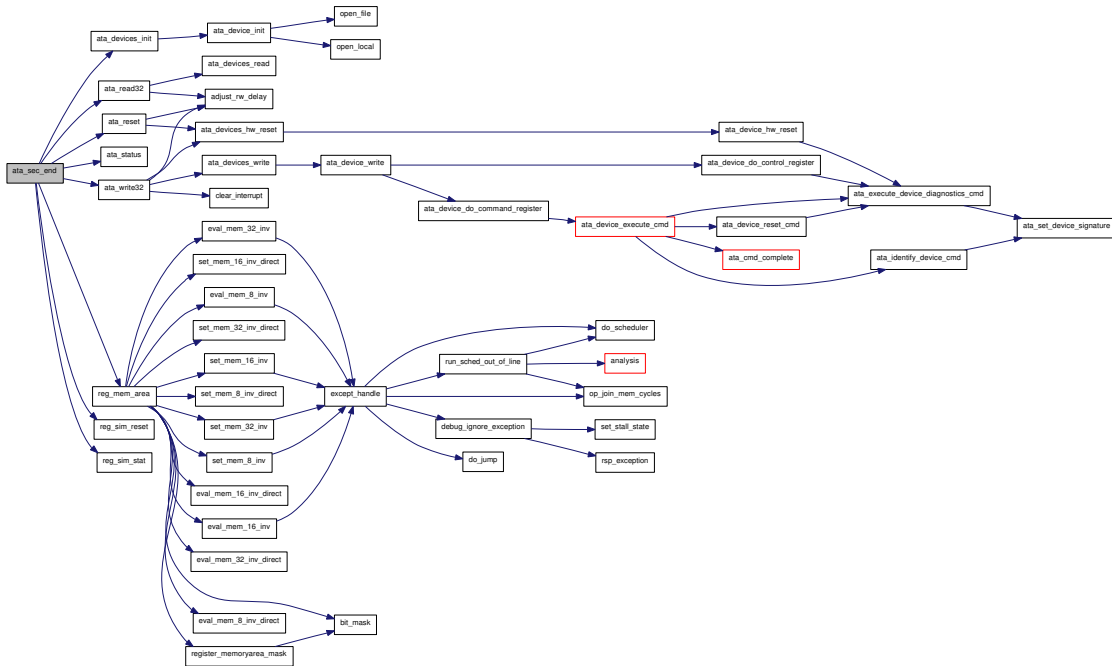

### 6.101.2.24 static void\* ata\_sec\_start (void) [static]

Initialize a new ATA configuration

ALL parameters are set explicitly to default values.

**6.101.2.25** `static void ata_sectors (union param_val val, void * dat)` [static]

**6.101.2.26** `static void ata_size (union param_val val, void * dat)` [static]

**6.101.2.27** `static void ata_start_device (union param_val val, void * dat)` [static]

**6.101.2.28** `static void ata_status (void * dat)` [static]

**6.101.2.29** `static void ata_type (union param_val val, void * dat)` [static]

**6.101.2.30** `static void ata_write32 (oraddr_t addr, uint32_t value, void * dat)` [static]

Here is the call graph for this function:

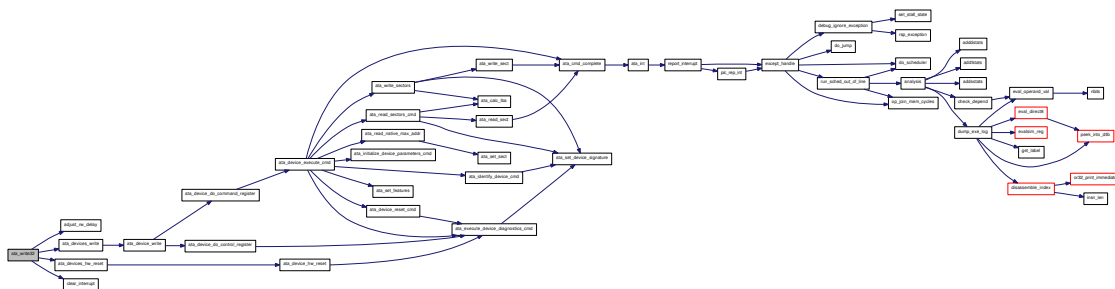



6.101.2.31 void reg\_ata\_sec ()

Here is the call graph for this function:

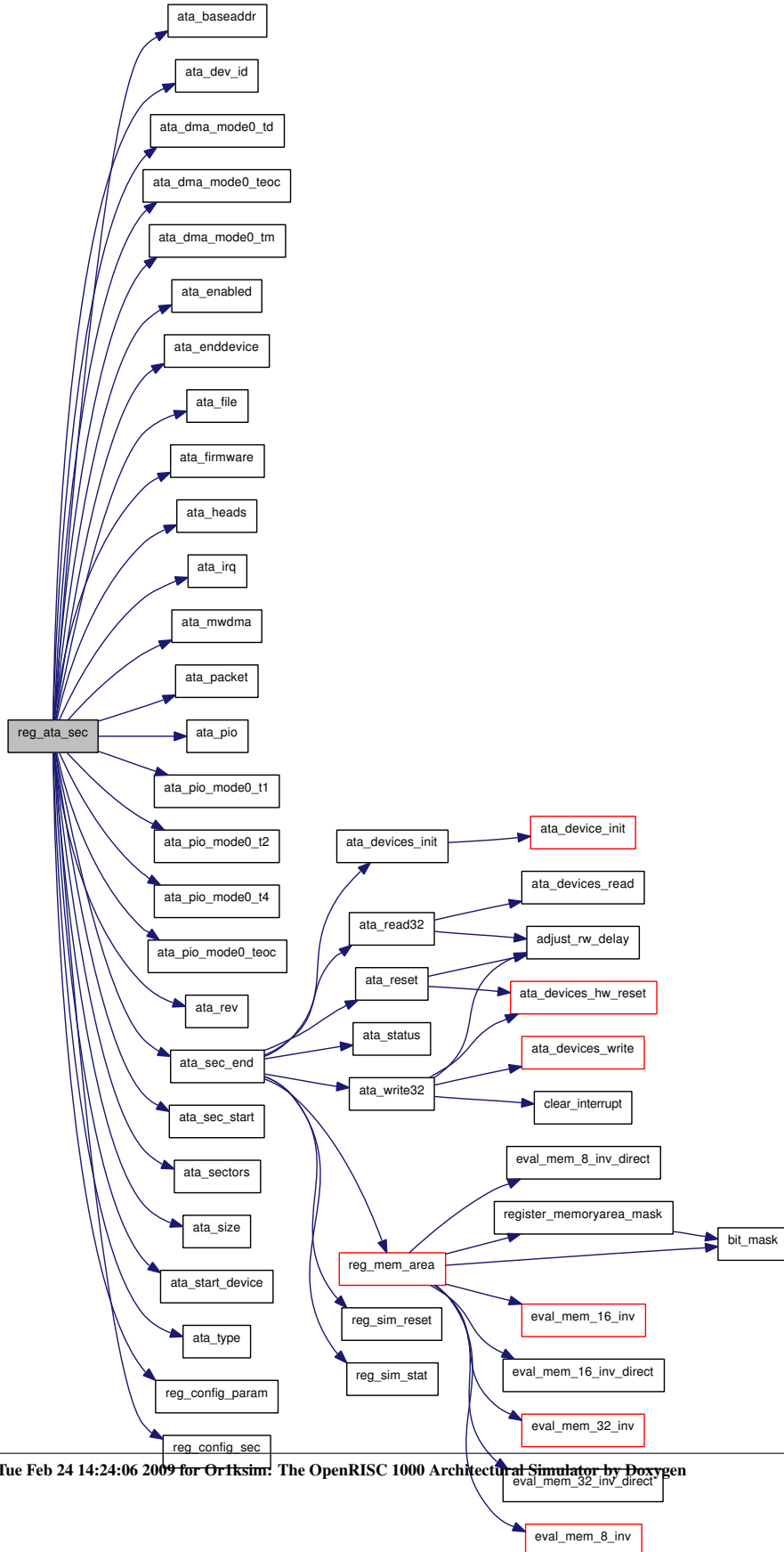

### 6.101.3 Variable Documentation

6.101.3.1 `unsigned int conf_dev` `[static]`



## 6.102 peripheral/atahost.h File Reference

```
#include "arch.h"
#include "atadevice.h"
```

Include dependency graph for atahost.h:

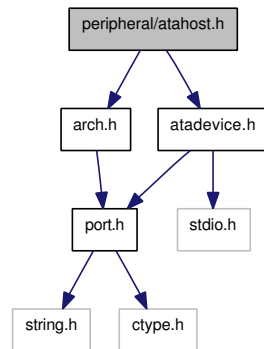

This graph shows which files directly or indirectly include this file:

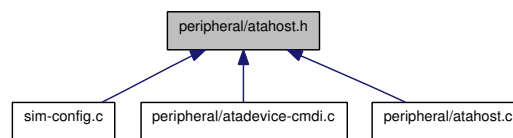

### Data Structures

- struct [ata\\_host](#)

### Defines

- #define [ATA\\_CTRL](#) 0x00
- #define [ATA\\_STAT](#) 0x04
- #define [ATA\\_PCTR](#) 0x08
- #define [ATA\\_PFTR0](#) 0x0c
- #define [ATA\\_PFTR1](#) 0x10
- #define [ATA\\_DTR0](#) 0x14
- #define [ATA\\_DTR1](#) 0x18
- #define [ATA\\_TXB](#) 0x3c
- #define [ATA\\_RXB](#) 0x3c
- #define [ATA\\_DMA\\_EN](#) (0<<15)
- #define [ATA\\_DMA\\_WR](#) (1<<14)
- #define [ATA\\_DMA\\_RD](#) (0<<14)
- #define [ATA\\_BELEC1](#) (1<<9)
- #define [ATA\\_BELECO](#) (1<<8)
- #define [ATA\\_IDE\\_EN](#) (1<<7)
- #define [ATA\\_FTE1](#) (1<<6)

- #define `ATA_FTE0` (1<< 5)
- #define `ATA_PWPP` (1<< 4)
- #define `ATA_IORDY_FTE1` (1<< 3)
- #define `ATA_IORDY_FTE0` (1<< 2)
- #define `ATA_IORDY` (1<< 1)
- #define `ATA_RST` (1<< 0)
- #define `ATA_DEVID` 0xf0000000
- #define `ATA_REVNO` 0x0f000000
- #define `ATA_DMA_TIP` (1<<15)
- #define `ATA_DRBE` (1<<10)
- #define `ATA_DTBF` (1<< 9)
- #define `ATA_DMARQ` (1<< 8)
- #define `ATA_PIO_TIP` (1<< 7)
- #define `ATA_PWPPF` (1<< 6)
- #define `ATA_IDEIS` (1<< 0)
- #define `ATA_TEOC` 24
- #define `ATA_T4` 16
- #define `ATA_T2` 8
- #define `ATA_TD` 8
- #define `ATA_T1` 0
- #define `ATA_TM` 0
- #define `ATA_ADDR_SPACE` 0x80
- #define `is_ata_hostadr`(adr) (!(adr & 0x40))
- #define `ata_pio_delay`(pioreg) ( (((pioreg >> ATA\_T1) & 0xff) +1) + (((pioreg >> ATA\_T2) & 0xff) +1) + (((pioreg >> ATA\_T4) & 0xff) +1) +1 )
- #define `ata_dma_delay`(dmareg) ( (((dmareg >> ATA\_TD) & 0xff) +1) + (((pioreg >> ATA\_TM) & 0xff) +1) +1 )

## Functions

- void `ata_int` (void \*dat)
- void `reg_ata_sec` ()



## 6.102.1 Define Documentation

6.102.1.1 **#define ATA\_ADDR\_SPACE 0x80**

6.102.1.2 **#define ATA\_BELEC0 (1<< 8)**

6.102.1.3 **#define ATA\_BELEC1 (1<< 9)**

6.102.1.4 **#define ATA\_CTRL 0x00**

6.102.1.5 **#define ATA\_DEVID 0xf0000000**

6.102.1.6 **#define ata\_dma\_delay(dmareg) ( (((dmareg >> ATA\_TD) & 0xff) +1) + (((pioreg >> ATA\_TM) & 0xff) +1) +1 )**

6.102.1.7 **#define ATA\_DMA\_EN (0<<15)**

6.102.1.8 **#define ATA\_DMA\_RD (0<<14)**

6.102.1.9 **#define ATA\_DMA\_TIP (1<<15)**

6.102.1.10 **#define ATA\_DMA\_WR (1<<14)**

6.102.1.11 **#define ATA\_DMARQ (1<< 8)**

6.102.1.12 **#define ATA\_DRBE (1<<10)**

6.102.1.13 **#define ATA\_DTBF (1<< 9)**

6.102.1.14 **#define ATA\_DTR0 0x14**

6.102.1.15 **#define ATA\_DTR1 0x18**

6.102.1.16 **#define ATA\_FTE0 (1<< 5)**

6.102.1.17 **#define ATA\_FTE1 (1<< 6)**

6.102.1.18 **#define ATA\_IDE\_EN (1<< 7)**

6.102.1.19 **#define ATA\_IDEIS (1<< 0)**

6.102.1.20 **#define ATA\_IORDY (1<< 1)**

6.102.1.21 **#define ATA\_IORDY\_FTE0 (1<< 2)**

6.102.1.22 **#define ATA\_IORDY\_FTE1 (1<< 3)**

6.102.1.23 **#define ATA\_PCTR 0x08**

6.102.1.24 **#define ATA\_PFTR0 0x0c**

6.102.1.25 **#define ATA\_PFTR1 0x10**

6.102.1.26 **#define ata\_pio\_delay(pioreg) ( (((pioreg >> ATA\_T1) & 0xff) +1) + (((pioreg >> ATA\_T2) & 0xff) +1) + (((pioreg >> ATA\_T3) & 0xff) +1) +1 )**

6.102.1.27 **#define ATA\_PIO\_TIP (1<< 7)**

6.102.1.28 **#define ATA\_PWPP (1<< 4)**

6.102.1.29 **#define ATA\_PWPPF (1<< 6)**



### 6.102.2.2 void reg\_ata\_sec ()

Here is the call graph for this function:

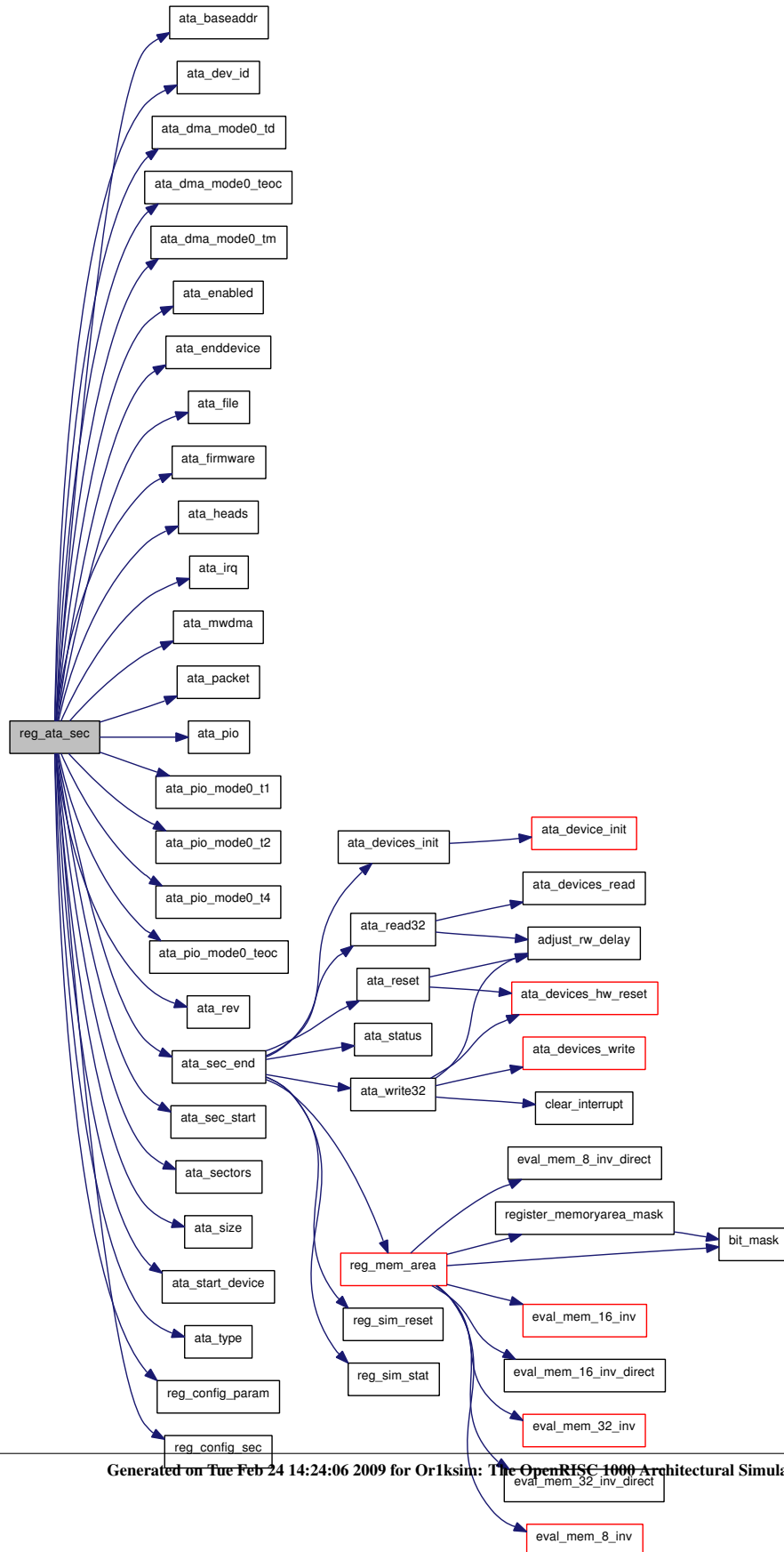

## 6.103 peripheral/channels/channel.c File Reference

```
#include "config.h"  
#include "port.h"  
#include <stdlib.h>  
#include <stdio.h>  
#include <errno.h>  
#include "channel.h"  
#include "fd.h"  
#include "file.h"  
#include "tcp.h"  
#include "tty.h"  
#include "xterm.h"
```

Include dependency graph for channel.c:

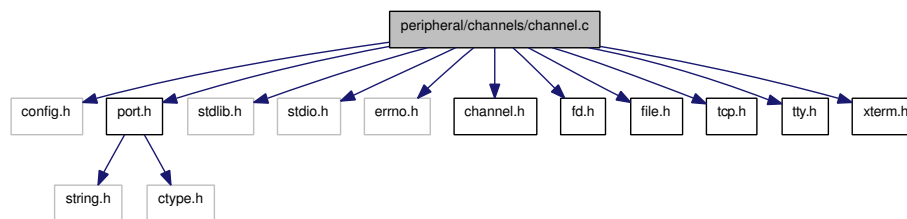

### Data Structures

- struct [channel\\_factory](#)

### Functions

- static struct [channel\\_factory](#) \* [find\\_channel\\_factory](#) (const char \*name)
- struct [channel](#) \* [channel\\_init](#) (const char \*descriptor)
- int [channel\\_open](#) (struct [channel](#) \*channel)
- int [channel\\_read](#) (struct [channel](#) \*channel, char \*buffer, int size)
- int [channel\\_write](#) (struct [channel](#) \*channel, const char \*buffer, int size)
- void [channel\\_close](#) (struct [channel](#) \*channel)

### Variables

- static struct [channel\\_factory](#) [preloaded](#) []
- static struct [channel\\_factory](#) \* [head](#) = &[preloaded](#)[0]

## 6.103.1 Function Documentation

**6.103.1.1** void `channel_close` (`struct channel *channel`)

**6.103.1.2** `struct channel*` `channel_init` (`const char *descriptor`) [read]

Here is the call graph for this function:

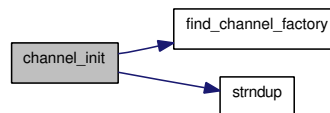

**6.103.1.3** int `channel_open` (`struct channel *channel`)

**6.103.1.4** int `channel_read` (`struct channel *channel`, `char *buffer`, `int size`)

**6.103.1.5** int `channel_write` (`struct channel *channel`, `const char *buffer`, `int size`)

**6.103.1.6** `static struct channel_factory *` `find_channel_factory` (`const char *name`) [static, read]

## 6.103.2 Variable Documentation

**6.103.2.1** `struct channel_factory*` `head = &preloaded[0]` [static]

**6.103.2.2** `struct channel_factory` `preloaded[]` [static]

**Initial value:**

```

{
  {"fd",      &fd_channel_ops,   &preloaded[1]},
  {"file",   &file_channel_ops, &preloaded[2]},
  {"xterm",  &xterm_channel_ops, &preloaded[3]},
  {"tcp",    &tcp_channel_ops,   &preloaded[4]},
  {"tty",    &tty_channel_ops,   NULL}
}
  
```



## 6.104 peripheral/channels/channel.h File Reference

This graph shows which files directly or indirectly include this file:

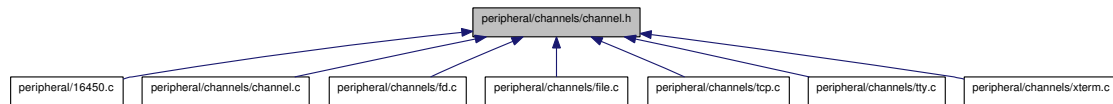

### Data Structures

- struct [channel\\_ops](#)
- struct [channel](#)

### Functions

- struct [channel](#) \* [channel\\_init](#) (const char \*descriptor)
- int [channel\\_open](#) (struct [channel](#) \*channel)
- int [channel\\_read](#) (struct [channel](#) \*channel, char \*buffer, int size)
- int [channel\\_write](#) (struct [channel](#) \*channel, const char \*buffer, int size)
- void [channel\\_close](#) (struct [channel](#) \*channel)

#### 6.104.1 Function Documentation

**6.104.1.1** void [channel\\_close](#) (struct [channel](#) \* *channel*)

**6.104.1.2** struct [channel](#)\* [channel\\_init](#) (const char \* *descriptor*) [read]

Here is the call graph for this function:

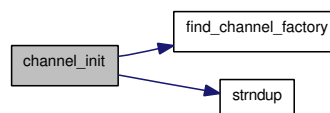

**6.104.1.3** int [channel\\_open](#) (struct [channel](#) \* *channel*)

**6.104.1.4** int [channel\\_read](#) (struct [channel](#) \* *channel*, char \* *buffer*, int *size*)

**6.104.1.5** int [channel\\_write](#) (struct [channel](#) \* *channel*, const char \* *buffer*, int *size*)

## 6.105 peripheral/channels/fd.c File Reference

```
#include "config.h"
#include "port.h"
#include <stdlib.h>
#include <sys/types.h>
#include <sys/time.h>
#include <unistd.h>
#include <errno.h>
#include <stdio.h>
#include "fd.h"
#include "channel.h"
#include "generic.h"
```

Include dependency graph for fd.c:

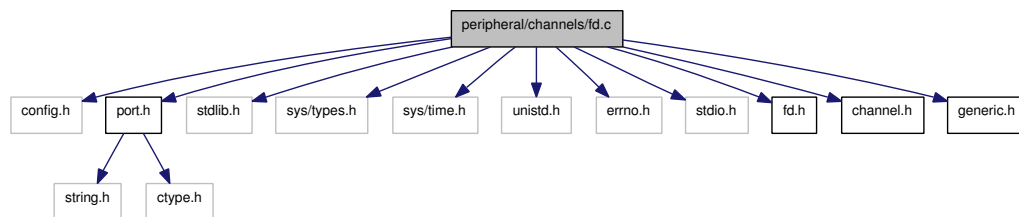

## Functions

- static void \* [fd\\_init](#) (const char \*args)
- static int [fd\\_isok](#) (void \*data)
- static char \* [fd\\_status](#) (void \*data)
- int [fd\\_read](#) (void \*data, char \*buffer, int size)
- int [fd\\_write](#) (void \*data, const char \*buffer, int size)
- static int [fd\\_status\\_fd](#) (int fd, char \*str, int size)

## Variables

- struct [channel\\_ops](#) [fd\\_channel\\_ops](#)

## 6.105.1 Function Documentation

**6.105.1.1** `static void * fd_init (const char * args) [static]`

**6.105.1.2** `static int fd_isok (void * data) [static]`

**6.105.1.3** `int fd_read (void * data, char * buffer, int size)`

**6.105.1.4** `static char * fd_status (void * data) [static]`

Here is the call graph for this function:



**6.105.1.5** `static int fd_status_fd (int fd, char * str, int size) [static]`

**6.105.1.6** `int fd_write (void * data, const char * buffer, int size)`

## 6.105.2 Variable Documentation

**6.105.2.1** `struct channel_ops fd_channel_ops`

**Initial value:**

```
{
    .init    = fd_init,
    .open    = generic_open,
    .close   = generic_close,
    .read    = fd_read,
    .write   = fd_write,
    .free    = generic_free,
    .isok    = fd_isok,
    .status  = fd_status,
}
```

Global data structure representing the operations for communicating through a file descriptor [channel](#)

## 6.106 peripheral/channels/fd.h File Reference

This graph shows which files directly or indirectly include this file:

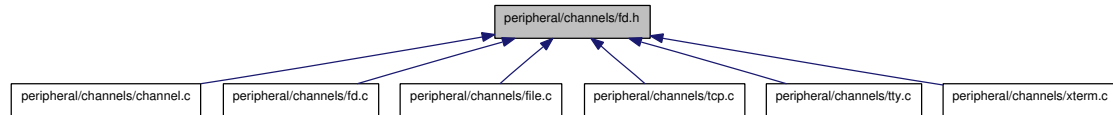

### Data Structures

- struct [fd\\_channel](#)

### Functions

- int [fd\\_read](#) (void \*data, char \*buffer, int size)
- int [fd\\_write](#) (void \*data, const char \*buffer, int size)

### Variables

- struct [channel\\_ops](#) [fd\\_channel\\_ops](#)

#### 6.106.1 Function Documentation

**6.106.1.1** int [fd\\_read](#) (void \* *data*, char \* *buffer*, int *size*)

**6.106.1.2** int [fd\\_write](#) (void \* *data*, const char \* *buffer*, int *size*)

#### 6.106.2 Variable Documentation

**6.106.2.1** struct [channel\\_ops](#) [fd\\_channel\\_ops](#)

Global data structure representing the operations for communicating through a file descriptor [channel](#)

## 6.107 peripheral/channels/file.c File Reference

```
#include "config.h"  
#include "port.h"  
#include <stdlib.h>  
#include <unistd.h>  
#include <errno.h>  
#include <fcntl.h>  
#include "channel.h"  
#include "fd.h"
```

Include dependency graph for file.c:

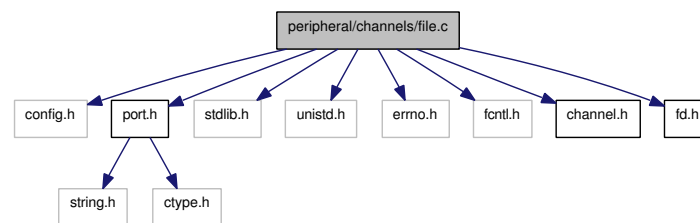

### Data Structures

- struct [file\\_channel](#)

### Functions

- static void \* [file\\_init](#) (const char \*args)
- static int [file\\_open](#) (void \*data)
- static void [file\\_close](#) (void \*data)
- static void [file\\_free](#) (void \*data)

### Variables

- struct [channel\\_ops](#) [file\\_channel\\_ops](#)

## 6.107.1 Function Documentation

**6.107.1.1** `static void file_close (void * data)` [static]

**6.107.1.2** `static void file_free (void * data)` [static]

**6.107.1.3** `static void * file_init (const char * args)` [static]

Here is the call graph for this function:



**6.107.1.4** `static int file_open (void * data)` [static]

## 6.107.2 Variable Documentation

**6.107.2.1** `struct channel_ops file_channel_ops`

**Initial value:**

```
{
    .init = file_init,
    .open = file_open,
    .close = file_close,
    .read = fd_read,
    .write = fd_write,
    .free = file_free,
}
```

Data structure with all the operations for communicating with a file [channel](#)

## 6.108 peripheral/channels/file.h File Reference

This graph shows which files directly or indirectly include this file:

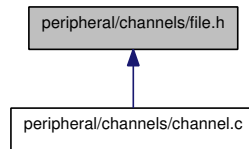

### Variables

- struct [channel\\_ops](#) [file\\_channel\\_ops](#)

#### 6.108.1 Variable Documentation

##### 6.108.1.1 struct [channel\\_ops](#) [file\\_channel\\_ops](#)

Data structure with all the operations for communicating with a file [channel](#)

## 6.109 peripheral/channels/tcp.c File Reference

```
#include "config.h"
#include "port.h"
#include <stdlib.h>
#include <unistd.h>
#include <stdio.h>
#include <sys/types.h>
#include <sys/socket.h>
#include <netinet/in.h>
#include <fcntl.h>
#include <errno.h>
#include "channel.h"
#include "generic.h"
#include "fd.h"
```

Include dependency graph for tcp.c:

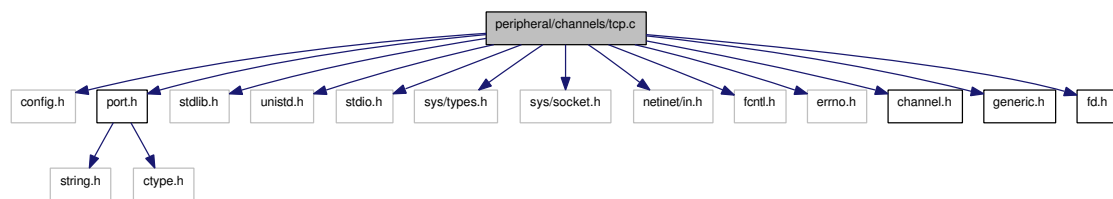

### Data Structures

- struct [tcp\\_channel](#)

### Functions

- static void \* [tcp\\_init](#) (const char \*input)
- static int [tcp\\_open](#) (void \*data)
- static int [tcp\\_read](#) (void \*data, char \*buffer, int size)
- static int [tcp\\_write](#) (void \*data, const char \*buffer, int size)
- static int [wait\\_for\\_tcp\\_connect](#) (struct [tcp\\_channel](#) \*channel)

### Variables

- struct [channel\\_ops](#) [tcp\\_channel\\_ops](#)



## 6.109.1 Function Documentation

**6.109.1.1** `static void * tcp_init (const char * input)` [static]

**6.109.1.2** `static int tcp_open (void * data)` [static]

**6.109.1.3** `static int tcp_read (void * data, char * buffer, int size)` [static]

Here is the call graph for this function:

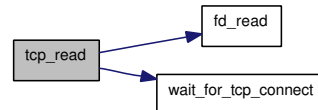

**6.109.1.4** `static int tcp_write (void * data, const char * buffer, int size)` [static]

Here is the call graph for this function:

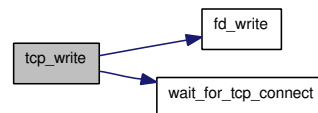

**6.109.1.5** `static int wait_for_tcp_connect (struct tcp_channel * channel)` [static]

## 6.109.2 Variable Documentation

**6.109.2.1** `struct channel_ops tcp_channel_ops`

**Initial value:**

```
{
    .init = tcp_init,
    .open = tcp_open,
    .close = generic_close,
    .read = tcp_read,
    .write = tcp_write,
    .free = generic_free,
}
```

Data structure holding all the operations for a TCP/IP [channel](#)

## 6.110 peripheral/channels/tcp.h File Reference

This graph shows which files directly or indirectly include this file:

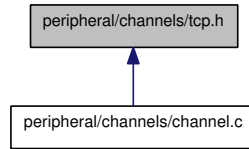

### Variables

- struct [channel\\_ops](#) [tcp\\_channel\\_ops](#)

#### 6.110.1 Variable Documentation

##### 6.110.1.1 struct [channel\\_ops](#) [tcp\\_channel\\_ops](#)

Data structure holding all the operations for a TCP/IP [channel](#)

## 6.111 peripheral/channels/tty.c File Reference

```
#include "config.h"
#include "port.h"
#include <stdlib.h>
#include <unistd.h>
#include <termios.h>
#include <stdio.h>
#include <fcntl.h>
#include "channel.h"
#include "generic.h"
#include "fd.h"
```

Include dependency graph for tty.c:

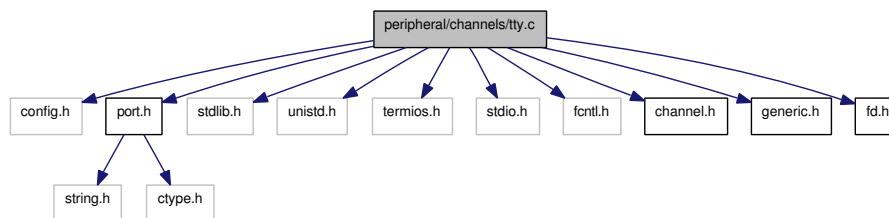

### Data Structures

- struct [tty\\_channel](#)

### Defines

- #define [DEFAULT\\_BAUD](#) B19200
- #define [DEFAULT\\_TTY\\_DEVICE](#) "/dev/ttyS0"

### Functions

- static void \* [tty\\_init](#) (const char \*input)
- static int [tty\\_open](#) (void \*data)
- static int [parse\\_baud](#) (char \*baud\_string)

### Variables

- struct {
  - char \* [name](#)
  - int [value](#)
 } [baud\\_table](#) []
- struct [channel\\_ops](#) [tty\\_channel\\_ops](#)

### 6.111.1 Define Documentation

6.111.1.1 `#define DEFAULT_BAUD B19200`

6.111.1.2 `#define DEFAULT_TTY_DEVICE "/dev/ttyS0"`

### 6.111.2 Function Documentation

6.111.2.1 `static int parse_baud (char * baud_string)` [static]

6.111.2.2 `static void * tty_init (const char * input)` [static]

Here is the call graph for this function:



6.111.2.3 `static int tty_open (void * data)` [static]

### 6.111.3 Variable Documentation

6.111.3.1 `struct { ... } baud_table[]` [static]

Table of Baud rates

6.111.3.2 `char* name`

6.111.3.3 `struct channel_ops tty_channel_ops`

**Initial value:**

```
{
    .init = tty_init,
    .open = tty_open,
    .close = generic_close,
    .read = fd_read,
    .write = fd_write,
    .free = generic_free,
}
```

Global data structure representing the operations on a TTY [channel](#)

6.111.3.4 `int value`

## 6.112 peripheral/channels/tty.h File Reference

This graph shows which files directly or indirectly include this file:

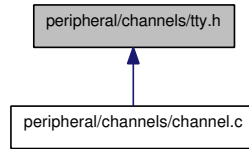

### Variables

- struct [channel\\_ops](#) [tty\\_channel\\_ops](#)

#### 6.112.1 Variable Documentation

##### 6.112.1.1 struct [channel\\_ops](#) [tty\\_channel\\_ops](#)

Global data structure representing the operations on a TTY [channel](#)

## 6.113 peripheral/channels/xterm.c File Reference

```
#include "config.h"
#include "port.h"
#include <stdlib.h>
#include <unistd.h>
#include <signal.h>
#include <termios.h>
#include <errno.h>
#include <stdio.h>
#include <fcntl.h>
#include <sys/types.h>
#include <sys/wait.h>
#include "channel.h"
#include "generic.h"
#include "fd.h"
```

Include dependency graph for xterm.c:

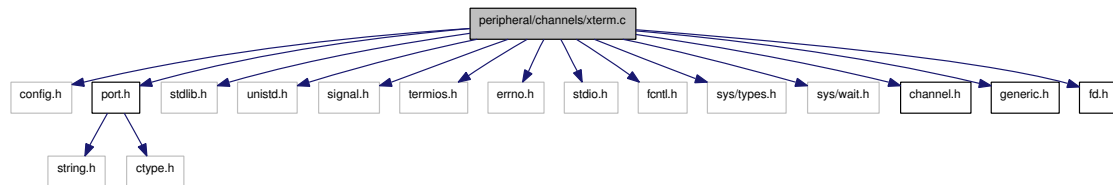

### Data Structures

- struct [xterm\\_channel](#)

### Defines

- #define [MAX\\_XTERM\\_ARGS](#) 100

### Functions

- static void [xterm\\_close](#) (void \*data)
- static void \* [xterm\\_init](#) (const char \*input)
- static int [xterm\\_open](#) (void \*data)
- static char \* [basename](#) (const char \*filename)

### Variables

- struct [channel\\_ops](#) [xterm\\_channel\\_ops](#)

## 6.113.1 Define Documentation

### 6.113.1.1 #define MAX\_XTERM\_ARGS 100

## 6.113.2 Function Documentation

### 6.113.2.1 static char\* basename (const char \*filename) [static]

### 6.113.2.2 static void xterm\_close (void \*data) [static]

### 6.113.2.3 static void \* xterm\_init (const char \*input) [static]

### 6.113.2.4 static int xterm\_open (void \*data) [static]

Here is the call graph for this function:



## 6.113.3 Variable Documentation

### 6.113.3.1 struct channel\_ops xterm\_channel\_ops

**Initial value:**

```
{
    .init = xterm_init,
    .open = xterm_open,
    .close = xterm_close,
    .read = fd_read,
    .write = fd_write,
    .free = generic_free,
}
```

Global data structure with the xterm interface functions

## 6.114 peripheral/channels/xterm.h File Reference

This graph shows which files directly or indirectly include this file:

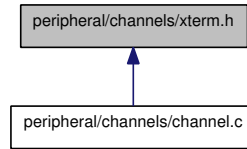

### Variables

- struct [channel\\_ops](#) [xterm\\_channel\\_ops](#)

#### 6.114.1 Variable Documentation

##### 6.114.1.1 struct [channel\\_ops](#) [xterm\\_channel\\_ops](#)

Global data structure with the xterm interface functions



## 6.115 peripheral/crc32.c File Reference

```
#include "crc32.h"
```

Include dependency graph for crc32.c:

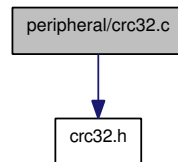

### Functions

- unsigned long [crc32](#) (const void \*buf, unsigned len)
- void [crc32\\_init](#) (unsigned long \*value)
- void [crc32\\_feed\\_bytes](#) (unsigned long \*value, const void \*buf, unsigned len)
- void [crc32\\_close](#) (unsigned long \*value)

### Variables

- static unsigned long [crc32\\_table](#) [256]

#### 6.115.1 Function Documentation

##### 6.115.1.1 unsigned long [crc32](#) (const void \* buf, unsigned len)

Here is the call graph for this function:

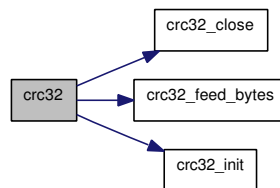

##### 6.115.1.2 void [crc32\\_close](#) (unsigned long \* value)

##### 6.115.1.3 void [crc32\\_feed\\_bytes](#) (unsigned long \* value, const void \* buf, unsigned len)

##### 6.115.1.4 void [crc32\\_init](#) (unsigned long \* value)

#### 6.115.2 Variable Documentation

##### 6.115.2.1 unsigned long [crc32\\_table](#)[256] [static]

## 6.116 peripheral/crc32.h File Reference

This graph shows which files directly or indirectly include this file:

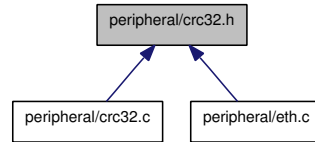

### Functions

- unsigned long [crc32](#) (const void \*buf, unsigned len)
- void [crc32\\_init](#) (unsigned long \*value)
- void [crc32\\_feed\\_bytes](#) (unsigned long \*value, const void \*buf, unsigned len)
- void [crc32\\_close](#) (unsigned long \*value)

#### 6.116.1 Function Documentation

##### 6.116.1.1 unsigned long [crc32](#) (const void \* *buf*, unsigned *len*)

Here is the call graph for this function:

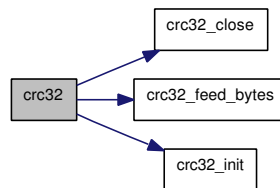

##### 6.116.1.2 void [crc32\\_close](#) (unsigned long \* *value*)

##### 6.116.1.3 void [crc32\\_feed\\_bytes](#) (unsigned long \* *value*, const void \* *buf*, unsigned *len*)

##### 6.116.1.4 void [crc32\\_init](#) (unsigned long \* *value*)

## 6.117 peripheral/dma-defs.h File Reference

This graph shows which files directly or indirectly include this file:

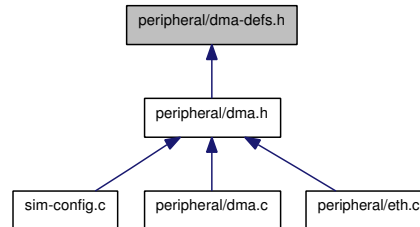

### Defines

- #define [DMA\\_NUM\\_CHANNELS](#) 31
- #define [DMA\\_ADDR\\_SPACE](#) 0x400
- #define [DMA\\_CSR](#) 0x00
- #define [DMA\\_INT\\_MSK\\_A](#) 0x04
- #define [DMA\\_INT\\_MSK\\_B](#) 0x08
- #define [DMA\\_INT\\_SRC\\_A](#) 0x0C
- #define [DMA\\_INT\\_SRC\\_B](#) 0x10
- #define [DMA\\_CH\\_BASE](#) 0x20
- #define [DMA\\_CH\\_SIZE](#) 0x20
- #define [DMA\\_CH\\_CSR](#) 0x00
- #define [DMA\\_CH\\_SZ](#) 0x04
- #define [DMA\\_CH\\_A0](#) 0x08
- #define [DMA\\_CH\\_AM0](#) 0x0C
- #define [DMA\\_CH\\_A1](#) 0x10
- #define [DMA\\_CH\\_AM1](#) 0x14
- #define [DMA\\_CH\\_DESC](#) 0x18
- #define [DMA\\_CH\\_SWPTR](#) 0x1C
- #define [DMA\\_CSR\\_PAUSE\\_OFFSET](#) 0
- #define [DMA\\_CH\\_CSR\\_CH\\_EN\\_OFFSET](#) 0
- #define [DMA\\_CH\\_CSR\\_DST\\_SEL\\_OFFSET](#) 1
- #define [DMA\\_CH\\_CSR\\_SRC\\_SEL\\_OFFSET](#) 2
- #define [DMA\\_CH\\_CSR\\_INC\\_DST\\_OFFSET](#) 3
- #define [DMA\\_CH\\_CSR\\_INC\\_SRC\\_OFFSET](#) 4
- #define [DMA\\_CH\\_CSR\\_MODE\\_OFFSET](#) 5
- #define [DMA\\_CH\\_CSR\\_ARS\\_OFFSET](#) 6
- #define [DMA\\_CH\\_CSR\\_USE\\_ED\\_OFFSET](#) 7
- #define [DMA\\_CH\\_CSR\\_SZ\\_WB\\_OFFSET](#) 8
- #define [DMA\\_CH\\_CSR\\_STOP\\_OFFSET](#) 9
- #define [DMA\\_CH\\_CSR\\_BUSY\\_OFFSET](#) 10
- #define [DMA\\_CH\\_CSR\\_DONE\\_OFFSET](#) 11
- #define [DMA\\_CH\\_CSR\\_ERR\\_OFFSET](#) 12
- #define [DMA\\_CH\\_CSR\\_PRIORITY\\_OFFSET](#) 13
- #define [DMA\\_CH\\_CSR\\_PRIORITY\\_WIDTH](#) 3
- #define [DMA\\_CH\\_CSR\\_REST\\_EN\\_OFFSET](#) 16
- #define [DMA\\_CH\\_CSR\\_INE\\_ERR\\_OFFSET](#) 17

- #define DMA\_CH\_CSR\_INE\_DONE\_OFFSET 18
- #define DMA\_CH\_CSR\_INE\_CHK\_DONE\_OFFSET 19
- #define DMA\_CH\_CSR\_INT\_ERR\_OFFSET 20
- #define DMA\_CH\_CSR\_INT\_DONE\_OFFSET 21
- #define DMA\_CH\_CSR\_INT\_CHUNK\_DONE\_OFFSET 22
- #define DMA\_CH\_CSR\_RESERVED\_OFFSET 23
- #define DMA\_CH\_CSR\_RESERVED\_WIDTH 9
- #define DMA\_CH\_CSR\_WRITE\_MASK 0x000FE3FF
- #define DMA\_CH\_SZ\_TOT\_SZ\_OFFSET 0
- #define DMA\_CH\_SZ\_TOT\_SZ\_WIDTH 12
- #define DMA\_CH\_SZ\_CHK\_SZ\_OFFSET 16
- #define DMA\_CH\_SZ\_CHK\_SZ\_WIDTH 9
- #define DMA\_CH\_A0\_ADDR\_OFFSET 2
- #define DMA\_CH\_A0\_ADDR\_WIDTH 30
- #define DMA\_CH\_A1\_ADDR\_OFFSET 2
- #define DMA\_CH\_A1\_ADDR\_WIDTH 30
- #define DMA\_CH\_AM0\_MASK\_OFFSET 4
- #define DMA\_CH\_AM0\_MASK\_WIDTH 28
- #define DMA\_CH\_AM1\_MASK\_OFFSET 4
- #define DMA\_CH\_AM1\_MASK\_WIDTH 28
- #define DMA\_CH\_DESC\_ADDR\_OFFSET 2
- #define DMA\_CH\_DESC\_ADDR\_WIDTH 30
- #define DMA\_CH\_SWPTR\_PTR\_OFFSET 2
- #define DMA\_CH\_SWPTR\_PTR\_WIDTH 29
- #define DMA\_CH\_SWPTR\_EN\_OFFSET 31
- #define DMA\_DESC\_CSR 0x00
- #define DMA\_DESC\_ADR0 0x04
- #define DMA\_DESC\_ADR1 0x08
- #define DMA\_DESC\_NEXT 0x0C
- #define DMA\_DESC\_CSR\_EOL\_OFFSET 20
- #define DMA\_DESC\_CSR\_INC\_SRC\_OFFSET 19
- #define DMA\_DESC\_CSR\_INC\_DST\_OFFSET 18
- #define DMA\_DESC\_CSR\_SRC\_SEL\_OFFSET 17
- #define DMA\_DESC\_CSR\_DST\_SEL\_OFFSET 16
- #define DMA\_DESC\_CSR\_TOT\_SZ\_OFFSET 0
- #define DMA\_DESC\_CSR\_TOT\_SZ\_WIDTH 12

## 6.117.1 Define Documentation

6.117.1.1 `#define DMA_ADDR_SPACE 0x400`

6.117.1.2 `#define DMA_CH_A0 0x08`

6.117.1.3 `#define DMA_CH_A0_ADDR_OFFSET 2`

6.117.1.4 `#define DMA_CH_A0_ADDR_WIDTH 30`

6.117.1.5 `#define DMA_CH_A1 0x10`

6.117.1.6 `#define DMA_CH_A1_ADDR_OFFSET 2`

6.117.1.7 `#define DMA_CH_A1_ADDR_WIDTH 30`

6.117.1.8 `#define DMA_CH_AM0 0x0C`

6.117.1.9 `#define DMA_CH_AM0_MASK_OFFSET 4`

6.117.1.10 `#define DMA_CH_AM0_MASK_WIDTH 28`

6.117.1.11 `#define DMA_CH_AM1 0x14`

6.117.1.12 `#define DMA_CH_AM1_MASK_OFFSET 4`

6.117.1.13 `#define DMA_CH_AM1_MASK_WIDTH 28`

6.117.1.14 `#define DMA_CH_BASE 0x20`

Offset of first [channel](#) registers



- 6.117.1.15 `#define DMA_CH_CSR 0x00`
- 6.117.1.16 `#define DMA_CH_CSR_ARS_OFFSET 6`
- 6.117.1.17 `#define DMA_CH_CSR_BUSY_OFFSET 10`
- 6.117.1.18 `#define DMA_CH_CSR_CH_EN_OFFSET 0`
- 6.117.1.19 `#define DMA_CH_CSR_DONE_OFFSET 11`
- 6.117.1.20 `#define DMA_CH_CSR_DST_SEL_OFFSET 1`
- 6.117.1.21 `#define DMA_CH_CSR_ERR_OFFSET 12`
- 6.117.1.22 `#define DMA_CH_CSR_INC_DST_OFFSET 3`
- 6.117.1.23 `#define DMA_CH_CSR_INC_SRC_OFFSET 4`
- 6.117.1.24 `#define DMA_CH_CSR_INE_CHK_DONE_OFFSET 19`
- 6.117.1.25 `#define DMA_CH_CSR_INE_DONE_OFFSET 18`
- 6.117.1.26 `#define DMA_CH_CSR_INE_ERR_OFFSET 17`
- 6.117.1.27 `#define DMA_CH_CSR_INT_CHUNK_DONE_OFFSET 22`
- 6.117.1.28 `#define DMA_CH_CSR_INT_DONE_OFFSET 21`
- 6.117.1.29 `#define DMA_CH_CSR_INT_ERR_OFFSET 20`
- 6.117.1.30 `#define DMA_CH_CSR_MODE_OFFSET 5`
- 6.117.1.31 `#define DMA_CH_CSR_PRIORITY_OFFSET 13`
- 6.117.1.32 `#define DMA_CH_CSR_PRIORITY_WIDTH 3`
- 6.117.1.33 `#define DMA_CH_CSR_RESERVED_OFFSET 23`
- 6.117.1.34 `#define DMA_CH_CSR_RESERVED_WIDTH 9`
- 6.117.1.35 `#define DMA_CH_CSR_REST_EN_OFFSET 16`
- 6.117.1.36 `#define DMA_CH_CSR_SRC_SEL_OFFSET 2`
- 6.117.1.37 `#define DMA_CH_CSR_STOP_OFFSET 9`
- 6.117.1.38 `#define DMA_CH_CSR_SZ_WB_OFFSET 8`
- 6.117.1.39 `#define DMA_CH_CSR_USE_ED_OFFSET 7`
- 6.117.1.40 `#define DMA_CH_CSR_WRITE_MASK 0x000FE3FF`
- 6.117.1.41 `#define DMA_CH_DESC 0x18`
- 6.117.1.42 `#define DMA_CH_DESC_ADDR_OFFSET 2`
- 6.117.1.43 `#define DMA_CH_DESC_ADDR_WIDTH 30`
- 6.117.1.44 `#define DMA_CH_SIZE 0x20`

---

Generated on Tue Feb 27 19:24:06 2007 for OplSim. The OpenRISC 1000 Architectural Simulator by Doxygen





- 6.117.1.45 `#define DMA_CH_SWPTR 0x1C`
- 6.117.1.46 `#define DMA_CH_SWPTR_EN_OFFSET 31`
- 6.117.1.47 `#define DMA_CH_SWPTR_PTR_OFFSET 2`
- 6.117.1.48 `#define DMA_CH_SWPTR_PTR_WIDTH 29`
- 6.117.1.49 `#define DMA_CH_SZ 0x04`
- 6.117.1.50 `#define DMA_CH_SZ_CHK_SZ_OFFSET 16`
- 6.117.1.51 `#define DMA_CH_SZ_CHK_SZ_WIDTH 9`
- 6.117.1.52 `#define DMA_CH_SZ_TOT_SZ_OFFSET 0`
- 6.117.1.53 `#define DMA_CH_SZ_TOT_SZ_WIDTH 12`
- 6.117.1.54 `#define DMA_CSR 0x00`
- 6.117.1.55 `#define DMA_CSR_PAUSE_OFFSET 0`
- 6.117.1.56 `#define DMA_DESC_ADR0 0x04`
- 6.117.1.57 `#define DMA_DESC_ADR1 0x08`
- 6.117.1.58 `#define DMA_DESC_CSR 0x00`
- 6.117.1.59 `#define DMA_DESC_CSR_DST_SEL_OFFSET 16`
- 6.117.1.60 `#define DMA_DESC_CSR_EOL_OFFSET 20`
- 6.117.1.61 `#define DMA_DESC_CSR_INC_DST_OFFSET 18`
- 6.117.1.62 `#define DMA_DESC_CSR_INC_SRC_OFFSET 19`
- 6.117.1.63 `#define DMA_DESC_CSR_SRC_SEL_OFFSET 17`
- 6.117.1.64 `#define DMA_DESC_CSR_TOT_SZ_OFFSET 0`
- 6.117.1.65 `#define DMA_DESC_CSR_TOT_SZ_WIDTH 12`
- 6.117.1.66 `#define DMA_DESC_NEXT 0x0C`
- 6.117.1.67 `#define DMA_INT_MSK_A 0x04`
- 6.117.1.68 `#define DMA_INT_MSK_B 0x08`
- 6.117.1.69 `#define DMA_INT_SRC_A 0x0C`
- 6.117.1.70 `#define DMA_INT_SRC_B 0x10`
- 6.117.1.71 `#define DMA_NUM_CHANNELS 31`

## 6.118 peripheral/dma.c File Reference

```
#include "config.h"
#include "port.h"
#include <stdlib.h>
#include "dma.h"
#include "fields.h"
#include "abstract.h"
#include "sched.h"
#include "pic.h"
#include "toplevel-support.h"
#include "sim-cmd.h"
```

Include dependency graph for dma.c:

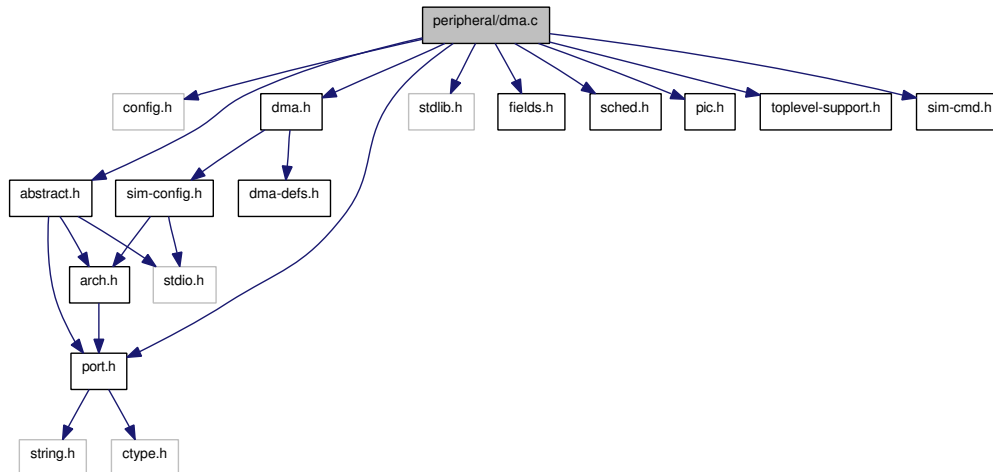

### Defines

- #define [CHANNEL\\_ND\\_I](#)(ch) (TEST\_FLAG(ch → regs.csr,DMA\_CH\_CSR,MODE) && TEST\_FLAG(ch → regs.csr,DMA\_CH\_CSR,USE\_ED) && ch → dma\_nd\_i)

### Functions

- static unsigned long [dma\\_read\\_ch\\_csr](#) (struct [dma\\_channel](#) \*channel)
- static void [dma\\_write\\_ch\\_csr](#) (struct [dma\\_channel](#) \*channel, unsigned long value)
- static void [dma\\_load\\_descriptor](#) (struct [dma\\_channel](#) \*channel)
- static void [dma\\_init\\_transfer](#) (struct [dma\\_channel](#) \*channel)
- static void [dma\\_channel\\_terminate\\_transfer](#) (struct [dma\\_channel](#) \*channel, int generate\_interrupt)
- static void [dma\\_channel\\_clock](#) (void \*dat)
- static void [masked\\_increase](#) (oraddr\_t \*value, unsigned long mask)
- static void [dma\\_reset](#) (void \*dat)

- static void [dma\\_status](#) (void \*dat)
- static uint32\_t [dma\\_read32](#) (oraddr\_t addr, void \*dat)
- static void [dma\\_write32](#) (oraddr\_t addr, uint32\_t value, void \*dat)
- void [set\\_dma\\_req\\_i](#) (struct dma\_channel \*channel)
- void [clear\\_dma\\_req\\_i](#) (struct dma\_channel \*channel)
- void [set\\_dma\\_nd\\_i](#) (struct dma\_channel \*channel)
- void [clear\\_dma\\_nd\\_i](#) (struct dma\_channel \*channel)
- unsigned [check\\_dma\\_ack\\_o](#) (struct dma\_channel \*channel)
- struct dma\_channel \* [find\\_dma\\_controller\\_ch](#) (unsigned controller, unsigned channel)
- static void [dma\\_baseaddr](#) (union param\_val val, void \*dat)
- static void [dma\\_irq](#) (union param\_val val, void \*dat)
- static void [dma\\_vapi\\_id](#) (union param\_val val, void \*dat)
- static void [dma\\_enabled](#) (union param\_val val, void \*dat)
- static void \* [dma\\_sec\\_start](#) ()
- static void [dma\\_sec\\_end](#) (void \*dat)
- void [reg\\_dma\\_sec](#) (void)

## Variables

- static struct [dma\\_controller](#) \* [dmas](#) = NULL

## 6.118.1 Define Documentation

6.118.1.1 `#define CHANNEL_ND_I(ch)` (`TEST_FLAG(ch → regs.csr,DMA_CH_CSR,MODE)`  
&& `TEST_FLAG(ch → regs.csr,DMA_CH_CSR,USE_ED)` && `ch → dma_nd_i`)

## 6.118.2 Function Documentation

6.118.2.1 `unsigned check_dma_ack_o` (`struct dma_channel * channel`)

6.118.2.2 `void clear_dma_nd_i` (`struct dma_channel * channel`)

6.118.2.3 `void clear_dma_req_i` (`struct dma_channel * channel`)

6.118.2.4 `static void dma_baseaddr` (`union param_val val, void * dat`) [`static`]

6.118.2.5 `static void dma_channel_clock` (`void * dat`) [`static`]

Here is the call graph for this function:

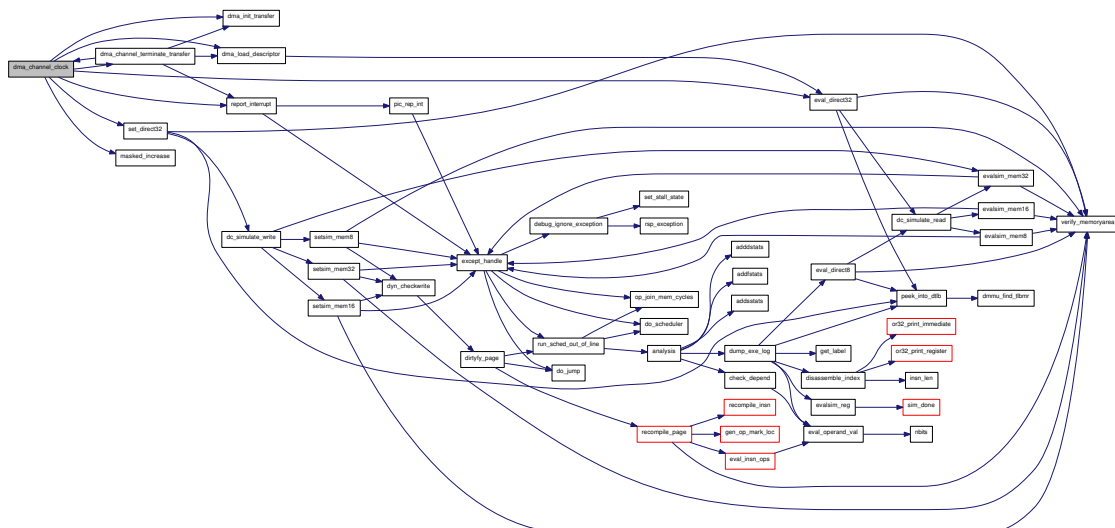



**6.118.2.11** `static uint32_t dma_read32 (oraddr_t addr, void * dat)` [static]

Here is the call graph for this function:

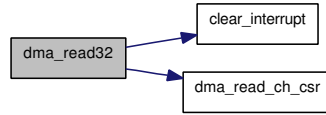

**6.118.2.12** `static unsigned long dma_read_ch_csr (struct dma_channel * channel)` [static]

**6.118.2.13** `static void dma_reset (void * dat)` [static]

**6.118.2.14** `static void dma_sec_end (void * dat)` [static]

Here is the call graph for this function:

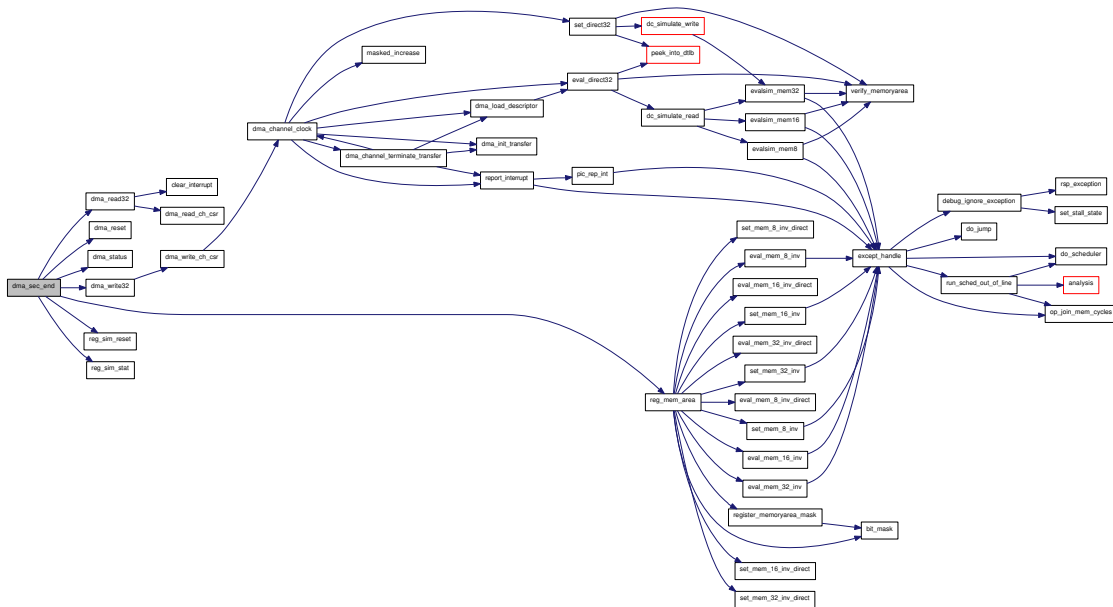

**6.118.2.15** `static void* dma_sec_start ()` [static]

Initialize a new DMA configuration  
 ALL parameters are set explicitly to default values.



**6.118.2.20** `struct dma_channel* find_dma_controller_ch (unsigned controller, unsigned channel)`  
[read]

**6.118.2.21** `static void masked_increase (oraddr_t * value, unsigned long mask)` [static]

**6.118.2.22** `void reg_dma_sec (void)`

Here is the call graph for this function:

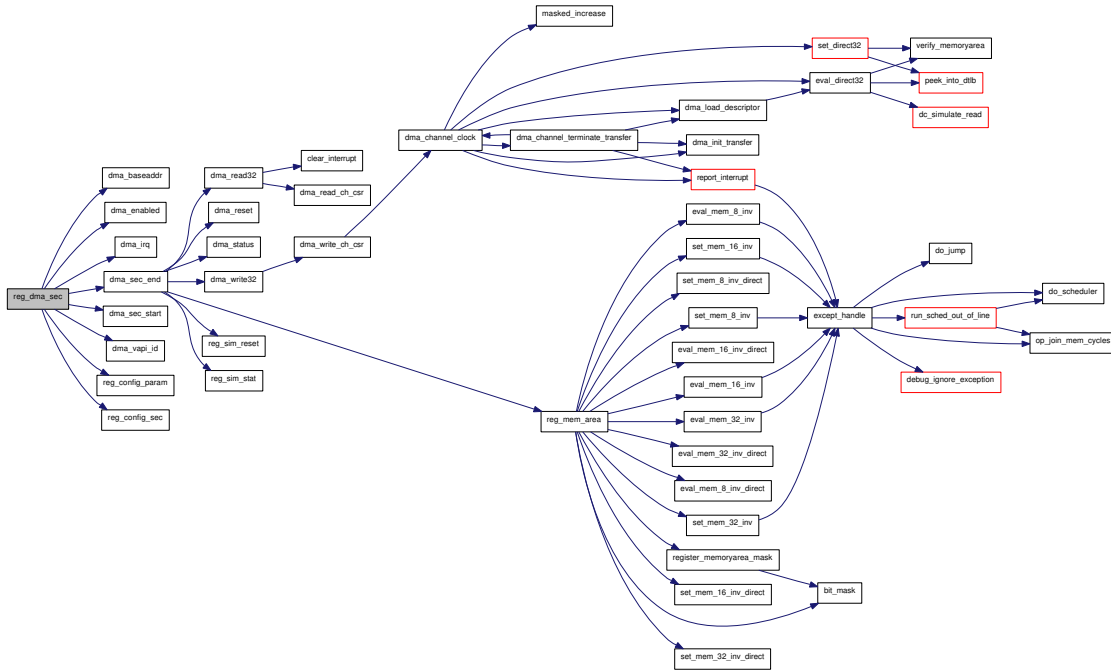

**6.118.2.23** `void set_dma_nd_i (struct dma_channel * channel)`

**6.118.2.24** `void set_dma_req_i (struct dma_channel * channel)`

### 6.118.3 Variable Documentation

**6.118.3.1** `struct dma_controller* dmas = NULL` [static]



## 6.119 peripheral/dma.h File Reference

```
#include "dma-defs.h"
```

```
#include "sim-config.h"
```

Include dependency graph for dma.h:

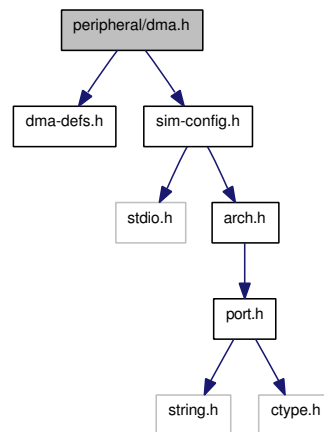

This graph shows which files directly or indirectly include this file:

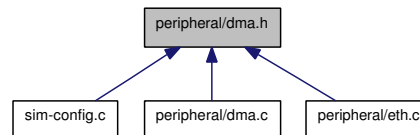

### Data Structures

- struct [dma\\_channel](#)
- struct [dma\\_controller](#)

### Functions

- void [set\\_dma\\_req\\_i](#) (struct [dma\\_channel](#) \*channel)
- void [clear\\_dma\\_req\\_i](#) (struct [dma\\_channel](#) \*channel)
- void [set\\_dma\\_nd\\_i](#) (struct [dma\\_channel](#) \*channel)
- void [clear\\_dma\\_nd\\_i](#) (struct [dma\\_channel](#) \*channel)
- unsigned [check\\_dma\\_ack\\_o](#) (struct [dma\\_channel](#) \*channel)
- struct [dma\\_channel](#) \* [find\\_dma\\_controller\\_ch](#) (unsigned controller, unsigned channel)
- void [reg\\_dma\\_sec](#) ()

## 6.119.1 Function Documentation

6.119.1.1 unsigned check\_dma\_ack\_o (struct dma\_channel \* channel)

6.119.1.2 void clear\_dma\_nd\_i (struct dma\_channel \* channel)

6.119.1.3 void clear\_dma\_req\_i (struct dma\_channel \* channel)

6.119.1.4 struct dma\_channel\* find\_dma\_controller\_ch (unsigned controller, unsigned channel)  
[read]

6.119.1.5 void reg\_dma\_sec ()

Here is the call graph for this function:

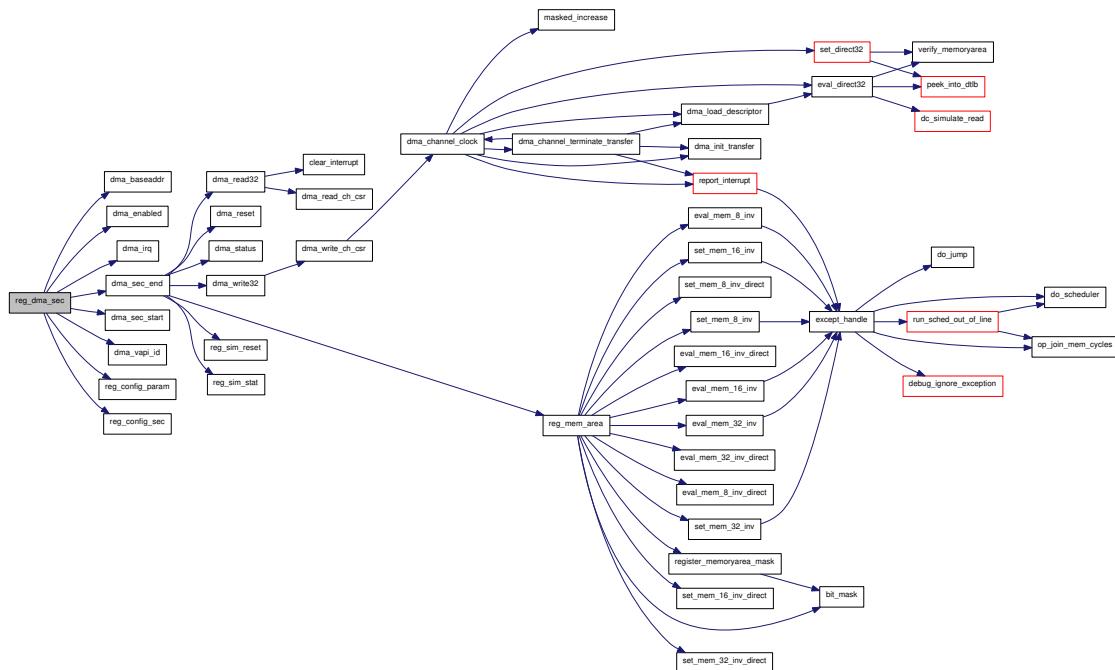

6.119.1.6 void set\_dma\_nd\_i (struct dma\_channel \* channel)

6.119.1.7 void set\_dma\_req\_i (struct dma\_channel \* channel)

## 6.120 peripheral/eth.c File Reference

```

#include "config.h"
#include "port.h"
#include <stdlib.h>
#include <stdio.h>
#include <sys/types.h>
#include <sys/stat.h>
#include <fcntl.h>
#include <sys/poll.h>
#include <sys/time.h>
#include <unistd.h>
#include <errno.h>
#include <netinet/in.h>
#include <sys/ioctl.h>
#include <sys/socket.h>
#include <net/if.h>
#include "arch.h"
#include "abstract.h"
#include "eth.h"
#include "dma.h"
#include "sim-config.h"
#include "fields.h"
#include "crc32.h"
#include "vapi.h"
#include "pic.h"
#include "sched.h"
#include "toplevel-support.h"
#include "sim-cmd.h"

```

Include dependency graph for eth.c:

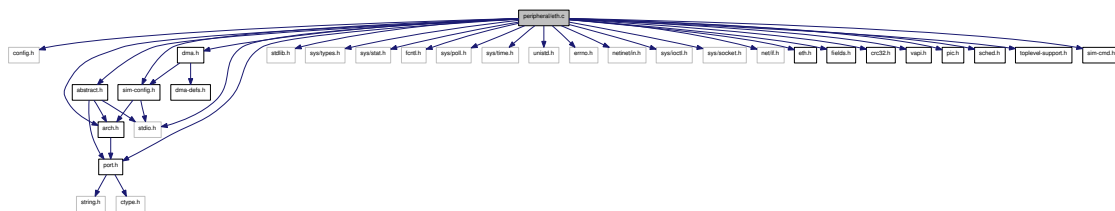

## Data Structures

- struct [ether\\_addr](#)
- struct [ether\\_header](#)
- struct [eth\\_device](#)

## Defines

- #define [ETH\\_ADDR\\_SPACE](#) 0x1000
- #define [ETH\\_MODER](#) (4 \* 0x00)
- #define [ETH\\_INT\\_SOURCE](#) (4 \* 0x01)
- #define [ETH\\_INT\\_MASK](#) (4 \* 0x02)
- #define [ETH\\_IPGT](#) (4 \* 0x03)
- #define [ETH\\_IPGR1](#) (4 \* 0x04)
- #define [ETH\\_IPGR2](#) (4 \* 0x05)
- #define [ETH\\_PACKETLEN](#) (4 \* 0x06)
- #define [ETH\\_COLLCONF](#) (4 \* 0x07)
- #define [ETH\\_TX\\_BD\\_NUM](#) (4 \* 0x08)
- #define [ETH\\_CTRLMODER](#) (4 \* 0x09)
- #define [ETH\\_MIIMODER](#) (4 \* 0x0A)
- #define [ETH\\_MIICOMMAND](#) (4 \* 0x0B)
- #define [ETH\\_MIIADDRESS](#) (4 \* 0x0C)
- #define [ETH\\_MIITX\\_DATA](#) (4 \* 0x0D)
- #define [ETH\\_MIIRX\\_DATA](#) (4 \* 0x0E)
- #define [ETH\\_MIISTATUS](#) (4 \* 0x0F)
- #define [ETH\\_MAC\\_ADDR0](#) (4 \* 0x10)
- #define [ETH\\_MAC\\_ADDR1](#) (4 \* 0x11)
- #define [ETH\\_HASH0](#) (4 \* 0x12)
- #define [ETH\\_HASH1](#) (4 \* 0x13)
- #define [ETH\\_BD\\_BASE](#) 0x400
- #define [ETH\\_BD\\_COUNT](#) 0x100
- #define [ETH\\_BD\\_SPACE](#) (4 \* ETH\_BD\_COUNT)
- #define [ETH\\_DMA\\_RX\\_TX](#) 0x800
- #define [ETH\\_MODER\\_DMAEN\\_OFFSET](#) 17
- #define [ETH\\_MODER\\_RECSCALL\\_OFFSET](#) 16
- #define [ETH\\_MODER\\_PAD\\_OFFSET](#) 15
- #define [ETH\\_MODER\\_HUGEN\\_OFFSET](#) 14
- #define [ETH\\_MODER\\_CRCEN\\_OFFSET](#) 13
- #define [ETH\\_MODER\\_DLYCRCEN\\_OFFSET](#) 12
- #define [ETH\\_MODER\\_RST\\_OFFSET](#) 11
- #define [ETH\\_MODER\\_FULLD\\_OFFSET](#) 10
- #define [ETH\\_MODER\\_EXDFREN\\_OFFSET](#) 9
- #define [ETH\\_MODER\\_NOBCKOF\\_OFFSET](#) 8
- #define [ETH\\_MODER\\_LOOPBCK\\_OFFSET](#) 7
- #define [ETH\\_MODER\\_IFG\\_OFFSET](#) 6
- #define [ETH\\_MODER\\_PRO\\_OFFSET](#) 5
- #define [ETH\\_MODER\\_IAM\\_OFFSET](#) 4
- #define [ETH\\_MODER\\_BRO\\_OFFSET](#) 3
- #define [ETH\\_MODER\\_NOPRE\\_OFFSET](#) 2
- #define [ETH\\_MODER\\_TXEN\\_OFFSET](#) 1

- #define ETH\_MODER\_RXEN\_OFFSET 0
- #define ETH\_INT\_SOURCE\_RXC\_OFFSET 6
- #define ETH\_INT\_SOURCE\_TXC\_OFFSET 5
- #define ETH\_INT\_SOURCE\_BUSY\_OFFSET 4
- #define ETH\_INT\_SOURCE\_RXE\_OFFSET 3
- #define ETH\_INT\_SOURCE\_RXB\_OFFSET 2
- #define ETH\_INT\_SOURCE\_TXE\_OFFSET 1
- #define ETH\_INT\_SOURCE\_TXB\_OFFSET 0
- #define ETH\_INT\_MASK\_RXC\_M\_OFFSET 6
- #define ETH\_INT\_MASK\_TXC\_M\_OFFSET 5
- #define ETH\_INT\_MASK\_BUSY\_M\_OFFSET 4
- #define ETH\_INT\_MASK\_RXE\_M\_OFFSET 3
- #define ETH\_INT\_MASK\_RXB\_M\_OFFSET 2
- #define ETH\_INT\_MASK\_TXE\_M\_OFFSET 1
- #define ETH\_INT\_MASK\_TXB\_M\_OFFSET 0
- #define ETH\_PACKETLEN\_MINFL\_OFFSET 16
- #define ETH\_PACKETLEN\_MINFL\_WIDTH 16
- #define ETH\_PACKETLEN\_MAXFL\_OFFSET 0
- #define ETH\_PACKETLEN\_MAXFL\_WIDTH 16
- #define ETH\_COLLCONF\_MAXRET\_OFFSET 16
- #define ETH\_COLLCONF\_MAXRET\_WIDTH 4
- #define ETH\_COLLCONF\_COLLVALID\_OFFSET 0
- #define ETH\_COLLCONF\_COLLVALID\_WIDTH 6
- #define ETH\_CMODER\_TXFLOW\_OFFSET 2
- #define ETH\_CMODER\_RXFLOW\_OFFSET 1
- #define ETH\_CMODER\_PASSALL\_OFFSET 0
- #define ETH\_MIIMODER\_MRST\_OFFSET 9
- #define ETH\_MIIMODER\_NOPRE\_OFFSET 8
- #define ETH\_MIIMODER\_CLKDIV\_OFFSET 0
- #define ETH\_MIIMODER\_CLKDIV\_WIDTH 8
- #define ETH\_MIICOMM\_WCDATA\_OFFSET 2
- #define ETH\_MIICOMM\_RSTAT\_OFFSET 1
- #define ETH\_MIICOMM\_SCANS\_OFFSET 0
- #define ETH\_MIIADDR\_RGAD\_OFFSET 8
- #define ETH\_MIIADDR\_RGAD\_WIDTH 5
- #define ETH\_MIIADDR\_FIAD\_OFFSET 0
- #define ETH\_MIIADDR\_FIAD\_WIDTH 5
- #define ETH\_MIISTAT\_NVALID\_OFFSET 1
- #define ETH\_MIISTAT\_BUSY\_OFFSET 1
- #define ETH\_MIISTAT\_FAIL\_OFFSET 0
- #define ETH\_TX\_BD\_LENGTH\_OFFSET 16
- #define ETH\_TX\_BD\_LENGTH\_WIDTH 16
- #define ETH\_TX\_BD\_READY\_OFFSET 15
- #define ETH\_TX\_BD\_IRQ\_OFFSET 14
- #define ETH\_TX\_BD\_WRAP\_OFFSET 13
- #define ETH\_TX\_BD\_PAD\_OFFSET 12
- #define ETH\_TX\_BD\_CRC\_OFFSET 11
- #define ETH\_TX\_BD\_LAST\_OFFSET 10
- #define ETH\_TX\_BD\_PAUSE\_OFFSET 9
- #define ETH\_TX\_BD\_UNDERRUN\_OFFSET 8

- #define ETH\_TX\_BD\_RETRY\_OFFSET 4
- #define ETH\_TX\_BD\_RETRY\_WIDTH 4
- #define ETH\_TX\_BD\_RETRANSMIT\_OFFSET 3
- #define ETH\_TX\_BD\_COLLISION\_OFFSET 2
- #define ETH\_TX\_BD\_DEFER\_OFFSET 1
- #define ETH\_TX\_BD\_NO\_CARRIER\_OFFSET 0
- #define ETH\_RX\_BD\_LENGTH\_OFFSET 16
- #define ETH\_RX\_BD\_LENGTH\_WIDTH 16
- #define ETH\_RX\_BD\_READY\_OFFSET 15
- #define ETH\_RX\_BD\_IRQ\_OFFSET 14
- #define ETH\_RX\_BD\_WRAP\_OFFSET 13
- #define ETH\_RX\_BD\_MISS\_OFFSET 7
- #define ETH\_RX\_BD\_UVERRUN\_OFFSET 6
- #define ETH\_RX\_BD\_INVALID\_OFFSET 5
- #define ETH\_RX\_BD\_DRIBBLE\_OFFSET 4
- #define ETH\_RX\_BD\_TOOBIG\_OFFSET 3
- #define ETH\_RX\_BD\_TOOSHORT\_OFFSET 2
- #define ETH\_RX\_BD\_CRC\_OFFSET 1
- #define ETH\_RX\_BD\_COLLISION\_OFFSET 0
- #define ETH\_ALEN 6
- #define ETHERTYPE\_PUP 0x0200
- #define ETHERTYPE\_IP 0x0800
- #define ETHERTYPE\_ARP 0x0806
- #define ETHERTYPE\_REVARP 0x8035
- #define ETHER\_ADDR\_LEN ETH\_ALEN
- #define ETHER\_TYPE\_LEN 2
- #define ETHER\_CRC\_LEN 4
- #define ETHER\_HDR\_LEN ETH\_HLEN
- #define ETHER\_MIN\_LEN (ETH\_ZLEN + ETHER\_CRC\_LEN)
- #define ETHER\_MAX\_LEN (ETH\_FRAME\_LEN + ETHER\_CRC\_LEN)
- #define ETHER\_IS\_VALID\_LEN(foo) ((foo) >= ETHER\_MIN\_LEN && (foo) <= ETHER\_MAX\_LEN)
- #define ETHERTYPE\_TRAIL 0x1000
- #define ETHERTYPE\_NTRAILER 16
- #define ETHERMTU ETH\_DATA\_LEN
- #define ETHERMIN (ETHER\_MIN\_LEN-ETHER\_HDR\_LEN-ETHER\_CRC\_LEN)
- #define ETH\_TXSTATE\_IDLE 0
- #define ETH\_TXSTATE\_WAIT4BD 10
- #define ETH\_TXSTATE\_READFIFO 20
- #define ETH\_TXSTATE\_TRANSMIT 30
- #define ETH\_RXSTATE\_IDLE 0
- #define ETH\_RXSTATE\_WAIT4BD 10
- #define ETH\_RXSTATE\_RECV 20
- #define ETH\_RXSTATE\_WRITEFIFO 30
- #define ETH\_RTX\_FILE 0
- #define ETH\_RTX\_SOCKET 1
- #define ETH\_RTX\_VAPI 2
- #define ETH\_MAXPL 0x10000

## Enumerations

- enum { [ETH\\_VAPI\\_DATA](#) = 0, [ETH\\_VAPI\\_CTRL](#), [ETH\\_NUM\\_VAPI\\_IDS](#) }

## Functions

- static void [eth\\_vapi\\_read](#) (unsigned long id, unsigned long data, void \*dat)
- static void [eth\\_write32](#) ([oraddr\\_t](#) addr, [uint32\\_t](#) value, void \*dat)
- static [uint32\\_t](#) [eth\\_read32](#) ([oraddr\\_t](#) addr, void \*dat)
- static void [eth\\_controller\\_tx\\_clock](#) (void \*)
- static void [eth\\_controller\\_rx\\_clock](#) (void \*)
- static [ssize\\_t](#) [eth\\_read\\_rx\\_file](#) (struct [eth\\_device](#) \*, void \*, [size\\_t](#))
- static void [eth\\_skip\\_rx\\_file](#) (struct [eth\\_device](#) \*, [off\\_t](#))
- static void [eth\\_rx\\_next\\_packet](#) (struct [eth\\_device](#) \*)
- static void [eth\\_write\\_tx\\_bd\\_num](#) (struct [eth\\_device](#) \*, unsigned long value)
- static void [eth\\_reset](#) (void \*dat)
- static void [eth\\_status](#) (void \*dat)
- static void [eth\\_enabled](#) (union [param\\_val](#) val, void \*dat)
- static void [eth\\_baseaddr](#) (union [param\\_val](#) val, void \*dat)
- static void [eth\\_dma](#) (union [param\\_val](#) val, void \*dat)
- static void [eth\\_irq](#) (union [param\\_val](#) val, void \*dat)
- static void [eth\\_rtx\\_type](#) (union [param\\_val](#) val, void \*dat)
- static void [eth\\_rx\\_channel](#) (union [param\\_val](#) val, void \*dat)
- static void [eth\\_tx\\_channel](#) (union [param\\_val](#) val, void \*dat)
- static void [eth\\_rxfile](#) (union [param\\_val](#) val, void \*dat)
- static void [eth\\_txfile](#) (union [param\\_val](#) val, void \*dat)
- static void [eth\\_sockif](#) (union [param\\_val](#) val, void \*dat)
- static void [eth\\_vapi\\_id](#) (union [param\\_val](#) val, void \*dat)
- static void \* [eth\\_sec\\_start](#) (void)
- static void [eth\\_sec\\_end](#) (void \*dat)
- void [reg\\_ethernet\\_sec](#) ()





## 6.120.1 Define Documentation

- 6.120.1.1 `#define ETH_ADDR_SPACE 0x1000`
- 6.120.1.2 `#define ETH_ALEN 6`
- 6.120.1.3 `#define ETH_BD_BASE 0x400`
- 6.120.1.4 `#define ETH_BD_COUNT 0x100`
- 6.120.1.5 `#define ETH_BD_SPACE (4 * ETH_BD_COUNT)`
- 6.120.1.6 `#define ETH_CMODER_PASSALL_OFFSET 0`
- 6.120.1.7 `#define ETH_CMODER_RXFLOW_OFFSET 1`
- 6.120.1.8 `#define ETH_CMODER_TXFLOW_OFFSET 2`
- 6.120.1.9 `#define ETH_COLLCONF (4 * 0x07)`
- 6.120.1.10 `#define ETH_COLLCONF_COLLVALID_OFFSET 0`
- 6.120.1.11 `#define ETH_COLLCONF_COLLVALID_WIDTH 6`
- 6.120.1.12 `#define ETH_COLLCONF_MAXRET_OFFSET 16`
- 6.120.1.13 `#define ETH_COLLCONF_MAXRET_WIDTH 4`
- 6.120.1.14 `#define ETH_CTRLMODER (4 * 0x09)`
- 6.120.1.15 `#define ETH_DMA_RX_TX 0x800`
- 6.120.1.16 `#define ETH_HASH0 (4 * 0x12)`
- 6.120.1.17 `#define ETH_HASH1 (4 * 0x13)`
- 6.120.1.18 `#define ETH_INT_MASK (4 * 0x02)`
- 6.120.1.19 `#define ETH_INT_MASK_BUSY_M_OFFSET 4`
- 6.120.1.20 `#define ETH_INT_MASK_RXB_M_OFFSET 2`
- 6.120.1.21 `#define ETH_INT_MASK_RXC_M_OFFSET 6`
- 6.120.1.22 `#define ETH_INT_MASK_RXE_M_OFFSET 3`
- 6.120.1.23 `#define ETH_INT_MASK_TXB_M_OFFSET 0`
- 6.120.1.24 `#define ETH_INT_MASK_TXC_M_OFFSET 5`
- 6.120.1.25 `#define ETH_INT_MASK_TXE_M_OFFSET 1`
- 6.120.1.26 `#define ETH_INT_SOURCE (4 * 0x01)`
- 6.120.1.27 `#define ETH_INT_SOURCE_BUSY_OFFSET 4`
- 6.120.1.28 `#define ETH_INT_SOURCE_RXB_OFFSET 2`
- 6.120.1.29 `#define ETH_INT_SOURCE_RXC_OFFSET 6`
- 6.120.1.30 `#define ETH_INT_SOURCE_RXE_OFFSET 3`

**ETH\_VAPI\_CTRL**  
**ETH\_NUM\_VAPI\_IDS**

### 6.120.3 Function Documentation

#### 6.120.3.1 static void eth\_baseaddr (union param\_val val, void \* dat) [static]

Set the Ethernet interface base address

**Parameters:**

- ← *val* The value to use
- ← *dat* The config data structure

#### 6.120.3.2 static void eth\_controller\_rx\_clock (void \* dat) [static]

Here is the call graph for this function:

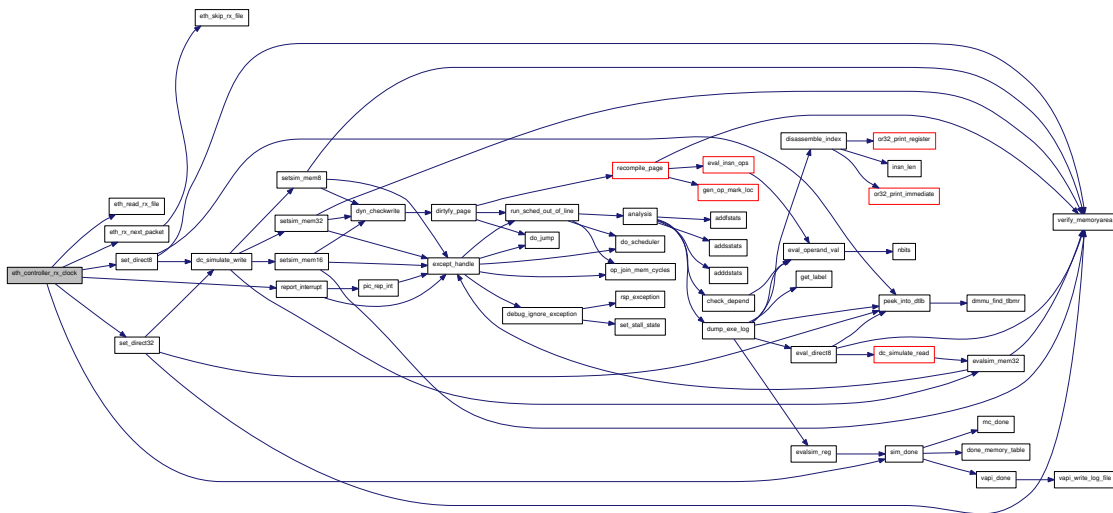

#### 6.120.3.3 static void eth\_controller\_tx\_clock (void \* dat) [static]

Here is the call graph for this function:

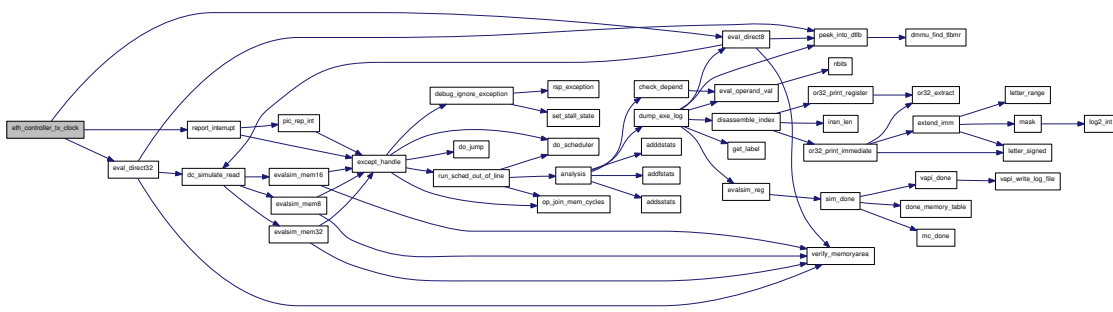

**6.120.3.4** `static void eth_dma (union param_val val, void * dat)` [static]

Set the Ethernet DMA port

This is not currently supported, so a warning message is printed.

**Parameters:**

- ← *val* The value to use
- ← *dat* The `config` data structure

**6.120.3.5** `static void eth_enabled (union param_val val, void * dat)` [static]

Enable or disable the Ethernet interface

**Parameters:**

- ← *val* The value to use
- ← *dat* The `config` data structure

**6.120.3.6** `static void eth_irq (union param_val val, void * dat)` [static]

Set the Ethernet IRQ

**Parameters:**

- ← *val* The value to use
- ← *dat* The `config` data structure

**6.120.3.7** `static uint32_t eth_read32 (oraddr_t addr, void * dat)` [static]**6.120.3.8** `static ssize_t eth_read_rx_file (struct eth_device * eth, void * buf, size_t count)` [static]**6.120.3.9** `static void eth_reset (void * dat)` [static]

Here is the call graph for this function:

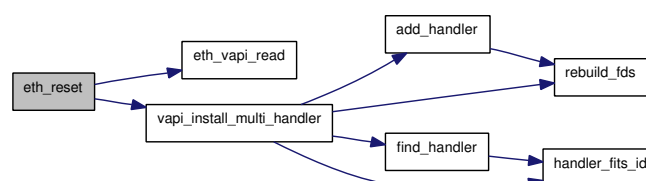

**6.120.3.10** `static void eth_rtx_type (union param_val val, void * dat)` [static]

Set the Ethernet interface type

Currently two types are supported, file and socket. Use of the socket requires a compile time option.

**Parameters:**

← *val* The value to use. 0 for file, 1 for socket.

← *dat* The `config` data structure

**6.120.3.11** `static void eth_rx_channel (union param_val val, void * dat)` [static]

Set the Ethernet DMA Rx `channel`

External DMA is not currently supported, so a warning message is printed.

**Parameters:**

← *val* The value to use

← *dat* The `config` data structure

**6.120.3.12** `static void eth_rx_next_packet (struct eth_device * eth)` [static]

Here is the call graph for this function:

**6.120.3.13** `static void eth_rxfile (union param_val val, void * dat)` [static]

Set the Ethernet DMA Rx file

Free any previously allocated value.

**Parameters:**

← *val* The value to use

← *dat* The `config` data structure



### 6.120.3.14 static void eth\_sec\_end (void \* dat) [static]

Here is the call graph for this function:

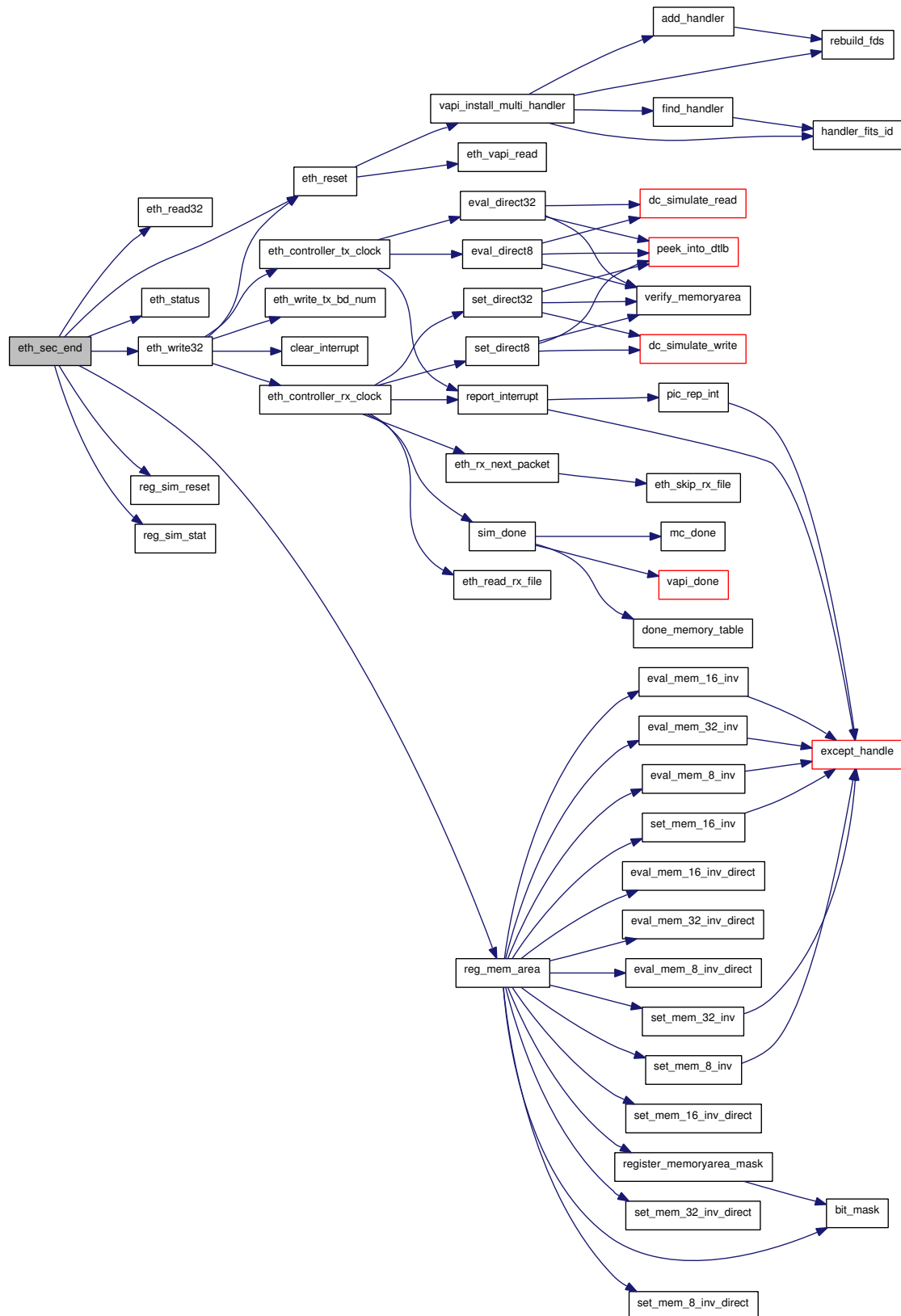

**6.120.3.15** `static void* eth_sec_start (void)` [static]

Initialize a new Ethernet configuration

ALL parameters are set explicitly to default values.

**6.120.3.16** `static void eth_skip_rx_file (struct eth_device *eth, off_t count)` [static]**6.120.3.17** `static void eth_sockif (union param_val val, void *dat)` [static]

Set the Ethernet socket interface

Free any previously allocated value. This is only meaningful if the socket interface is configured.

**Parameters:**

← *val* The value to use

← *dat* The `config` data structure

**6.120.3.18** `static void eth_status (void *dat)` [static]**6.120.3.19** `static void eth_tx_channel (union param_val val, void *dat)` [static]

Set the Ethernet DMA Tx `channel`

External DMA is not currently supported, so a warning message is printed.

**Parameters:**

← *val* The value to use

← *dat* The `config` data structure

**6.120.3.20** `static void eth_txfile (union param_val val, void *dat)` [static]

Set the Ethernet DMA Tx file

Free any previously allocated value.

**Parameters:**

← *val* The value to use

← *dat* The `config` data structure

**6.120.3.21** `static void eth_vapi_id (union param_val val, void * dat)` [static]

**6.120.3.22** `static void eth_vapi_read (unsigned long id, unsigned long data, void * dat)`  
[static]

**6.120.3.23** `static void eth_write32 (oraddr_t addr, uint32_t value, void * dat)` [static]

Here is the call graph for this function:

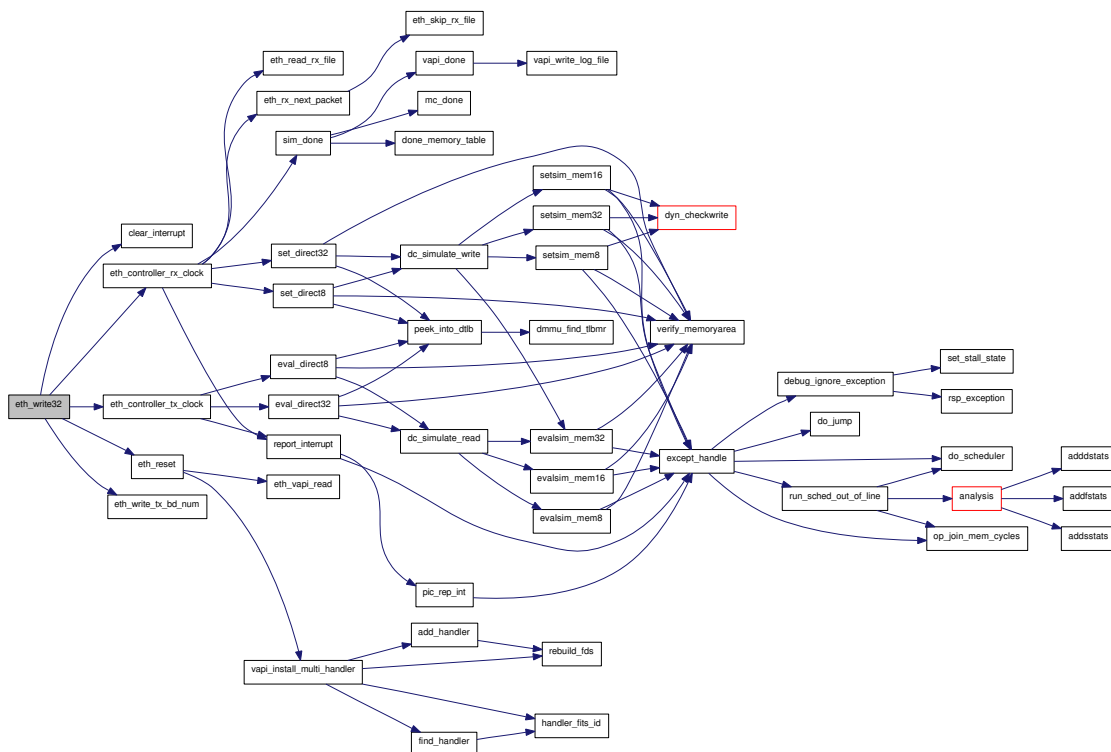

**6.120.3.24** `static void eth_write_tx_bd_num (struct eth_device * eth, unsigned long value)`  
[static]

**6.120.3.25** `void reg_ethernet_sec ()`

Register a new Ethernet configuration



Here is the call graph for this function:

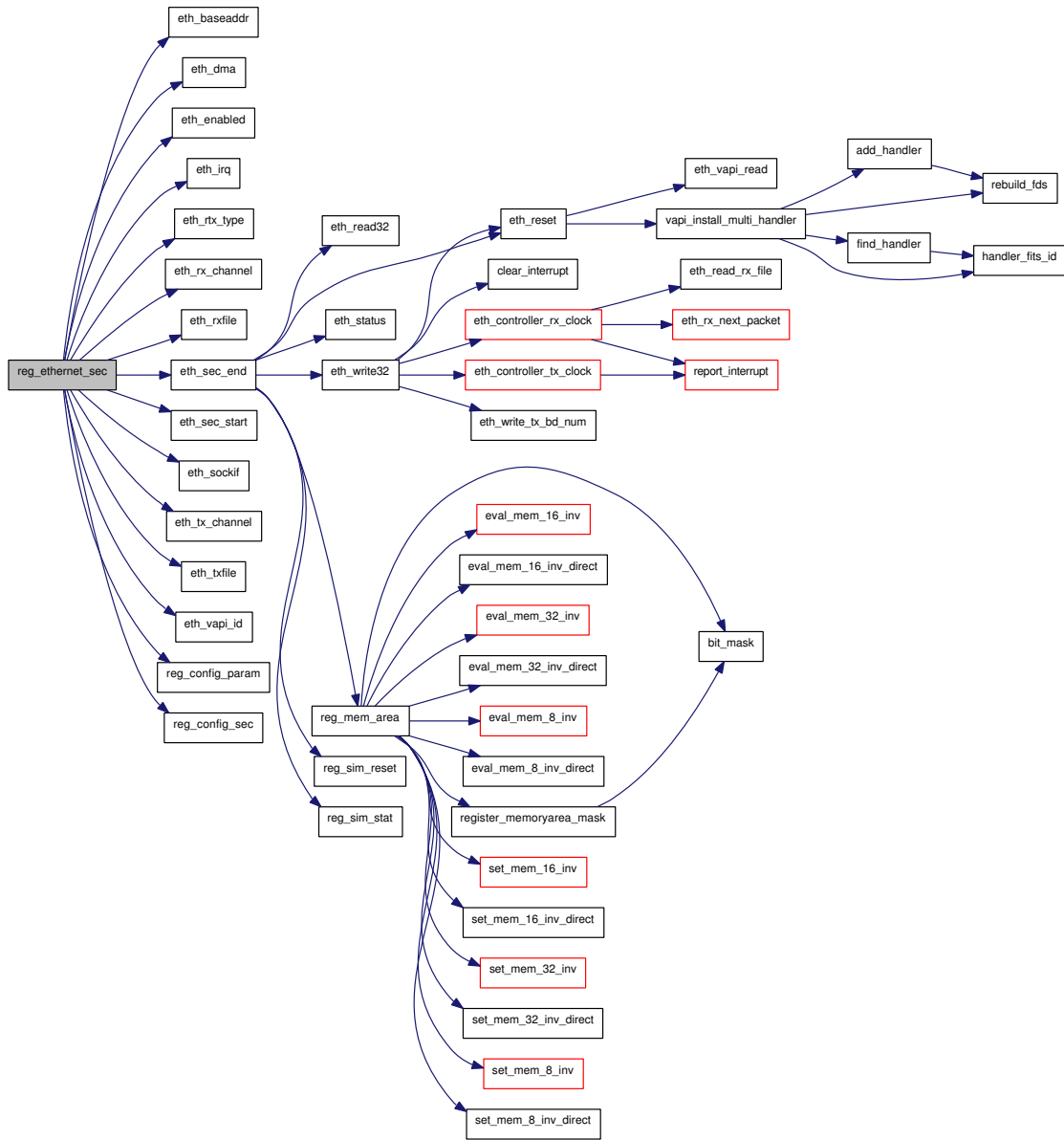

## 6.121 peripheral/eth.h File Reference

This graph shows which files directly or indirectly include this file:

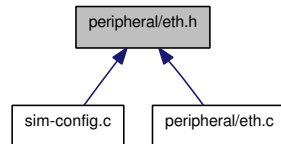

### Functions

- void [reg\\_ethernet\\_sec](#) ()

#### 6.121.1 Function Documentation

##### 6.121.1.1 void [reg\\_ethernet\\_sec](#) ()

Register a new Ethernet configuration

Here is the call graph for this function:

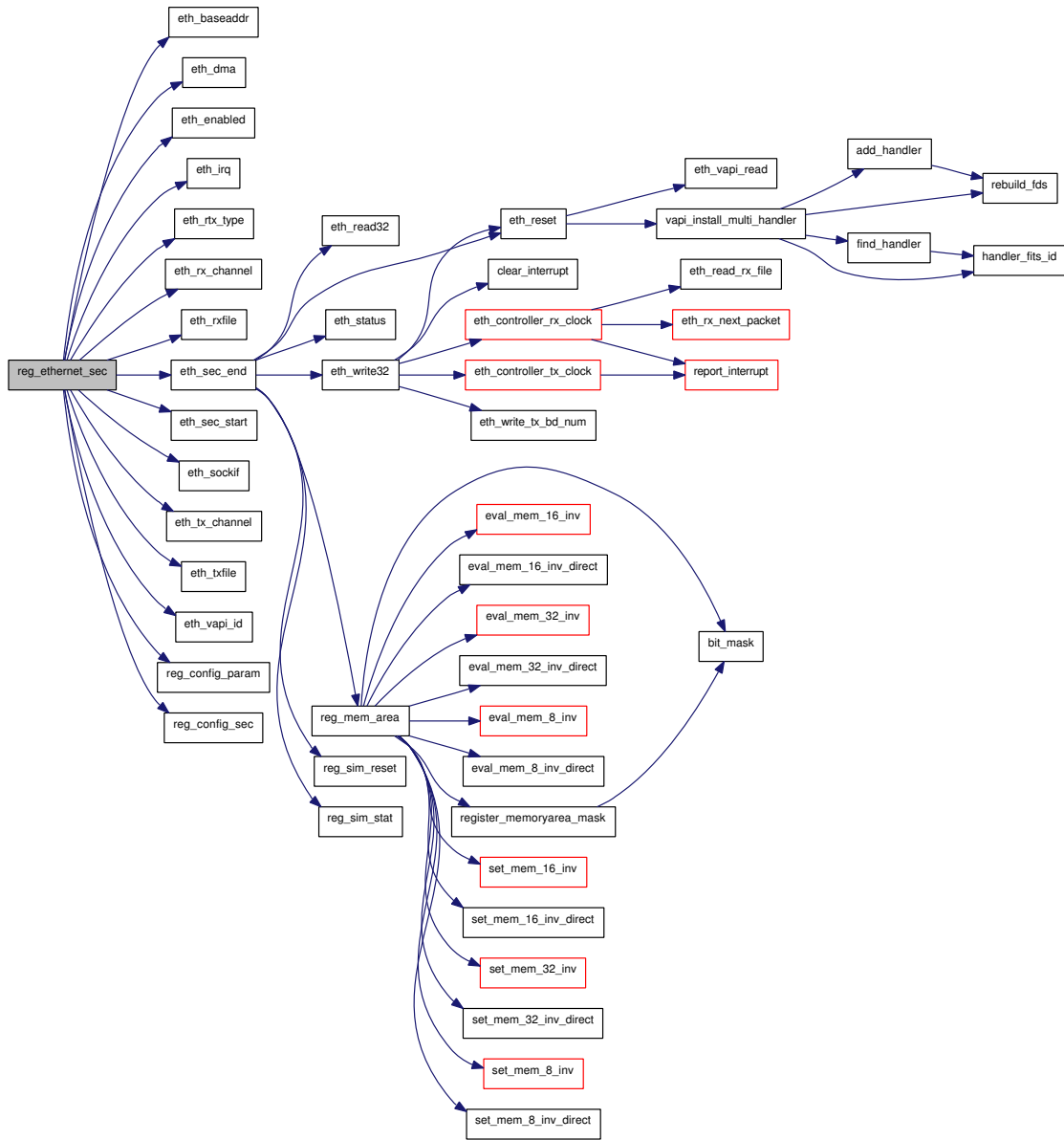

## 6.122 peripheral/fb.c File Reference

```
#include "config.h"
#include "port.h"
#include <stdlib.h>
#include <stdio.h>
#include "arch.h"
#include "sim-config.h"
#include "abstract.h"
#include "sched.h"
#include "toplevel-support.h"
```

Include dependency graph for fb.c:

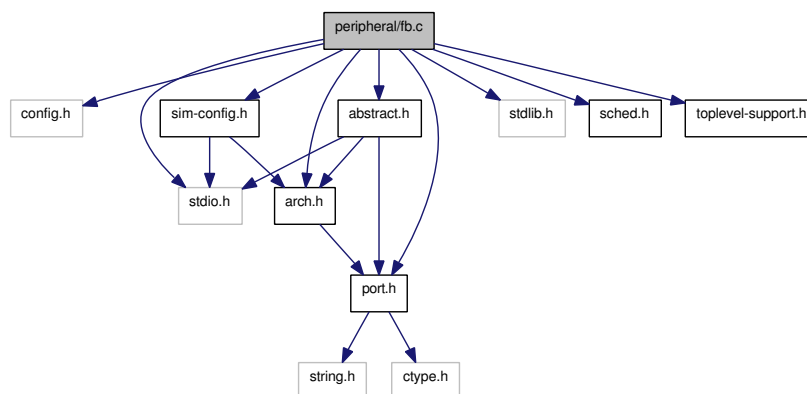

### Data Structures

- struct [fb\\_state](#)

### Defines

- #define [FB\\_SIZEX](#) 640
- #define [FB\\_SIZEY](#) 480
- #define [CAM\\_SIZEX](#) 352
- #define [CAM\\_SIZEY](#) 288
- #define [REFRESH\\_DIVIDER](#) 20
- #define [FB\\_CTRL](#) 0x0000
- #define [FB\\_BUFADDR](#) 0x0004
- #define [FB\\_CAMBUFADDR](#) 0x0008
- #define [FB\\_CAMPOSADDR](#) 0x000c
- #define [FB\\_PAL](#) 0x0400
- #define [FB\\_WRAP](#) (512\*1024)
- #define [CNV16\(x\)](#) (x)
- #define [CNV32\(x\)](#) (x)

## Functions

- static void `change_buf_addr` (struct `fb_state` \*fb, `oraddr_t` addr)
- static void `fb_write32` (`oraddr_t` addr, `uint32_t` value, void \*dat)
- static `oraddr_t` `fb_read32` (`oraddr_t` addr, void \*dat)
- static int `fb_dump_image8` (struct `fb_state` \*fb, char \*filename)
- static int `fb_dump_image24` (struct `fb_state` \*fb, char \*filename)
- static void `fb_job` (void \*dat)
- static void `fb_reset` (void \*dat)
- static void `fb_enabled` (union `param_val` val, void \*dat)
- static void `fb_baseaddr` (union `param_val` val, void \*dat)
- static void `fb_refresh_rate` (union `param_val` val, void \*dat)
- static void `fb_filename` (union `param_val` val, void \*dat)
- static void \* `fb_sec_start` ()
- static void `fb_sec_end` (void \*dat)
- void `reg_fb_sec` ()

### 6.122.1 Define Documentation

6.122.1.1 `#define CAM_SIZEX 352`

6.122.1.2 `#define CAM_SIZEY 288`

6.122.1.3 `#define CNV16(x) (x)`

6.122.1.4 `#define CNV32(x) (x)`

6.122.1.5 `#define FB_BUFADDR 0x0004`

6.122.1.6 `#define FB_CAMBUFADDR 0x0008`

6.122.1.7 `#define FB_CAMPOSADDR 0x000c`

6.122.1.8 `#define FB_CTRL 0x0000`

6.122.1.9 `#define FB_PAL 0x0400`

6.122.1.10 `#define FB_SIZEX 640`

6.122.1.11 `#define FB_SIZEY 480`

6.122.1.12 `#define FB_WRAP (512*1024)`

6.122.1.13 `#define REFRESH_DIVIDER 20`

Relative amount of time spent in refresh









6.122.2.14 void reg\_fb\_sec ()

Here is the call graph for this function:

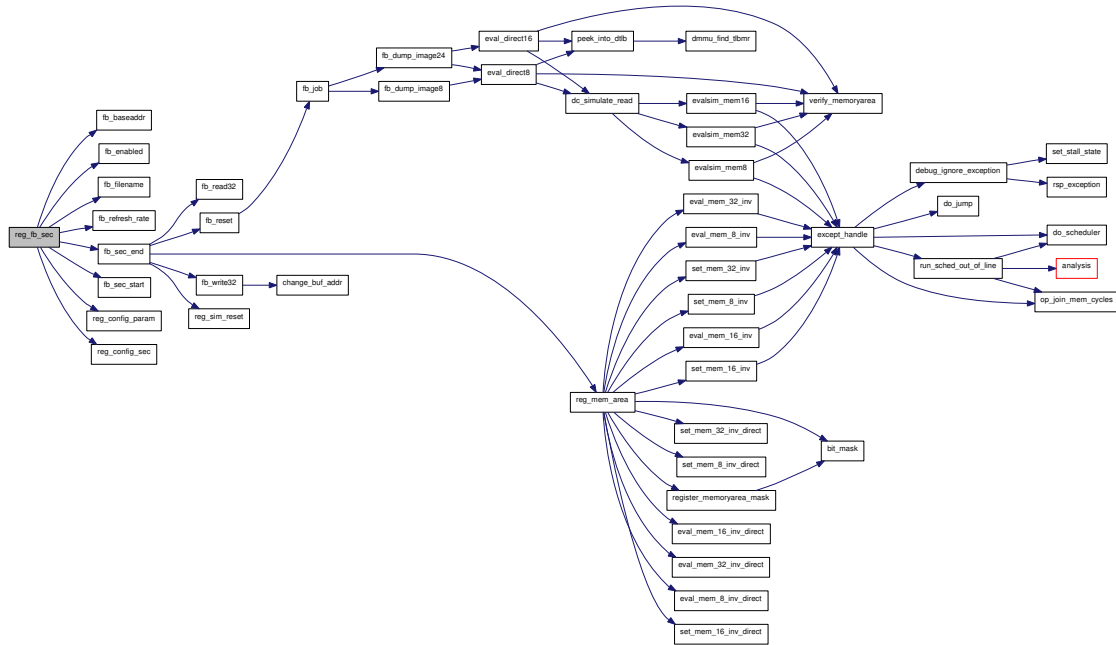

## 6.123 peripheral/fb.h File Reference

This graph shows which files directly or indirectly include this file:

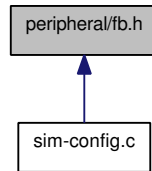

### Functions

- void [reg\\_fb\\_sec \(\)](#)

### 6.123.1 Function Documentation

#### 6.123.1.1 void reg\_fb\_sec ()

Here is the call graph for this function:

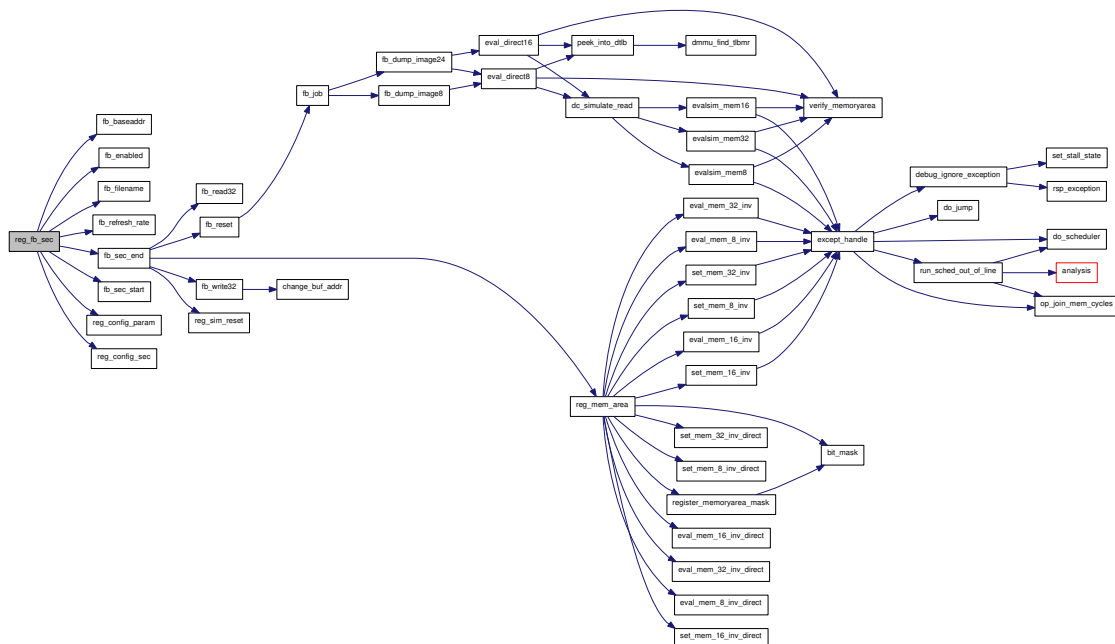

## 6.124 peripheral/fields.h File Reference

This graph shows which files directly or indirectly include this file:

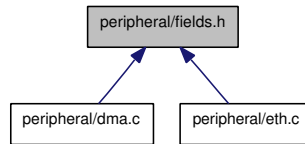

### Defines

- #define **FLAG\_SHIFT**(reg\_name, flag\_name) (reg\_name##\_##flag\_name##\_OFFSET)
- #define **FLAG\_MASK**(reg\_name, flag\_name) (1LU << reg\_name##\_##flag\_name##\_OFFSET)
- #define **TEST\_FLAG**(reg\_value, reg\_name, flag\_name) (((reg\_value) >> reg\_name##\_##flag\_name##\_OFFSET) & 1LU)
- #define **SET\_FLAG**(reg\_value, reg\_name, flag\_name) { (reg\_value) |= 1LU << reg\_name##\_##flag\_name##\_OFFSET; }
- #define **CLEAR\_FLAG**(reg\_value, reg\_name, flag\_name) { (reg\_value) &= ~(1LU << reg\_name##\_##flag\_name##\_OFFSET); }
- #define **ASSIGN\_FLAG**(reg\_value, reg\_name, flag\_name, flag\_value)
- #define **FIELD\_SHIFT**(reg\_name, field\_name) (reg\_name##\_##field\_name##\_OFFSET)
- #define **FIELD\_MASK**(reg\_name, field\_name) ((~(~0LU << reg\_name##\_##field\_name##\_WIDTH)) << reg\_name##\_##field\_name##\_OFFSET)
- #define **GET\_FIELD**(reg\_value, reg\_name, field\_name) (((reg\_value) >> reg\_name##\_##field\_name##\_OFFSET) & (~(~0LU << reg\_name##\_##field\_name##\_WIDTH)))
- #define **SET\_FIELD**(reg\_value, reg\_name, field\_name, field\_value)

### 6.124.1 Define Documentation

#### 6.124.1.1 #define ASSIGN\_FLAG(reg\_value, reg\_name, flag\_name, flag\_value)

**Value:**

```
{ \
    (reg_value) = flag_value ? ((reg_value) | (1LU << reg_name##_##flag_name##_OFFSET)) : ((reg_value) & ~
```

6.124.1.2 **#define CLEAR\_FLAG(reg\_value, reg\_name, flag\_name) { (reg\_value) &= ~(1LU << reg\_name##\_##flag\_name##\_OFFSET); }**

6.124.1.3 **#define FIELD\_MASK(reg\_name, field\_name) ((~(~0LU << reg\_name##\_##field\_name##\_WIDTH)) << reg\_name##\_##field\_name##\_OFFSET)**

6.124.1.4 **#define FIELD\_SHIFT(reg\_name, field\_name) (reg\_name##\_##field\_name##\_OFFSET)**

6.124.1.5 **#define FLAG\_MASK(reg\_name, flag\_name) (1LU << reg\_name##\_##flag\_name##\_OFFSET)**

6.124.1.6 **#define FLAG\_SHIFT(reg\_name, flag\_name) (reg\_name##\_##flag\_name##\_OFFSET)**

6.124.1.7 **#define GET\_FIELD(reg\_value, reg\_name, field\_name) (((reg\_value) >> reg\_name##\_##field\_name##\_OFFSET) & (~(~0LU << reg\_name##\_##field\_name##\_WIDTH)))**

6.124.1.8 **#define SET\_FIELD(reg\_value, reg\_name, field\_name, field\_value)**

**Value:**

```
{ \
    (reg_value) = ((reg_value) & ~((~(~0LU << reg_name##_##field_name##_WIDTH)) << reg_name##_##field_name##_OFFSET)) | ((field_value) << reg_name##_##field_name##_OFFSET); }
```

6.124.1.9 **#define SET\_FLAG(reg\_value, reg\_name, flag\_name) { (reg\_value) |= 1LU << reg\_name##\_##flag\_name##\_OFFSET; }**

6.124.1.10 **#define TEST\_FLAG(reg\_value, reg\_name, flag\_name) (((reg\_value) >> reg\_name##\_##flag\_name##\_OFFSET) & 1LU)**

## 6.125 peripheral/generic.c File Reference

```
#include "config.h"
#include <stdlib.h>
#include <stdio.h>
#include "arch.h"
#include "sim-config.h"
#include "abstract.h"
#include "toplevel-support.h"
#include "sim-cmd.h"
```

Include dependency graph for generic.c:

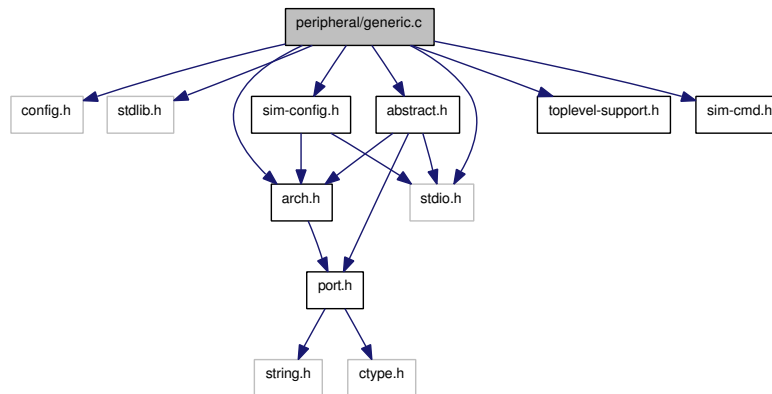

### Data Structures

- struct [dev\\_generic](#)

### Functions

- static unsigned long int [htoml](#) (unsigned long int host\_val)
- static unsigned short int [htoms](#) (unsigned short int host\_val)
- static unsigned long int [mtohl](#) (unsigned long int model\_val)
- static unsigned short int [mtohs](#) (unsigned short int model\_val)
- static unsigned long int [ext\\_read](#) (unsigned long int addr, unsigned long int mask)
- static void [ext\\_write](#) (unsigned long int addr, unsigned long int mask, unsigned long int value)
- static uint8\_t [generic\\_read\\_byte](#) (oraddr\_t addr, void \*dat)
- static void [generic\\_write\\_byte](#) (oraddr\_t addr, uint8\_t value, void \*dat)
- static uint16\_t [generic\\_read\\_hw](#) (oraddr\_t addr, void \*dat)
- static void [generic\\_write\\_hw](#) (oraddr\_t addr, uint16\_t value, void \*dat)
- static uint32\_t [generic\\_read\\_word](#) (oraddr\_t addr, void \*dat)
- static void [generic\\_write\\_word](#) (oraddr\_t addr, uint32\_t value, void \*dat)
- static void [generic\\_reset](#) (void \*dat)
- static void [generic\\_status](#) (void \*dat)

- static void `generic_enabled` (union `param_val` val, void \*dat)
- static void `generic_byte_enabled` (union `param_val` val, void \*dat)
- static void `generic_hw_enabled` (union `param_val` val, void \*dat)
- static void `generic_word_enabled` (union `param_val` val, void \*dat)
- static void `generic_name` (union `param_val` val, void \*dat)
- static void `generic_baseaddr` (union `param_val` val, void \*dat)
- static void `generic_size` (union `param_val` val, void \*dat)
- static void \* `generic_sec_start` ()
- static void `generic_sec_end` (void \*dat)
- void `reg_generic_sec` (void)

## 6.125.1 Function Documentation

**6.125.1.1** static unsigned long int `ext_read` (unsigned long int *addr*, unsigned long int *mask*)  
[static]

**6.125.1.2** static void `ext_write` (unsigned long int *addr*, unsigned long int *mask*, unsigned long int *value*) [static]

**6.125.1.3** static void `generic_baseaddr` (union `param_val` *val*, void \* *dat*) [static]

**6.125.1.4** static void `generic_byte_enabled` (union `param_val` *val*, void \* *dat*) [static]

**6.125.1.5** static void `generic_enabled` (union `param_val` *val*, void \* *dat*) [static]

**6.125.1.6** static void `generic_hw_enabled` (union `param_val` *val*, void \* *dat*) [static]

**6.125.1.7** static void `generic_name` (union `param_val` *val*, void \* *dat*) [static]

**6.125.1.8** static uint8\_t `generic_read_byte` (oraddr\_t *addr*, void \* *dat*) [static]

Here is the call graph for this function:

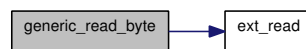

**6.125.1.9** static uint16\_t `generic_read_hw` (oraddr\_t *addr*, void \* *dat*) [static]

Here is the call graph for this function:

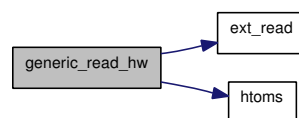

### 6.125.1.10 static uint32\_t generic\_read\_word (oraddr\_t addr, void \* dat) [static]

Here is the call graph for this function:

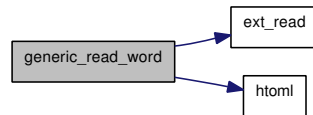

### 6.125.1.11 static void generic\_reset (void \* dat) [static]

### 6.125.1.12 static void generic\_sec\_end (void \* dat) [static]

Here is the call graph for this function:

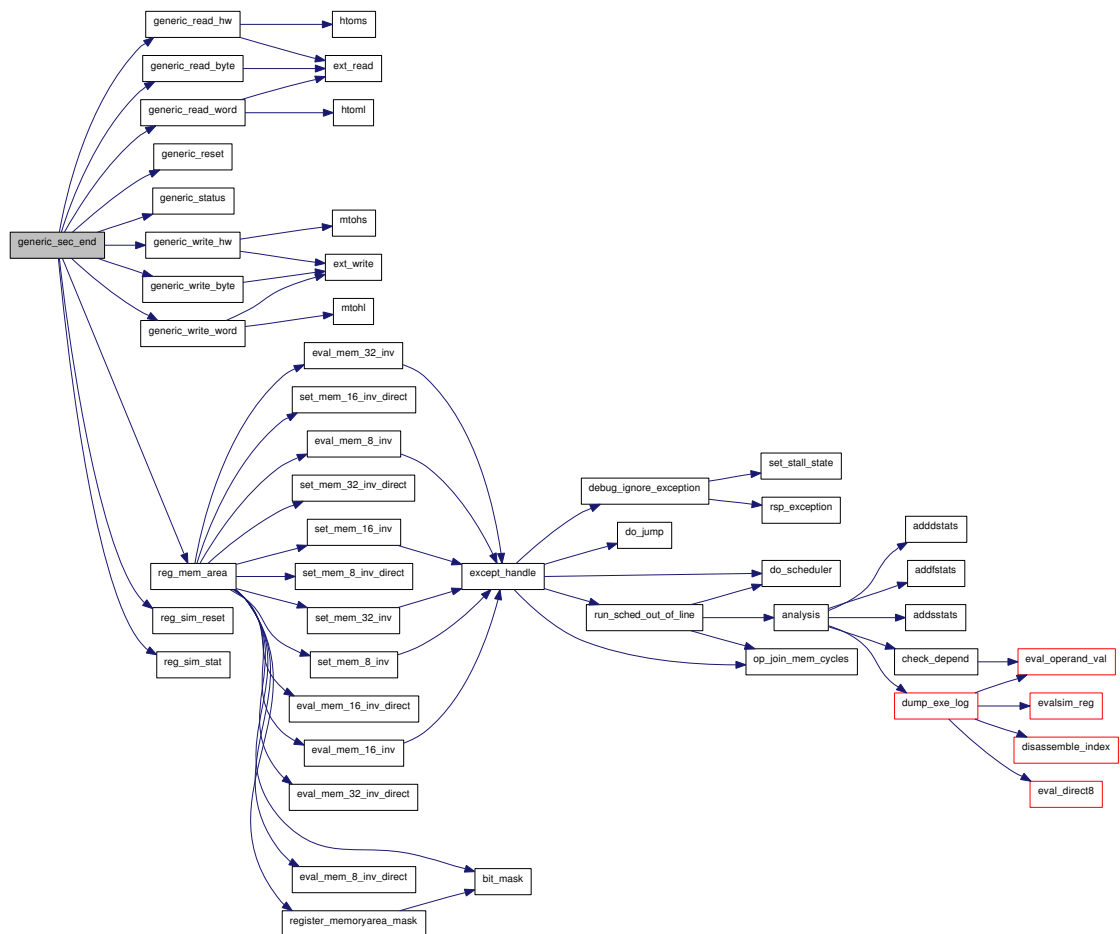

**6.125.1.13** `static void* generic_sec_start ()` [static]

**6.125.1.14** `static void generic_size (union param_val val, void * dat)` [static]

**6.125.1.15** `static void generic_status (void * dat)` [static]

**6.125.1.16** `static void generic_word_enabled (union param_val val, void * dat)` [static]

**6.125.1.17** `static void generic_write_byte (oraddr_t addr, uint8_t value, void * dat)` [static]

Here is the call graph for this function:

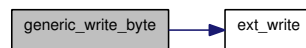

**6.125.1.18** `static void generic_write_hw (oraddr_t addr, uint16_t value, void * dat)` [static]

Here is the call graph for this function:

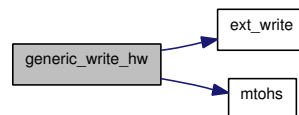

**6.125.1.19** `static void generic_write_word (oraddr_t addr, uint32_t value, void * dat)` [static]

Here is the call graph for this function:

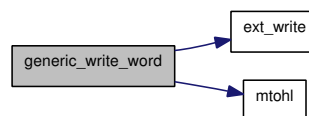



6.125.1.20 static unsigned long int htoml (unsigned long int *host\_val*) [static]

6.125.1.21 static unsigned short int htoms (unsigned short int *host\_val*) [static]

6.125.1.22 static unsigned long int mtohl (unsigned long int *model\_val*) [static]

6.125.1.23 static unsigned short int mtohs (unsigned short int *model\_val*) [static]

6.125.1.24 void reg\_generic\_sec (void)

Here is the call graph for this function:

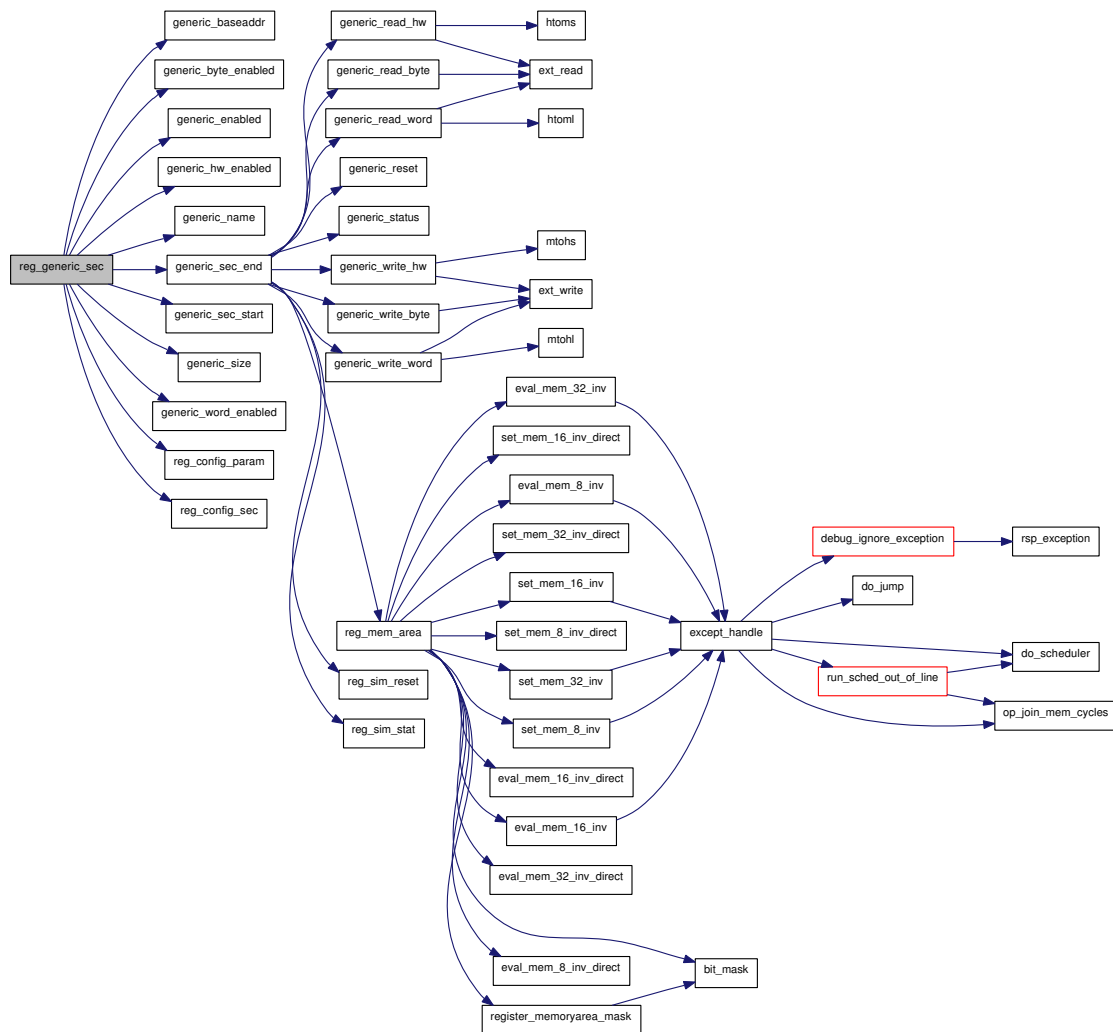

## 6.126 peripheral/channels/generic.c File Reference

```
#include "config.h"  
#include <stdlib.h>  
#include <errno.h>
```

Include dependency graph for generic.c:

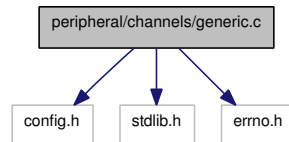

### Functions

- int [generic\\_open](#) (void \*data)
- void [generic\\_close](#) (void \*data)
- void [generic\\_free](#) (void \*data)

#### 6.126.1 Function Documentation

6.126.1.1 void [generic\\_close](#) (void \* *data*)

6.126.1.2 void [generic\\_free](#) (void \* *data*)

6.126.1.3 int [generic\\_open](#) (void \* *data*)

## 6.127 peripheral/generic.h File Reference

### Functions

- void [reg\\_generic\\_sec](#) ()

#### 6.127.1 Function Documentation

##### 6.127.1.1 void [reg\\_generic\\_sec](#) ()

Here is the call graph for this function:

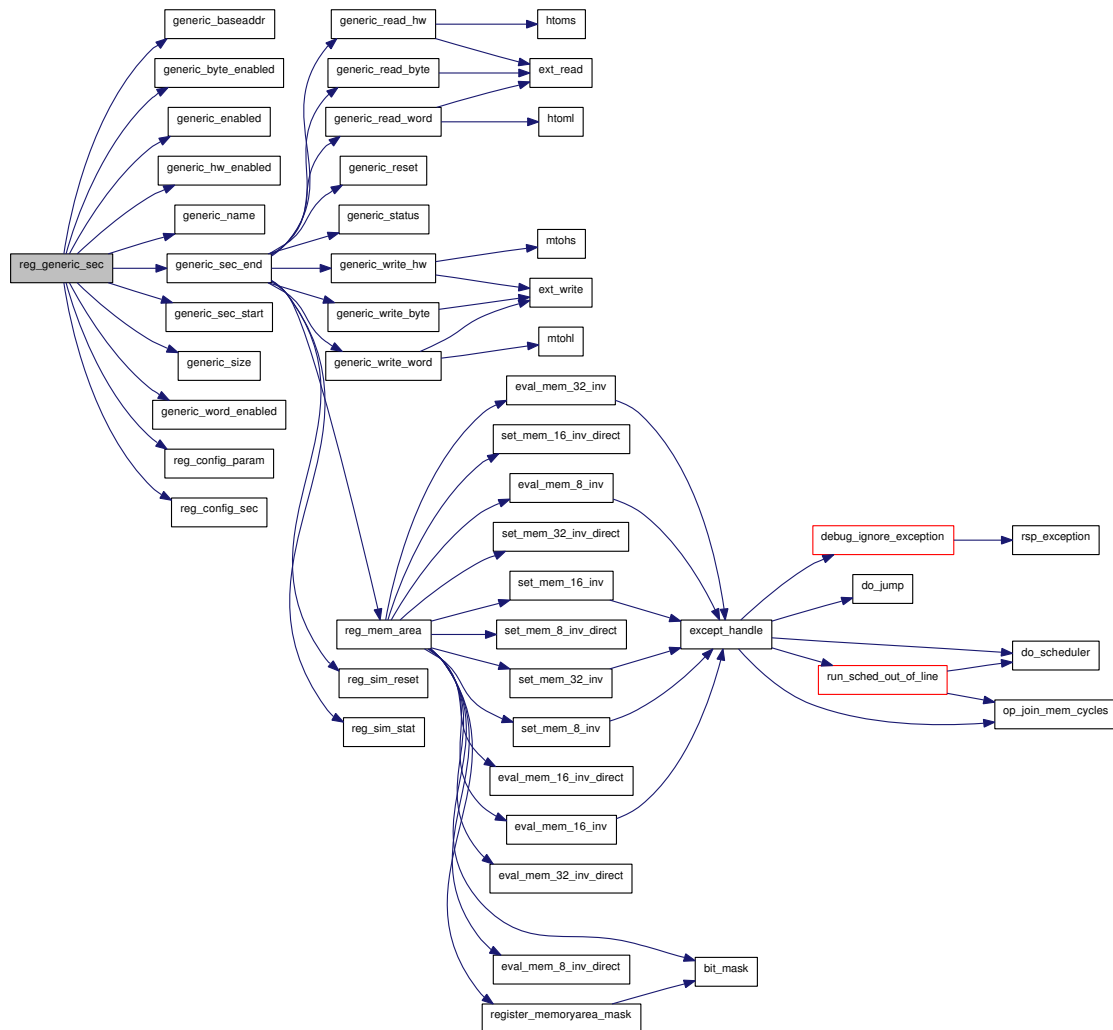

## 6.128 peripheral/channels/generic.h File Reference

This graph shows which files directly or indirectly include this file:

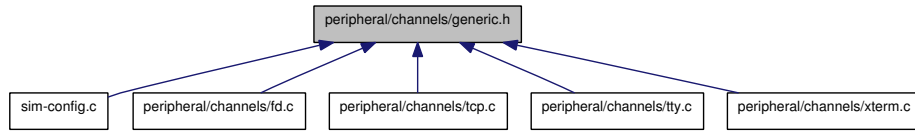

### Functions

- int [generic\\_open](#) (void \*data)
- void [generic\\_close](#) (void \*data)
- void [generic\\_free](#) (void \*data)

#### 6.128.1 Function Documentation

**6.128.1.1** void [generic\\_close](#) (void \* *data*)

**6.128.1.2** void [generic\\_free](#) (void \* *data*)

**6.128.1.3** int [generic\\_open](#) (void \* *data*)

## 6.129 peripheral/gpio.c File Reference

```
#include "config.h"
#include "port.h"
#include <stdlib.h>
#include "sim-config.h"
#include "arch.h"
#include "vapi.h"
#include "sched.h"
#include "pic.h"
#include "abstract.h"
#include "toplevel-support.h"
#include "sim-cmd.h"
```

Include dependency graph for gpio.c:

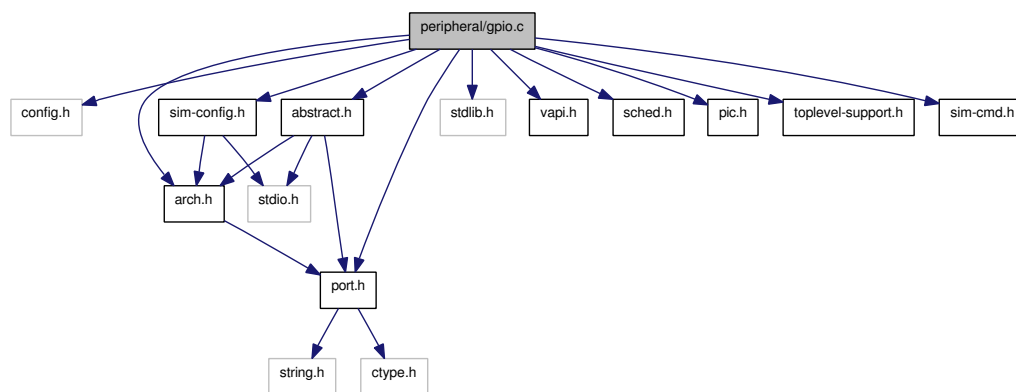

### Data Structures

- struct [gpio\\_device](#)

### Defines

- #define [GPIO\\_ADDR\\_SPACE](#) 0x20
- #define [RGPIO\\_IN](#) 0x00
- #define [RGPIO\\_OUT](#) 0x04
- #define [RGPIO\\_OE](#) 0x08
- #define [RGPIO\\_INTE](#) 0x0C
- #define [RGPIO\\_PTRIG](#) 0x10
- #define [RGPIO\\_AUX](#) 0x14
- #define [RGPIO\\_CTRL](#) 0x18
- #define [RGPIO\\_INTS](#) 0x1C
- #define [RGPIO\\_CTRL\\_ECLK](#) 0x00000001
- #define [RGPIO\\_CTRL\\_NEC](#) 0x00000002

- #define `RGPIO_CTRL_INTE` 0x00000004
- #define `RGPIO_CTRL_INTS` 0x00000008

## Enumerations

- enum {  
  
    `GPIO_VAPI_DATA` = 0, `GPIO_VAPI_AUX`, `GPIO_VAPI_CLOCK`, `GPIO_VAPI_RGPIO_OE`,  
  
    `GPIO_VAPI_RGPIO_INTE`, `GPIO_VAPI_RGPIO_PTRIG`, `GPIO_VAPI_RGPIO_AUX`, `GPIO_VAPI_RGPIO_CTRL`,  
  
    `GPIO_NUM_VAPI_IDS` }

## Functions

- static void `gpio_vapi_read` (unsigned long id, unsigned long data, void \*dat)
- static void `gpio_external_clock` (unsigned long value, struct `gpio_device` \*gpio)
- static void `gpio_device_clock` (struct `gpio_device` \*gpio)
- static void `gpio_clock` (void \*dat)
- static void `gpio_reset` (void \*dat)
- static void `gpio_status` (void \*dat)
- static uint32\_t `gpio_read32` (oraddr\_t addr, void \*dat)
- static void `gpio_write32` (oraddr\_t addr, uint32\_t value, void \*dat)
- static void `gpio_do_int` (void \*dat)
- static void `gpio_baseaddr` (union `param_val` val, void \*dat)
- static void `gpio_irq` (union `param_val` val, void \*dat)
- static void `gpio_base_vapi_id` (union `param_val` val, void \*dat)
- static void `gpio_enabled` (union `param_val` val, void \*dat)
- static void \* `gpio_sec_start` (void)
- static void `gpio_sec_end` (void \*dat)
- void `reg_gpio_sec` (void)

## 6.129.1 Define Documentation

- 6.129.1.1 `#define GPIO_ADDR_SPACE 0x20`
- 6.129.1.2 `#define RGPIO_AUX 0x14`
- 6.129.1.3 `#define RGPIO_CTRL 0x18`
- 6.129.1.4 `#define RGPIO_CTRL_ECLK 0x00000001`
- 6.129.1.5 `#define RGPIO_CTRL_INTE 0x00000004`
- 6.129.1.6 `#define RGPIO_CTRL_INTS 0x00000008`
- 6.129.1.7 `#define RGPIO_CTRL_NEC 0x00000002`
- 6.129.1.8 `#define RGPIO_IN 0x00`
- 6.129.1.9 `#define RGPIO_INTE 0x0C`
- 6.129.1.10 `#define RGPIO_INTS 0x1C`
- 6.129.1.11 `#define RGPIO_OE 0x08`
- 6.129.1.12 `#define RGPIO_OUT 0x04`
- 6.129.1.13 `#define RGPIO_PTRIG 0x10`

## 6.129.2 Enumeration Type Documentation

### 6.129.2.1 anonymous enum

Enumerator:

*GPIO\_VAPI\_DATA*

*GPIO\_VAPI\_AUX*

*GPIO\_VAPI\_CLOCK*

*GPIO\_VAPI\_RGPIO\_OE*

*GPIO\_VAPI\_RGPIO\_INTE*

*GPIO\_VAPI\_RGPIO\_PTRIG*

*GPIO\_VAPI\_RGPIO\_AUX*

*GPIO\_VAPI\_RGPIO\_CTRL*

*GPIO\_NUM\_VAPI\_IDS*

## 6.129.3 Function Documentation

**6.129.3.1** `static void gpio_base_vapi_id (union param_val val, void * dat)` [static]

**6.129.3.2** `static void gpio_baseaddr (union param_val val, void * dat)` [static]

**6.129.3.3** `static void gpio_clock (void * dat)` [static]

Here is the call graph for this function:

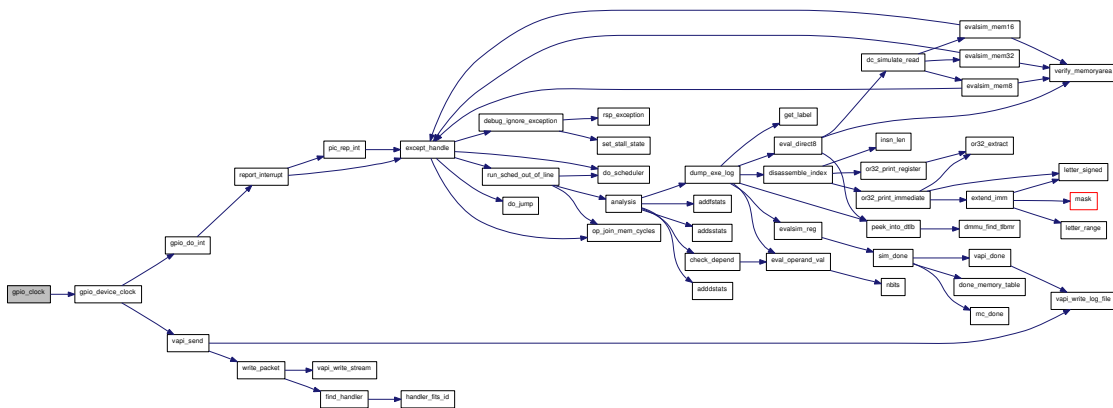

**6.129.3.4** `static void gpio_device_clock (struct gpio_device * gpio)` [static]

Here is the call graph for this function:

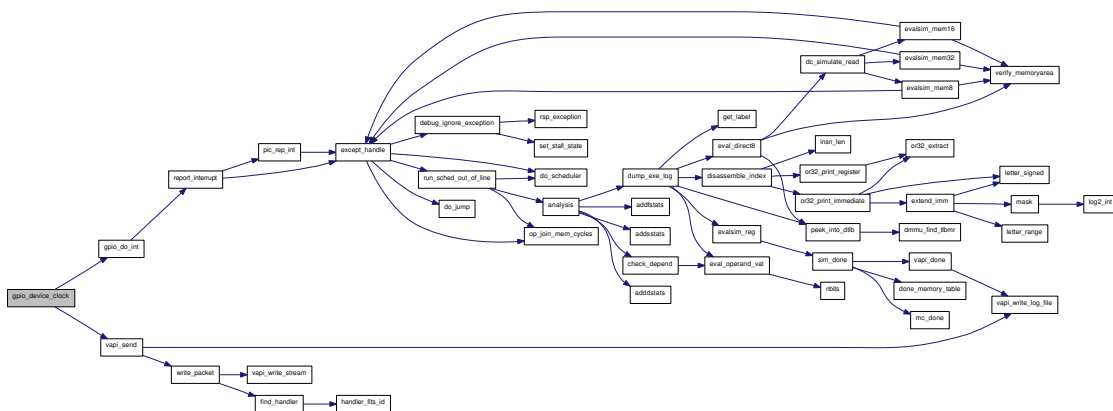







6.129.3.12 `static void* gpio_sec_start (void)` [static]

6.129.3.13 `static void gpio_status (void * dat)` [static]

6.129.3.14 `static void gpio_vapi_read (unsigned long id, unsigned long data, void * dat)` [static]

Here is the call graph for this function:

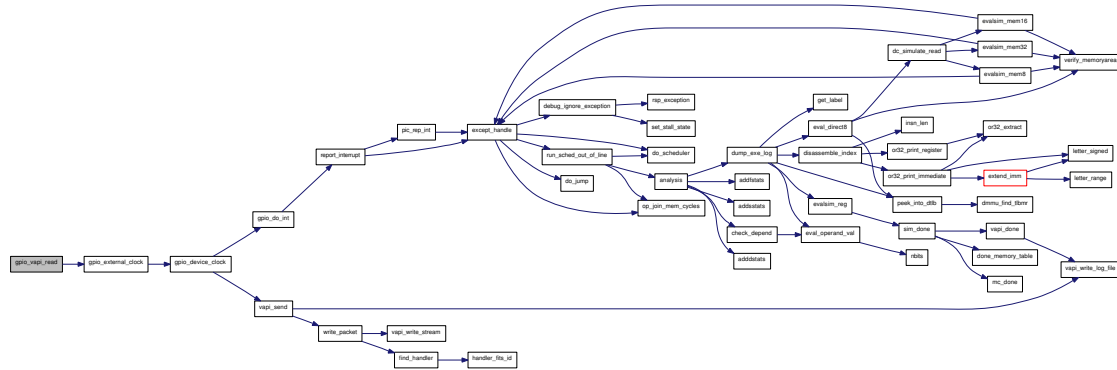

6.129.3.15 `static void gpio_write32 (oraddr_t addr, uint32_t value, void * dat)` [static]

Here is the call graph for this function:



6.129.3.16 `void reg_gpio_sec (void)`

Here is the call graph for this function:

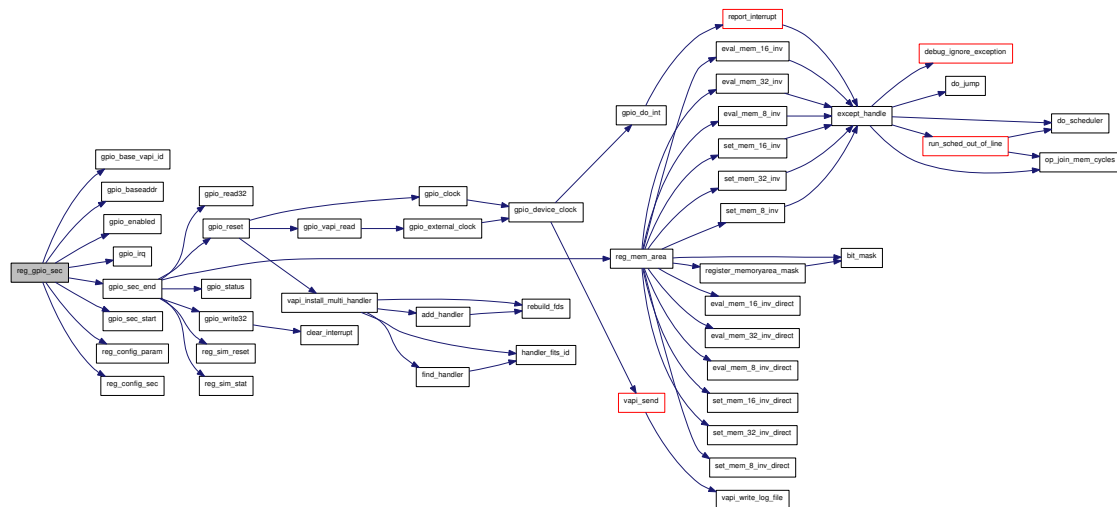

## 6.130 peripheral/gpio.h File Reference

This graph shows which files directly or indirectly include this file:

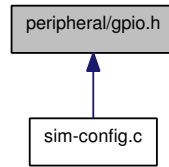

### Functions

- void [reg\\_gpio\\_sec \(\)](#)

#### 6.130.1 Function Documentation

##### 6.130.1.1 void [reg\\_gpio\\_sec \(\)](#)

Here is the call graph for this function:

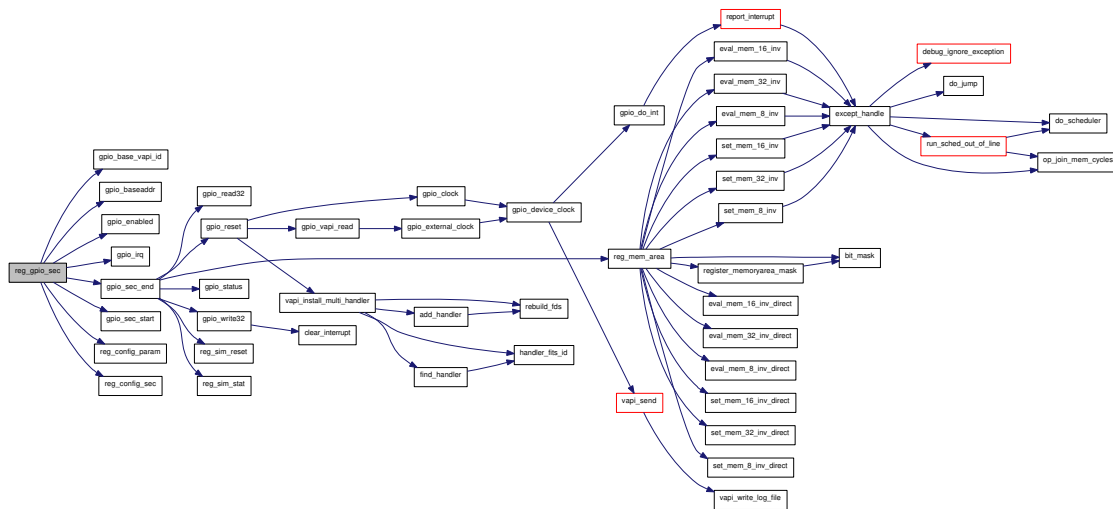

## 6.131 peripheral/mc.c File Reference

```
#include "config.h"
#include "port.h"
#include <stdlib.h>
#include "arch.h"
#include "abstract.h"
#include "sim-config.h"
#include "toplevel-support.h"
#include "sim-cmd.h"
```

Include dependency graph for mc.c:

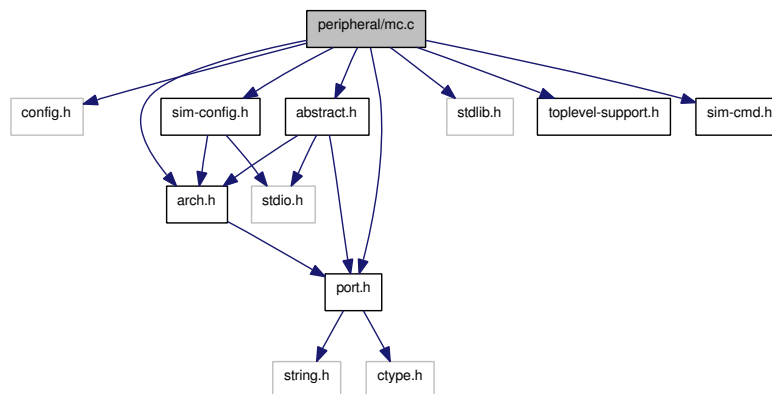

### Data Structures

- struct [mc\\_area](#)
- struct [mc](#)

### Defines

- #define [N\\_CE](#) 8
- #define [MC\\_CSR](#) 0x00
- #define [MC\\_POC](#) 0x04
- #define [MC\\_BA\\_MASK](#) 0x08
- #define [MC\\_CSC](#)(i) (0x10 + (i) \* 8)
- #define [MC\\_TMS](#)(i) (0x14 + (i) \* 8)
- #define [MC\\_ADDR\\_SPACE](#) (MC\_CSC(N\_CE))
- #define [MC\\_POC\\_EN\\_BW\\_OFFSET](#) 0
- #define [MC\\_POC\\_EN\\_BW\\_WIDTH](#) 2
- #define [MC\\_POC\\_EN\\_MEMTYPE\\_OFFSET](#) 2
- #define [MC\\_POC\\_EN\\_MEMTYPE\\_WIDTH](#) 2
- #define [MC\\_CSC\\_EN\\_OFFSET](#) 0
- #define [MC\\_CSC\\_MEMTYPE\\_OFFSET](#) 1

- #define MC\_CSC\_MEMTYPE\_WIDTH 2
- #define MC\_CSC\_BW\_OFFSET 4
- #define MC\_CSC\_BW\_WIDTH 2
- #define MC\_CSC\_MS\_OFFSET 6
- #define MC\_CSC\_MS\_WIDTH 2
- #define MC\_CSC\_WP\_OFFSET 8
- #define MC\_CSC\_BAS\_OFFSET 9
- #define MC\_CSC\_KRO\_OFFSET 10
- #define MC\_CSC\_PEN\_OFFSET 11
- #define MC\_CSC\_SEL\_OFFSET 16
- #define MC\_CSC\_SEL\_WIDTH 8
- #define MC\_CSC\_MEMTYPE\_SDRAM 0
- #define MC\_CSC\_MEMTYPE\_SSRAM 1
- #define MC\_CSC\_MEMTYPE\_ASYNC 2
- #define MC\_CSC\_MEMTYPE\_SYNC 3
- #define MC\_CSR\_VALID 0xFF000703LU
- #define MC\_POC\_VALID 0x0000000FLU
- #define MC\_BA\_MASK\_VALID 0x000003FFLU
- #define MC\_CSC\_VALID 0x00FF0FFFU
- #define MC\_TMS\_SDRAM\_VALID 0x0FFF83FFLU
- #define MC\_TMS\_SSRAM\_VALID 0x00000000LU
- #define MC\_TMS\_ASYNC\_VALID 0x03FFFFFFLU
- #define MC\_TMS\_SYNC\_VALID 0x01FFFFFFLU
- #define MC\_TMS\_VALID 0xFFFFFFFU
- #define MC\_TMS\_SDRAM\_TRFC\_OFFSET 24
- #define MC\_TMS\_SDRAM\_TRFC\_WIDTH 4
- #define MC\_TMS\_SDRAM\_TRP\_OFFSET 20
- #define MC\_TMS\_SDRAM\_TRP\_WIDTH 4
- #define MC\_TMS\_SDRAM\_TRCD\_OFFSET 17
- #define MC\_TMS\_SDRAM\_TRCD\_WIDTH 4
- #define MC\_TMS\_SDRAM\_TWR\_OFFSET 15
- #define MC\_TMS\_SDRAM\_TWR\_WIDTH 2
- #define MC\_TMS\_SDRAM\_WBL\_OFFSET 9
- #define MC\_TMS\_SDRAM\_OM\_OFFSET 7
- #define MC\_TMS\_SDRAM\_OM\_WIDTH 2
- #define MC\_TMS\_SDRAM\_CL\_OFFSET 4
- #define MC\_TMS\_SDRAM\_CL\_WIDTH 3
- #define MC\_TMS\_SDRAM\_BT\_OFFSET 3
- #define MC\_TMS\_SDRAM\_BL\_OFFSET 0
- #define MC\_TMS\_SDRAM\_BL\_WIDTH 3
- #define MC\_TMS\_ASYNC\_TWWD\_OFFSET 20
- #define MC\_TMS\_ASYNC\_TWWD\_WIDTH 6
- #define MC\_TMS\_ASYNC\_TWD\_OFFSET 16
- #define MC\_TMS\_ASYNC\_TWD\_WIDTH 4
- #define MC\_TMS\_ASYNC\_TWPW\_OFFSET 12
- #define MC\_TMS\_ASYNC\_TWPW\_WIDTH 4
- #define MC\_TMS\_ASYNC\_TRDZ\_OFFSET 8
- #define MC\_TMS\_ASYNC\_TRDZ\_WIDTH 4
- #define MC\_TMS\_ASYNC\_TRDV\_OFFSET 0
- #define MC\_TMS\_ASYNC\_TRDV\_WIDTH 8

- #define `MC_TMS_SYNC_TTO_OFFSET` 16
- #define `MC_TMS_SYNC_TTO_WIDTH` 9
- #define `MC_TMS_SYNC_TWR_OFFSET` 12
- #define `MC_TMS_SYNC_TWR_WIDTH` 4
- #define `MC_TMS_SYNC_TRDZ_OFFSET` 8
- #define `MC_TMS_SYNC_TRDZ_WIDTH` 4
- #define `MC_TMS_SYNC_TRDV_OFFSET` 0
- #define `MC_TMS_SYNC_TRDV_WIDTH` 8

## Functions

- void `set_csc_tms` (int cs, uint32\_t csc, uint32\_t tms, struct `mc` \*mc)
- void `mc_write_word` (oraddr\_t addr, uint32\_t value, void \*dat)
- uint32\_t `mc_read_word` (oraddr\_t addr, void \*dat)
- void `mc_reset` (void \*dat)
- void `mc_done` ()
- void `mc_status` (void \*dat)
- void `mc_reg_mem_area` (struct `dev_memarea` \*mem, unsigned int cs, int mc)
- static void `mc_enabled` (union `param_val` val, void \*dat)
- static void `mc_baseaddr` (union `param_val` val, void \*dat)
- static void `mc_poc` (union `param_val` val, void \*dat)
- static void `mc_index` (union `param_val` val, void \*dat)
- static void \* `mc_sec_start` ()
- static void `mc_sec_end` (void \*dat)
- void `reg_mc_sec` (void)

## Variables

- static struct `mc` \* `mcs` = NULL
- static struct `mc_area` \* `mc_areas` = NULL





### 6.131.1 Define Documentation

6.131.1.1 `#define MC_ADDR_SPACE (MC_CSC(N_CE))`

6.131.1.2 `#define MC_BA_MASK 0x08`

6.131.1.3 `#define MC_BA_MASK_VALID 0x000003FFLU`

6.131.1.4 `#define MC_CSC(i) (0x10 + (i) * 8)`

6.131.1.5 `#define MC_CSC_BAS_OFFSET 9`

6.131.1.6 `#define MC_CSC_BW_OFFSET 4`

6.131.1.7 `#define MC_CSC_BW_WIDTH 2`

6.131.1.8 `#define MC_CSC_EN_OFFSET 0`

6.131.1.9 `#define MC_CSC_KRO_OFFSET 10`

6.131.1.10 `#define MC_CSC_MEMTYPE_ASYNC 2`

6.131.1.11 `#define MC_CSC_MEMTYPE_OFFSET 1`

6.131.1.12 `#define MC_CSC_MEMTYPE_SDRAM 0`

6.131.1.13 `#define MC_CSC_MEMTYPE_SSRAM 1`

6.131.1.14 `#define MC_CSC_MEMTYPE_SYNC 3`

6.131.1.15 `#define MC_CSC_MEMTYPE_WIDTH 2`

6.131.1.16 `#define MC_CSC_MS_OFFSET 6`

6.131.1.17 `#define MC_CSC_MS_WIDTH 2`

6.131.1.18 `#define MC_CSC_PEN_OFFSET 11`

6.131.1.19 `#define MC_CSC_SEL_OFFSET 16`

6.131.1.20 `#define MC_CSC_SEL_WIDTH 8`

6.131.1.21 `#define MC_CSC_VALID 0x00FF0FFFLLU`

6.131.1.22 `#define MC_CSC_WP_OFFSET 8`

6.131.1.23 `#define MC_CSR 0x00`

6.131.1.24 `#define MC_CSR_VALID 0xFF000703LU`

6.131.1.25 `#define MC_POC 0x04`

6.131.1.26 `#define MC_POC_EN_BW_OFFSET 0`

6.131.1.27 `#define MC_POC_EN_BW_WIDTH 2`

6.131.1.28 `#define MC_POC_EN_MEMTYPE_OFFSET 2`

6.131.1.29 `#define MC_POC_EN_MEMTYPE_WIDTH 2`

6.131.1.30 `#define MC_POC_VALID 0x0000000FLU`

**6.131.2.3** `static void mc_enabled (union param_val val, void * dat) [static]`

**6.131.2.4** `static void mc_index (union param_val val, void * dat) [static]`

**6.131.2.5** `static void mc_poc (union param_val val, void * dat) [static]`

Set the power on configuration state

Only the bottom 4 bits are significant. Other bits are truncated with a warning.

**Parameters:**

← *val* The value to use

← *dat* The [config](#) data structure

**6.131.2.6** `uint32_t mc_read_word (oraddr_t addr, void * dat)`

**6.131.2.7** `void mc_reg_mem_area (struct dev_memarea * mem, unsigned int cs, int mc)`

**6.131.2.8** `void mc_reset (void * dat)`

Here is the call graph for this function:

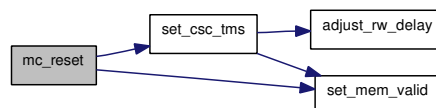

### 6.131.2.9 static void mc\_sec\_end (void \* dat) [static]

Here is the call graph for this function:

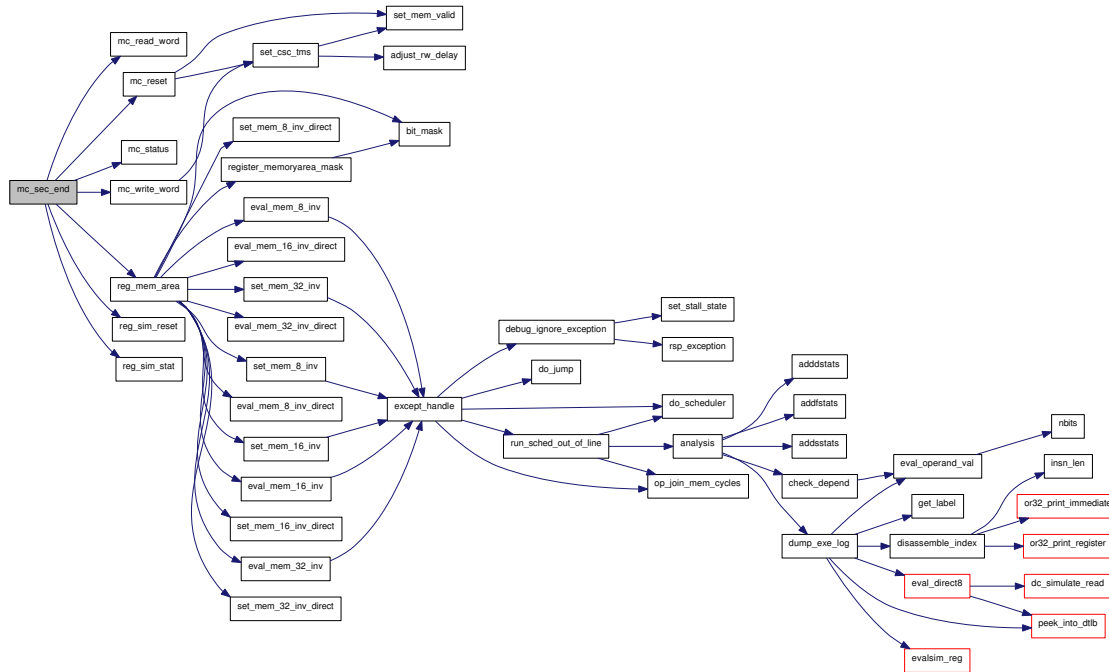

### 6.131.2.10 static void\* mc\_sec\_start () [static]

Initialize a new memory controller configuration

ALL parameters are set explicitly to default values.

### 6.131.2.11 void mc\_status (void \* dat)

### 6.131.2.12 void mc\_write\_word (oraddr\_t addr, uint32\_t value, void \* dat)

Here is the call graph for this function:

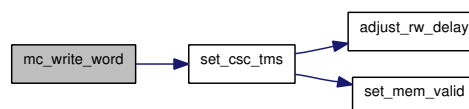

### 6.131.2.13 void reg\_mc\_sec (void)

Here is the call graph for this function:

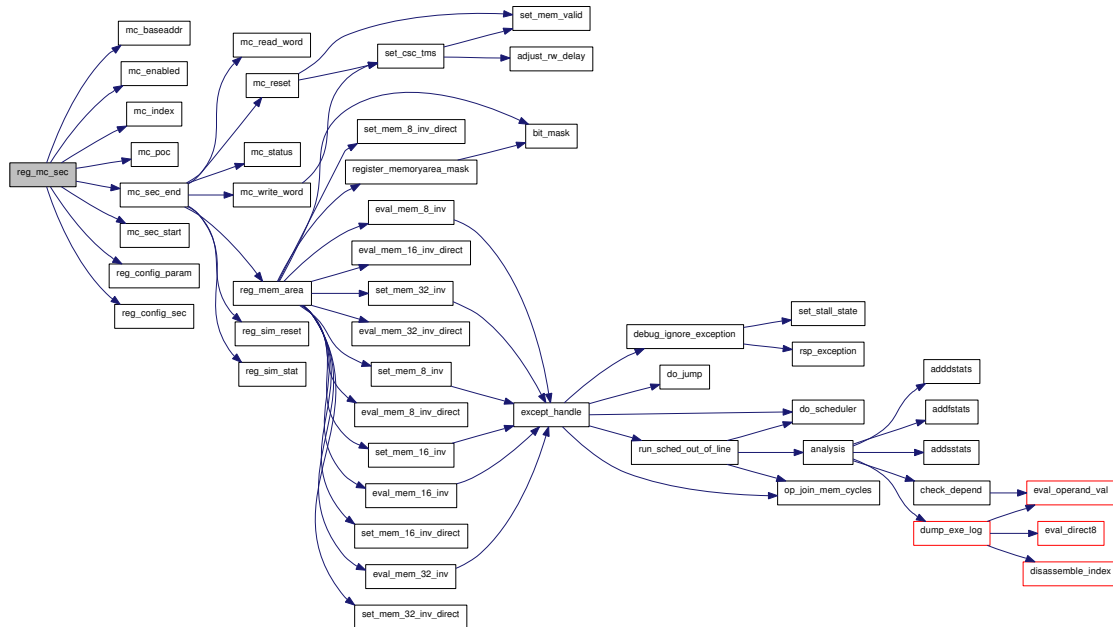

### 6.131.2.14 void set\_csc\_tms (int cs, uint32\_t csc, uint32\_t tms, struct mc \* mc)

Here is the call graph for this function:

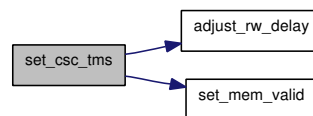

## 6.131.3 Variable Documentation

6.131.3.1 struct mc\_area\* mc\_areas = NULL [static]

6.131.3.2 struct mc\* mcs = NULL [static]

## 6.132 peripheral/mc.h File Reference

```
#include "abstract.h"
```

Include dependency graph for mc.h:

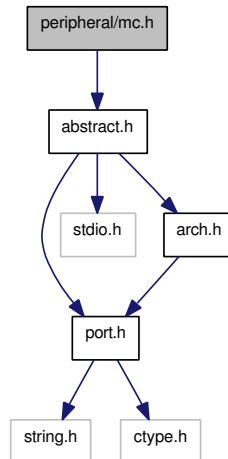

This graph shows which files directly or indirectly include this file:

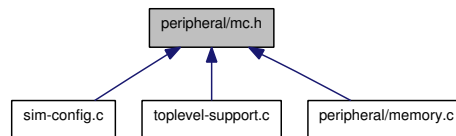

### Functions

- void `mc_done` ()
- void `reg_mc_sec` ()
- void `mc_reg_mem_area` (struct `dev_memarea` \*mem, unsigned int cs, int mc)

### 6.132.1 Function Documentation

#### 6.132.1.1 void mc\_done ()

Free all allocated memory

6.132.1.2 void mc\_reg\_mem\_area (struct dev\_memarea \* mem, unsigned int cs, int mc)

6.132.1.3 void reg\_mc\_sec ()

Here is the call graph for this function:

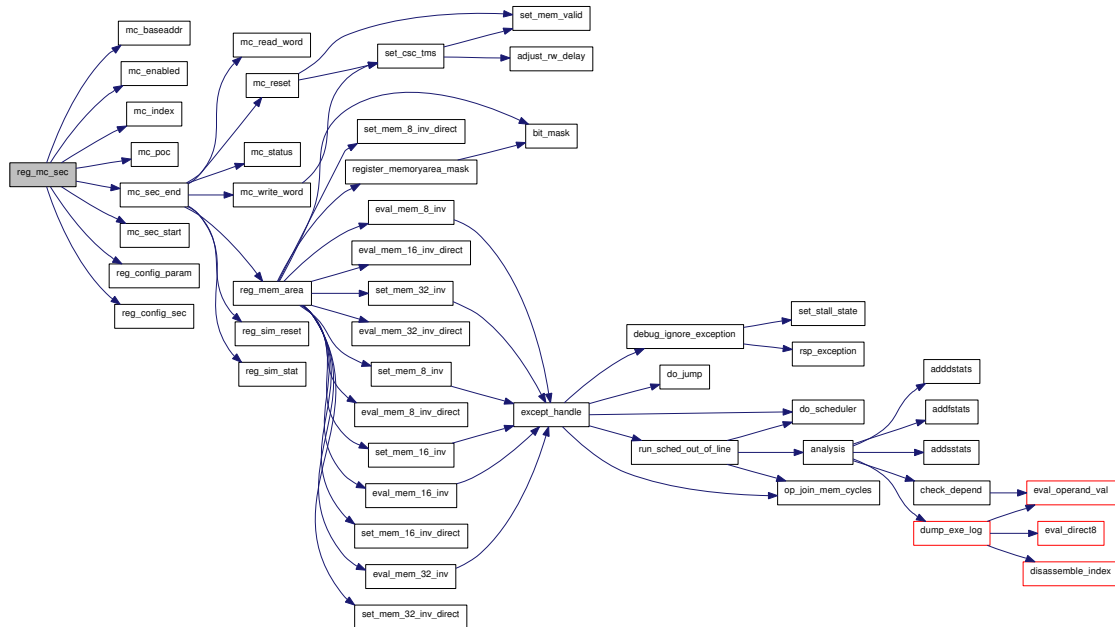

## 6.133 peripheral/memory.h File Reference

This graph shows which files directly or indirectly include this file:

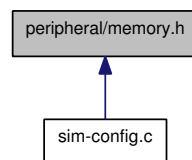

### Functions

- void [reg\\_memory\\_sec](#) ()

## 6.133.1 Function Documentation

### 6.133.1.1 void reg\_memory\_sec ()

Here is the call graph for this function:

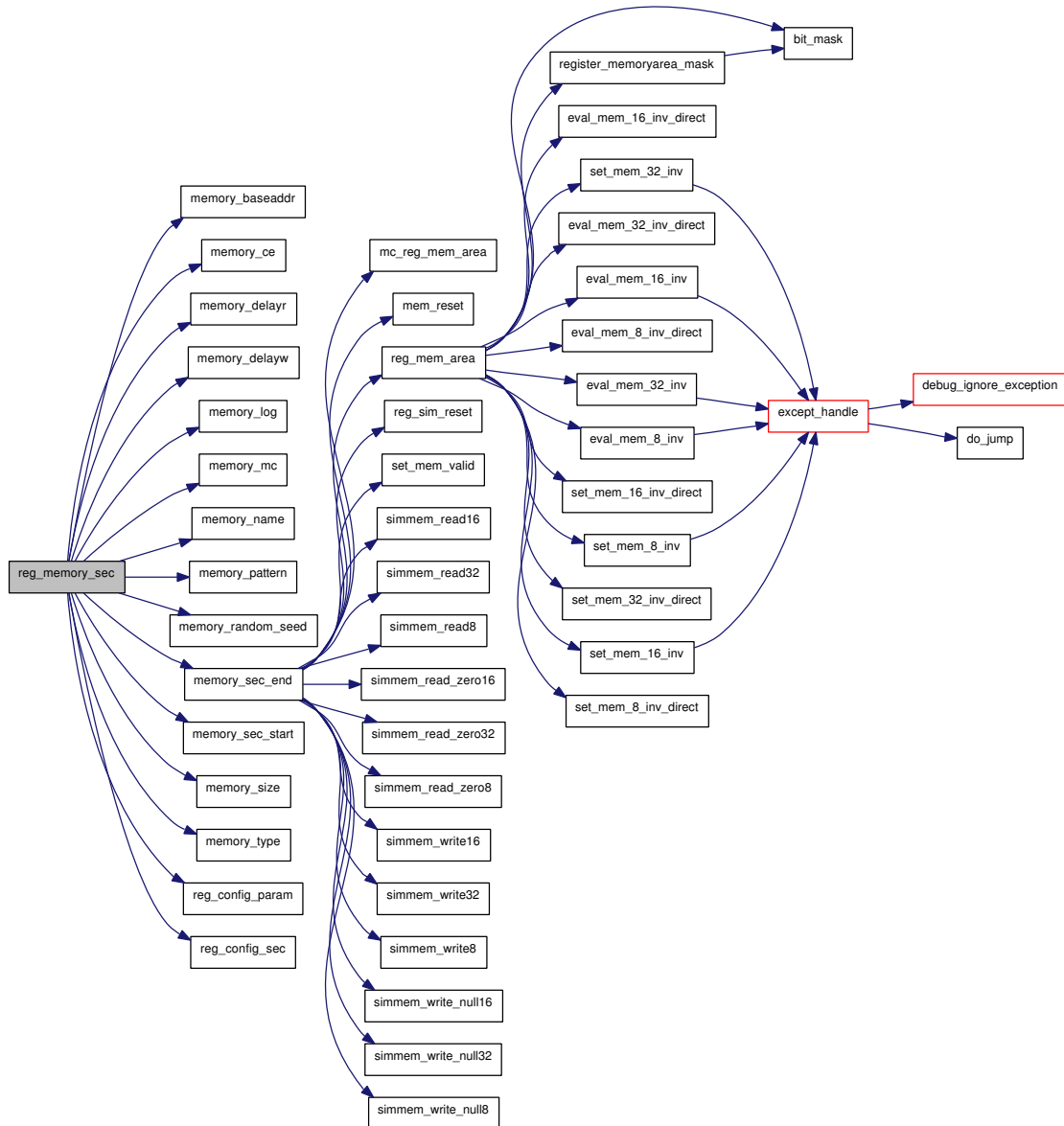



## 6.134 peripheral/ps2kbd.c File Reference

```
#include "config.h"
#include "port.h"
#include <stdlib.h>
#include <stdio.h>
#include "arch.h"
#include "pic.h"
#include "sim-config.h"
#include "abstract.h"
#include "sched.h"
#include "toplevel-support.h"
#include "sim-cmd.h"
```

Include dependency graph for ps2kbd.c:

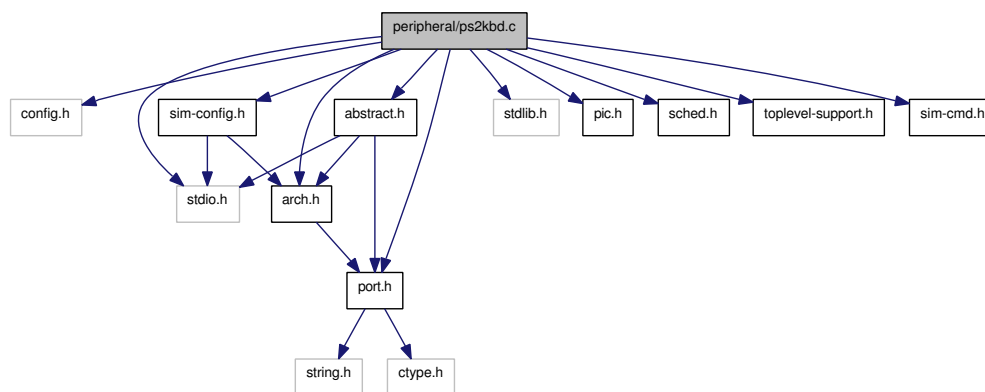

### Data Structures

- struct [kbd\\_state](#)

### Defines

- #define [KBD\\_CTRL](#) 4
- #define [KBD\\_DATA](#) 0
- #define [KBD\\_SPACE](#) 8
- #define [KBD\\_KCMD\\_RST](#) 0xFF
- #define [KBD\\_KCMD\\_DK](#) 0xF5
- #define [KBD\\_KCMD\\_EK](#) 0xF4
- #define [KBD\\_KCMD\\_ECHO](#) 0xFF
- #define [KBD\\_KCMD\\_SRL](#) 0xED
- #define [KBD\\_KRESP\\_RSTOK](#) 0xAA
- #define [KBD\\_KRESP\\_ECHO](#) 0xEE
- #define [KBD\\_KRESP\\_ACK](#) 0xFA

- #define `KBD_CCMD_RCB` 0x20
- #define `KBD_CCMD_WCB` 0x60
- #define `KBD_CCMD_ST1` 0xAA
- #define `KBD_CCMD_ST2` 0xAB
- #define `KBD_CCMD_DKI` 0xAD
- #define `KBD_CCMD_EKI` 0xAE
- #define `KBD_STATUS_OBF` 0x01
- #define `KBD_STATUS_IBF` 0x02
- #define `KBD_STATUS_SYS` 0x04
- #define `KBD_STATUS_A2` 0x08
- #define `KBD_STATUS_INH` 0x10
- #define `KBD_STATUS_MOBF` 0x20
- #define `KBD_STATUS_TO` 0x40
- #define `KBD_STATUS_PERR` 0x80
- #define `KBD_CCMDBYTE_INT` 0x01
- #define `KBD_CCMDBYTE_INT2` 0x02
- #define `KBD_CCMDBYTE_SYS` 0x04
- #define `KBD_CCMDBYTE_EN` 0x10
- #define `KBD_CCMDBYTE_EN2` 0x20
- #define `KBD_CCMDBYTE_XLAT` 0x40
- #define `KBD_MAX_BUF` 0x100
- #define `KBD_BAUD_RATE` 1200

## Functions

- static void `kbd_put` (struct `kbd_state` \*kbd, unsigned char c)
- static void `scan_decode` (struct `kbd_state` \*kbd, unsigned char c)
- static void `kbd_write8` (`oraddr_t` addr, `uint8_t` value, void \*dat)
- static `uint8_t` `kbd_read8` (`oraddr_t` addr, void \*dat)
- static void `kbd_job` (void \*dat)
- static void `kbd_reset` (void \*dat)
- static void `kbd_info` (void \*dat)
- static void `kbd_enabled` (union `param_val` val, void \*dat)
- static void `kbd_baseaddr` (union `param_val` val, void \*dat)
- static void `kbd_irq` (union `param_val` val, void \*dat)
- static void `kbd_rxfile` (union `param_val` val, void \*dat)
- static void \* `kbd_sec_start` ()
- static void `kbd_sec_end` (void \*dat)
- void `reg_kbd_sec` ()

## Variables

- struct {
  - unsigned char `shift`
  - unsigned char `code`
 } `scan_table` [128]



## 6.134.1 Define Documentation

6.134.1.1 **#define KBD\_BAUD\_RATE 1200**

6.134.1.2 **#define KBD\_CCMD\_DKI 0xAD**

6.134.1.3 **#define KBD\_CCMD\_EKI 0xAE**

6.134.1.4 **#define KBD\_CCMD\_RCB 0x20**

6.134.1.5 **#define KBD\_CCMD\_ST1 0xAA**

6.134.1.6 **#define KBD\_CCMD\_ST2 0xAB**

6.134.1.7 **#define KBD\_CCMD\_WCB 0x60**

6.134.1.8 **#define KBD\_CCMDBYTE\_EN 0x10**

6.134.1.9 **#define KBD\_CCMDBYTE\_EN2 0x20**

6.134.1.10 **#define KBD\_CCMDBYTE\_INT 0x01**

6.134.1.11 **#define KBD\_CCMDBYTE\_INT2 0x02**

6.134.1.12 **#define KBD\_CCMDBYTE\_SYS 0x04**

6.134.1.13 **#define KBD\_CCMDBYTE\_XLAT 0x40**

6.134.1.14 **#define KBD\_CTRL 4**

6.134.1.15 **#define KBD\_DATA 0**

6.134.1.16 **#define KBD\_KCMD\_DK 0xF5**

6.134.1.17 **#define KBD\_KCMD\_ECHO 0xFF**

6.134.1.18 **#define KBD\_KCMD\_EK 0xF4**

6.134.1.19 **#define KBD\_KCMD\_RST 0xFF**

6.134.1.20 **#define KBD\_KCMD\_SRL 0xED**

6.134.1.21 **#define KBD\_KRESP\_ACK 0xFA**

6.134.1.22 **#define KBD\_KRESP\_ECHO 0xEE**

6.134.1.23 **#define KBD\_KRESP\_RSTOK 0xAA**

6.134.1.24 **#define KBD\_MAX\_BUF 0x100**

6.134.1.25 **#define KBD\_SPACE 8**

6.134.1.26 **#define KBD\_STATUS\_A2 0x08**

6.134.1.27 **#define KBD\_STATUS\_BF 0x02**

6.134.1.28 **#define KBD\_STATUS\_INH 0x10**

6.134.1.29 **#define KBD\_STATUS\_MOBF 0x20**

6.134.1.30 **#define KBD\_STATUS\_OBF 0x01**

**6.134.2.6** `static void kbd_put (struct kbd_state * kbd, unsigned char c)` [static]

**6.134.2.7** `static uint8_t kbd_read8 (oraddr_t addr, void * dat)` [static]

Here is the call graph for this function:



**6.134.2.8** `static void kbd_reset (void * dat)` [static]

Here is the call graph for this function:

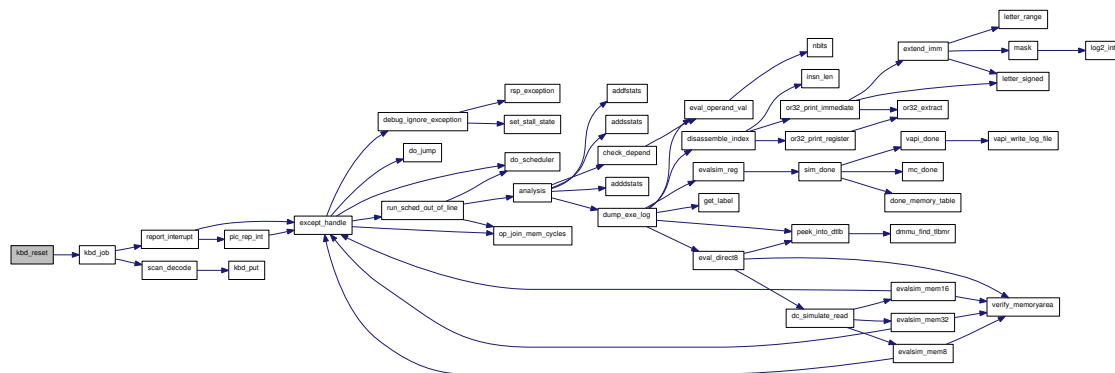

**6.134.2.9** `static void kbd_rxfile (union param_val val, void * dat)` [static]

Set the keyboard input file

Free any previously allocated value.

#### Parameters:

← *val* The value to use

← *dat* The `config` data structure

### 6.134.2.10 static void kbd\_sec\_end (void \* dat) [static]

Here is the call graph for this function:

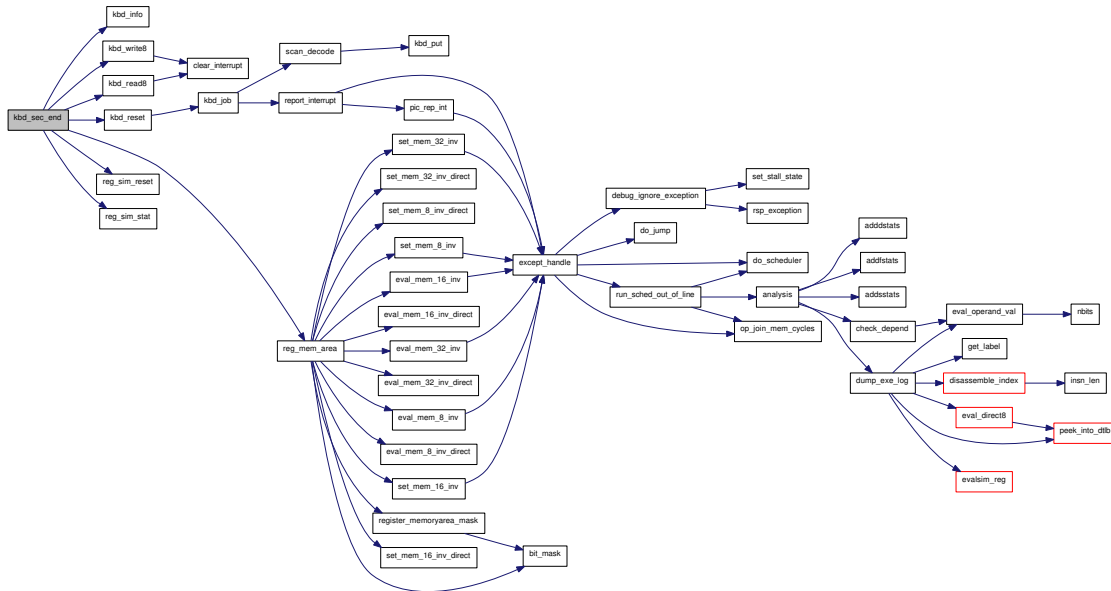

### 6.134.2.11 static void\* kbd\_sec\_start () [static]

Initialize a new keyboard configuration

ALL parameters are set explicitly to default values.

### 6.134.2.12 static void kbd\_write8 (oraddr\_t addr, uint8\_t value, void \* dat) [static]

Here is the call graph for this function:



### 6.134.2.13 void reg\_kbd\_sec ()

Here is the call graph for this function:

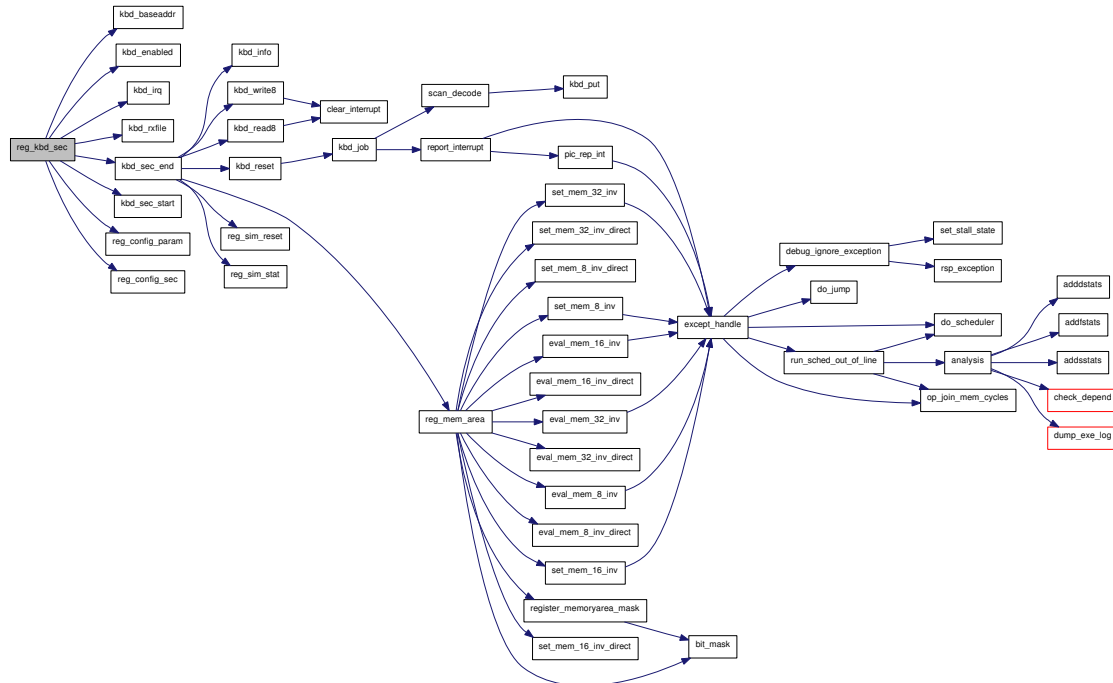

### 6.134.2.14 static void scan\_decode (struct kbd\_state \* kbd, unsigned char c) [static]

Here is the call graph for this function:



## 6.134.3 Variable Documentation

### 6.134.3.1 unsigned char code

### 6.134.3.2 const { ... } scan\_table[128] [static]

### 6.134.3.3 unsigned char shift

## 6.135 peripheral/ps2kbd.h File Reference

This graph shows which files directly or indirectly include this file:

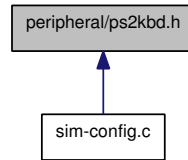

### Functions

- void [reg\\_kbd\\_sec](#) ()

### 6.135.1 Function Documentation

#### 6.135.1.1 void [reg\\_kbd\\_sec](#) ()

Here is the call graph for this function:

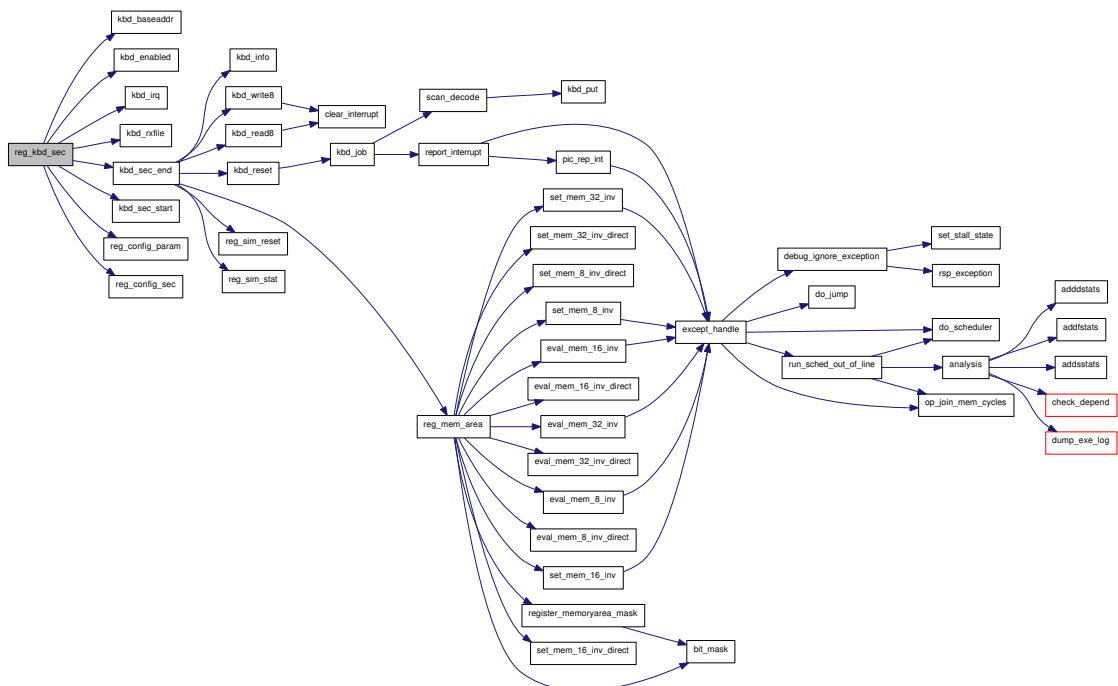



## 6.136 peripheral/vga.c File Reference

```
#include "config.h"
#include "port.h"
#include <stdlib.h>
#include <stdio.h>
#include "arch.h"
#include "sim-config.h"
#include "abstract.h"
#include "sched.h"
#include "toplevel-support.h"
```

Include dependency graph for vga.c:

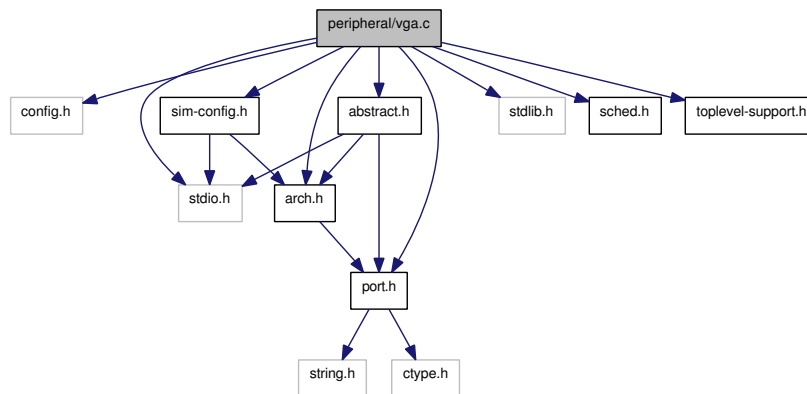

### Data Structures

- struct [vga\\_state](#)
- struct [BMP\\_HEADER](#)
- struct [INFOHEADER](#)

### Defines

- #define [VGA\\_CTRL](#) 0x00
- #define [VGA\\_STAT](#) 0x04
- #define [VGA\\_HTIM](#) 0x08
- #define [VGA\\_VTIM](#) 0x0c
- #define [VGA\\_HVLEN](#) 0x10
- #define [VGA\\_VBARA](#) 0x14
- #define [VGA\\_VBARB](#) 0x18
- #define [VGA\\_CLUTA](#) 0x800
- #define [VGA\\_CLUTB](#) 0xc00
- #define [VGA\\_MASK](#) 0xff
- #define [VGA\\_ADDR\\_SPACE](#) 1024

- #define `VGA_CTRL_VEN` 0x00000001
- #define `VGA_CTRL_CD` 0x00000300
- #define `VGA_CTRL_PC` 0x00000400

## Functions

- void `vga_write32` (`oraddr_t` addr, `uint32_t` value, void \*dat)
- `uint32_t` `vga_read32` (`oraddr_t` addr, void \*dat)
- static int `vga_dump_image` (char \*filename, struct `vga_state` \*vga)
- void `vga_job` (void \*dat)
- void `vga_reset` (void \*dat)
- static void `vga_enabled` (union `param_val` val, void \*dat)
- static void `vga_baseaddr` (union `param_val` val, void \*dat)
- static void `vga_irq` (union `param_val` val, void \*dat)
- static void `vga_refresh_rate` (union `param_val` val, void \*dat)
- static void `vga_filename` (union `param_val` val, void \*dat)
- static void \* `vga_sec_start` ()
- static void `vga_sec_end` (void \*dat)
- void `reg_vga_sec` ()

## 6.136.1 Define Documentation

6.136.1.1 **#define VGA\_ADDR\_SPACE 1024**

6.136.1.2 **#define VGA\_CLUTA 0x800**

6.136.1.3 **#define VGA\_CLUTB 0xc00**

6.136.1.4 **#define VGA\_CTRL 0x00**

6.136.1.5 **#define VGA\_CTRL\_CD 0x00000300**

6.136.1.6 **#define VGA\_CTRL\_PC 0x00000400**

6.136.1.7 **#define VGA\_CTRL\_VEN 0x00000001**

6.136.1.8 **#define VGA\_HTIM 0x08**

6.136.1.9 **#define VGA\_HVLEN 0x10**

6.136.1.10 **#define VGA\_MASK 0xff**

6.136.1.11 **#define VGA\_STAT 0x04**

6.136.1.12 **#define VGA\_VBARA 0x14**

6.136.1.13 **#define VGA\_VBARB 0x18**

6.136.1.14 **#define VGA\_VTIM 0x0c**

## 6.136.2 Function Documentation

6.136.2.1 **void reg\_vga\_sec ()**

Create a new VGA configuration

ALL parameters are set explicitly to default values. Alternative naming for file parameter supported.

Here is the call graph for this function:

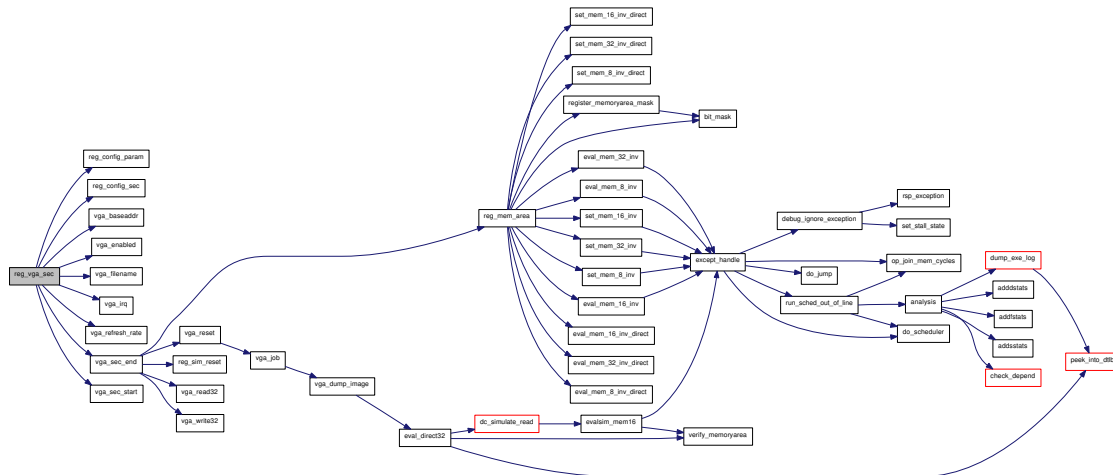

**6.136.2.2** `static void vga_baseaddr (union param_val val, void * dat) [static]`

**6.136.2.3** `static int vga_dump_image (char * filename, struct vga_state * vga) [static]`

Here is the call graph for this function:

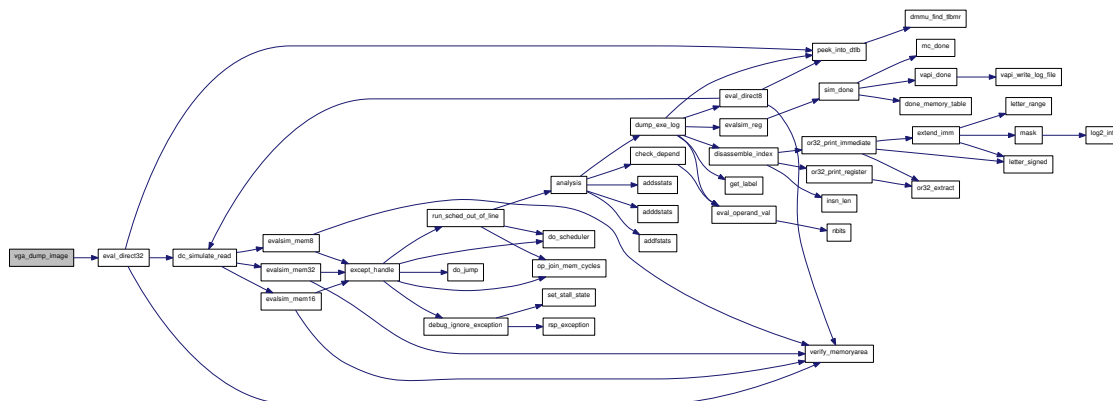

**6.136.2.4** `static void vga_enabled (union param_val val, void * dat) [static]`

**6.136.2.5** `static void vga_filename (union param_val val, void * dat) [static]`

Set the VGA output file

Free any previously allocated value.

**Parameters:**

← *val* The value to use

← *dat* The `config` data structure

6.136.2.6 static void vga\_irq (union param\_val val, void \* dat) [static]

6.136.2.7 void vga\_job (void \* dat)

Here is the call graph for this function:

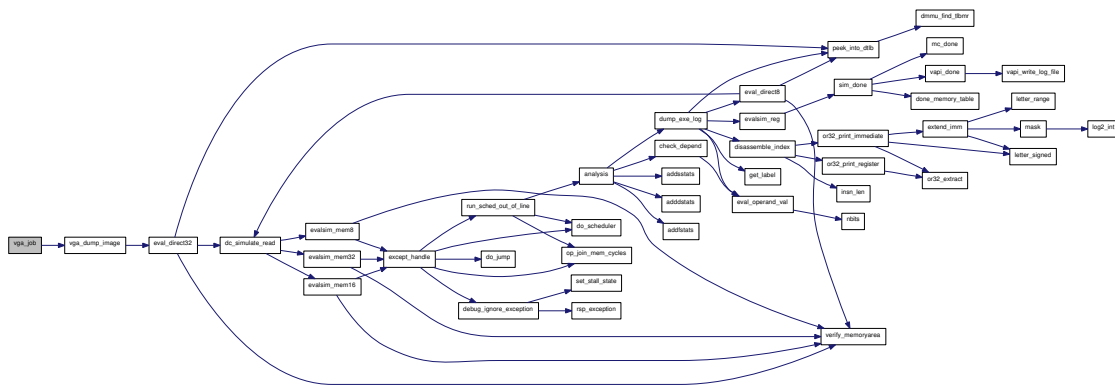

6.136.2.8 uint32\_t vga\_read32 (oraddr\_t addr, void \* dat)

6.136.2.9 static void vga\_refresh\_rate (union param\_val val, void \* dat) [static]

6.136.2.10 void vga\_reset (void \* dat)

Here is the call graph for this function:

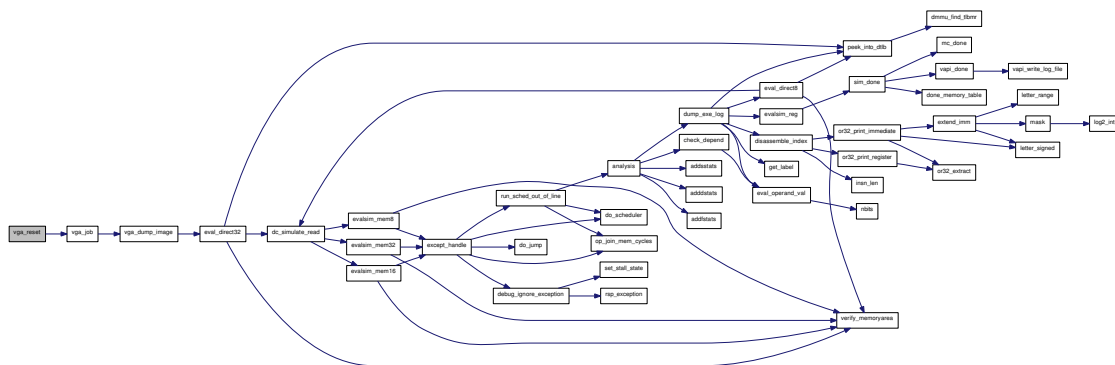

### 6.136.2.11 static void vga\_sec\_end (void \* dat) [static]

Here is the call graph for this function:

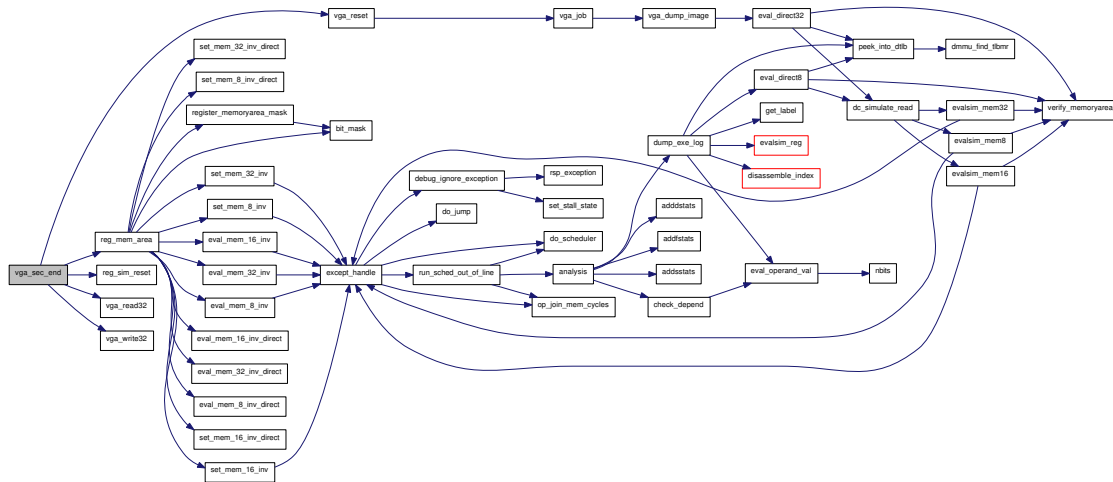

### 6.136.2.12 static void\* vga\_sec\_start () [static]

Initialize a new VGA configuration

ALL parameters are set explicitly to default values.

### 6.136.2.13 void vga\_write32 (oraddr\_t addr, uint32\_t value, void \* dat)



## 6.138 pic/pic.c File Reference

```
#include "config.h"
#include "port.h"
#include <stdlib.h>
#include <stdio.h>
#include "arch.h"
#include "abstract.h"
#include "pic.h"
#include "opcode/or32.h"
#include "spr-defs.h"
#include "execute.h"
#include "except.h"
#include "sprs.h"
#include "sim-config.h"
#include "sched.h"
```

Include dependency graph for pic.c:

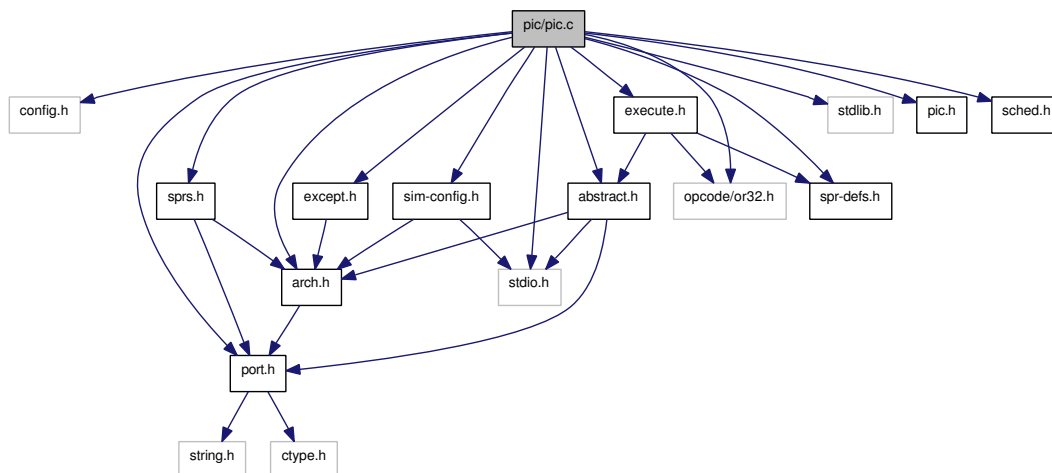

### Functions

- void [pic\\_reset](#) (void)
- static void [pic\\_rep\\_int](#) (void \*dat)
- void [pic\\_ints\\_en](#) (void)
- void [report\\_interrupt](#) (int line)
- void [clear\\_interrupt](#) (int line)
- static void [pic\\_enabled](#) (union [param\\_val](#) val, void \*dat)
- static void [pic\\_edge\\_trigger](#) (union [param\\_val](#) val, void \*dat)
- void [reg\\_pic\\_sec](#) ()



## Variables

- struct pic `pic_state_int` = { 1, 1 }
- struct pic \* `pic_state` = &`pic_state_int`

## 6.138.1 Function Documentation

### 6.138.1.1 void `clear_interrupt` (int *line*)

### 6.138.1.2 static void `pic_edge_trigger` (union `param_val val`, void \* *dat*) [static]

Enable or disable edge triggering of interrupts

#### Parameters:

- ← *val* The value to use
- ← *dat* The `config` data structure (not used here)

### 6.138.1.3 static void `pic_enabled` (union `param_val val`, void \* *dat*) [static]

Enable or disable the programmable interrupt controller

Set the corresponding field in the UPR

#### Parameters:

- ← *val* The value to use
- ← *dat* The `config` data structure (not used here)

### 6.138.1.4 void `pic_ints_en` (void)

Here is the call graph for this function:

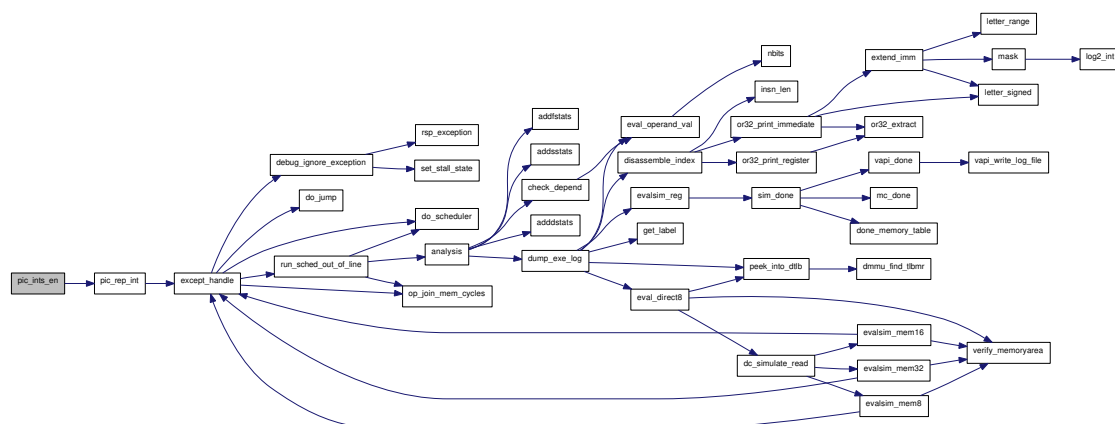

### 6.138.1.5 static void pic\_rep\_int (void \* dat) [static]

Here is the call graph for this function:

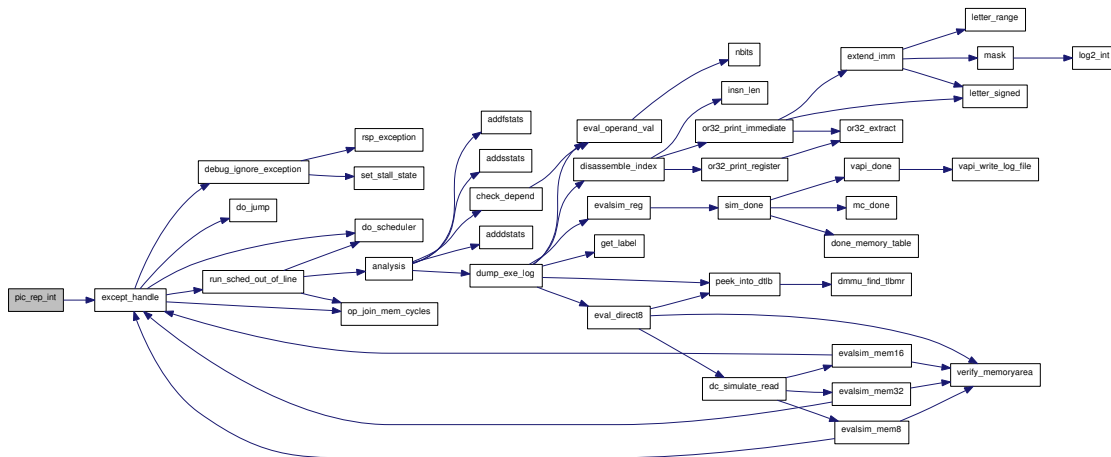

### 6.138.1.6 void pic\_reset (void)

### 6.138.1.7 void reg\_pic\_sec ()

Initialize a new interrupt controller configuration

ALL parameters are set explicitly to default values in [init\\_defconfig\(\)](#)

Here is the call graph for this function:

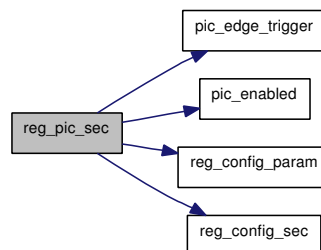

### 6.138.1.8 void report\_interrupt (int line)

Here is the call graph for this function:



## 6.138.2 Variable Documentation

### 6.138.2.1 struct pic\* pic\_state = &pic\_state\_int

### 6.138.2.2 struct pic pic\_state\_int = { 1, 1 }

## 6.139 pic/pic.h File Reference

This graph shows which files directly or indirectly include this file:

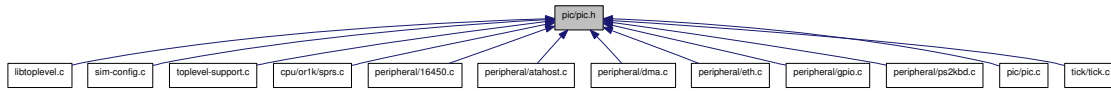

### Functions

- void [pic\\_reset](#) ()
- void [report\\_interrupt](#) (int line)
- void [clear\\_interrupt](#) (int line)
- void [pic\\_ints\\_en](#) ()
- void [reg\\_pic\\_sec](#) ()

### 6.139.1 Function Documentation

#### 6.139.1.1 void clear\_interrupt (int line)

#### 6.139.1.2 void pic\_ints\_en ()

Here is the call graph for this function:

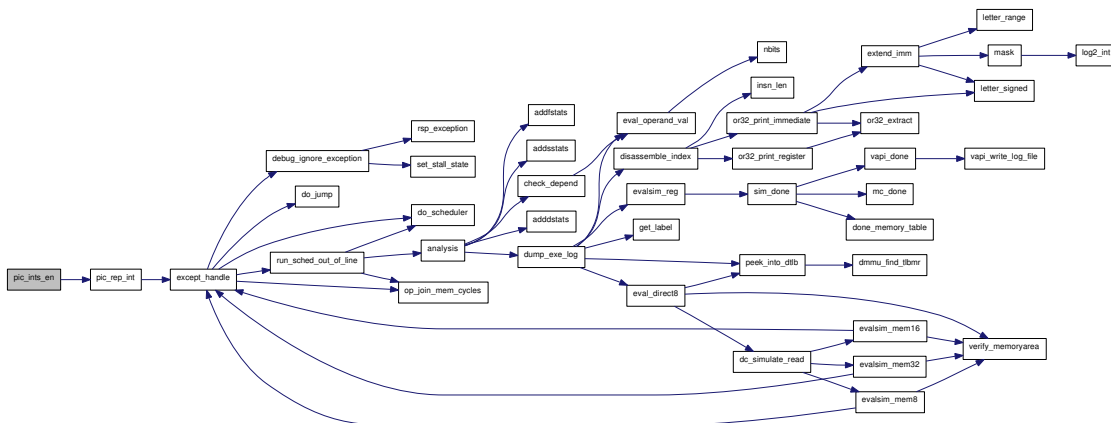

#### 6.139.1.3 void pic\_reset ()

#### 6.139.1.4 void reg\_pic\_sec ()

Initialize a new interrupt controller configuration

ALL parameters are set explicitly to default values in [init\\_defconfig\(\)](#)

Here is the call graph for this function:

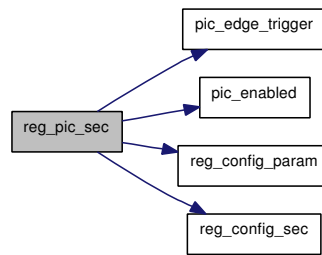

### 6.139.1.5 void report\_interrupt (int line)

Here is the call graph for this function:

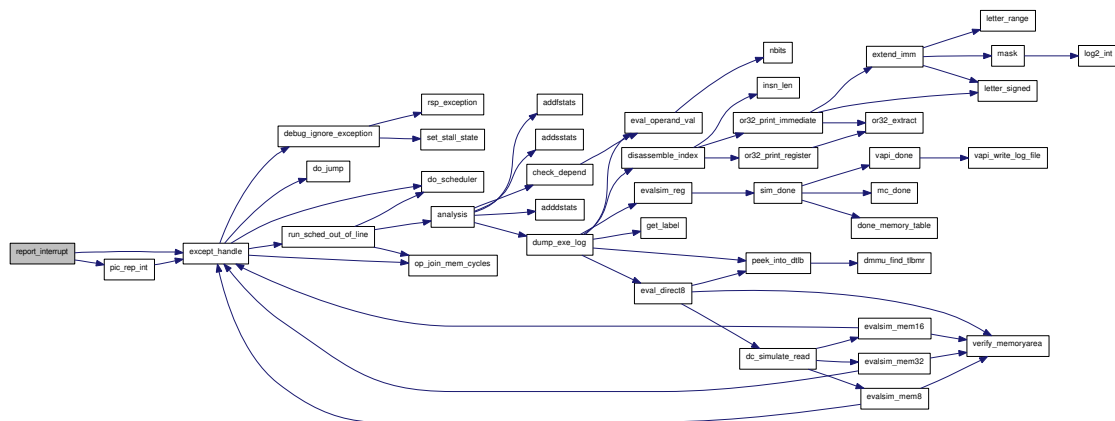

## 6.140 pm/pm.c File Reference

```
#include "config.h"
#include "spr-defs.h"
#include "execute.h"
#include "sim-config.h"
```

Include dependency graph for pm.c:

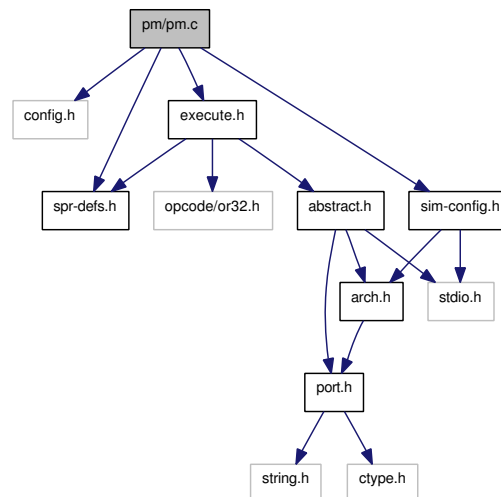

### Functions

- void [pm\\_reset](#) ()
- static void [pm\\_enabled](#) (union [param\\_val](#) val, void \*dat)
- void [reg\\_pm\\_sec](#) ()

### 6.140.1 Function Documentation

#### 6.140.1.1 static void [pm\\_enabled](#) (union [param\\_val](#) val, void \*dat) [static]

Enable or disable power management

Set the corresponding field in the UPR

#### Parameters:

- ← *val* The value to use
- ← *dat* The [config](#) data structure (not used here)

#### 6.140.1.2 void [pm\\_reset](#) ()

Reset power management

Initializes PMR register by clearing it.

### 6.140.1.3 void reg\_pm\_sec ()

Set up a new power management configuration section

Here is the call graph for this function:

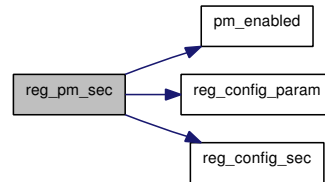

## 6.141 pm/pm.h File Reference

This graph shows which files directly or indirectly include this file:

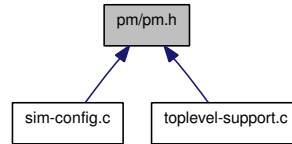

### Functions

- void [pm\\_reset](#) ()
- void [reg\\_pm\\_sec](#) ()

#### 6.141.1 Function Documentation

##### 6.141.1.1 void `pm_reset` ()

Reset power management

Initializes PMR register by clearing it.

##### 6.141.1.2 void `reg_pm_sec` ()

Set up a new power management configuration section

Here is the call graph for this function:

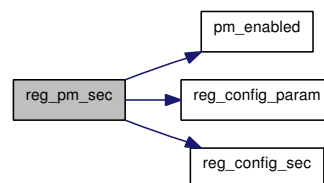



## 6.142 port/isblank.c File Reference

```
#include "config.h"
```

Include dependency graph for isblank.c:

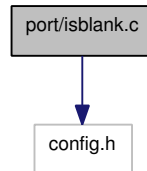

### Functions

- `int isblank (int c)`

#### 6.142.1 Function Documentation

##### 6.142.1.1 `int isblank (int c)`

## 6.143 port/port.h File Reference

```
#include <string.h>
```

```
#include <ctype.h>
```

Include dependency graph for port.h:

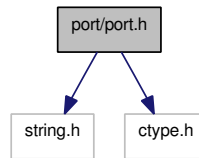

### Defines

- #define [PRIx16](#) "x"
- #define [PRIx8](#) "x"

### Functions

- char \* [strndup](#) (const char \*s, size\_t n)
- int [isblank](#) (int c)

#### 6.143.1 Define Documentation

6.143.1.1 #define [PRIx16](#) "x"

6.143.1.2 #define [PRIx8](#) "x"

#### 6.143.2 Function Documentation

6.143.2.1 int [isblank](#) (int *c*)

6.143.2.2 char\* [strndup](#) (const char \* *s*, size\_t *n*)

## 6.144 port/strndup.c File Reference

```
#include "config.h"
```

Include dependency graph for strndup.c:

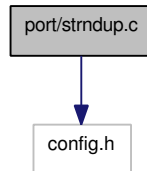

### Functions

- char \* [strndup](#) (const char \*s, size\_t n)

#### 6.144.1 Function Documentation

##### 6.144.1.1 char\* strndup (const char \* s, size\_t n)

## 6.145 profiler.c File Reference

```
#include "config.h"
#include "port.h"
#include "profiler.h"
#include "sim-config.h"
#include "argtable2.h"
```

Include dependency graph for profiler.c:

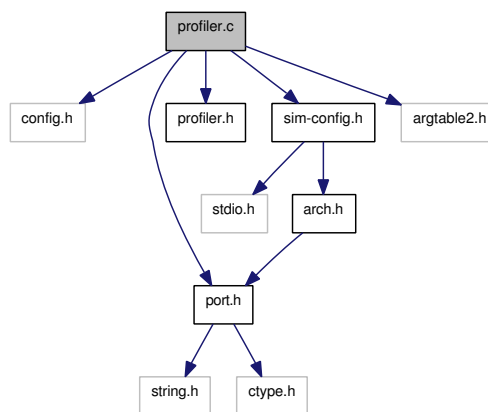

### Data Structures

- struct [stack\\_struct](#)

### Defines

- #define [MAX\\_STACK](#) 1024

### Functions

- int [prof\\_acquire](#) (const char \*fprofname)
- static void [prof\\_print](#) ()
- void [prof\\_set](#) (int \_quiet, int \_cumulative)
- int [main\\_profiler](#) (int argc, char \*argv[], int just\_help)

### Variables

- struct [func\\_struct](#) [prof\\_func](#) [MAX\_FUNCS]
- int [prof\\_nfuncs](#) = 0
- int [prof\\_cycles](#) = 0
- static struct [stack\\_struct](#) [stack](#) [MAX\_STACK]
- static int [nstack](#) = 0
- static int [maxstack](#) = 0

- static int `ntotcalls` = 0
- static int `nfuncalls` = 0
- static int `cumulative` = 0
- static int `quiet` = 0
- static FILE \* `fprof` = 0

## 6.145.1 Define Documentation

### 6.145.1.1 `#define MAX_STACK 1024`

Maximum stack frames that can be profiled

## 6.145.2 Function Documentation

### 6.145.2.1 `int main_profiler (int argc, char * argv[], int just_help)`

Parse the arguments for the profiling utility

Updated by Jeremy Bennett to use `argtable2`. Also has an option just to print help, for use with the CLI.

#### Parameters:

- ← *argc* Number of command args
- ← *argv* Vector of the command args
- ← *just\_help* If 1 (true), ignore *argc* & *argv* and just print out the help message without parsing args

#### Returns:

- 0 on success, 1 on failure

Here is the call graph for this function:

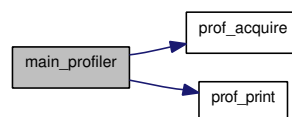

### 6.145.2.2 `int prof_acquire (const char * fprofname)`

Acquire data from profiler file

#### Parameters:

- ← *fprofname* Data file to analyse

#### Returns:

- 0 on success, return code otherwise

**6.145.2.3** `static void prof_print ()` [static]

**6.145.2.4** `void prof_set (int _quiet, int _cumulative)`

### 6.145.3 Variable Documentation

**6.145.3.1** `int cumulative = 0` [static]

Whether we are in cumulative mode

**6.145.3.2** `FILE* fprof = 0` [static]

File to read from

**6.145.3.3** `int maxstack = 0` [static]

Max depth

**6.145.3.4** `int nfunccalls = 0` [static]

Number of covered calls

**6.145.3.5** `int nstack = 0` [static]

Current depth

**6.145.3.6** `int ntotcalls = 0` [static]

Number of total calls

**6.145.3.7** `int prof_cycles = 0`

Global: current cycles

**6.145.3.8** `struct func_struct prof_func[MAX_FUNCS]`

Global: data about functions

**6.145.3.9** `int prof_nfuncs = 0`

Global: total number of functions

**6.145.3.10** `int quiet = 0` [static]

Whether we should not report warnings

**6.145.3.11 struct stack\_struct stack[MAX\_STACK] [static]**

Representation of the stack

## 6.146 profiler.h File Reference

This graph shows which files directly or indirectly include this file:

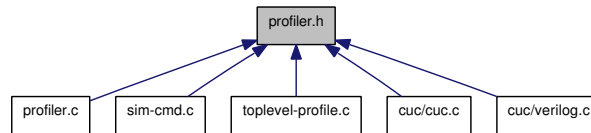

### Data Structures

- struct [func\\_struct](#)

### Defines

- #define [MAX\\_FUNCS](#) 1024

### Functions

- int [prof\\_acquire](#) (const char \*fprofname)
- void [prof\\_set](#) (int \_quiet, int \_cumulative)
- int [main\\_profiler](#) (int argc, char \*argv[ ], int just\_help)

### Variables

- struct [func\\_struct](#) [prof\\_func](#) [MAX\_FUNCS]
- int [prof\\_nfuncs](#)
- int [prof\\_cycles](#)

#### 6.146.1 Define Documentation

##### 6.146.1.1 #define MAX\_FUNCS 1024

Maximum number of functions that can be profiled

#### 6.146.2 Function Documentation

##### 6.146.2.1 int main\_profiler (int *argc*, char \* *argv*[ ], int *just\_help*)

Parse the arguments for the profiling utility

Updated by Jeremy Bennett to use argtable2. Also has an option just to print help, for use with the CLI.

#### Parameters:

- ← *argc* Number of command args
- ← *argv* Vector of the command args



← *just\_help* If 1 (true), ignore argc & argv and just print out the help message without parsing args

**Returns:**

0 on success, 1 on failure

Here is the call graph for this function:

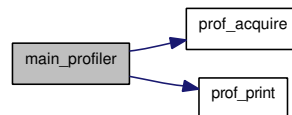
**6.146.2.2 int prof\_acquire (const char \* *fprofname*)**

Acquire data from profiler file

**Parameters:**

← *fprofname* Data file to analyse

**Returns:**

0 on success, return code otherwise

**6.146.2.3 void prof\_set (int *\_quiet*, int *\_cumulative*)****6.146.3 Variable Documentation****6.146.3.1 int prof\_cycles**

Global: current cycles

**6.146.3.2 struct func\_struct prof\_func[MAX\_FUNCS]**

Global: data about functions

**6.146.3.3 int prof\_nfuncs**

Global: total number of functions

## 6.147 sim-cmd.c File Reference

```
#include "config.h"
#include <stdlib.h>
#include <unistd.h>
#include <stdio.h>
#include "sim-cmd.h"
#include "sim-config.h"
#include "execute.h"
#include "labels.h"
#include "gdbcomm.h"
#include "sched.h"
#include "toplevel-support.h"
#include "dumpverilog.h"
#include "profiler.h"
#include "mprofiler.h"
#include "trace.h"
#include "debug-unit.h"
#include "stats.h"
#include "sprs.h"
#include "dcache-model.h"
#include "branch-predict.h"
#include "debug.h"
#include "cuc.h"
#include "rsp-server.h"
```

Include dependency graph for sim-cmd.c:

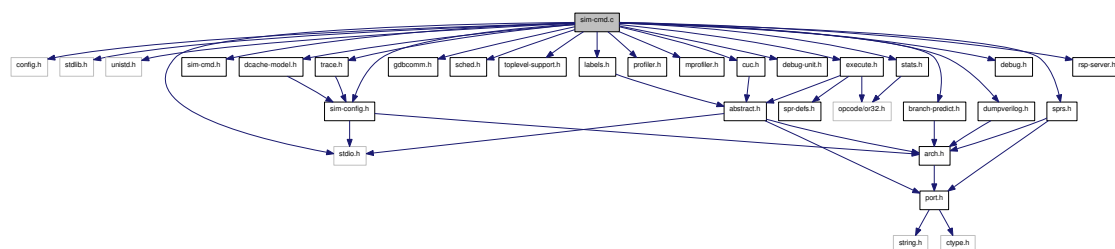

## Data Structures

- struct [sim\\_stat](#)
- struct [sim\\_command](#)

## Functions

- void [reg\\_sim\\_stat](#) (void(\*stat\_func)(void \*dat), void \*dat)
- void [reenter\\_int](#) (void \*dat)
- static int [sim\\_cmd\\_quit](#) (int argc, char \*\*argv)
- static int [sim\\_cmd\\_help](#) (int argc, char \*\*argv)
- static int [sim\\_cmd\\_trace](#) (int argc, char \*\*argv)
- static int [sim\\_cmd\\_dm](#) (int argc, char \*\*argv)
- static int [sim\\_cmd\\_dv](#) (int argc, char \*\*argv)
- static int [sim\\_cmd\\_dh](#) (int argc, char \*\*argv)
- static int [sim\\_cmd\\_pm](#) (int argc, char \*\*argv)
- static int [sim\\_cmd\\_cm](#) (int argc, char \*\*argv)
- static int [sim\\_cmd\\_pr](#) (int argc, char \*\*argv)
- static int [sim\\_cmd\\_pc](#) (int argc, char \*\*argv)
- static int [sim\\_cmd\\_breaks](#) (int argc, char \*\*argv)
- static int [sim\\_cmd\\_break](#) (int argc, char \*\*argv)
- static int [sim\\_cmd\\_r](#) (int argc, char \*\*argv)
- static int [sim\\_cmd\\_de](#) (int argc, char \*\*argv)
- static int [sim\\_cmd\\_reset](#) (int argc, char \*\*argv)
- static int [sim\\_cmd\\_hist](#) (int argc, char \*\*argv)
- void [check\\_insn\\_exec](#) (void \*dat)
- void [print\\_insn\\_exec](#) (void \*dat)
- static int [sim\\_cmd\\_run](#) (int argc, char \*\*argv)
- static int [sim\\_cmd\\_stall](#) (int argc, char \*\*argv)
- static int [sim\\_cmd\\_unstall](#) (int argc, char \*\*argv)
- static int [sim\\_cmd\\_stats](#) (int argc, char \*\*argv)
- static int [sim\\_cmd\\_info](#) (int argc, char \*\*argv)
- static int [sim\\_cmd\\_setdbch](#) (int argc, char \*\*argv)
- static int [sim\\_cmd\\_debug](#) (int argc, char \*\*argv)
- static int [sim\\_cmd\\_profile](#) (int argc, char \*\*argv)
- static int [sim\\_cmd\\_mprofile](#) (int argc, char \*\*argv)
- static int [sim\\_cmd\\_cuc](#) (int argc, char \*\*argv)
- static int [sim\\_cmd\\_set](#) (int argc, char \*\*argv)
- static char \* [strip\\_space](#) (char \*str)
- void [handle\\_sim\\_command](#) (void)

## Variables

- static long long [to\\_insn\\_num](#)
- static struct [sim\\_stat](#) \* [sim\\_stats](#) = NULL
- static struct [sim\\_command](#) [sim\\_commands](#) []

## 6.147.1 Function Documentation

### 6.147.1.1 void check\_insn\_exec (void \* dat)

Here is the call graph for this function:

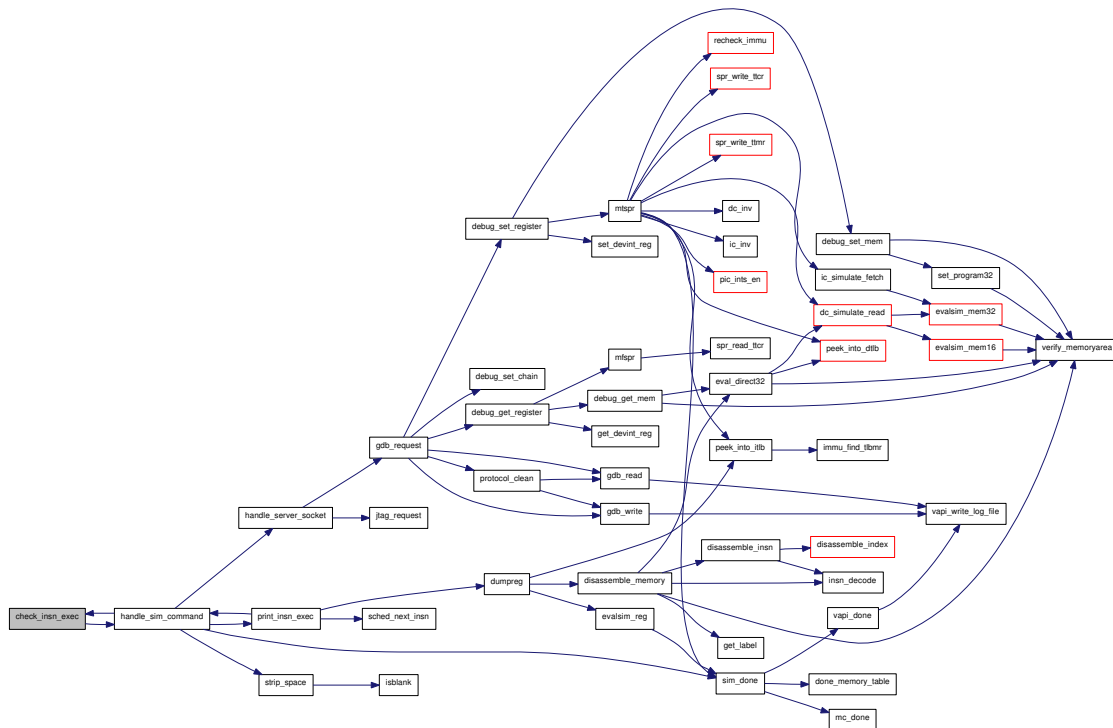

## 6.147.1.2 void handle\_sim\_command (void)

Here is the call graph for this function:

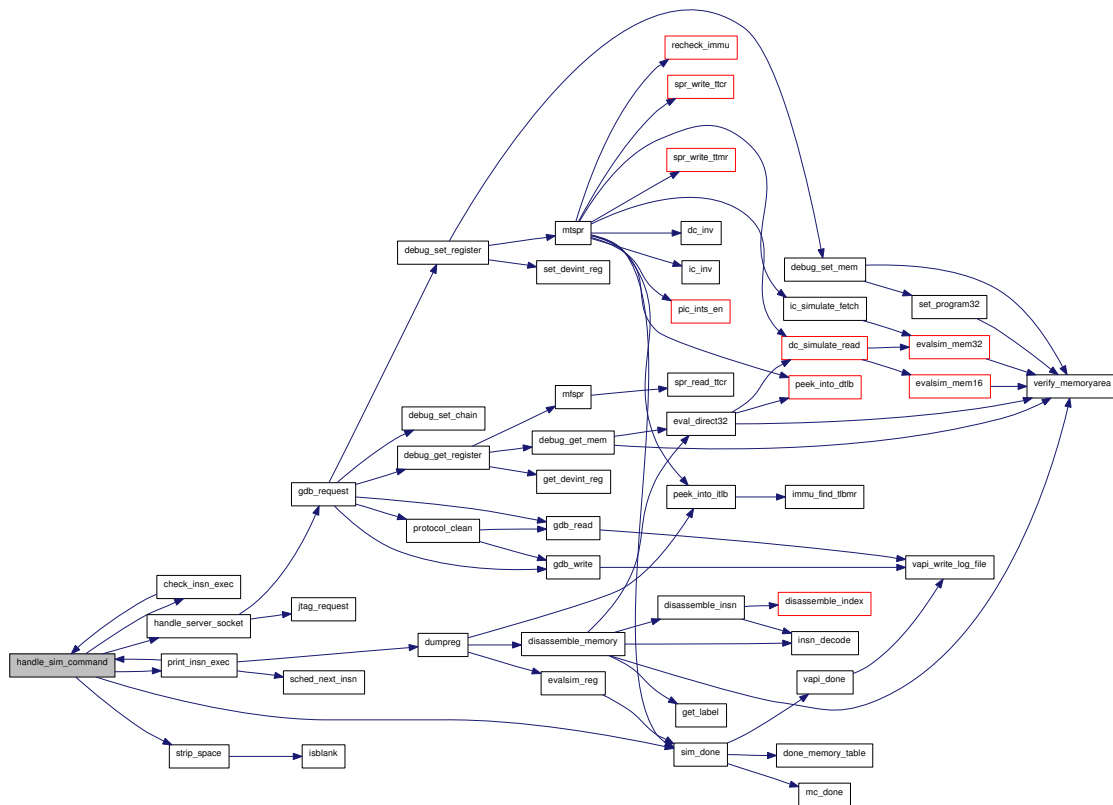

### 6.147.1.3 void print\_insn\_exec (void \* dat)

Here is the call graph for this function:

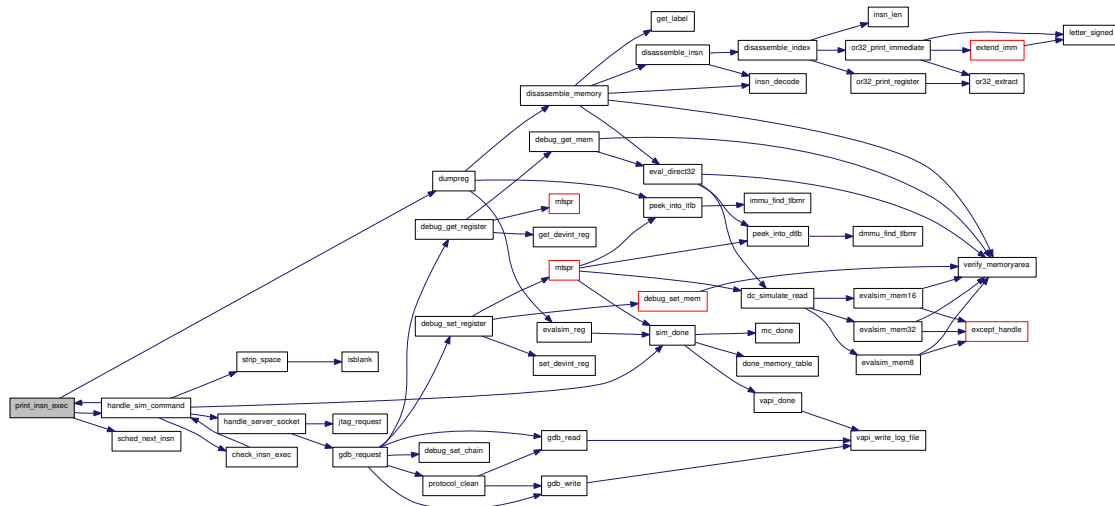

### 6.147.1.4 void reenter\_int (void \* dat)

Here is the call graph for this function:

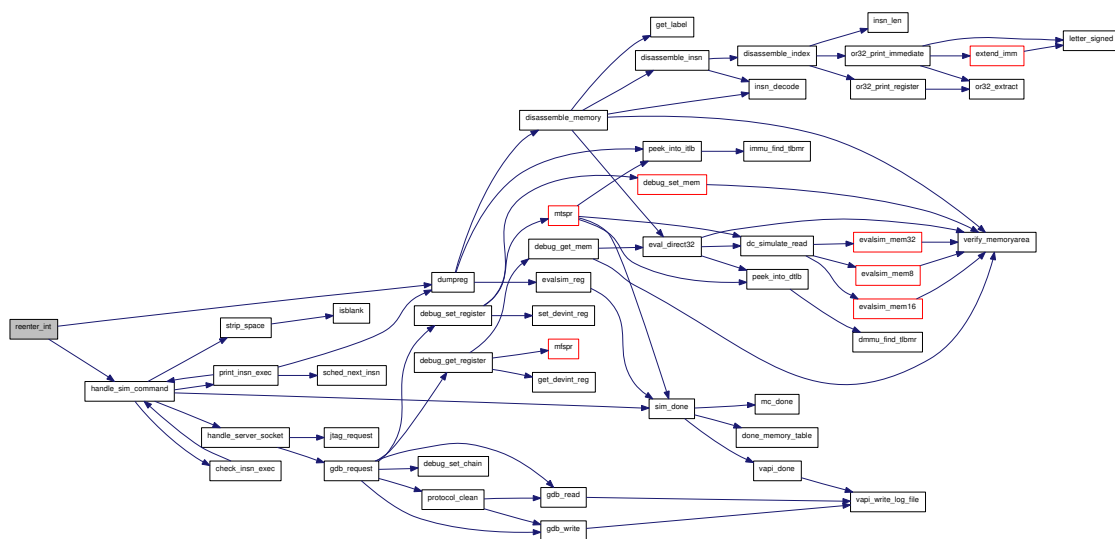

**6.147.1.5** void reg\_sim\_stat (void\*)(void \*dat) stat\_func, void \* dat)

**6.147.1.6** static int sim\_cmd\_break (int argc, char \*\* argv) [static]

Here is the call graph for this function:

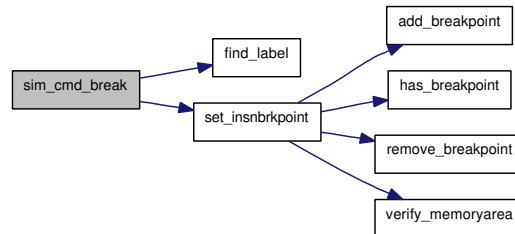

**6.147.1.7** static int sim\_cmd\_breaks (int argc, char \*\* argv) [static]

Here is the call graph for this function:



**6.147.1.8** static int sim\_cmd\_cm (int argc, char \*\* argv) [static]

Here is the call graph for this function:

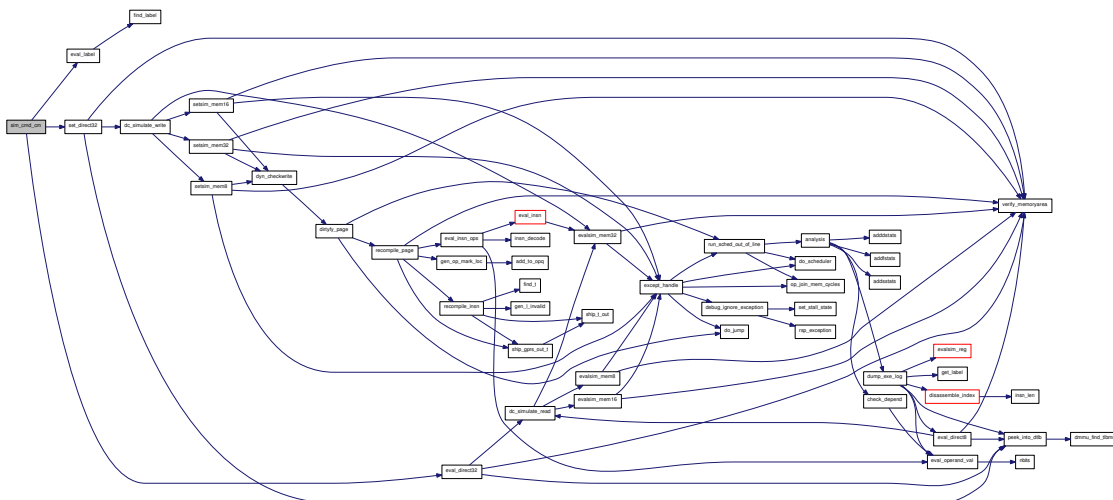





6.147.1.9 static int sim\_cmd\_cuc (int argc, char \*\* argv) [static]

Here is the call graph for this function:

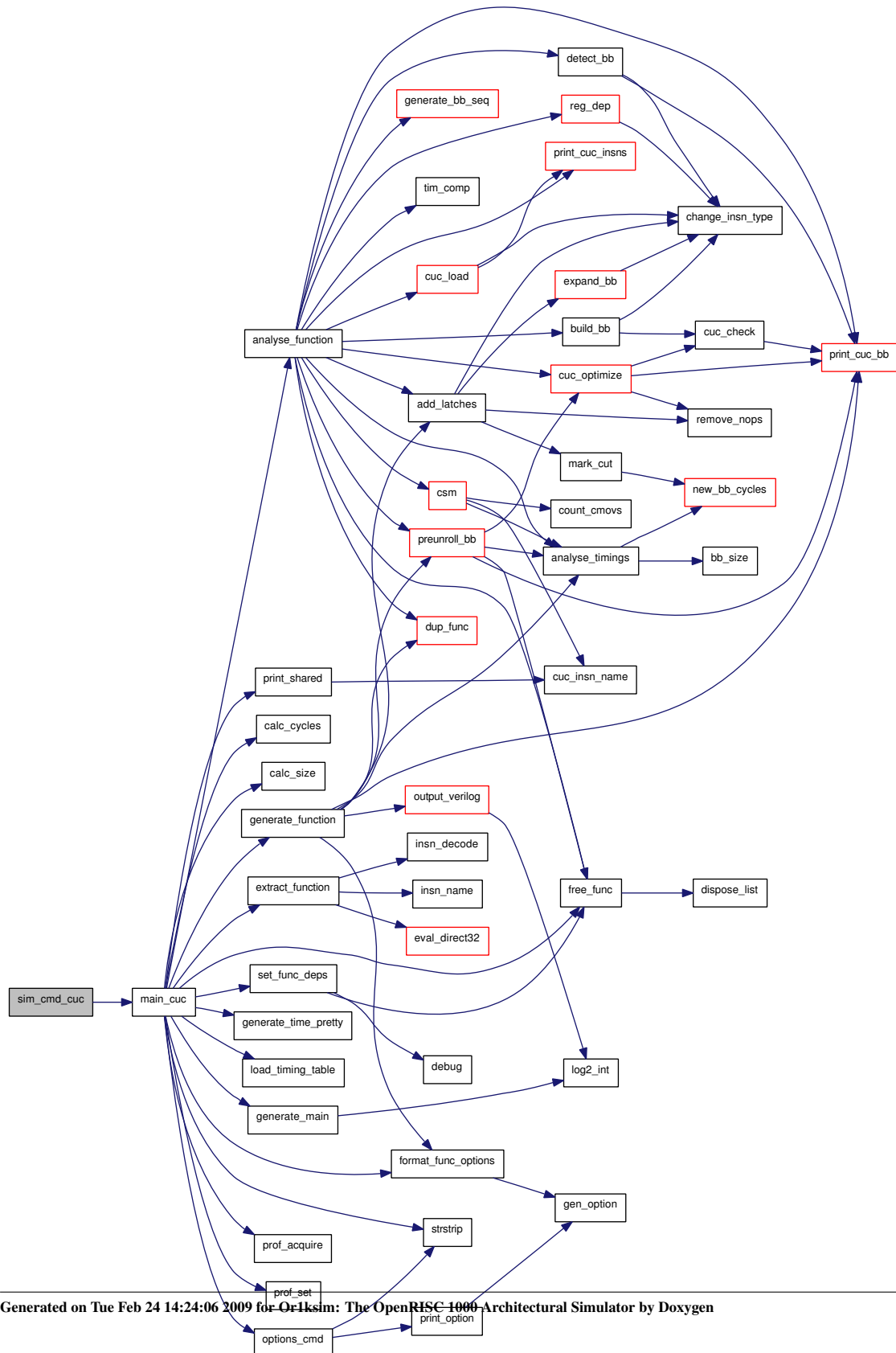









6.147.1.23 static int sim\_cmd\_quit (int argc, char \*\* argv) [static]

Here is the call graph for this function:

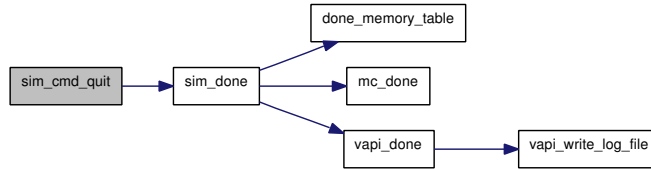

6.147.1.24 static int sim\_cmd\_r (int argc, char \*\* argv) [static]

Here is the call graph for this function:

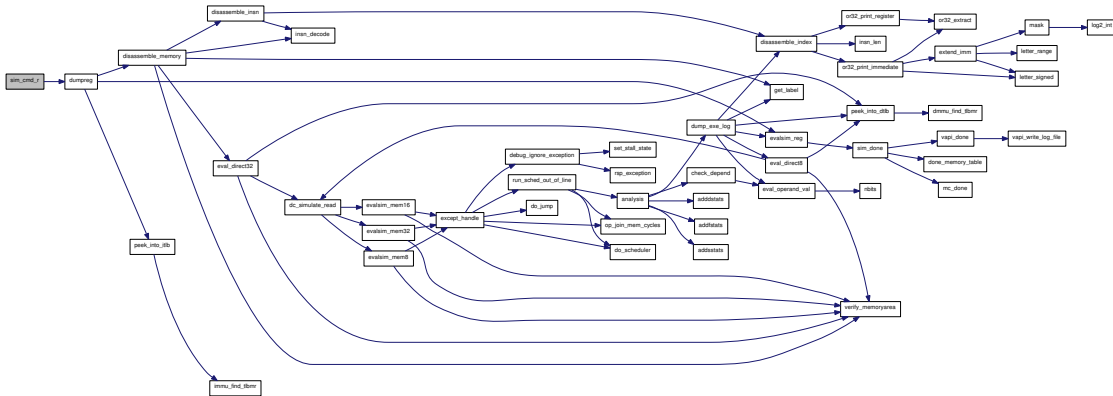

6.147.1.25 static int sim\_cmd\_reset (int argc, char \*\* argv) [static]

Here is the call graph for this function:

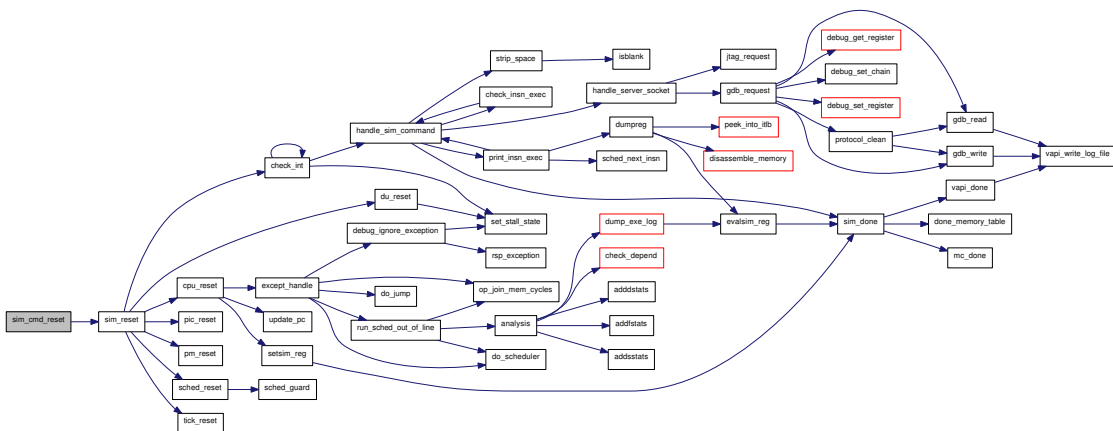

**6.147.1.26 static int sim\_cmd\_run (int argc, char \*\* argv) [static]**

Here is the call graph for this function:

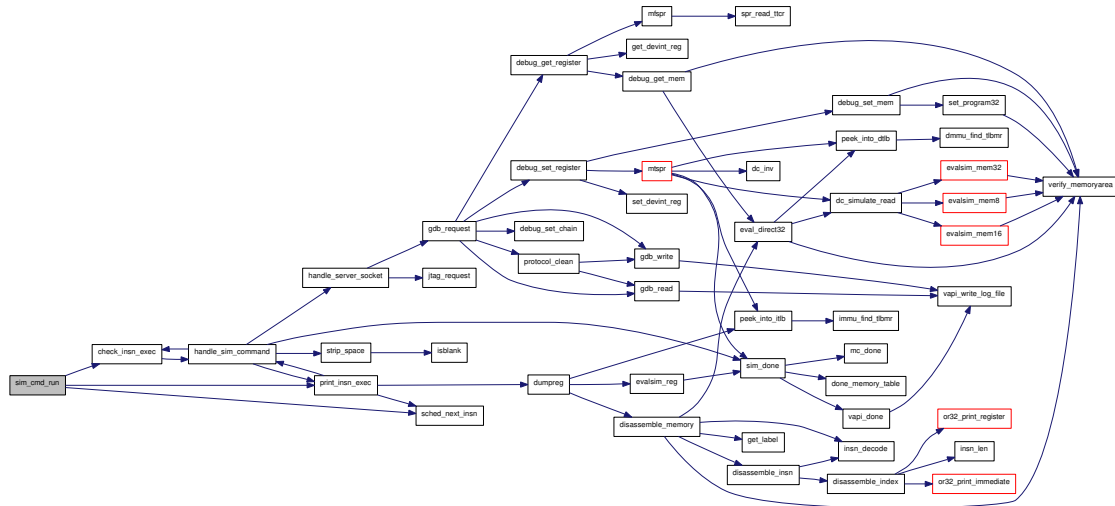

**6.147.1.27 static int sim\_cmd\_set (int argc, char \*\* argv) [static]**

Here is the call graph for this function:



**6.147.1.28 static int sim\_cmd\_setdbch (int argc, char \*\* argv) [static]**

Here is the call graph for this function:

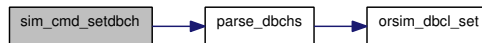

**6.147.1.29 static int sim\_cmd\_stall (int argc, char \*\* argv) [static]**

Here is the call graph for this function:



### 6.147.1.30 `static int sim_cmd_stats (int argc, char ** argv) [static]`

Here is the call graph for this function:

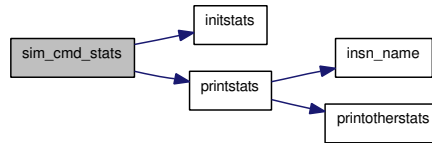

### 6.147.1.31 `static int sim_cmd_trace (int argc, char ** argv) [static]`

Here is the call graph for this function:

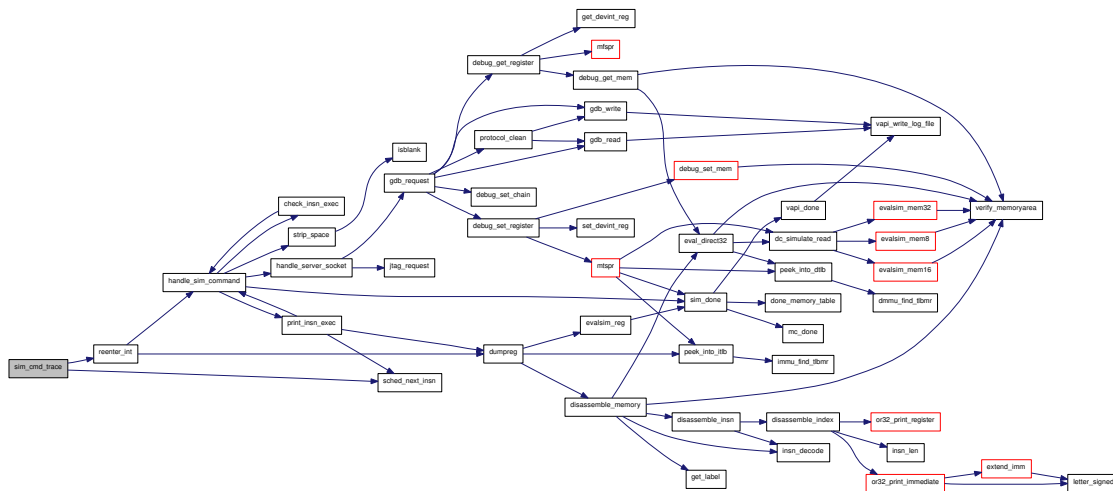

### 6.147.1.32 `static int sim_cmd_unstall (int argc, char ** argv) [static]`

Here is the call graph for this function:



### 6.147.1.33 `static char* strip_space (char * str) [static]`

Here is the call graph for this function:





## 6.147.2 Variable Documentation

### 6.147.2.1 struct sim\_command sim\_commands[] [static]

**Initial value:**

```
{
  {"q", sim_cmd_quit},
  {"help", sim_cmd_help},
  {"t", sim_cmd_trace},
  {"dm", sim_cmd_dm},
  {"dv", sim_cmd_dv},
  {"dh", sim_cmd_dh},
  {"pm", sim_cmd_pm},
  {"cm", sim_cmd_cm},
  {"pr", sim_cmd_pr},
  {"pc", sim_cmd_pc},
  {"breaks", sim_cmd_breaks},
  {"break", sim_cmd_break},
  {"r", sim_cmd_r},
  {"de", sim_cmd_de},
  {"reset", sim_cmd_reset},
  {"hist", sim_cmd_hist},
  {"stall", sim_cmd_stall},
  {"unstall", sim_cmd_unstall},
  {"stats", sim_cmd_stats},
  {"info", sim_cmd_info},
  {"run", sim_cmd_run},
  {"setdbch", sim_cmd_setdbch},
  {"debug", sim_cmd_debug},
  {"profile", sim_cmd_profile},
  {"mprofile", sim_cmd_mprofile},
  {"cuc", sim_cmd_cuc},
  {"set", sim_cmd_set},
  {NULL, NULL}
}
```

### 6.147.2.2 struct sim\_stat\* sim\_stats = NULL [static]

### 6.147.2.3 long long to\_insn\_num [static]



## 6.149 sim-config.c File Reference

```
#include "config.h"
#include "port.h"
#include <stdlib.h>
#include "sim-config.h"
#include "vapi.h"
#include "cuc.h"
#include "cpu-config.h"
#include "memory.h"
#include "dmmu.h"
#include "immu.h"
#include "dcache-model.h"
#include "icache-model.h"
#include "pic.h"
#include "pm.h"
#include "branch-predict.h"
#include "debug-unit.h"
#include "mc.h"
#include "16450.h"
#include "dma.h"
#include "eth.h"
#include "gpio.h"
#include "vga.h"
#include "fb.h"
#include "ps2kbd.h"
#include "atahost.h"
#include "generic.h"
#include "execute.h"
#include "spr-defs.h"
#include "debug.h"
#include "misc.h"
#include "argtable2.h"
```



## 6.149.1 Function Documentation

### 6.149.1.1 void base\_include (union param\_val val, void \* dat)

Here is the call graph for this function:

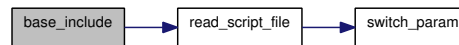

### 6.149.1.2 void init\_defconfig (void)

Set default configuration parameters for fixed components

These values are held in the global `config` variable. Parameter orders match the order in the corresponding section registration function and documentation.

Also set some starting values for `runtime` elements.

Here is the call graph for this function:



### 6.149.1.3 int parse\_args (int argc, char \* argv[ ])

Parse the arguments for the standalone simulator

Updated by Jeremy Bennett to use `argtable2`.

#### Parameters:

- ← *argc* Number of command args
- ← *argv* Vector of the command args

#### Returns:

0 on success, 1 on failure

Here is the call graph for this function:

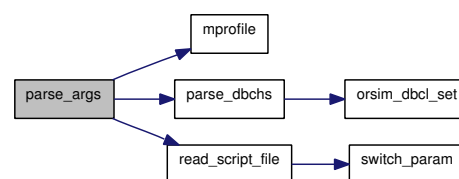

**6.149.1.4 void print\_config (void)**

Print the current configuration

Here is the call graph for this function:

**6.149.1.5 static void read\_script\_file (const char \**filename*) [static]**

Here is the call graph for this function:









### 6.149.1.9 static void reg\_sim\_sec () [static]

Register the functions to handle a section sim

This section does not allocate dynamically a data structure holding its `config` information. It's all in the global `config.sim` data structure. Therefore it does not need a start and end function to initialize default values (although it might be clearer to do so). The default values are set in `init_defconfig()`.

New preferred parameter names are introduced (`_file` for filenames), but the legacy names (`_fn`) are also present for backwards compatibility

Here is the call graph for this function:

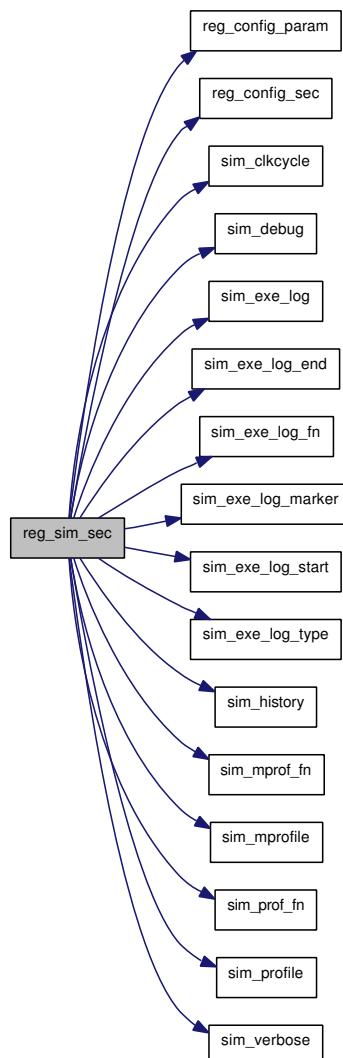

**6.149.1.10** `static int set_config (int argc, char ** argv) [static]`

Here is the call graph for this function:

**6.149.1.11** `void set_config_command (int argc, char ** argv)`

Here is the call graph for this function:

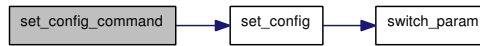
**6.149.1.12** `void sim_clkcycle (union param_val val, void * dat)`

Set the clock cycle time.

Value must be an integer followed by one of ps, ns, us or ms.

If a valid time is not presented, the value is unchanged.

**Parameters:**

← *val* The value to use

← *dat* The `config` data structure (not used here)

**6.149.1.13** `void sim_debug (union param_val val, void * dat)`

Set the simulator debug message level

Value must be in the range 0 (no messages) to 9. Values outside this range are converted to the nearer end of the range with a warning.

**Parameters:**

← *val* The value to use

← *dat* The `config` data structure (not used here)

**6.149.1.14** void sim\_exe\_log (union param\_val val, void \* dat)

**6.149.1.15** void sim\_exe\_log\_end (union param\_val val, void \* dat)

**6.149.1.16** void sim\_exe\_log\_fn (union param\_val val, void \* dat)

**6.149.1.17** void sim\_exe\_log\_marker (union param\_val val, void \* dat)

**6.149.1.18** void sim\_exe\_log\_start (union param\_val val, void \* dat)

**6.149.1.19** void sim\_exe\_log\_type (union param\_val val, void \* dat)

Set the execution log type

Value must be one of default, hardware, simple or software. Invalid values are ignored with a warning.

**Parameters:**

← *val* The value to use

← *dat* The `config` data structure (not used here)

**6.149.1.20** void sim\_history (union param\_val val, void \* dat)

**6.149.1.21** void sim\_mprof\_fn (union param\_val val, void \* dat)

**6.149.1.22** void sim\_mprofile (union param\_val val, void \* dat)

**6.149.1.23** void sim\_prof\_fn (union param\_val val, void \* dat)

**6.149.1.24** void sim\_profile (union param\_val val, void \* dat)

**6.149.1.25** void sim\_verbose (union param\_val val, void \* dat)

**6.149.1.26** static void switch\_param (char \* param, struct config\_param \* cur\_param)  
[static]

## 6.149.2 Variable Documentation

**6.149.2.1** struct config config

**6.149.2.2** struct config\_section\* cur\_section

**6.149.2.3** struct runtime runtime

**6.149.2.4** struct config\_section\* sections = NULL

## 6.150 sim-config.h File Reference

```
#include <stdio.h>
```

```
#include "arch.h"
```

Include dependency graph for sim-config.h:

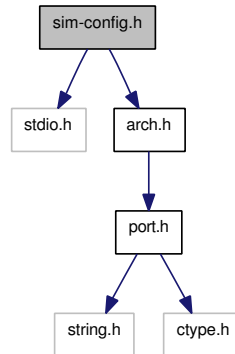

### Data Structures

- struct `config`
- struct `config::pic`
- struct `runtime`
- union `param_val`
- struct `config_section`

### Defines

- #define `MAX_SBUF_LEN` 256
- #define `EXE_LOG_HARDWARE` 0
- #define `EXE_LOG_SIMPLE` 1
- #define `EXE_LOG_SOFTWARE` 2
- #define `STR_SIZE` 256
- #define `CHECK_INT_TIME` 100000
- #define `PRINTF(x...)` `fprintf (runtime.sim.fout, x)`

### Enumerations

- enum `param_t` {  
    `paramt_none` = 0, `paramt_str`, `paramt_word`, `paramt_int`,  
    `paramt_longlong`, `paramt_addr` }

### Functions

- void `set_config_command` (int argc, char \*\*argv)
- void `init_defconfig` (void)

- int `parse_args` (int argc, char \*argv[])
- void `print_config` (void)
- void `reg_config_param` (struct `config_section` \*sec, const char \*param, enum `param_t` type, void(\*param\_cb)(union `param_val`, void \*))
- struct `config_section` \* `reg_config_sec` (const char \*section, void>(\*sec\_start)(void), void(\*sec\_end)(void \*))
- void `reg_config_secs` ()

## Variables

- struct `config config`
- struct `runtime runtime`
- struct `config_section` \* `cur_section`
- int `do_stats`

### 6.150.1 Define Documentation

6.150.1.1 `#define CHECK_INT_TIME 100000`

6.150.1.2 `#define EXE_LOG_HARDWARE 0`

6.150.1.3 `#define EXE_LOG_SIMPLE 1`

6.150.1.4 `#define EXE_LOG_SOFTWARE 2`

6.150.1.5 `#define MAX_SBUF_LEN 256`

6.150.1.6 `#define PRINTF(x...) fprintf (runtime.sim.fout, x)`

6.150.1.7 `#define STR_SIZE 256`

### 6.150.2 Enumeration Type Documentation

6.150.2.1 `enum param_t`

Enum of all possible parameter types

Enumerator:

*paramt\_none*

*paramt\_str*

*paramt\_word*

*paramt\_int*

*paramt\_longlong*

*paramt\_addr*

### 6.150.3 Function Documentation

#### 6.150.3.1 void init\_defconfig (void)

Set default configuration parameters for fixed components

These values are held in the global `config` variable. Parameter orders match the order in the corresponding section registration function and documentation.

Also set some starting values for `runtime` elements.

Here is the call graph for this function:

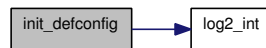

#### 6.150.3.2 int parse\_args (int argc, char \* argv[ ])

Parse the arguments for the standalone simulator

Updated by Jeremy Bennett to use argtable2.

##### Parameters:

- ← *argc* Number of command args
- ← *argv* Vector of the command args

##### Returns:

- 0 on success, 1 on failure

Here is the call graph for this function:

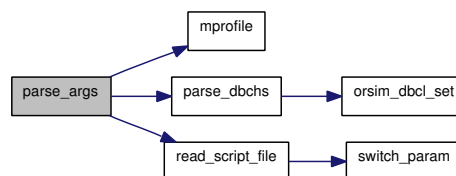

#### 6.150.3.3 void print\_config (void)

Print the current configuration

Here is the call graph for this function:





**6.150.3.4** void reg\_config\_param (struct config\_section \* sec, const char \* param, enum param\_t type, void\*(\*)(union param\_val, void \*) param\_cb)

**6.150.3.5** struct config\_section\* reg\_config\_sec (const char \* section, void \*(\*)(void) sec\_start, void\*(\*)(void \*) sec\_end) [read]

**6.150.3.6** void reg\_config\_secs ()

Here is the call graph for this function:

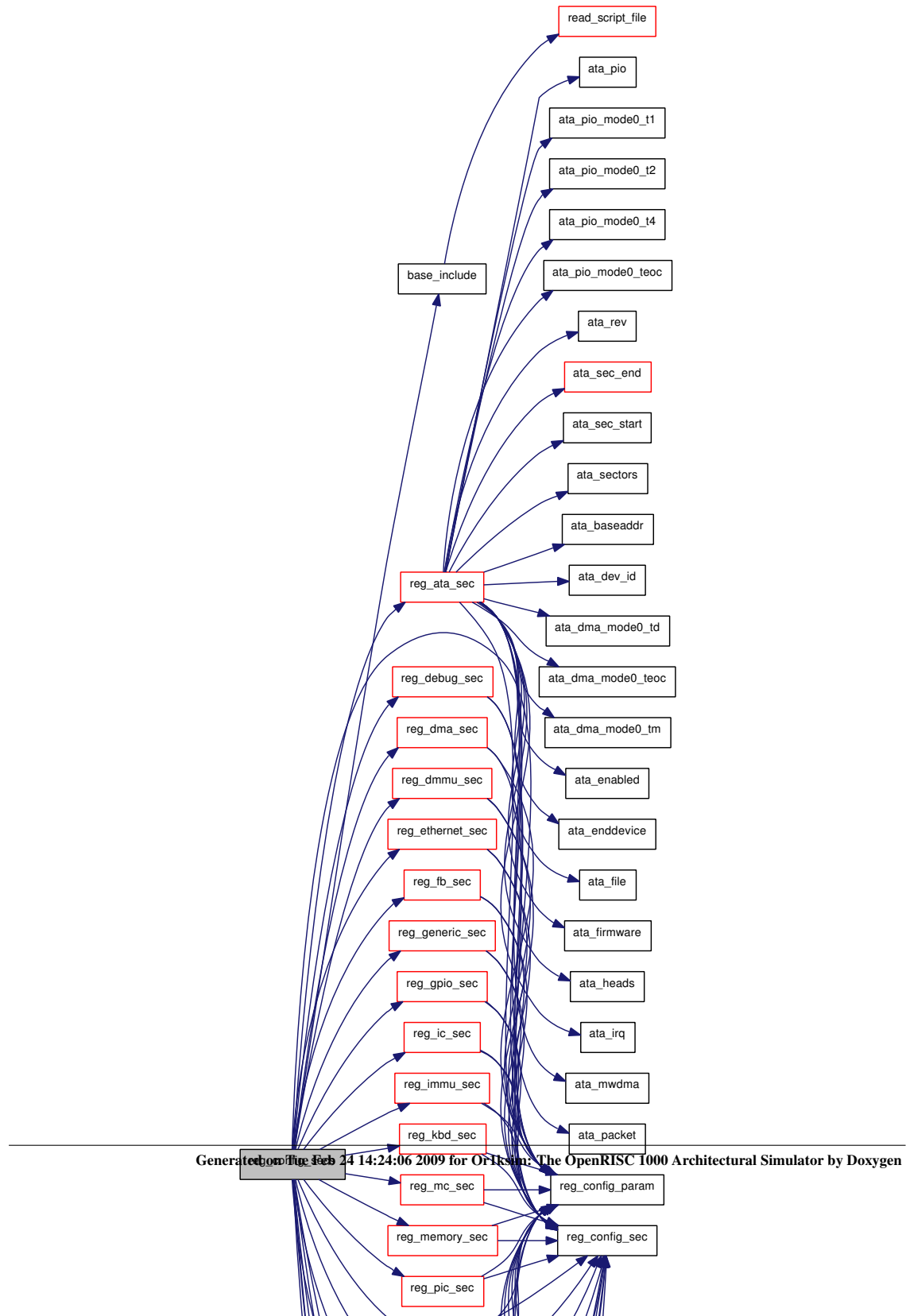



### 6.150.3.7 void set\_config\_command (int argc, char \*\* argv)

Here is the call graph for this function:

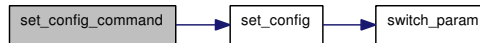

## 6.150.4 Variable Documentation

### 6.150.4.1 struct config config

### 6.150.4.2 struct config\_section\* cur\_section

### 6.150.4.3 int do\_stats

Whether we are doing statistical analysis. Globally available

### 6.150.4.4 struct runtime runtime

## 6.151 support/dbchs.h File Reference

This graph shows which files directly or indirectly include this file:

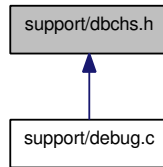

## 6.152 support/debug.c File Reference

```
#include "config.h"
#include "port.h"
#include <stdlib.h>
#include <stdio.h>
#include <stdarg.h>
#include "arch.h"
#include "sim-config.h"
#include "debug.h"
#include "dbchs.h"
```

Include dependency graph for debug.c:

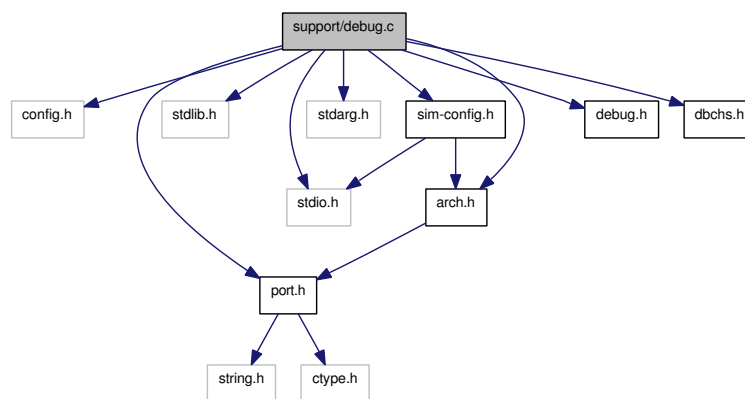

### Defines

- #define [\\_\\_ORSIM\\_NO\\_DEC\\_DBCH](#)
- #define [DECLARE\\_DEBUG\\_CHANNEL](#)(dbch) char \_\_orsim\_dbch\_##dbch[] = "\0"#dbch;
- #define [DECLARE\\_DEBUG\\_CHANNEL](#)(dbch) \_\_orsim\_dbch\_##dbch,

### Functions

- void [orsim\\_dbg\\_log](#) (enum [\\_\\_ORSIM\\_DEBUG\\_CLASS](#) dbcl, const char \*dbch, const char \*function, const char \*format,...)
- void [orsim\\_dbcl\\_set](#) (enum [\\_\\_ORSIM\\_DEBUG\\_CLASS](#) dbcl, char \*dbch, int on)
- void [orsim\\_dbcl\\_set\\_name](#) (enum [\\_\\_ORSIM\\_DEBUG\\_CLASS](#) dbcl, const char \*dbch, int on)
- void [parse\\_dbchs](#) (const char \*str)
- void [debug](#) (int level, const char \*format,...)

### Variables

- static char \* [\\_\\_orsim\\_dbchs](#) []
- static const char \* [debug\\_classes](#) [] = { "trace", "fixme", "warn", "err" }

## 6.152.1 Define Documentation

6.152.1.1 `#define __ORSIM_NO_DEC_DBCH`

6.152.1.2 `#define DECLARE_DEBUG_CHANNEL(dbch) __orsim_dbch_##dbch,`

6.152.1.3 `#define DECLARE_DEBUG_CHANNEL(dbch) char __orsim_dbch_##dbch[] =  
"\0"#dbch;`

## 6.152.2 Function Documentation

6.152.2.1 `void debug (int level, const char * format, ...)`

Internal debug function

Print the message if the level is greater than or equal to that specified in the configuration.

### Parameters:

- ← *level* The debug level of this message
- ← *format* Varargs format string
- ← ... The varargs required by the string

6.152.2.2 `void orsim_dbcl_set (enum __ORSIM_DEBUG_CLASS dbcl, char * dbch, int on)`

6.152.2.3 `void orsim_dbcl_set_name (enum __ORSIM_DEBUG_CLASS dbcl, const char * dbch,  
int on)`

Here is the call graph for this function:



6.152.2.4 `void orsim_dbg_log (enum __ORSIM_DEBUG_CLASS dbcl, const char * dbch, const  
char * function, const char * format, ...)`

6.152.2.5 `void parse_dbchs (const char * str)`

Here is the call graph for this function:



## 6.152.3 Variable Documentation

6.152.3.1 `char* __orsim_dbchs[] [static]`

6.152.3.2 `const char* debug_classes[] = { "trace", "fixme", "warn", "err" } [static]`

## 6.153 support/debug.h File Reference

This graph shows which files directly or indirectly include this file:

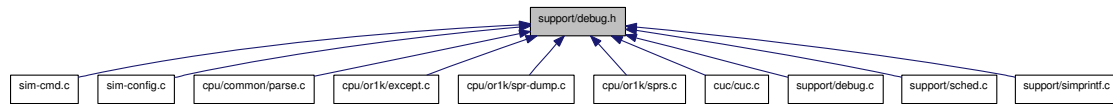

### Defines

- #define `__ORSIM_DBG_USE_FUNC` `__FUNCTION__`
- #define `__ORSIM_GET_DEBUGGING_TRACE`(dbch) ((dbch)[0] & (1 << \_\_ORSIM\_DBCL\_TRACE))
- #define `__ORSIM_GET_DEBUGGING_WARN`(dbch) ((dbch)[0] & (1 << \_\_ORSIM\_DBCL\_WARN))
- #define `__ORSIM_GET_DEBUGGING_FIXME`(dbch) ((dbch)[0] & (1 << \_\_ORSIM\_DBCL\_FIXME))
- #define `__ORSIM_GET_DEBUGGING_ERR`(dbch) ((dbch)[0] & (1 << \_\_ORSIM\_DBCL\_ERR))
- #define `__ORSIM_GET_DEBUGGING`(dbcl, dbch) `__ORSIM_GET_DEBUGGING##dbcl`(dbch)
- #define `__ORSIM_DPRINTF`(dbcl, dbch)
- #define `__ORSIM_DEBUG_LOG`(args...) `orsim_dbg_log(__dbcl, __dbch, __ORSIM_DBG_USE_FUNC, args); } } while(0)`
- #define `TRACE`(ch) `__ORSIM_DPRINTF(_TRACE, __orsim_dbch_##ch)`
- #define `FIXME`(ch) `__ORSIM_DPRINTF(_FIXME, __orsim_dbch_##ch)`
- #define `WARN`(ch) `__ORSIM_DPRINTF(_WARN, __orsim_dbch_##ch)`
- #define `ERR`(ch) `__ORSIM_DPRINTF(_ERR, __orsim_dbch_##ch)`
- #define `TRACE` `__ORSIM_DPRINTF(_TRACE, __orsim_dbch__default)`
- #define `FIXME` `__ORSIM_DPRINTF(_FIXME, __orsim_dbch__default)`
- #define `WARN` `__ORSIM_DPRINTF(_WARN, __orsim_dbch__default)`
- #define `ERR` `__ORSIM_DPRINTF(_ERR, __orsim_dbch__default)`
- #define `TRACE_ON`(ch) `__ORSIM_GET_DEBUGGING(_TRACE, __orsim_dbch_##ch)`
- #define `WARN_ON`(ch) `__ORSIM_GET_DEBUGGING(_WARN, __orsim_dbch_##ch)`
- #define `FIXME_ON`(ch) `__ORSIM_GET_DEBUGGING(_FIXME, __orsim_dbch_##ch)`
- #define `ERR_ON`(ch) `__ORSIM_GET_DEBUGGING(_ERR, __orsim_dbch_##ch)`
- #define `DEFAULT_DEBUG_CHANNEL`(dbch)
- #define `DECLARE_DEBUG_CHANNEL`(dbch) `extern char __orsim_dbch_##dbch[ ];`

### Enumerations

- enum `__ORSIM_DEBUG_CLASS` { `__ORSIM_DBCL_TRACE`, `__ORSIM_DBCL_FIXME`, `__ORSIM_DBCL_WARN`, `__ORSIM_DBCL_ERR` }

### Functions

- void `orsim_dbg_log` (enum `__ORSIM_DEBUG_CLASS` dbcl, const char \*dbch, const char \*function, const char \*format,...) `__attribute__((format(printf`
- void `orsim_dbcl_set_name` (enum `__ORSIM_DEBUG_CLASS` dbcl, const char \*dbch, int on)
- void `parse_dbchs` (const char \*str)
- void `debug` (int level, const char \*format,...)

## 6.153.1 Define Documentation

6.153.1.1 **#define** `__ORSIM_DBG_USE_FUNC __FUNCTION__`

6.153.1.2 **#define** `__ORSIM_DEBUG_LOG(args...) orsim_dbg_log(__dbcl, __dbch, __ORSIM_DBG_USE_FUNC, args); } } while(0)`

6.153.1.3 **#define** `__ORSIM_DPRINTF(dbcl, dbch)`

### Value:

```
do { if(__ORSIM_GET_DEBUGGING(dbcl, (dbch))) { \
    const char * const __dbch = dbch; \
    const enum __ORSIM_DEBUG_CLASS __dbcl = __ORSIM_DBCL##dbcl; \
    __ORSIM_DEBUG_LOG
```

6.153.1.4 **#define** `__ORSIM_GET_DEBUGGING(dbcl, dbch) __ORSIM_GET_DEBUGGING##dbcl(dbch)`

6.153.1.5 **#define** `__ORSIM_GET_DEBUGGING_ERR(dbch) ((dbch)[0] & (1 << __ORSIM_DBCL_ERR))`

6.153.1.6 **#define** `__ORSIM_GET_DEBUGGING_FIXME(dbch) ((dbch)[0] & (1 << __ORSIM_DBCL_FIXME))`

6.153.1.7 **#define** `__ORSIM_GET_DEBUGGING_TRACE(dbch) ((dbch)[0] & (1 << __ORSIM_DBCL_TRACE))`

6.153.1.8 **#define** `__ORSIM_GET_DEBUGGING_WARN(dbch) ((dbch)[0] & (1 << __ORSIM_DBCL_WARN))`

6.153.1.9 **#define** `DECLARE_DEBUG_CHANNEL(dbch) extern char __orsim_dbch_##dbch[ ];`

6.153.1.10 **#define** `DEFAULT_DEBUG_CHANNEL(dbch)`

### Value:

```
extern char __orsim_dbch_##dbch[ ]; \
static char * const __orsim_dbch___default = __orsim_dbch_##dbch;
```

- 6.153.1.11 `#define ERR __ORSIM_DPRINTF(_ERR, __orsim_dbch__default)`
- 6.153.1.12 `#define ERR_(ch) __ORSIM_DPRINTF(_ERR, __orsim_dbch_##ch)`
- 6.153.1.13 `#define ERR_ON(ch) __ORSIM_GET_DEBUGGING(_ERR, __orsim_dbch_##ch)`
- 6.153.1.14 `#define FIXME __ORSIM_DPRINTF(_FIXME, __orsim_dbch__default)`
- 6.153.1.15 `#define FIXME_(ch) __ORSIM_DPRINTF(_FIXME, __orsim_dbch_##ch)`
- 6.153.1.16 `#define FIXME_ON(ch) __ORSIM_GET_DEBUGGING(_FIXME, __orsim_dbch_-##ch)`
- 6.153.1.17 `#define TRACE __ORSIM_DPRINTF(_TRACE, __orsim_dbch__default)`
- 6.153.1.18 `#define TRACE_(ch) __ORSIM_DPRINTF(_TRACE, __orsim_dbch_##ch)`
- 6.153.1.19 `#define TRACE_ON(ch) __ORSIM_GET_DEBUGGING(_TRACE, __orsim_dbch_-##ch)`
- 6.153.1.20 `#define WARN __ORSIM_DPRINTF(_WARN, __orsim_dbch__default)`
- 6.153.1.21 `#define WARN_(ch) __ORSIM_DPRINTF(_WARN, __orsim_dbch_##ch)`
- 6.153.1.22 `#define WARN_ON(ch) __ORSIM_GET_DEBUGGING(_WARN, __orsim_dbch_##ch)`

## 6.153.2 Enumeration Type Documentation

### 6.153.2.1 `enum __ORSIM_DEBUG_CLASS`

Enumerator:

`__ORSIM_DBCL_TRACE`

`__ORSIM_DBCL_FIXME`

`__ORSIM_DBCL_WARN`

`__ORSIM_DBCL_ERR`

## 6.153.3 Function Documentation

### 6.153.3.1 `void debug(int level, const char *format, ...)`

Internal debug function

Print the message if the level is greater than or equal to that specified in the configuration.

Parameters:

← *level* The debug level of this message

← *format* Varargs format string

← ... The varargs required by the string

**6.153.3.2** void void orsim\_dbcl\_set\_name (enum \_\_ORSIM\_DEBUG\_CLASS *dbcl*, const char \* *dbch*, int *on*)

Here is the call graph for this function:

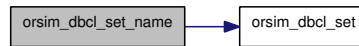

**6.153.3.3** void orsim\_dbg\_log (enum \_\_ORSIM\_DEBUG\_CLASS *dbcl*, const char \* *dbch*, const char \* *function*, const char \* *format*, ...)

**6.153.3.4** void parse\_dbchs (const char \* *str*)

Here is the call graph for this function:





## 6.154 support/dumpverilog.c File Reference

```
#include "config.h"
#include "sim-config.h"
#include "arch.h"
#include "abstract.h"
#include "labels.h"
#include "opcode/or32.h"
```

Include dependency graph for dumpverilog.c:

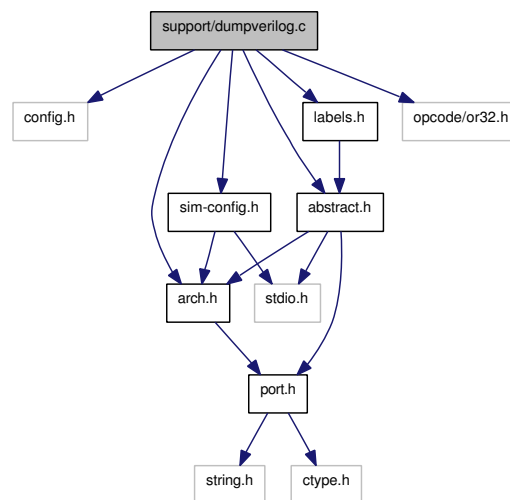

### Defines

- #define [DW](#) 32
- #define [DWQ](#) (DW/8)
- #define [DISWIDTH](#) 25
- #define [OR1K\\_MEM\\_VERILOG\\_HEADER](#)(MODNAME, FROMADDR, TOADDR, DISWIDTH)
- #define [OR1K\\_MEM\\_VERILOG\\_FOOTER](#) "\n\nend\n\nalways @(posedge clk) begin\n\n if (ce && ~we) begin\n\n dataout <= #1 mem[addr];\n\n disout <= #1 dis[addr];\n\n \$display(\"or1k\_mem: reading mem[%0d]:%0h dis: %0s\", addr, dataout, dis[addr]);\n\n end else\n\n if (ce && we) begin\n\n mem[addr] <= #1 data;\n\n dis[addr] <= #1 \"(data)\";\n\n \$display(\"or1k\_mem: writing mem[%0d]:%0h dis: %0s\", addr, mem[addr], dis[addr]);\n\n end\n\nend\n\nendmodule\n"
- #define [LABLEND\\_CHAR](#) ":"

### Functions

- void [dumpverilog](#) (char \*verilog\_modname, [oraddr\\_t](#) from, [oraddr\\_t](#) to)
- void [dumphex](#) ([oraddr\\_t](#) from, [oraddr\\_t](#) to)

## 6.154.1 Define Documentation

6.154.1.1 **#define DISWIDTH 25**

6.154.1.2 **#define DW 32**

6.154.1.3 **#define DWQ (DW/8)**

6.154.1.4 **#define LABELEND\_CHAR ""**

6.154.1.5 **#define OR1K\_MEM\_VERILOG\_FOOTER ""**  
`\n\end\n\nalways @(posedge clk)  
begin\n\n if (ce && ~we) begin\n\n dataout <= #1 mem[addr];\n\n disout <= #1  
dis[addr];\n\n $display(\"or1k_mem: reading mem[%0d]:%0h dis: %0s\", addr,  
dataout, dis[addr]);\n\n end else\n\n if (ce && we) begin\n\n mem[addr] <= #1 data;\n\n  
dis[addr] <= #1 \"(data)\";\n\n $display(\"or1k_mem: writing mem[%0d]:%0h  
dis: %0s\", addr, mem[addr], dis[addr]);\n\n end\n\nend\n\nendmodule\n"`

6.154.1.6 **#define OR1K\_MEM\_VERILOG\_HEADER(MODNAME, FROMADDR, TOADDR,  
DISWIDTH)**

**Value:**

```

"\n\n\
#include \"general.h\"\n\n\n\
`timescale 1ns/100ps\n\n\n\
// Simple dw-wide Sync SRAM with initial content generated by orlksim.\n\n\
// All control, data in and addr signals are sampled at rising clock edge \n\n\
// Data out is not registered. Address bits specify dw-word (narrowest \n\n\
// addressed data is not byte but dw-word !). \n\n\
// There are still some bugs in generated output (dump word aligned regions)\n\n\n\
module %s(clk, data, addr, ce, we, disout);\n\n\n\
parameter dw = 32;\n\n\n\
parameter amin = % PRIdREG "; \n\n\n\
parameter amax = % PRIdREG "; \n\n\n\
input clk;\n\n\n\
inout [dw-1:0] data;\n\n\n\
input [31:0] addr;\n\n\n\
input ce;\n\n\n\
input we;\n\n\n\
output [%d:0] disout;\n\n\n\
reg [%d:0] disout;\n\n\n\
reg [dw-1:0] mem [amax:amin];\n\n\n\
reg [%d:0] dis [amax:amin];\n\n\n\
reg [dw-1:0] dataout;\n\n\n\
tri [dw-1:0] data = (ce && ~we) ? dataout : 'bz;\n\n\n\
initial begin\n\n", MODNAME, FROMADDR, TOADDR, DISWIDTH-1, DISWIDTH-1, DISWIDTH-1

```

## 6.154.2 Function Documentation

### 6.154.2.1 void dumphex (oraddr\_t from, oraddr\_t to)

Here is the call graph for this function:

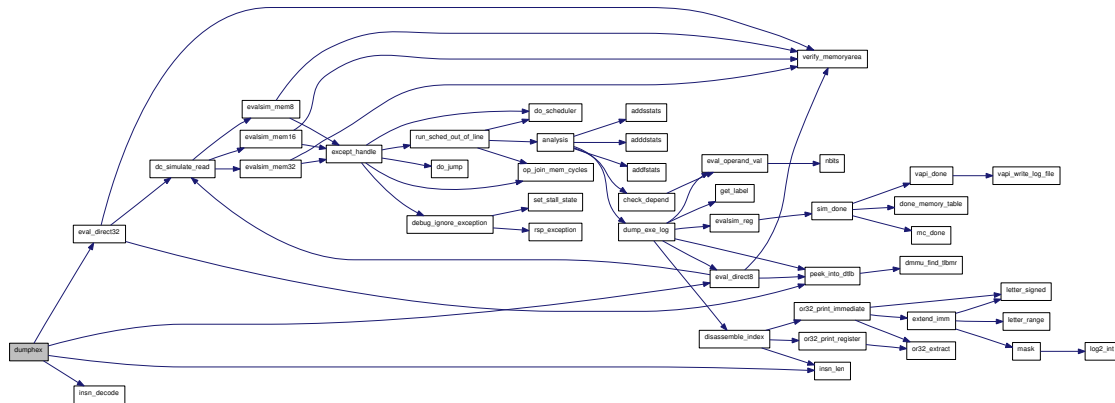

### 6.154.2.2 void dumpverilog (char \* verilog\_modname, oraddr\_t from, oraddr\_t to)

Here is the call graph for this function:

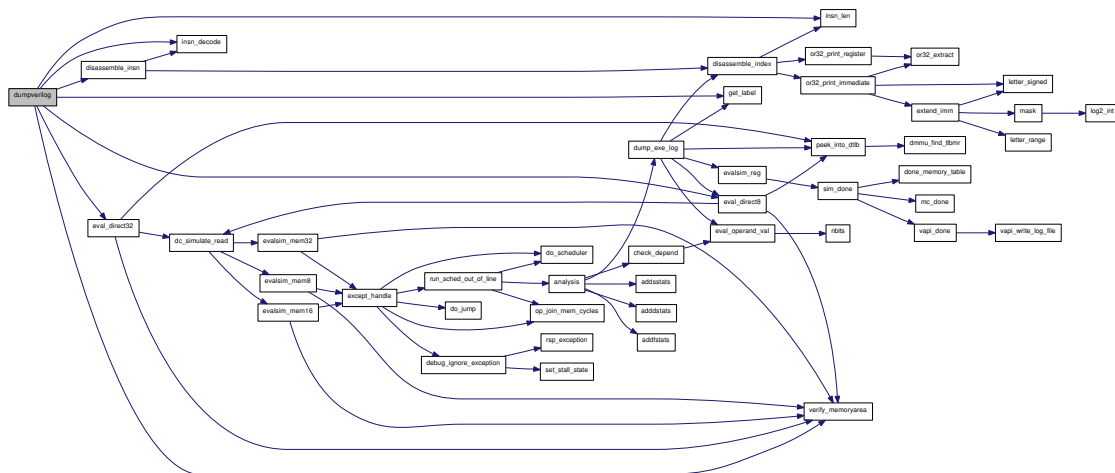

## 6.155 support/dumpverilog.h File Reference

```
#include "arch.h"
```

Include dependency graph for dumpverilog.h:

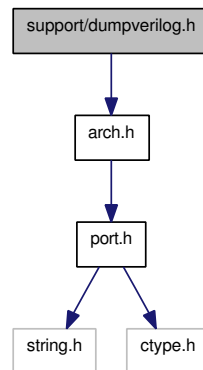

This graph shows which files directly or indirectly include this file:

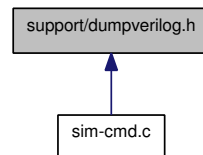

## Functions

- void `dumpverilog` (char \*verilog\_modname, `oraddr_t` from, `oraddr_t` to)
- void `dumphex` (`oraddr_t` from, `oraddr_t` to)



## 6.156 support/misc.c File Reference

```
#include "config.h"
```

Include dependency graph for misc.c:

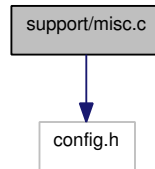

### Functions

- [int log2\\_int](#) (unsigned long *x*)
- [int is\\_power2](#) (int *x*)

### 6.156.1 Function Documentation

**6.156.1.1** [int is\\_power2](#) (int *x*)

**6.156.1.2** [int log2\\_int](#) (unsigned long *x*)

## 6.157 support/misc.h File Reference

This graph shows which files directly or indirectly include this file:

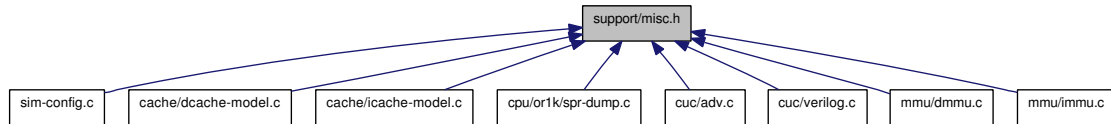

### Functions

- [int log2\\_int](#) (unsigned long *x*)
- [int is\\_power2](#) (int *x*)

### 6.157.1 Function Documentation

#### 6.157.1.1 [int is\\_power2](#) (int *x*)

#### 6.157.1.2 [int log2\\_int](#) (unsigned long *x*)

## 6.158 support/profile.c File Reference

```
#include "config.h"  
#include <stdio.h>  
#include "profile.h"  
#include "sim-config.h"  
#include "arch.h"
```

Include dependency graph for profile.c:

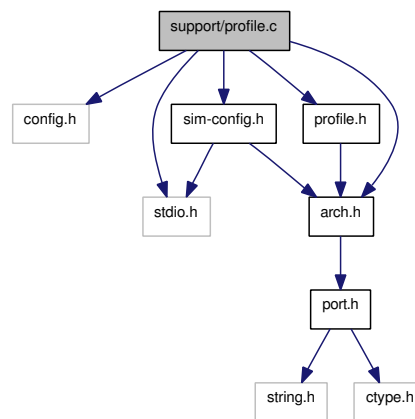

### Functions

- void `mprofile` (`oraddr_t memaddr`, unsigned char type)

#### 6.158.1 Function Documentation

**6.158.1.1** void `mprofile` (`oraddr_t memaddr`, unsigned char type)



## 6.159 support/profile.h File Reference

```
#include "arch.h"
```

Include dependency graph for profile.h:

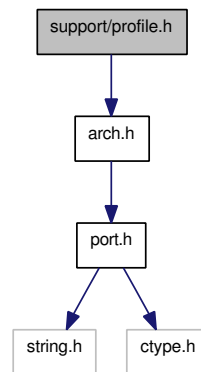

This graph shows which files directly or indirectly include this file:

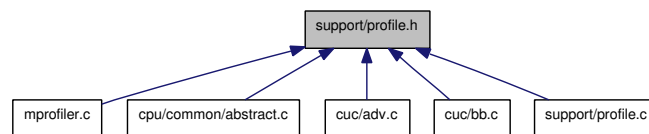

### Data Structures

- struct [mprofentry\\_struct](#)

### Defines

- #define [MPROF\\_READ](#) 1
- #define [MPROF\\_WRITE](#) 2
- #define [MPROF\\_FETCH](#) 4
- #define [MPROF\\_8](#) 8
- #define [MPROF\\_16](#) 16
- #define [MPROF\\_32](#) 32

### Functions

- void [mprofile](#) ([oraddr\\_t](#) memaddr, unsigned char type)

### 6.159.1 Define Documentation

6.159.1.1 `#define MPROF_16 16`

6.159.1.2 `#define MPROF_32 32`

6.159.1.3 `#define MPROF_8 8`

6.159.1.4 `#define MPROF_FETCH 4`

6.159.1.5 `#define MPROF_READ 1`

6.159.1.6 `#define MPROF_WRITE 2`

### 6.159.2 Function Documentation

6.159.2.1 `void mprofile (oraddr_t memaddr, unsigned char type)`

## 6.160 support/sched.c File Reference

```
#include "config.h"
#include "port.h"
#include <stdlib.h>
#include <stdio.h>
#include <limits.h>
#include "sched.h"
#include "debug.h"
#include "sim-config.h"
```

Include dependency graph for sched.c:

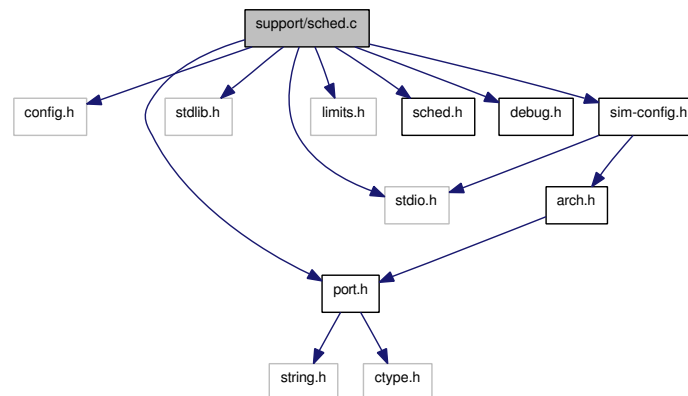

### Defines

- `#define SCHED_HEAP_SIZE 128`
- `#define SCHED_TIME_MAX INT32_MAX`

### Functions

- `DECLARE_DEBUG_CHANNEL` (sched\_jobs)
- void `sched_guard` (void \*dat)
- void `sched_reset` (void)
- void `sched_init` (void)
- void `do_scheduler` (void)
- void `sched_add` (void(\*job\_func)(void \*), void \*job\_param, int32\_t job\_time, const char \*func)
- void `sched_find_remove` (void(\*job\_func)(void \*), void \*dat)
- void `sched_next_insn` (void(\*func)(void \*), void \*dat)

### Variables

- struct `scheduler_struct scheduler`

## 6.160.1 Define Documentation

6.160.1.1 `#define SCHED_HEAP_SIZE 128`

6.160.1.2 `#define SCHED_TIME_MAX INT32_MAX`

## 6.160.2 Function Documentation

6.160.2.1 `DECLARE_DEBUG_CHANNEL (sched_jobs)`

6.160.2.2 `void do_scheduler (void)`

6.160.2.3 `void sched_add (void(*) (void *) job_func, void * job_param, int32_t job_time, const char * func)`

6.160.2.4 `void sched_find_remove (void(*) (void *) job_func, void * dat)`

6.160.2.5 `void sched_guard (void * dat)`

6.160.2.6 `void sched_init (void)`

Here is the call graph for this function:



6.160.2.7 `void sched_next_insn (void(*) (void *) func, void * dat)`

6.160.2.8 `void sched_reset (void)`

Here is the call graph for this function:



## 6.160.3 Variable Documentation

6.160.3.1 `struct scheduler_struct scheduler`

## 6.161 support/sched.h File Reference

This graph shows which files directly or indirectly include this file:

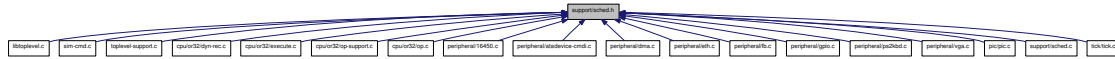

### Data Structures

- struct [sched\\_entry](#)
- struct [scheduler\\_struct](#)

### Defines

- #define [SCHED\\_ADD](#)(job\_func, job\_param, job\_time) sched\_add(job\_func, job\_param, job\_time, #job\_func)
- #define [SCHED\\_FIND\\_REMOVE](#)(f, p) sched\_find\_remove(f, p)

### Functions

- void [sched\\_init](#) ()
- void [sched\\_reset](#) ()
- void [sched\\_next\\_insn](#) (void(\*func)(void \*), void \*dat)
- void [sched\\_find\\_remove](#) (void(\*job\_func)(void \*), void \*dat)
- void [sched\\_add](#) (void(\*job\_func)(void \*), void \*job\_param, int32\_t job\_time, const char \*func)
- void [do\\_scheduler](#) ()

### Variables

- struct [scheduler\\_struct](#) [scheduler](#)

#### 6.161.1 Define Documentation

**6.161.1.1** #define [SCHED\\_ADD](#)(job\_func, job\_param, job\_time) sched\_add(job\_func, job\_param, job\_time, #job\_func)

Macro to add a job to the scheduler

**6.161.1.2** #define [SCHED\\_FIND\\_REMOVE](#)(f, p) sched\_find\_remove(f, p)

Macro to remove a job from the scheduler

## 6.161.2 Function Documentation

6.161.2.1 void do\_scheduler ()

6.161.2.2 void sched\_add (void(\*) (void \*) *job\_func*, void \* *job\_param*, int32\_t *job\_time*, const char \* *func*)

6.161.2.3 void sched\_find\_remove (void(\*) (void \*) *job\_func*, void \* *dat*)

6.161.2.4 void sched\_init ()

Here is the call graph for this function:



6.161.2.5 void sched\_next\_insn (void(\*) (void \*) *func*, void \* *dat*)

6.161.2.6 void sched\_reset ()

Here is the call graph for this function:



## 6.161.3 Variable Documentation

6.161.3.1 struct scheduler\_struct scheduler

## 6.162 support/simprintf.c File Reference

```
#include "config.h"
#include "port.h"
#include <stdlib.h>
#include "sim-config.h"
#include "arch.h"
#include "debug.h"
#include "abstract.h"
#include "execute.h"
```

Include dependency graph for simprintf.c:

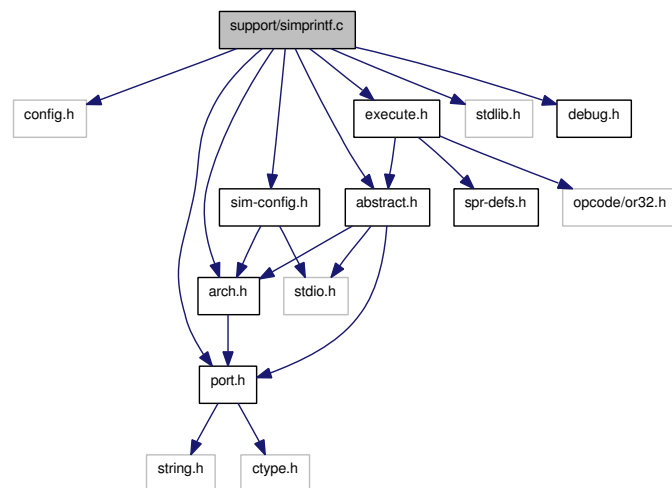

### Defines

- #define [STACK\\_ARGS](#) 0
- #define [FMTLEN](#) 2000

### Functions

- static char \* [simgetstr](#) ([oraddr\\_t](#) stackaddr, unsigned long regparam)
- void [simprintf](#) ([oraddr\\_t](#) stackaddr, unsigned long regparam)

### Variables

- char [fmtstr](#) [[FMTLEN](#)]

## 6.162.1 Define Documentation

### 6.162.1.1 #define FMTLEN 2000

### 6.162.1.2 #define STACK\_ARGS 0

## 6.162.2 Function Documentation

### 6.162.2.1 static char\* simgetstr (oraddr\_t stackaddr, unsigned long regparam) [static]

Here is the call graph for this function:

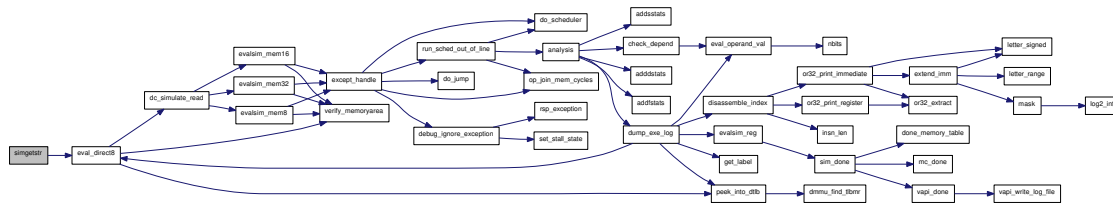

### 6.162.2.2 void simprintf (oraddr\_t stackaddr, unsigned long regparam)

Here is the call graph for this function:

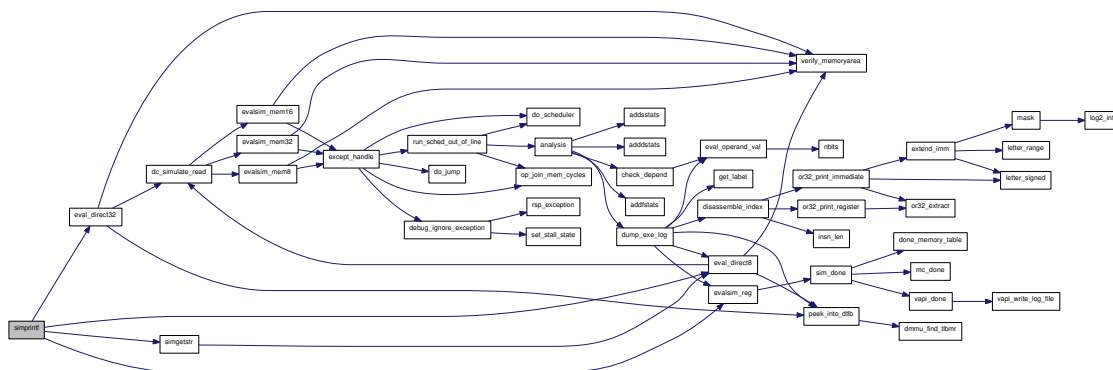

## 6.162.3 Variable Documentation

### 6.162.3.1 char fmtstr[FMTLEN]



## 6.163 support/simprintf.h File Reference

```
#include "arch.h"
```

Include dependency graph for simprintf.h:

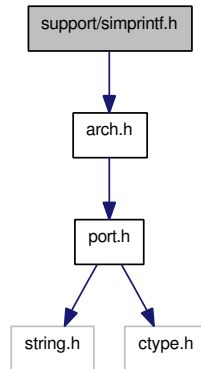

This graph shows which files directly or indirectly include this file:

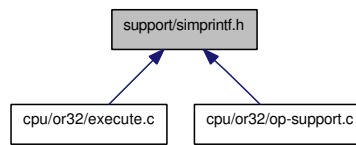

## Functions

- void `simprintf` (`oraddr_t` stackaddr, unsigned long regparam)

### 6.163.1 Function Documentation

#### 6.163.1.1 void `simprintf` (`oraddr_t` stackaddr, unsigned long regparam)

Here is the call graph for this function:

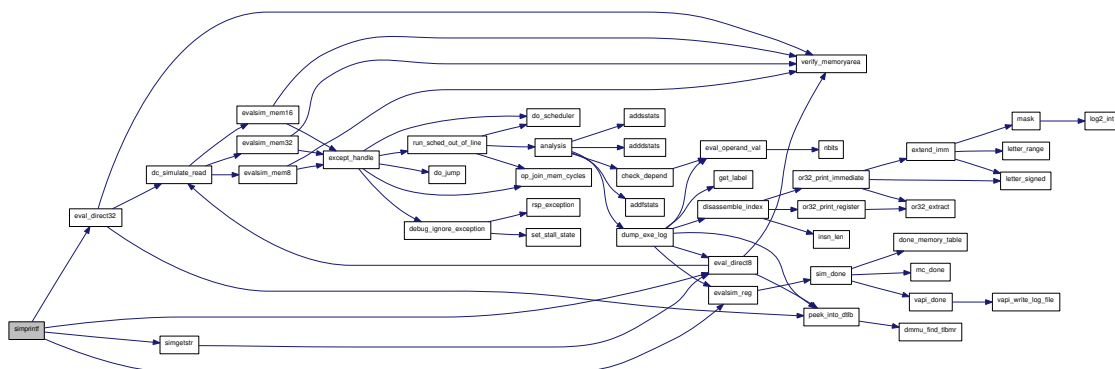

## 6.164 tick/tick.c File Reference

```
#include "config.h"
#include "port.h"
#include <stdlib.h>
#include <stdio.h>
#include "arch.h"
#include "abstract.h"
#include "except.h"
#include "tick.h"
#include "opcode/or32.h"
#include "spr-defs.h"
#include "execute.h"
#include "pic.h"
#include "sprs.h"
#include "sim-config.h"
#include "sched.h"
```

Include dependency graph for tick.c:

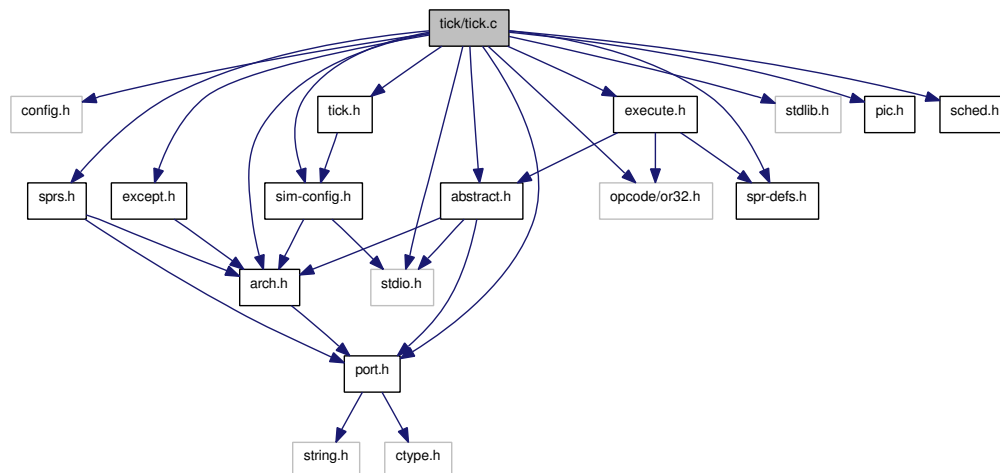

## Functions

- void [tick\\_reset](#) (void)
- static void [tick\\_raise\\_except](#) (void \*dat)
- static void [tick\\_restart](#) (void \*dat)
- static void [tick\\_one\\_shot](#) (void \*dat)
- static void [sched\\_timer\\_job](#) (uorreg\_t prev\_ttmr)
- void [spr\\_write\\_ttc](#) (uorreg\_t value)
- void [spr\\_write\\_ttmr](#) (uorreg\_t prev\_val)

- `uorreg_t spr_read_ttr ()`

## Variables

- static long long `cycles_start = 0`
- int `tick_count`

## 6.164.1 Function Documentation

### 6.164.1.1 static void sched\_timer\_job (uorreg\_t prev\_ttr) [static]

Schedules the timer jobs

Here is the call graph for this function:

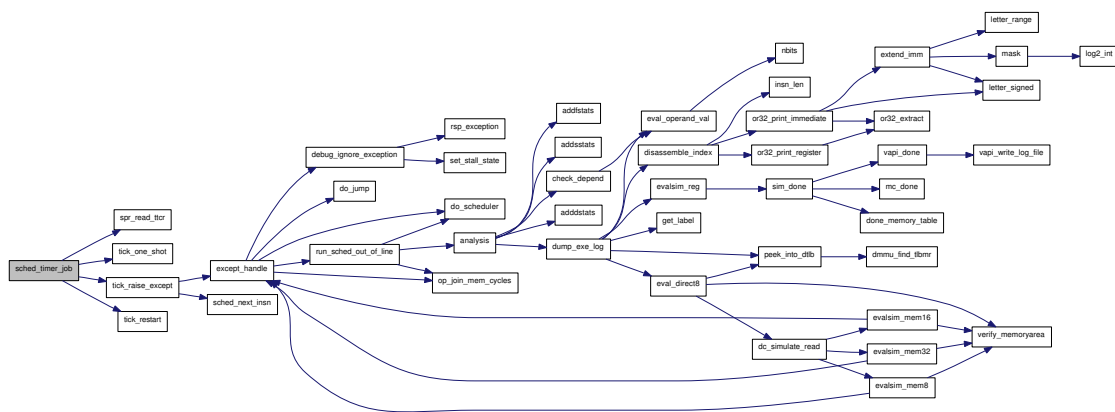

### 6.164.1.2 uorreg\_t spr\_read\_ttr ()

### 6.164.1.3 void spr\_write\_ttr (uorreg\_t value)

Handles a write to the ttr spr

Here is the call graph for this function:

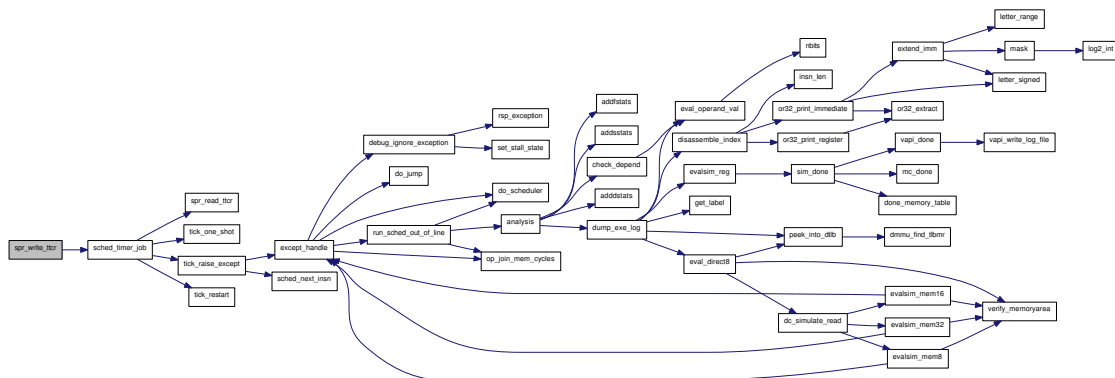

### 6.164.1.4 void spr\_write\_ttmr (uorreg\_t prev\_val)

Value is the \*previous\* value of SPR\_TTMR. The new one can be found in `cpu_state.sprs[SPR_TTMR]`

Here is the call graph for this function:

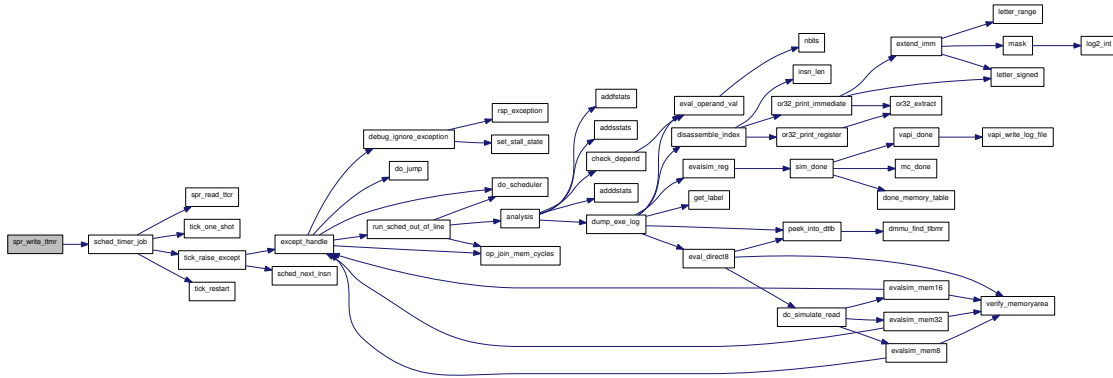

### 6.164.1.5 static void tick\_one\_shot (void \* dat) [static]

Stops the timer

### 6.164.1.6 static void tick\_raise\_except (void \* dat) [static]

Raises a timer exception

Here is the call graph for this function:

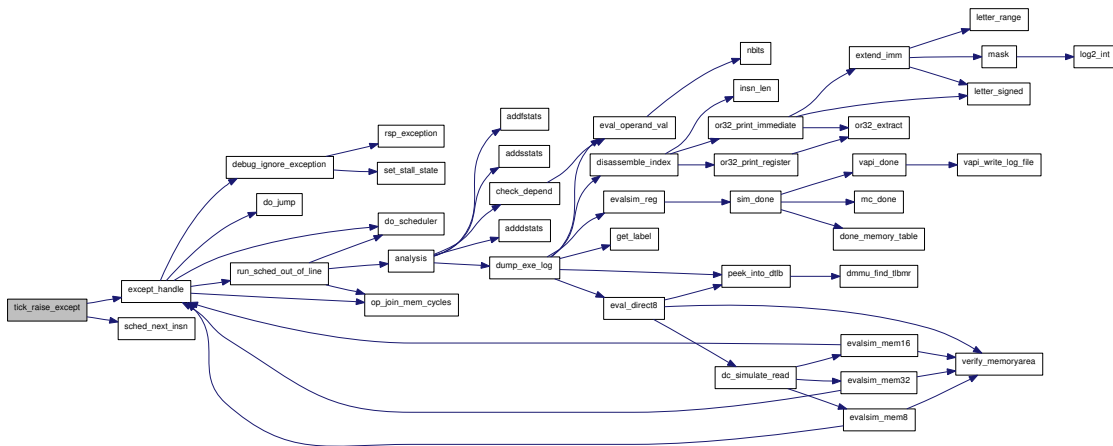

### 6.164.1.7 void tick\_reset (void)

Reset. It initializes TTCR register.

**6.164.1.8 static void tick\_restart (void \* *dat*) [static]**

Restarts the tick timer

**6.164.2 Variable Documentation****6.164.2.1 long long cycles\_start = 0 [static]**

When did the timer start to count

**6.164.2.2 int tick\_count**

Indicates if the timer is actually counting. Needed to simulate one-shot mode correctly

## 6.165 tick/tick.h File Reference

```
#include "sim-config.h"
```

Include dependency graph for tick.h:

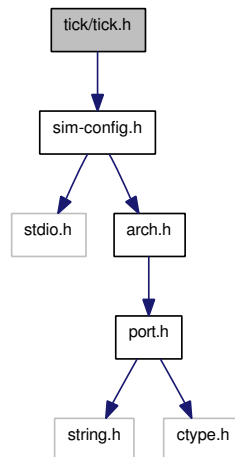

This graph shows which files directly or indirectly include this file:

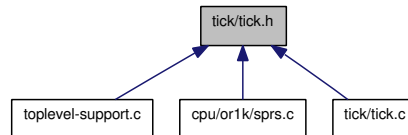

## Functions

- void [tick\\_reset \(\)](#)
- void [spr\\_write\\_ttc](#) ([uorreg\\_t value](#))
- void [spr\\_write\\_ttmr](#) ([uorreg\\_t value](#))
- [uorreg\\_t spr\\_read\\_ttc](#) ()

### 6.165.1 Function Documentation

#### 6.165.1.1 uorreg\_t spr\_read\_ttc ()

#### 6.165.1.2 void spr\_write\_ttc (uorreg\_t value)

Handles a write to the ttc spr

Here is the call graph for this function:

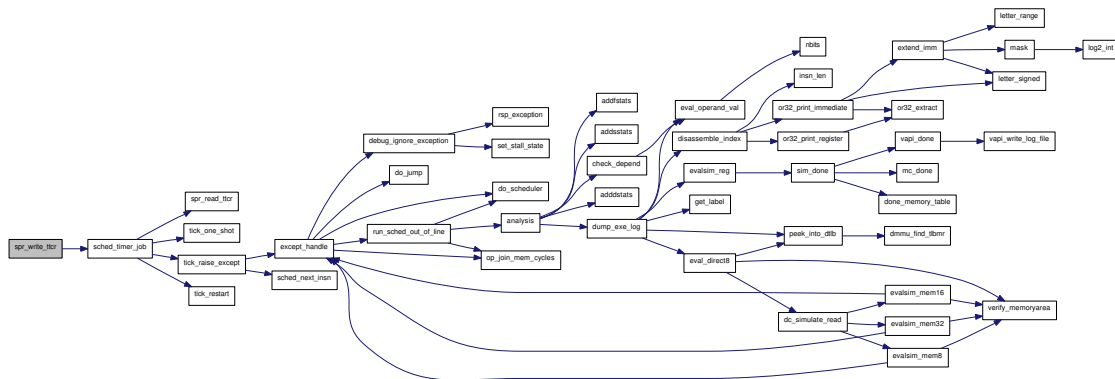

### 6.165.1.3 void spr\_write\_tmr (uorreg\_t prev\_val)

Value is the \*previous\* value of SPR\_TTMR. The new one can be found in `cpu_state.sprs[SPR_TTMR]`

Here is the call graph for this function:

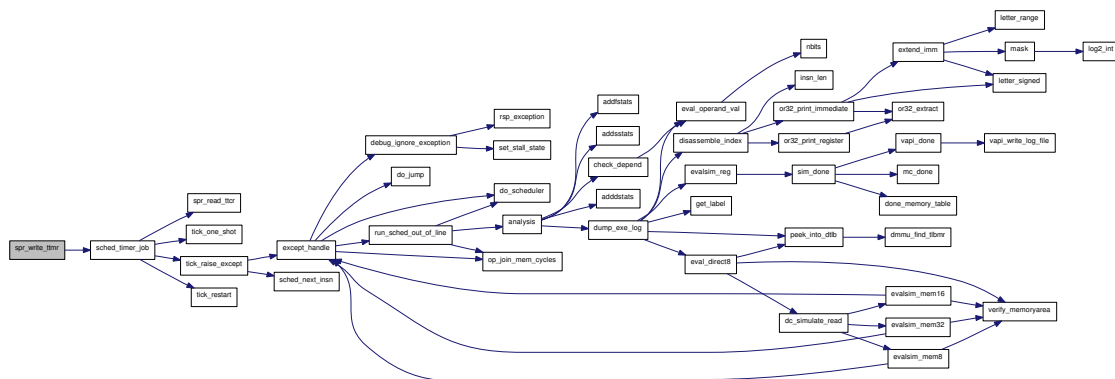

### 6.165.1.4 void tick\_reset (void)

Reset. It initializes TTCR register.

## 6.166 toplevel-mprofile.c File Reference

```
#include "config.h"  
#include <stdlib.h>  
#include <sys/types.h>  
#include <unistd.h>  
#include "sim-config.h"  
#include "mprofiler.h"
```

Include dependency graph for toplevel-mprofile.c:

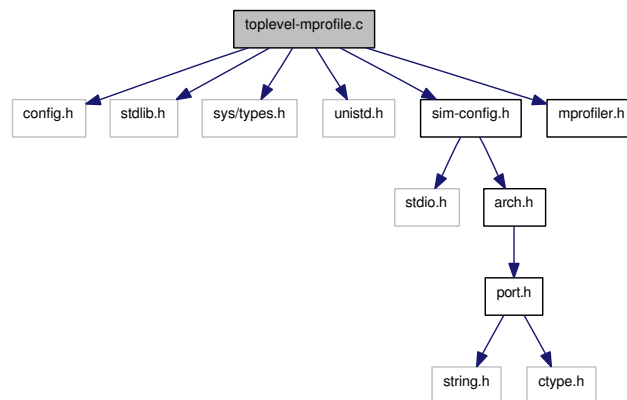

## Functions

- `int main (int argc, char *argv[ ])`





## 6.166.1 Function Documentation

### 6.166.1.1 `int main (int argc, char * argv[ ])`

Here is the call graph for this function:

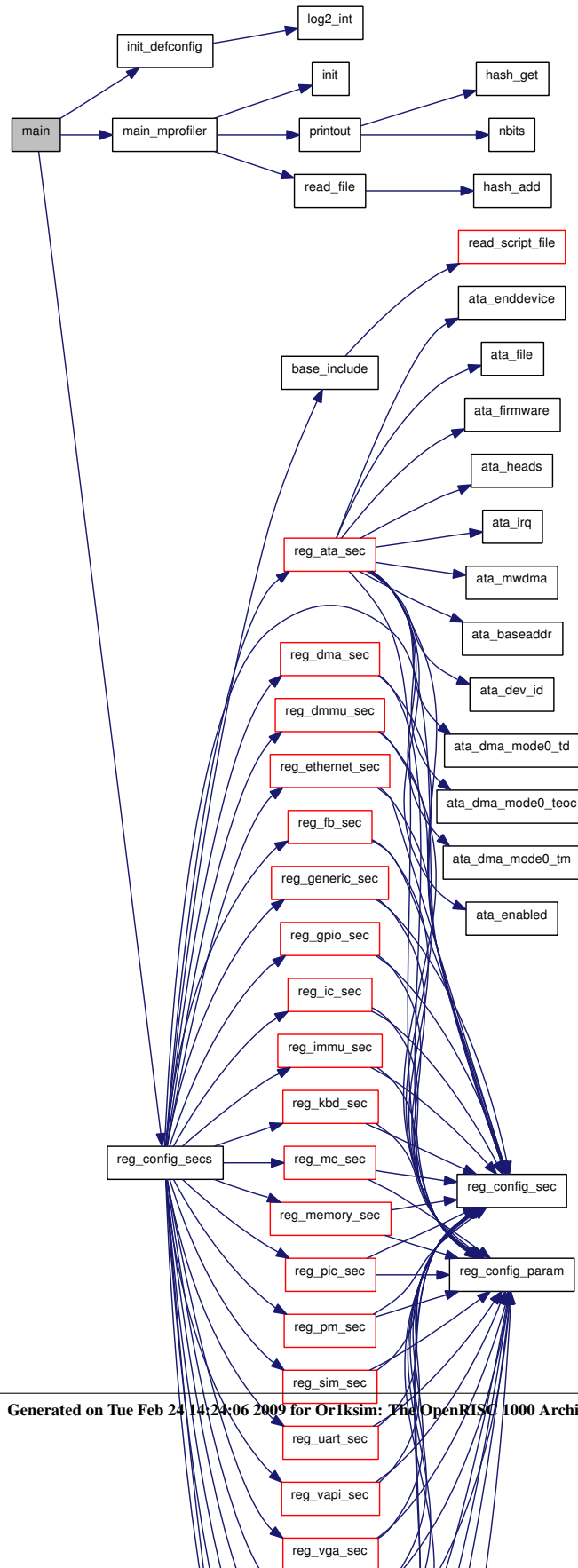

## 6.167 toplevel-profile.c File Reference

```
#include "config.h"  
#include <stdlib.h>  
#include <sys/types.h>  
#include <unistd.h>  
#include "sim-config.h"  
#include "profiler.h"
```

Include dependency graph for toplevel-profile.c:

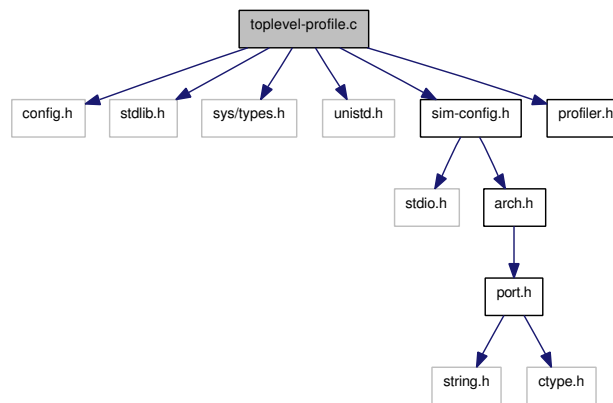

## Functions

- `int main (int argc, char *argv[ ])`



## 6.167.1 Function Documentation

### 6.167.1.1 int main (int argc, char \* argv[ ])

Here is the call graph for this function:

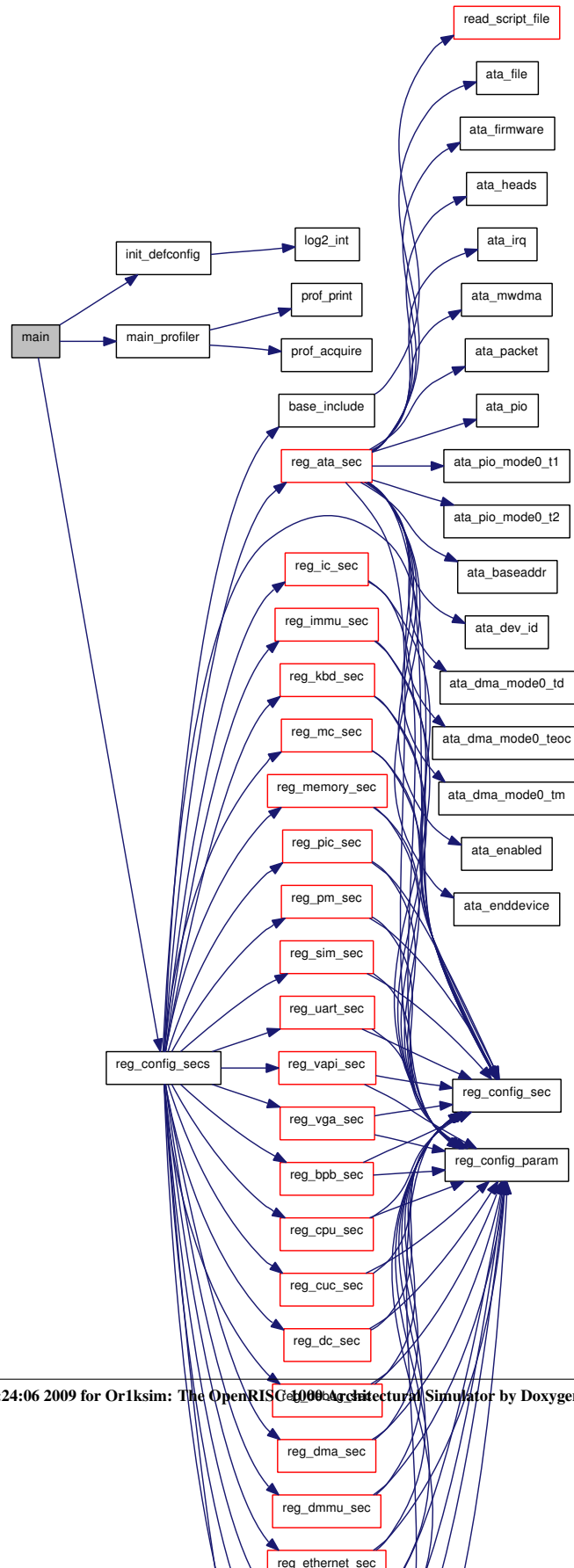

## 6.168 toplevel-support.c File Reference

```
#include "config.h"
#include <stdlib.h>
#include <unistd.h>
#include <stdarg.h>
#include <stdio.h>
#include <errno.h>
#include <signal.h>
#include "toplevel-support.h"
#include "sim-config.h"
#include "debug-unit.h"
#include "sim-cmd.h"
#include "sched.h"
#include "tick.h"
#include "pm.h"
#include "pic.h"
#include "execute.h"
#include "labels.h"
#include "stats.h"
#include "opcode/or32.h"
#include "parse.h"
#include "gdbcomm.h"
#include "rsp-server.h"
#include "vapi.h"
#include "abstract.h"
#include "mc.h"
#include "except.h"
```

Include dependency graph for toplevel-support.c:

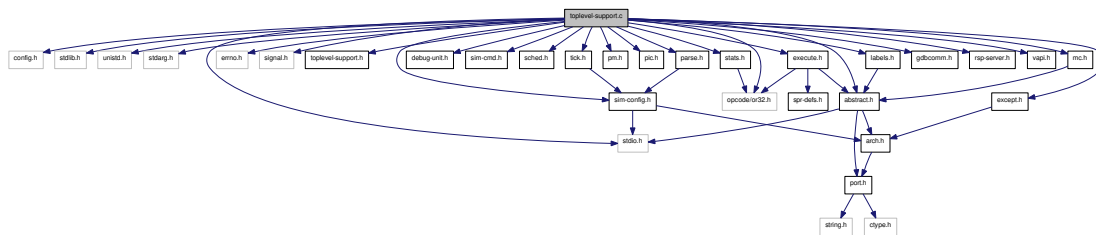

## Data Structures

- struct [sim\\_reset\\_hook](#)

## Functions

- void [ctrl\\_c](#) (int signum)
- void [check\\_int](#) (void \*dat)
- void [reg\\_sim\\_reset](#) (void(\*reset\_hook)(void \*), void \*dat)
- void [sim\\_reset](#) ()
- void [sim\\_init](#) ()
- void [sim\\_done](#) ()

## Variables

- static struct [sim\\_reset\\_hook](#) \* [sim\\_reset\\_hooks](#) = NULL

### 6.168.1 Function Documentation

#### 6.168.1.1 void [check\\_int](#) (void \* *dat*)

Routine poll to see if interaction is needed

This is most likely to happen due to a ctrl-C. However when the -i flag is specified, the simulator starts up ready for interaction.

The main simulator loop will stop for interaction if it hits a breakpoint.

#### Parameters:

- ← *dat* Data passed in by the Or1ksim scheduler. Not needed by this function.

Here is the call graph for this function:

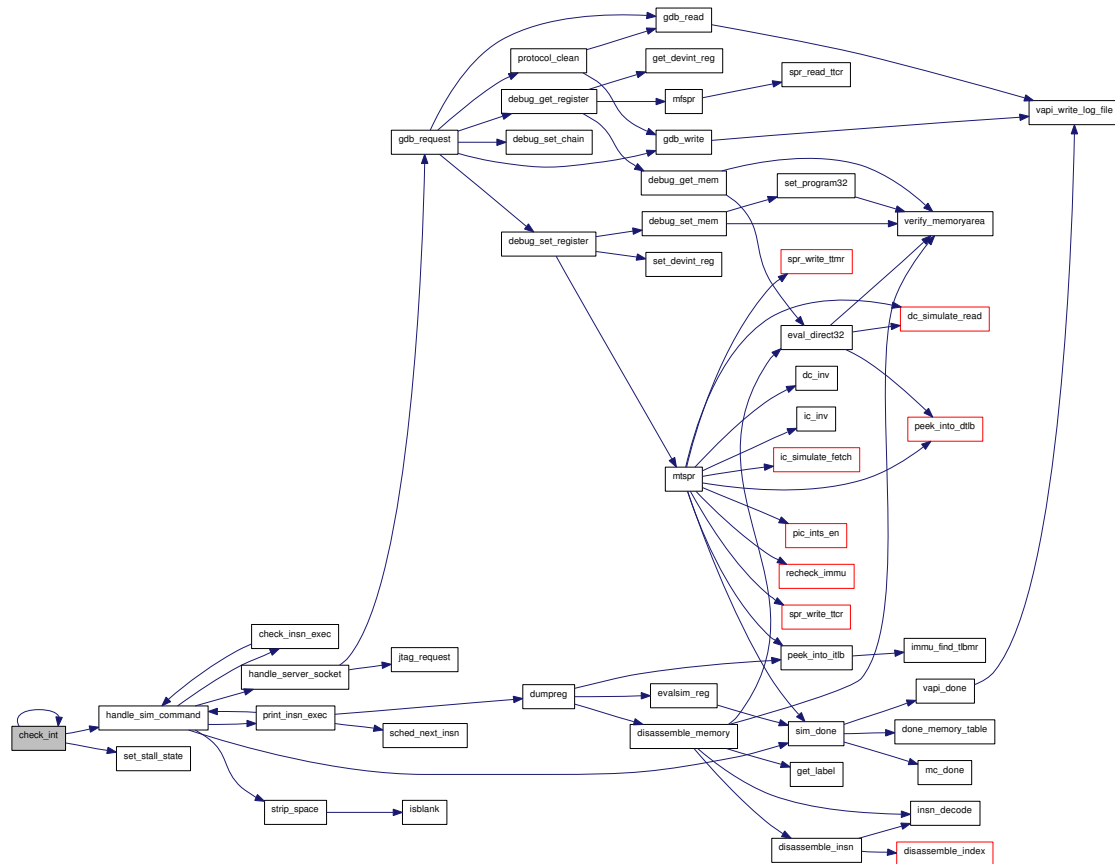

### 6.168.1.2 void ctrl\_c(int *sigum*)

Signal handler for ctrl-C

Sets the iprompt flag, so the simulator will stop next time round the loop. If the iprompt flag is set when we enter here, that means the simulator has not reacted since the last ctrl-C, so we kill the simulation.

#### Parameters:

← *sigum* The signal which triggered this handler

Here is the call graph for this function:

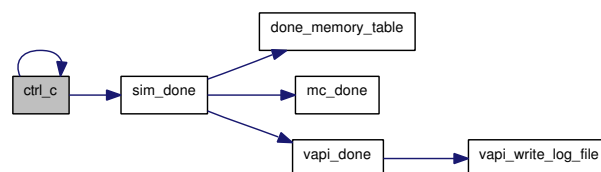



### 6.168.1.3 void reg\_sim\_reset (void(\*) (void \*) reset\_hook, void \* dat)

Register a new reset hook

The registered functions will be called in turn, whenever the simulation is reset by calling [sim\\_reset\(\)](#).

#### Parameters:

← *reset\_hook* The function to be called on reset

← *dat* The data structure to be passed as argument when the reset\_hook function is called.

### 6.168.1.4 void sim\_done ()

Clean up

Close an profile or log files, disconnect VAPI. Call any memory mapped peripheral close down function. Exit with rc 0.

Here is the call graph for this function:

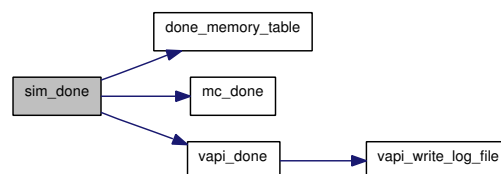

### 6.168.1.5 void sim\_init ()

Initialize the simulator

Reset internal data: symbol table (aka labels), breakpoints and stats. Rebuild the FSA's used for disassembly.

Initialize the [dynamic](#) execution system if required.

Initialize the scheduler.

Open the various logs and statistics files requested by the configuration and/or command arguments.

Initialize GDB and VAPI connections.

Reset the simulator.

Wait for VAPI to connect if configured.

Here is the call graph for this function:

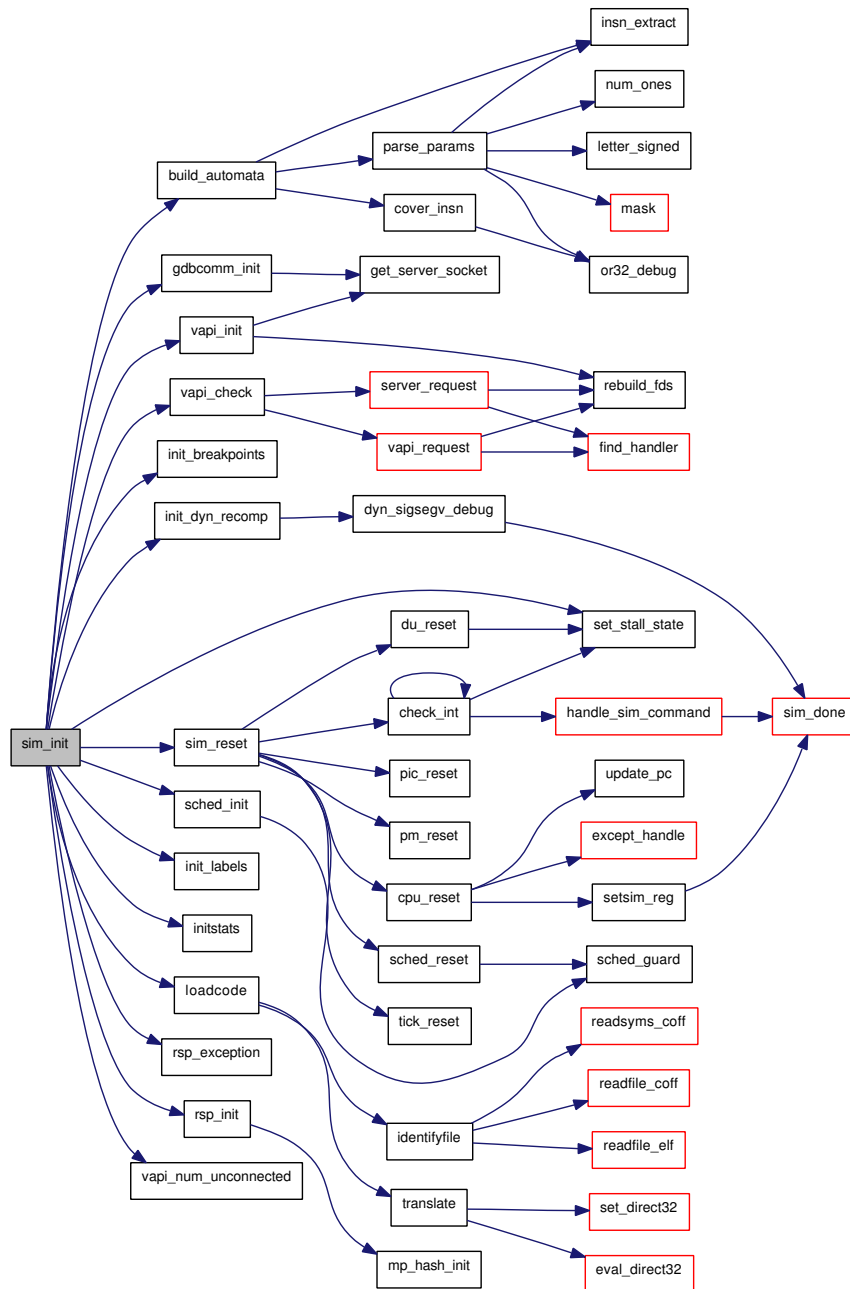

### 6.168.1.6 void sim\_reset ()

Reset the simulator

The scheduler is reset, then all reset functions on the reset hook list (i.e. peripherals) are reset. Then standard core functions (which do not use reset hooks) are reset: tick timer, power management, programmable interrupt controller and debug unit.

The scheduler queue is reinitialized with an immediate check for ctrl-C on its queue.

Finally the count of simulated cycles is set to zero, and the CPU itself is reset.

Here is the call graph for this function:

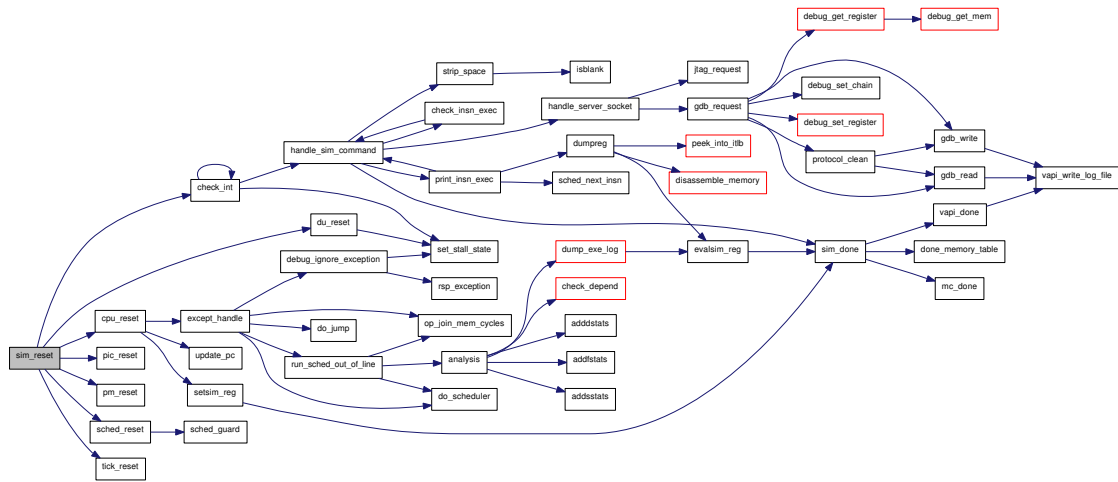

## 6.168.2 Variable Documentation

**6.168.2.1** `struct sim_reset_hook* sim_reset_hooks = NULL` [static]

The list of reset hooks. Local to this source file

## 6.169 toplevel-support.h File Reference

This graph shows which files directly or indirectly include this file:



### Functions

- void [ctrl\\_c](#) (int signum)
- void [reg\\_sim\\_reset](#) (void(\*reset\_hook)(void \*), void \*dat)
- void [sim\\_done](#) ()
- void [check\\_int](#) (void \*dat)
- void [sim\\_reset](#) ()
- void [sim\\_init](#) ()

### 6.169.1 Function Documentation

#### 6.169.1.1 void [check\\_int](#) (void \* *dat*)

Routine poll to see if interaction is needed

This is most likely to happen due to a ctrl-C. However when the `-i` flag is specified, the simulator starts up ready for interaction.

The main simulator loop will stop for interaction if it hits a breakpoint.

#### Parameters:

- ← *dat* Data passed in by the Or1ksim scheduler. Not needed by this function.

Here is the call graph for this function:

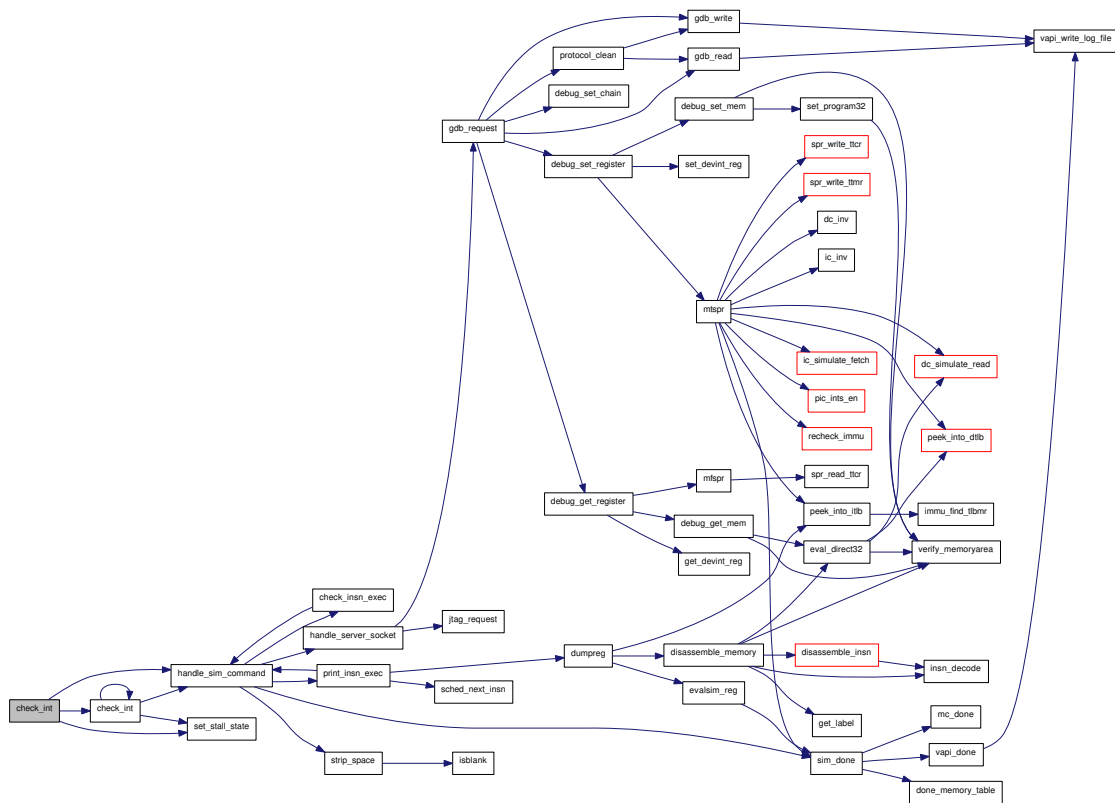

### 6.169.1.2 void ctrl\_c(int signum)

Signal handler for ctrl-C

Sets the iprompt flag, so the simulator will stop next time round the loop. If the iprompt flag is set when we enter here, that means the simulator has not reacted since the last ctrl-C, so we kill the simulation.

**Parameters:**

← *signum* The signal which triggered this handler

Here is the call graph for this function:

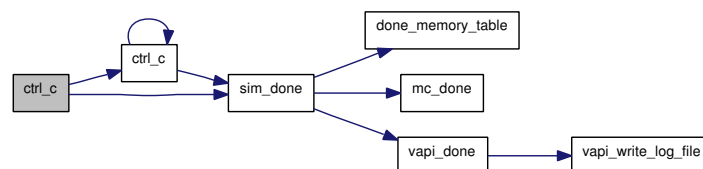

### 6.169.1.3 void reg\_sim\_reset(void(\*) (void \*) reset\_hook, void \* dat)

Register a new reset hook

The registered functions will be called in turn, whenever the simulation is reset by calling `sim_reset()`.

**Parameters:**

← *reset\_hook* The function to be called on reset

← *dat* The data structure to be passed as argument when the `reset_hook` function is called.

**6.169.1.4 void sim\_done ()**

Clean up

Close an profile or log files, disconnect VAPI. Call any memory mapped peripheral close down function. Exit with rc 0.

Here is the call graph for this function:

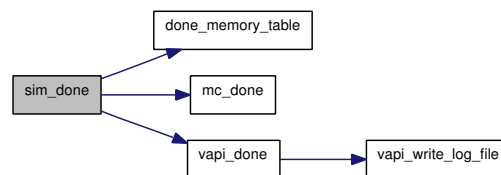

**6.169.1.5 void sim\_init ()**

Initialize the simulator

Reset internal data: symbol table (aka labels), breakpoints and stats. Rebuild the FSA's used for disassembly.

Initialize the [dynamic](#) execution system if required.

Initialize the scheduler.

Open the various logs and statistics files requested by the configuration and/or command arguments.

Initialize GDB and VAPI connections.

Reset the simulator.

Wait for VAPI to connect if configured.

Here is the call graph for this function:

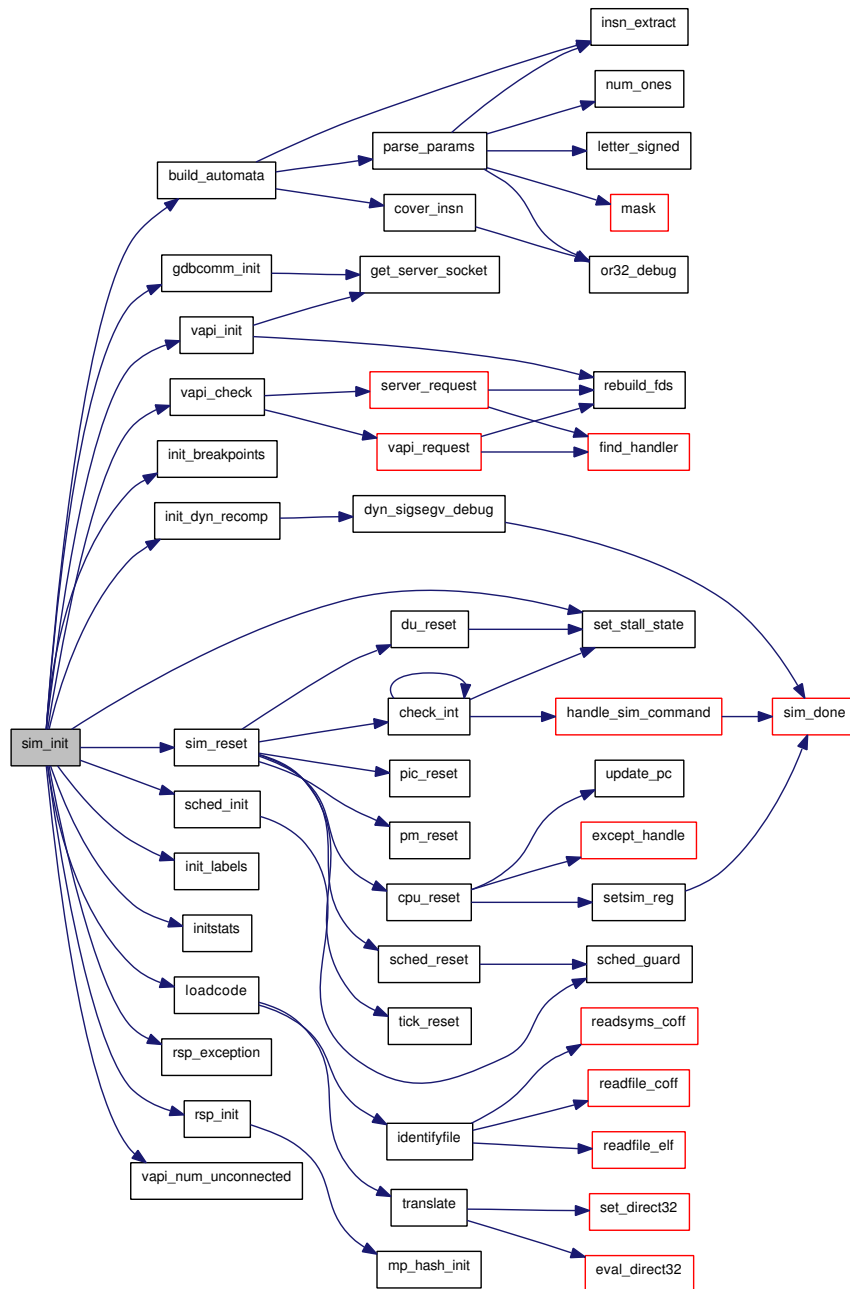

### 6.169.1.6 void sim\_reset ()

Reset the simulator

The scheduler is reset, then all reset functions on the reset hook list (i.e. peripherals) are reset. Then standard core functions (which do not use reset hooks) are reset: tick timer, power management, programmable interrupt controller and debug unit.

The scheduler queue is reinitialized with an immediate check for ctrl-C on its queue.

Finally the count of simulated cycles is set to zero, and the CPU itself is reset.

Here is the call graph for this function:

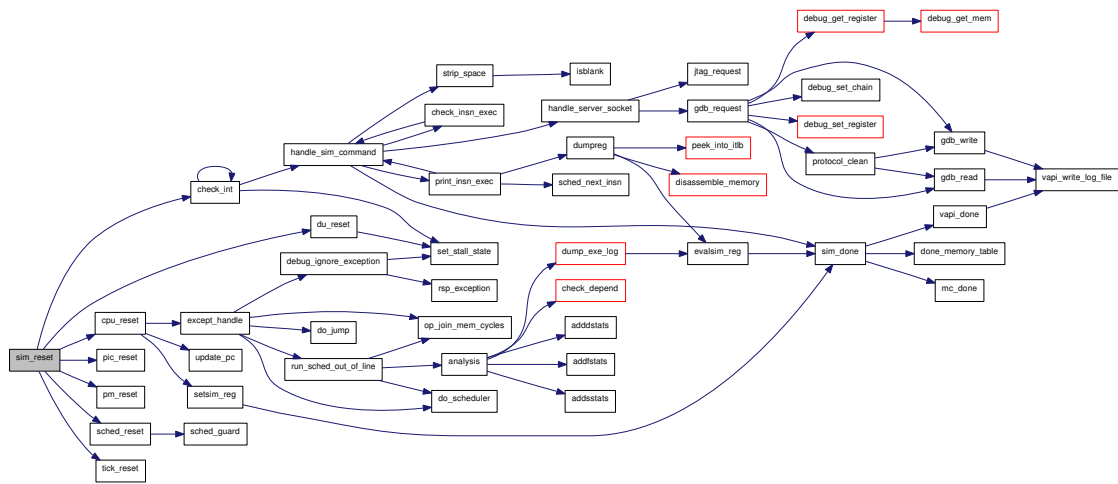



## 6.170 toplevel.c File Reference

```
#include "config.h"
#include <stdlib.h>
#include <unistd.h>
#include <signal.h>
#include "sim-config.h"
#include "toplevel-support.h"
#include "execute.h"
```

Include dependency graph for toplevel.c:

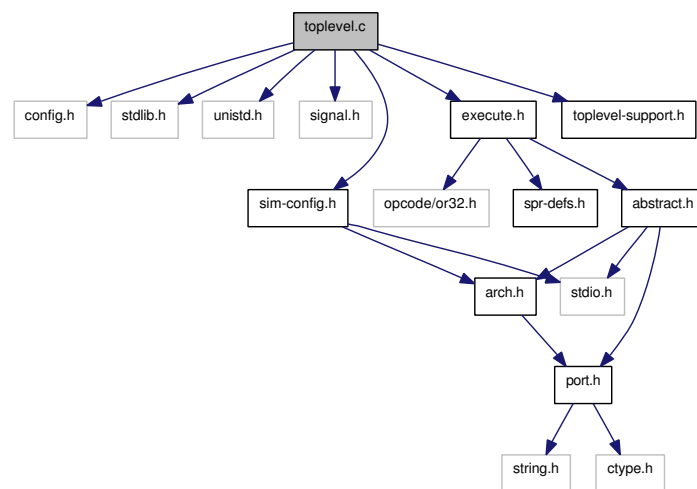

### Functions

- `int main (int argc, char *argv[ ])`

#### 6.170.1 Function Documentation

##### 6.170.1.1 `int main (int argc, char * argv[ ])`

Main function

Set up the standalone simulation. Initialize the default configuration and register all the sections that may appear in a user configuration.

Then attempt to parse the args, configure the system from any configuration file specified and print out the configuration used.

Add a signal handler, so ctrl-C will drop the user into the CLI.

The initialize the simulator, call the appropriate main simulator function and when it returns tidy up.

#### Parameters:

- ← *argc* The number of arguments to the command

← *argv* The vector of argument strings

**Returns:**

The return code required from the simulator. This is actually achieved by calling `exit()` with the return code, rather than returning an explicit value.

Here is the call graph for this function:

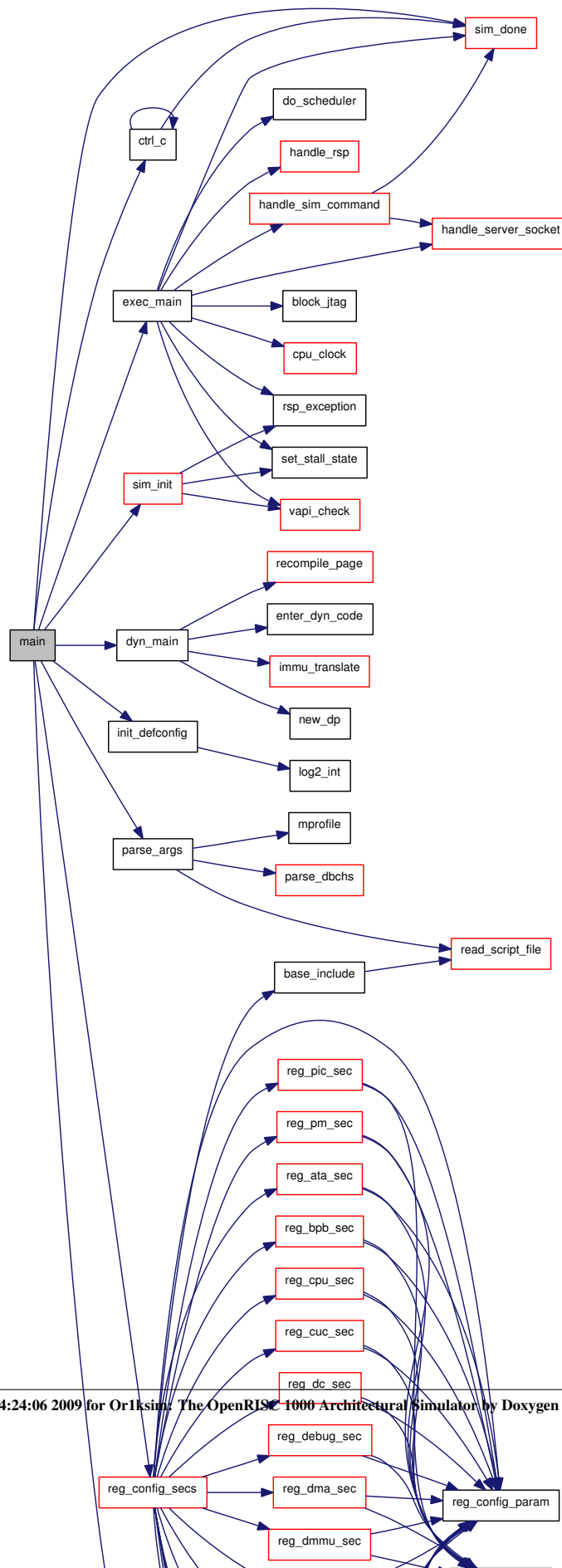

## 6.171 vapi/vapi.c File Reference

```
#include "config.h"
#include "port.h"
#include <stdlib.h>
#include <unistd.h>
#include <stdio.h>
#include <errno.h>
#include <sys/poll.h>
#include <sys/socket.h>
#include <netinet/in.h>
#include <fcntl.h>
#include <netdb.h>
#include <netinet/tcp.h>
#include "sim-config.h"
#include "vapi.h"
```

Include dependency graph for vapi.c:

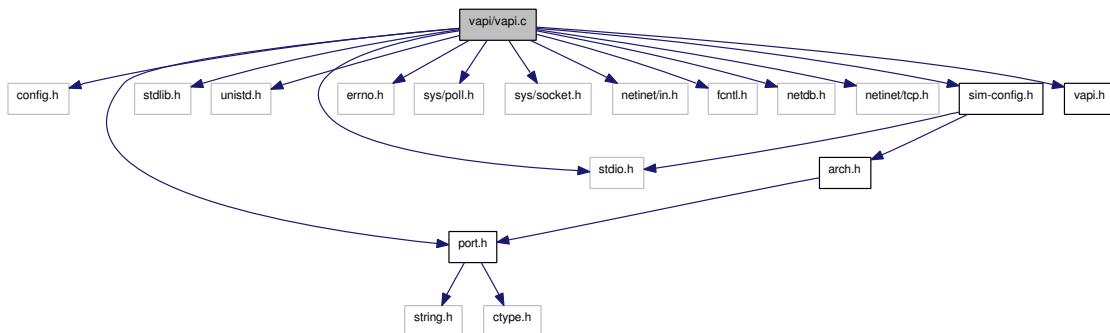

## Data Structures

- struct [vapi\\_handler](#)

## Functions

- void [rebuild\\_fds](#) ()
- static int [handler\\_fits\\_id](#) (const struct [vapi\\_handler](#) \*t, unsigned long id)
- static struct [vapi\\_handler](#) \* [find\\_handler](#) (unsigned long id)
- static struct [vapi\\_handler](#) \* [add\\_handler](#) (unsigned long base\_id, unsigned long num\_ids)
- void [vapi\\_write\\_log\\_file](#) (VAPI\_COMMAND command, unsigned long devid, unsigned long data)
- static int [vapi\\_write\\_stream](#) (int fd, void \*buf, int len)
- static int [vapi\\_read\\_stream](#) (int fd, void \*buf, int len)
- int [get\\_server\\_socket](#) (const char \*name, const char \*proto, int port)

- static void `server_request` ()
- static int `write_packet` (unsigned long id, unsigned long data)
- static int `read_packet` (int fd, unsigned long \*id, unsigned long \*data)
- static void `vapi_request` (struct `vapi_handler` \*t)
- void `vapi_check` ()
- int `vapi_init` ()
- void `vapi_done` ()
- void `vapi_install_handler` (unsigned long id, void(\*read\_func)(unsigned long, unsigned long, void \*), void \*dat)
- void `vapi_install_multi_handler` (unsigned long base\_id, unsigned long num\_ids, void(\*read\_func)(unsigned long, unsigned long, void \*), void \*dat)
- int `vapi_num_unconnected` (int printout)
- void `vapi_send` (unsigned long id, unsigned long data)
- static void `vapi_enabled` (union `param_val` val, void \*dat)
- static void `vapi_server_port` (union `param_val` val, void \*dat)
- static void `vapi_log_enabled` (union `param_val` val, void \*dat)
- static void `vapi_hide_device_id` (union `param_val` val, void \*dat)
- static void `vapi_log_fn` (union `param_val` val, void \*dat)
- void `reg_vapi_sec` (void)

## Variables

- static unsigned int `serverIP` = 0
- static unsigned int `server_fd` = 0
- static unsigned int `nhandlers` = 0
- static int `tcp_level` = 0
- static struct pollfd \* `fds` = NULL
- static int `nfds` = 0

### 6.171.1 Function Documentation

**6.171.1.1** static struct `vapi_handler`\* `add_handler` (unsigned long *base\_id*, unsigned long *num\_ids*)  
[static, read]

Here is the call graph for this function:



**6.171.1.2** static struct `vapi_handler`\* `find_handler` (unsigned long *id*) [static, read]

Here is the call graph for this function:



**6.171.1.3** `int get_server_socket (const char * name, const char * proto, int port)`

**6.171.1.4** `static int handler_fits_id (const struct vapi_handler * t, unsigned long id)` [static]

**6.171.1.5** `static int read_packet (int fd, unsigned long * id, unsigned long * data)` [static]

Here is the call graph for this function:



**6.171.1.6** `void rebuild_fds ()`

**6.171.1.7** `void reg_vapi_sec (void)`

Here is the call graph for this function:

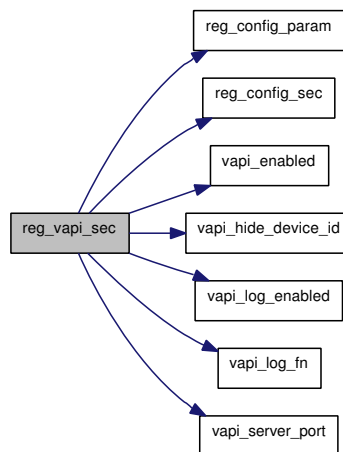

**6.171.1.8** `static void server_request ()` [static]

Here is the call graph for this function:

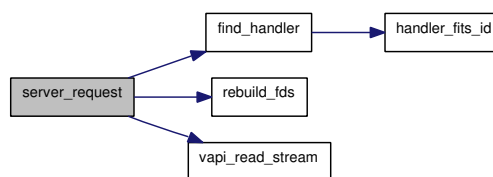

**6.171.1.9 void vapi\_check ()**

Here is the call graph for this function:

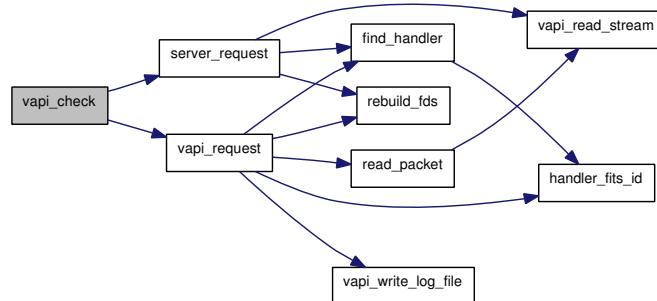
**6.171.1.10 void vapi\_done ()**

Here is the call graph for this function:

**6.171.1.11 static void vapi\_enabled (union param\_val val, void \* dat) [static]****6.171.1.12 static void vapi\_hide\_device\_id (union param\_val val, void \* dat) [static]****6.171.1.13 int vapi\_init ()**

Here is the call graph for this function:

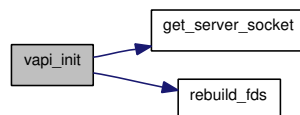
**6.171.1.14 void vapi\_install\_handler (unsigned long id, void(\*) (unsigned long, unsigned long, void \*) read\_func, void \* dat)**

Here is the call graph for this function:

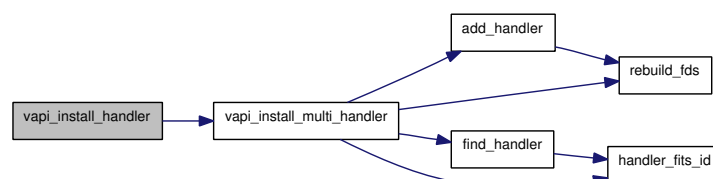

**6.171.1.15** void vapi\_install\_multi\_handler (unsigned long *base\_id*, unsigned long *num\_ids*, void(\*) (unsigned long, unsigned long, void \*) *read\_func*, void \* *dat*)

Here is the call graph for this function:

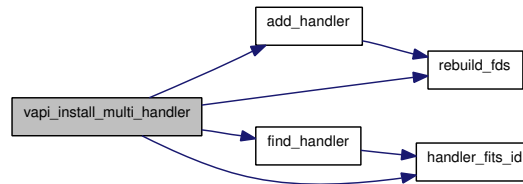

**6.171.1.16** static void vapi\_log\_enabled (union param\_val *val*, void \* *dat*) [static]

**6.171.1.17** static void vapi\_log\_fn (union param\_val *val*, void \* *dat*) [static]

Set the log file

Free any existing string.

#### Parameters:

← *val* The value to use

← *dat* The [config](#) data structure (not used here)

**6.171.1.18** int vapi\_num\_unconnected (int *printout*)

**6.171.1.19** static int vapi\_read\_stream (int *fd*, void \* *buf*, int *len*) [static]

**6.171.1.20** static void vapi\_request (struct vapi\_handler \* *t*) [static]

Here is the call graph for this function:

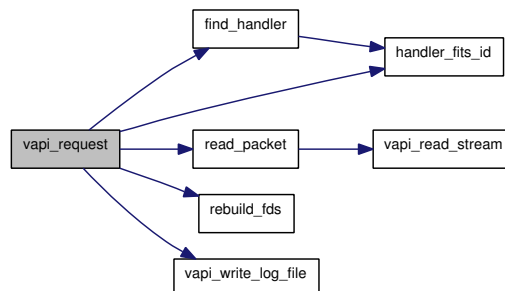



**6.171.1.21 void vapi\_send (unsigned long *id*, unsigned long *data*)**

Here is the call graph for this function:

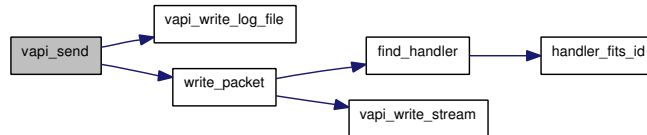
**6.171.1.22 static void vapi\_server\_port (union param\_val *val*, void \* *dat*)** [static]

Set the VAPI server port

Ensure the value chosen is valid

**Parameters:**

← *val* The value to use

← *dat* The [config](#) data structure (not used here)

**6.171.1.23 void vapi\_write\_log\_file (VAPI\_COMMAND *command*, unsigned long *devid*, unsigned long *data*)****6.171.1.24 static int vapi\_write\_stream (int *fd*, void \* *buf*, int *len*)** [static]**6.171.1.25 static int write\_packet (unsigned long *id*, unsigned long *data*)** [static]

Here is the call graph for this function:

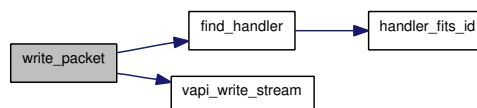
**6.171.2 Variable Documentation****6.171.2.1 struct pollfd\* fds = NULL** [static]**6.171.2.2 int nfds = 0** [static]**6.171.2.3 unsigned int nhandlers = 0** [static]**6.171.2.4 unsigned int server\_fd = 0** [static]**6.171.2.5 unsigned int serverIP = 0** [static]**6.171.2.6 int tcp\_level = 0** [static]

## 6.172 vapi/vapi.h File Reference

This graph shows which files directly or indirectly include this file:

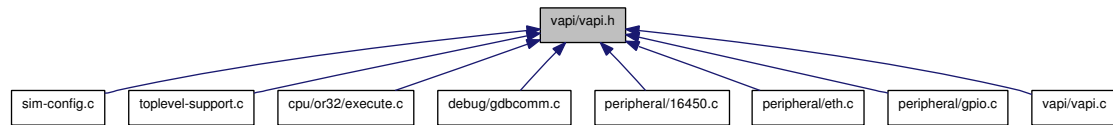

### Defines

- #define `VAPI_MAX_DEVID` 0xFFFF

### Enumerations

- enum `VAPI_COMMAND` { `VAPI_COMMAND_REQUEST` = 0, `VAPI_COMMAND_SEND` = 1, `VAPI_COMMAND_END` = 2 }

### Functions

- int `vapi_init` ()
- void `vapi_done` ()
- void `vapi_install_handler` (unsigned long id, void(\*read\_func)(unsigned long, unsigned long, void \*), void \*dat)
- void `vapi_install_multi_handler` (unsigned long base\_id, unsigned long num\_ids, void(\*read\_func)(unsigned long, unsigned long, void \*), void \*dat)
- void `vapi_check` ()
- int `vapi_num_unconnected` (int printout)
- void `vapi_send` (unsigned long id, unsigned long data)
- void `vapi_write_log_file` (`VAPI_COMMAND` command, unsigned long device\_id, unsigned long data)
- void `reg_vapi_sec` ()

#### 6.172.1 Define Documentation

##### 6.172.1.1 #define VAPI\_MAX\_DEVID 0xFFFF

Maximum value for VAPI device id

#### 6.172.2 Enumeration Type Documentation

##### 6.172.2.1 enum VAPI\_COMMAND

Enumerator:

`VAPI_COMMAND_REQUEST`  
`VAPI_COMMAND_SEND`  
`VAPI_COMMAND_END`

### 6.172.3 Function Documentation

#### 6.172.3.1 void reg\_vapi\_sec ()

Here is the call graph for this function:

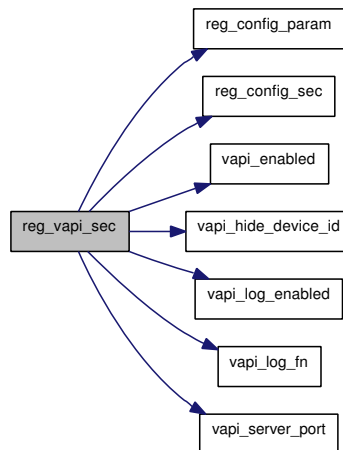

#### 6.172.3.2 void vapi\_check ()

Here is the call graph for this function:

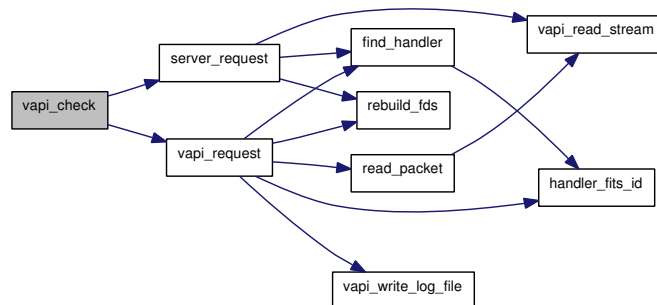

#### 6.172.3.3 void vapi\_done ()

Here is the call graph for this function:



### 6.172.3.4 int vapi\_init ()

Here is the call graph for this function:

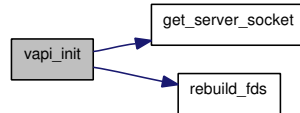

### 6.172.3.5 void vapi\_install\_handler (unsigned long id, void(\*) (unsigned long, unsigned long, void \*) read\_func, void \* dat)

Here is the call graph for this function:

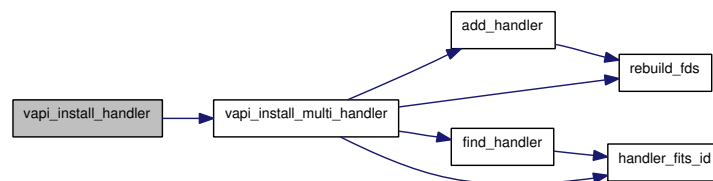

### 6.172.3.6 void vapi\_install\_multi\_handler (unsigned long base\_id, unsigned long num\_ids, void(\*) (unsigned long, unsigned long, void \*) read\_func, void \* dat)

Here is the call graph for this function:

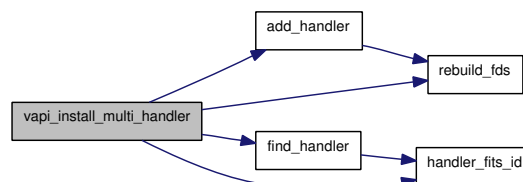

### 6.172.3.7 int vapi\_num\_unconnected (int printout)

### 6.172.3.8 void vapi\_send (unsigned long id, unsigned long data)

Here is the call graph for this function:

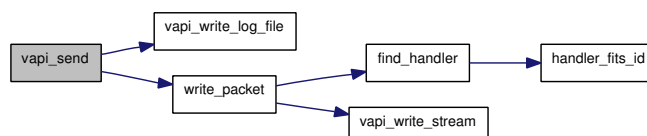

**6.172.3.9** void `vapi_write_log_file` (`VAPI_COMMAND` *command*, unsigned long *device\_id*, unsigned long *data*)

# Index

- `__ORSIM_DBCL_ERR`
  - debug.h, 823
- `__ORSIM_DBCL_FIXME`
  - debug.h, 823
- `__ORSIM_DBCL_TRACE`
  - debug.h, 823
- `__ORSIM_DBCL_WARN`
  - debug.h, 823
- `__DYNAMIC`
  - elf.h, 260
- `__ORSIM_DBG_USE_FUNC`
  - debug.h, 822
- `__ORSIM_DEBUG_CLASS`
  - debug.h, 823
- `__ORSIM_DEBUG_LOG`
  - debug.h, 822
- `__ORSIM_DPRINTF`
  - debug.h, 822
- `__ORSIM_GET_DEBUGGING`
  - debug.h, 822
- `__ORSIM_GET_DEBUGGING_ERR`
  - debug.h, 822
- `__ORSIM_GET_DEBUGGING_FIXME`
  - debug.h, 822
- `__ORSIM_GET_DEBUGGING_TRACE`
  - debug.h, 822
- `__ORSIM_GET_DEBUGGING_WARN`
  - debug.h, 822
- `__ORSIM_NO_DEC_DBCH`
  - debug.c, 820
- `__op_param1`
  - dyn-rec.c, 350
  - op.c, 429
- `__op_param2`
  - dyn-rec.c, 350
  - op.c, 429
- `__op_param3`
  - dyn-rec.c, 350
  - op.c, 429
- `__or_dynop`
  - op.c, 423
- `__orsim_dbchs`
  - debug.c, 820
- `_csm_list`, 13
  - cmatch, 14
- cmovs, 14
- cnt, 14
- dead, 14
- from, 14
- next, 14
- ninsn, 14
- osize, 14
- ref, 14
- size, 14
- `_cuc_func`, 15
  - bb, 16
  - end\_addr, 16
  - fdeps, 16
  - init\_bb\_reloc, 16
  - lur, 16
  - memory\_order, 16
  - msched, 16
  - mtype, 16
  - nfdeps, 16
  - nmsched, 16
  - num\_bb, 16
  - num\_init\_bb, 16
  - num\_runs, 16
  - orig\_time, 16
  - saved\_regs, 16
  - start\_addr, 16
  - timings, 16
  - tmp, 16
  - used\_regs, 16
- `_dep_list_t`, 17
  - next, 17
  - ref, 17
- 16450.c
  - char\_clks, 607
  - MAX\_SKEW, 601
  - MIN, 601
  - reg\_uart\_sec, 607
  - send\_char, 608
  - uart\_16550, 608
  - uart\_add\_char, 608
  - UART\_ADDR\_SPACE, 601
  - uart\_baseaddr, 608
  - UART\_BREAK\_COUNT, 601
  - uart\_channel, 608
  - uart\_char\_clock, 608

UART\_CHAR\_TIMEOUT, 601  
uart\_check\_char, 609  
uart\_check\_rdi, 609  
uart\_check\_rlsi, 609  
uart\_clear\_int, 610  
UART\_CLOCK\_DIVIDER, 601  
UART\_DLH, 601  
UART\_DLL, 601  
uart\_enabled, 610  
UART\_FCR, 601  
UART\_FCR\_FIE, 601  
UART\_FCR\_RRXFI, 601  
UART\_FCR\_RTXFI, 601  
UART\_FGETC\_SLOWDOWN, 601  
UART\_FIFO\_TRIGGER, 601  
UART\_IER, 602  
UART\_IER\_MSI, 604  
UART\_IER\_RDI, 604  
UART\_IER\_RLSI, 604  
UART\_IER\_THRI, 604  
UART\_IIR, 604  
UART\_IIR\_CTI, 604  
UART\_IIR\_ID, 604  
UART\_IIR\_MSI, 604  
UART\_IIR\_NO\_INT, 604  
UART\_IIR\_RDI, 604  
UART\_IIR\_RLSI, 604  
UART\_IIR\_THRI, 604  
uart\_int\_cti, 611  
uart\_int\_msi, 611  
uart\_int\_rdi, 611  
uart\_int\_rlsi, 612  
uart\_int\_thri, 612  
uart\_irq, 613  
uart\_jitter, 613  
UART\_LCR, 604  
UART\_LCR\_DLAB, 604  
UART\_LCR\_EPAR, 604  
UART\_LCR\_PARITY, 604  
UART\_LCR\_RESET, 604  
UART\_LCR\_SBC, 604  
UART\_LCR\_SPAR, 604  
UART\_LCR\_STOP, 604  
UART\_LCR\_WLEN5, 604  
UART\_LCR\_WLEN6, 604  
UART\_LCR\_WLEN7, 604  
UART\_LCR\_WLEN8, 604  
uart\_loopback, 613  
UART\_LSR, 604  
UART\_LSR\_BREAK, 604  
UART\_LSR\_FRAME, 604  
UART\_LSR\_OVRRUN, 604  
UART\_LSR\_PARITY, 604  
UART\_LSR\_RDRDY, 604  
UART\_LSR\_RXERR, 604  
UART\_LSR\_TXBUFE, 604  
UART\_LSR\_TXSERE, 604  
UART\_MAX\_FIFO\_LEN, 604  
UART\_MCR, 604  
UART\_MCR\_AUX1, 605  
UART\_MCR\_AUX2, 605  
UART\_MCR\_DTR, 605  
UART\_MCR\_LOOP, 605  
UART\_MCR\_RTS, 605  
UART\_MSR, 605  
UART\_MSR\_CTS, 605  
UART\_MSR\_DCD, 605  
UART\_MSR\_DCTS, 605  
UART\_MSR\_DDCD, 605  
UART\_MSR\_DDSR, 605  
UART\_MSR\_DSR, 605  
UART\_MSR\_RI, 605  
UART\_MSR\_TERI, 605  
uart\_newway, 613  
uart\_next\_int, 614  
uart\_read\_byte, 614  
uart\_recv\_break, 614  
uart\_recv\_break\_start, 614  
uart\_recv\_break\_stop, 615  
uart\_recv\_char, 615  
uart\_reset, 615  
UART\_RXBUF, 605  
uart\_sched\_recv\_check, 616  
UART\_SCR, 605  
uart\_sec\_end, 616  
uart\_sec\_start, 617  
uart\_send\_break, 617  
uart\_status, 618  
uart\_tx\_send, 618  
UART\_TXBUF, 605  
UART\_VALID\_FCR, 605  
UART\_VALID\_IER, 605  
UART\_VALID\_IIR, 605  
UART\_VALID\_LCR, 605  
UART\_VALID\_LSR, 605  
UART\_VALID\_MCR, 605  
UART\_VALID\_MSR, 605  
UART\_VAPI\_BUF\_LEN, 605  
uart\_vapi\_cmd, 618  
uart\_vapi\_id, 619  
uart\_vapi\_read, 619  
uart\_write\_byte, 619  
16450.h  
reg\_uart\_sec, 622  
uart\_reset, 623  
uart\_status, 623  
a0

- dma\_channel, 81
- a1
  - dma\_channel, 81
- abstract.c
  - adjust\_rw\_delay, 213
  - bit\_mask, 213
  - cur\_area, 228
  - cur\_vadd, 228
  - data\_ci, 228
  - dev\_list, 228
  - disassemble\_memory, 213
  - done\_memory\_table, 213
  - dump\_memory, 213
  - eval\_direct16, 214
  - eval\_direct32, 214
  - eval\_direct8, 215
  - eval\_insn, 215
  - eval\_mem16, 215
  - eval\_mem32, 216
  - eval\_mem8, 216
  - eval\_mem\_16\_inv, 217
  - eval\_mem\_16\_inv\_direct, 217
  - eval\_mem\_32\_inv, 218
  - eval\_mem\_32\_inv\_direct, 218
  - eval\_mem\_8\_inv, 218
  - eval\_mem\_8\_inv\_direct, 218
  - evalsim\_mem16, 219
  - evalsim\_mem32, 219
  - evalsim\_mem8, 219
  - generate\_time\_pretty, 220
  - insn\_ci, 228
  - mc\_area, 228
  - memory\_table\_status, 220
  - reg\_mem\_area, 220
  - register\_memoryarea\_mask, 221
  - set\_direct16, 221
  - set\_direct32, 222
  - set\_direct8, 222
  - set\_mem16, 223
  - set\_mem32, 223
  - set\_mem8, 224
  - set\_mem\_16\_inv, 224
  - set\_mem\_16\_inv\_direct, 225
  - set\_mem\_32\_inv, 225
  - set\_mem\_32\_inv\_direct, 225
  - set\_mem\_8\_inv, 226
  - set\_mem\_8\_inv\_direct, 226
  - set\_mem\_valid, 226
  - set\_program32, 226
  - set\_program8, 226
  - setsim\_mem16, 226
  - setsim\_mem32, 227
  - setsim\_mem8, 227
  - verify\_memoryarea, 228
- abstract.h
  - adjust\_rw\_delay, 231
  - CT\_NONE, 231
  - CT\_PHYSICAL, 231
  - CT\_VIRTUAL, 231
  - cur\_area, 243
  - data\_ci, 243
  - DEFAULT\_MEMORY\_LEN, 231
  - DEFAULT\_MEMORY\_START, 231
  - disassemble\_memory, 231
  - done\_memory\_table, 232
  - dump\_memory, 232
  - eval\_direct16, 232
  - eval\_direct32, 233
  - eval\_direct8, 233
  - eval\_insn, 234
  - eval\_mem16, 234
  - eval\_mem32, 235
  - eval\_mem8, 235
  - evalsim\_mem16, 236
  - evalsim\_mem32, 236
  - evalsim\_mem8, 237
  - generate\_time\_pretty, 237
  - hist\_exec\_tail, 243
  - HISTEXEC\_LEN, 231
  - insn\_ci, 243
  - INSNAME\_LEN, 231
  - LABELNAME\_LEN, 231
  - LE16, 231
  - LONGEST, 231
  - MAX\_OPERANDS, 231
  - memory\_table\_status, 237
  - OP\_MEM\_ACCESS, 231
  - OPERANDNAME\_LEN, 231
  - reg\_mem\_area, 237
  - set\_direct16, 238
  - set\_direct32, 238
  - set\_direct8, 239
  - set\_mem16, 239
  - set\_mem32, 240
  - set\_mem8, 240
  - set\_mem\_valid, 241
  - set\_program32, 241
  - set\_program8, 241
  - setsim\_mem16, 241
  - setsim\_mem32, 242
  - setsim\_mem8, 242
  - STACK\_SIZE, 231
  - ULONGEST, 231
  - verify\_memoryarea, 243
- add\_breakpoint
  - labels.c, 269
  - labels.h, 271
- add\_crc



- eth\_device, 113
- add\_data\_dep
  - cuc.h, 469
  - insn.c, 483
- add\_dep
  - cuc.h, 470
  - insn.c, 483
- add\_handler
  - vapi.c, 869
- add\_label
  - labels.c, 269
  - labels.h, 271
- add\_latches
  - cuc.h, 470
  - insn.c, 483
- add\_memory\_dep
  - cuc.h, 470
  - cuc/memory.c, 500
- add\_to\_op\_params
  - dyn-rec.c, 335
  - dyn-rec.h, 353
- add\_to\_opq
  - dyn-rec.c, 335
  - dyn-rec.h, 353
- addstats
  - stats.c, 281
  - stats.h, 285
- addend
  - reloc, 161
- addfstats
  - stats.c, 281
  - stats.h, 285
- addprogram
  - parse.c, 273
- addr
  - bpb\_entry, 30
  - breakpoint\_entry, 33
  - btic\_entry, 34
  - fb\_state, 118
  - func\_struct, 122
  - hist\_exec, 125
  - label\_entry, 145
  - memory\_hash, 153
  - mp\_entry, 154
  - mprofentry\_struct, 155
  - stack\_struct, 175
- ADDR\_C
  - arch.h, 290
- addr\_compare
  - dev\_memarea, 79
- addr\_mask
  - dev\_memarea, 79
- addr\_val
  - param\_val, 159
- address
  - jtr\_read\_block\_message, 136
  - jtr\_read\_message, 138
  - jtr\_write\_block\_message, 140
  - jtr\_write\_message, 142
- addstats
  - stats.c, 281
  - stats.h, 285
- adjust\_rw\_delay
  - abstract.c, 213
  - abstract.h, 231
- adv.c
  - calc\_max, 441
  - detect\_max\_values, 441
  - insert\_conditional\_facts, 441
  - mark\_successors, 441
  - mask, 441
  - max\_op, 441
- am0
  - dma\_channel, 81
- am1
  - dma\_channel, 81
- analyse\_function
  - cuc.c, 451
- analyse\_timings
  - cuc.h, 470
  - timings.c, 508
- analysis
  - execute.c, 367
  - execute.h, 262
- apply\_edge\_condition
  - insn.c, 483
- arch.h
  - ADDR\_C, 290
  - LINK\_REGNO, 290
  - oraddr\_t, 291
  - orreg\_t, 291
  - PRIdREG, 290
  - PRIxADDR, 290
  - PRIxREG, 291
  - REG\_C, 291
  - uorreg\_t, 291
- archf, 18
  - gen\_func\_reloc, 18
  - gen\_reloc, 18
  - get\_real\_func\_len, 18
- archfs
  - dyngen-i386.c, 360
  - dyngen.h, 365
- argv
  - xterm\_channel, 181
- ascii2hex
  - rsp-server.c, 541
- asm

- op-i386.h, 403
- op.c, 423
- ASSIGN\_FLAG
  - fields.h, 723
- AT\_BASE
  - elf.h, 257
- AT\_EGID
  - elf.h, 257
- AT\_ENTRY
  - elf.h, 257
- AT\_EUID
  - elf.h, 257
- AT\_EXECPD
  - elf.h, 257
- AT\_FLAGS
  - elf.h, 257
- AT\_GID
  - elf.h, 257
- AT\_IGNORE
  - elf.h, 257
- AT\_NOTELF
  - elf.h, 257
- AT\_NULL
  - elf.h, 257
- AT\_PAGESZ
  - elf.h, 257
- AT\_PHDR
  - elf.h, 257
- AT\_PHEMT
  - elf.h, 257
- AT\_PHNUM
  - elf.h, 257
- AT\_UID
  - elf.h, 257
- ATA\_ADDR\_SPACE
  - atahost.h, 660
- ATA\_ASR
  - atadevice.h, 645
- ata\_baseaddr
  - atahost.c, 649
- ATA\_BELECO
  - atahost.h, 660
- ATA\_BELEC1
  - atahost.h, 660
- ata\_calc\_lba
  - atadevice-cmdi.c, 629
- ATA\_CHR
  - atadevice.h, 645
- ATA\_CLR
  - atadevice.h, 645
- ata\_cmd\_complete
  - atadevice-cmdi.c, 629
- ATA\_CR
  - atadevice.h, 645
- ATA\_CTRL
  - atahost.h, 660
- ATA\_DA
  - atadevice.h, 645
- ATA\_DAR\_DS0
  - atadevice.h, 645
- ATA\_DAR\_DS1
  - atadevice.h, 645
- ATA\_DAR\_H
  - atadevice.h, 645
- ATA\_DAR\_WTG
  - atadevice.h, 645
- ATA\_DCR
  - atadevice.h, 645
- ATA\_DCR\_IEN
  - atadevice.h, 645
- ATA\_DCR\_RST
  - atadevice.h, 645
- ata\_dev\_id
  - atahost.c, 649
- ata\_device, 19
  - command, 22
  - conf, 22
  - cylinder\_high, 22
  - cylinder\_low, 22
  - daspi, 22
  - daspo, 22
  - dataport\_i, 22
  - dbuf, 22
  - dbuf\_cnt, 22
  - dbuf\_ptr, 22
  - dev, 22
  - device\_control, 22
  - device\_head, 22
  - dma\_mode, 22
  - dmarq, 22
  - end\_t\_func, 22
  - error, 22
  - features, 22
  - file, 22
  - firmware, 22
  - heads, 22
  - heads\_per\_cylinder, 22
  - host, 22
  - internals, 22
  - intrq, 22
  - iordy, 22
  - lba, 22
  - mwdma, 22
  - nr\_sect, 22
  - packet, 22
  - pdiagi, 22
  - pdiago, 22
  - pio, 22

- pio\_mode, 22
- regs, 22
- sector\_count, 22
- sector\_number, 22
- sectors, 22
- sectors\_per\_track, 22
- sigs, 22
- size, 22
- size\_sect, 22
- state, 22
- status, 22
- stream, 22
- type, 22
- ata\_device\_do\_command\_register
  - atadevice.c, 639
- ata\_device\_do\_control\_register
  - atadevice.c, 639
- ata\_device\_execute\_cmd
  - atadevice-cmdi.c, 629
  - atadevice-cmdi.h, 636
- ata\_device\_hw\_reset
  - atadevice.c, 639
- ata\_device\_init
  - atadevice.c, 639
- ata\_device\_reset\_cmd
  - atadevice-cmdi.c, 629
- ata\_device\_write
  - atadevice.c, 639
- ata\_devices, 24
  - device, 24
- ata\_devices\_hw\_reset
  - atadevice.c, 640
  - atadevice.h, 645
- ata\_devices\_init
  - atadevice.c, 640
  - atadevice.h, 646
- ata\_devices\_read
  - atadevice.c, 640
  - atadevice.h, 646
- ata\_devices\_write
  - atadevice.c, 640
  - atadevice.h, 646
- ATA\_DEVID
  - atahost.h, 660
- ATA\_DHR
  - atadevice.h, 645
- ATA\_DHR\_DEV
  - atadevice.h, 645
- ATA\_DHR\_H
  - atadevice.h, 645
- ATA\_DHR\_LBA
  - atadevice.h, 645
- ata\_dma\_delay
  - atahost.h, 660
- ATA\_DMA\_EN
  - atahost.h, 660
- ata\_dma\_mode0\_td
  - atahost.c, 649
- ata\_dma\_mode0\_tec
  - atahost.c, 649
- ata\_dma\_mode0\_tm
  - atahost.c, 649
- ATA\_DMA\_RD
  - atahost.h, 660
- ATA\_DMA\_TIP
  - atahost.h, 660
- ATA\_DMA\_WR
  - atahost.h, 660
- ATA\_DMARQ
  - atahost.h, 660
- ATA\_DR
  - atadevice.h, 645
- ATA\_DRBE
  - atahost.h, 660
- ATA\_DTBF
  - atahost.h, 660
- ATA\_DTR0
  - atahost.h, 660
- ATA\_DTR1
  - atahost.h, 660
- ata\_enabled
  - atahost.c, 649
- ata\_enddevice
  - atahost.c, 649
- ATA\_ERR
  - atadevice.h, 645
- ATA\_ERR\_ABT
  - atadevice.h, 645
- ATA\_ERR\_AMN
  - atadevice.h, 645
- ATA\_ERR\_BBK
  - atadevice.h, 645
- ATA\_ERR\_IDNF
  - atadevice.h, 645
- ATA\_ERR\_TON
  - atadevice.h, 645
- ATA\_ERR\_UNC
  - atadevice.h, 645
- ata\_execute\_device\_diagnostics\_cmd
  - atadevice-cmdi.c, 629
  - atadevice-cmdi.h, 637
- ata\_file
  - atahost.c, 649
- ata\_firmware
  - atahost.c, 649
- ATA\_FR
  - atadevice.h, 645
- ATA\_FTE0

- atahost.h, 660
- ATA\_FTE1
  - atahost.h, 660
- ata\_heads
  - atahost.c, 650
- ata\_host, 25
  - baseaddr, 26
  - ctrl, 26
  - dev\_id, 26
  - dev\_sel, 26
  - devices, 26
  - dma\_mode0\_td, 26
  - dma\_mode0\_teoc, 26
  - dma\_mode0\_tm, 26
  - dtr0, 26
  - dtr1, 26
  - enabled, 26
  - irq, 26
  - mem, 26
  - pctr, 26
  - pftr0, 26
  - pftr1, 26
  - pio\_mode0\_t1, 26
  - pio\_mode0\_t2, 26
  - pio\_mode0\_t4, 26
  - pio\_mode0\_teoc, 26
  - regs, 26
  - rev, 26
  - rxb, 26
  - stat, 26
  - txb, 26
- ATA\_IDE\_EN
  - atahost.h, 660
- ATA\_IDEIS
  - atahost.h, 660
- ata\_identify\_device\_cmd
  - atadevice-cmdi.c, 630
- ata\_initialize\_device\_parameters\_cmd
  - atadevice-cmdi.c, 630
- ata\_int
  - atahost.c, 650
  - atahost.h, 660
- ATA\_IORDY
  - atahost.h, 660
- ATA\_IORDY\_FTE0
  - atahost.h, 660
- ATA\_IORDY\_FTE1
  - atahost.h, 660
- ata\_irq
  - atahost.c, 650
- ata\_mwdma
  - atahost.c, 650
- ata\_packet
  - atahost.c, 650
- ATA\_PCTR
  - atahost.h, 660
- ATA\_PFTR0
  - atahost.h, 660
- ATA\_PFTR1
  - atahost.h, 660
- ata\_pio
  - atahost.c, 650
- ata\_pio\_delay
  - atahost.h, 660
- ata\_pio\_mode0\_t1
  - atahost.c, 650
- ata\_pio\_mode0\_t2
  - atahost.c, 651
- ata\_pio\_mode0\_t4
  - atahost.c, 651
- ata\_pio\_mode0\_teoc
  - atahost.c, 651
- ATA\_PIO\_TIP
  - atahost.h, 660
- ATA\_PWPP
  - atahost.h, 660
- ATA\_PWPPF
  - atahost.h, 660
- ata\_read32
  - atahost.c, 651
- ata\_read\_native\_max\_addr
  - atadevice-cmdi.c, 630
- ata\_read\_sect
  - atadevice-cmdi.c, 630
- ata\_read\_sectors\_cmd
  - atadevice-cmdi.c, 630
- ata\_reset
  - atahost.c, 651
- ata\_rev
  - atahost.c, 651
- ATA\_REVNO
  - atahost.h, 660
- ATA\_RST
  - atahost.h, 660
- ATA\_RXB
  - atahost.h, 660
- ATA\_SCR
  - atadevice.h, 645
- ata\_sec\_end
  - atahost.c, 651
- ata\_sec\_start
  - atahost.c, 652
- ata\_sectors
  - atahost.c, 652
- ata\_set\_device\_signature
  - atadevice-cmdi.c, 631
- ata\_set\_features
  - atadevice-cmdi.c, 631

- ata\_set\_sect
  - atadevice-cmdi.c, [631](#)
- ata\_size
  - atahost.c, [653](#)
- ATA\_SNR
  - atadevice.h, [645](#)
- ATA\_SR
  - atadevice.h, [645](#)
- ATA\_SR\_BSY
  - atadevice.h, [645](#)
- ATA\_SR\_COR
  - atadevice.h, [645](#)
- ATA\_SR\_DF
  - atadevice.h, [645](#)
- ATA\_SR\_DRDY
  - atadevice.h, [645](#)
- ATA\_SR\_DRQ
  - atadevice.h, [645](#)
- ATA\_SR\_DSC
  - atadevice.h, [645](#)
- ATA\_SR\_ERR
  - atadevice.h, [645](#)
- ATA\_SR\_IDX
  - atadevice.h, [645](#)
- ata\_start\_device
  - atahost.c, [653](#)
- ATA\_STAT
  - atahost.h, [660](#)
- ATA\_STATE\_HW\_RST
  - atadevice.h, [645](#)
- ATA\_STATE\_IDLE
  - atadevice.h, [645](#)
- ATA\_STATE\_SW\_RST
  - atadevice.h, [645](#)
- ata\_status
  - atahost.c, [653](#)
- ATA\_T1
  - atahost.h, [660](#)
- ATA\_T2
  - atahost.h, [660](#)
- ATA\_T4
  - atahost.h, [660](#)
- ATA\_TD
  - atahost.h, [660](#)
- ATA\_TEOC
  - atahost.h, [660](#)
- ATA\_TM
  - atahost.h, [660](#)
- ATA\_TXB
  - atahost.h, [660](#)
- ata\_type
  - atahost.c, [653](#)
- ata\_write32
  - atahost.c, [653](#)
- ata\_write\_sect
  - atadevice-cmdi.c, [631](#)
- ata\_write\_sectors
  - atadevice-cmdi.c, [631](#)
- atacmd.h
  - CFA\_DISABLE\_8BIT\_PIO\_TRANSFER\_ -  
MODE, [627](#)
  - CFA\_DISABLE\_POWER\_MODE1, [627](#)
  - CFA\_ENABLE\_8BIT\_PIO\_TRANSFER\_ -  
MODE, [627](#)
  - CFA\_ENABLE\_POWER\_MODE1, [627](#)
  - CFA\_ERASE\_SECTORS, [627](#)
  - CFA\_REQUEST\_EXTENDED\_ERROR\_ -  
CODE, [627](#)
  - CFA\_TRANSLATE\_SECTOR, [627](#)
  - CFA\_WRITE\_MULTIPLE\_WITHOUT\_ -  
ERASE, [627](#)
  - CFA\_WRITE\_SECTORS\_WITHOUT\_ -  
ERASE, [627](#)
  - CHECK\_POWER\_MODE, [627](#)
  - DEVICE\_RESET, [627](#)
  - DISABLE\_ADVANCED\_POWER\_ -  
MANAGEMENT, [627](#)
  - DISABLE\_MEDIA\_STATUS\_ -  
NOTIFICATION, [627](#)
  - DISABLE\_POWERUP\_IN\_STANDBY\_ -  
FEATURE\_SET, [627](#)
  - DISABLE\_READ\_LOOKAHEAD, [627](#)
  - DISABLE\_RELEASE\_INTERRUPT, [627](#)
  - DISABLE\_REVERTING\_TO\_POWERON\_ -  
DEFAULTS, [627](#)
  - DISABLE\_SERVICE\_INTERRUPT, [627](#)
  - DISABLE\_WRITE\_CACHE, [627](#)
  - DOWNLOAD\_MICROCODE, [627](#)
  - ENABLE\_ADVANCED\_POWER\_ -  
MANAGEMENT, [627](#)
  - ENABLE\_MEDIA\_STATUS\_ -  
NOTIFICATION, [627](#)
  - ENABLE\_POWERUP\_IN\_STANDBY\_ -  
FEATURE\_SET, [627](#)
  - ENABLE\_READ\_LOOKAHEAD\_ -  
FEATURE, [627](#)
  - ENABLE\_RELEASE\_INTERRUPT, [627](#)
  - ENABLE\_REVERTING\_TO\_POWERON\_ -  
DEFAULTS, [627](#)
  - ENABLE\_SERVICE\_INTERRUPT, [627](#)
  - ENABLE\_WRITE\_CACHE, [627](#)
  - EXECUTE\_DEVICE\_DIAGNOSTICS, [627](#)
  - FLUSH\_CACHE, [627](#)
  - GET\_MEDIA\_STATUS, [627](#)
  - IDENTIFY\_DEVICE, [627](#)
  - IDENTIFY\_PACKET\_DEVICE, [627](#)
  - IDLE, [627](#)
  - IDLE\_IMMEDIATE, [627](#)

- INITIALIZE\_DEVICE\_PARAMETERS, 627
- MEDIA\_EJECT, 627
- MEDIA\_LOCK, 627
- MEDIA\_UNLOCK, 627
- NOP, 627
- PACKET, 627
- POWERUP\_IN\_STANDBY\_FEATURE\_-  
SET\_SPINUP, 627
- READ\_BUFFER, 627
- READ\_DMA, 627
- READ\_DMA\_QUEUED, 627
- READ\_MULTIPLE, 627
- READ\_NATIVE\_MAX\_ADDRESS, 627
- READ\_SECTOR, 627
- READ\_SECTORS, 627
- READ\_VERIFY\_SECTOR, 627
- READ\_VERIFY\_SECTORS, 627
- SECURITY\_DISABLE\_PASSWORD, 627
- SECURITY\_ERASE\_PREPARE, 627
- SECURITY\_ERASE\_UNIT, 627
- SECURITY\_FREEZE\_LOCK, 627
- SECURITY\_SET\_PASSWORD, 627
- SECURITY\_UNLOCK, 627
- SEEK, 627
- SERVICE, 627
- SET\_FEATURES, 627
- SET\_MAX, 627
- SET\_MAX\_ADDRESS, 627
- SET\_MAX\_FREEZE\_LOCK, 627
- SET\_MAX\_LOCK, 627
- SET\_MAX\_SET\_PASSWORD, 627
- SET\_MAX\_UNLOCK, 627
- SET\_MULTIPLE\_MODE, 627
- SET\_TRANSFER\_MODE\_SECTOR\_-  
COUNT\_REG, 627
- SLEEP, 627
- SMART, 627
- SMART\_ATTRIBUTE\_AUTOSAVE, 627
- SMART\_DISABLE\_OPERATIONS, 627
- SMART\_ENABLE\_OPERATIONS, 627
- SMART\_EXECUTE\_OFFLINE\_-  
IMMEDIATE, 627
- SMART\_READ\_DATA, 627
- SMART\_READ\_LOG, 627
- SMART\_RETURN\_STATUS, 627
- SMART\_SAVE\_ATTRIBUTE\_VALUES, 627
- SMART\_WRITE\_LOG, 627
- STANDBY, 627
- STANDBY\_IMMEDIATE, 627
- WRITE\_BUFFER, 627
- WRITE\_DMA, 627
- WRITE\_DMA\_QUEUED, 627
- WRITE\_MULTIPLE, 627
- WRITE\_SECTOR, 627
- WRITE\_SECTORS, 627
- atadevice-cmdi.c
  - ata\_calc\_lba, 629
  - ata\_cmd\_complete, 629
  - ata\_device\_execute\_cmd, 629
  - ata\_device\_reset\_cmd, 629
  - ata\_execute\_device\_diagnostics\_cmd, 629
  - ata\_identify\_device\_cmd, 630
  - ata\_initialize\_device\_parameters\_cmd, 630
  - ata\_read\_native\_max\_addr, 630
  - ata\_read\_sect, 630
  - ata\_read\_sectors\_cmd, 630
  - ata\_set\_device\_signature, 631
  - ata\_set\_features, 631
  - ata\_set\_sect, 631
  - ata\_write\_sect, 631
  - ata\_write\_sectors, 631
- atadevice-cmdi.h
  - ata\_device\_execute\_cmd, 636
  - ata\_execute\_device\_diagnostics\_cmd, 637
  - BYTES\_PER\_SECTOR, 636
  - MIN\_MWDMA\_CYCLE\_TIME, 636
  - MIN\_PIO\_CYCLE\_TIME\_IORDY, 636
  - MIN\_PIO\_CYCLE\_TIME\_NO\_IORDY, 636
  - QUEUE\_DEPTH, 636
  - RECOMMENDED\_MWDMA\_CYCLE\_-  
TIME, 636
  - SET\_FEATURES\_REQUIRED\_AFTER\_-  
POWER\_UP, 636
  - SUPPORT\_APM, 636
  - SUPPORT\_CFA, 636
  - SUPPORT\_DEVICE\_RESET\_CMD, 636
  - SUPPORT\_DOWNLOAD\_MICROCODE,  
636
  - SUPPORT\_HOST\_PROTECTED\_AREA,  
636
  - SUPPORT\_LOOKAHEAD, 636
  - SUPPORT\_NOP\_CMD, 636
  - SUPPORT\_POWER\_MANAGEMENT, 636
  - SUPPORT\_POWER\_UP\_IN\_STANDBY\_-  
MODE, 636
  - SUPPORT\_READ\_BUFFER\_CMD, 636
  - SUPPORT\_READ\_WRITE\_DMA\_-  
QUEUED, 636
  - SUPPORT\_RELEASE\_INTERRUPT, 636
  - SUPPORT\_REMOVABLE\_MEDIA, 636
  - SUPPORT\_REMOVABLE\_MEDIA\_-  
NOTIFICATION, 636
  - SUPPORT\_SECURITY\_MODE, 636
  - SUPPORT\_SERVICE\_INTERRUPT, 636
  - SUPPORT\_SET\_MAX, 636
  - SUPPORT\_SMART, 636
  - SUPPORT\_WRITE\_BUFFER\_CMD, 636
  - SUPPORT\_WRITE\_CACHE, 636

## atadevice.c

ata\_device\_do\_command\_register, 639  
 ata\_device\_do\_control\_register, 639  
 ata\_device\_hw\_reset, 639  
 ata\_device\_init, 639  
 ata\_device\_write, 639  
 ata\_devices\_hw\_reset, 640  
 ata\_devices\_init, 640  
 ata\_devices\_read, 640  
 ata\_devices\_write, 640  
 open\_file, 640  
 open\_local, 641

## atadevice.h

ATA\_ASR, 645  
 ATA\_CHR, 645  
 ATA\_CLR, 645  
 ATA\_CR, 645  
 ATA\_DA, 645  
 ATA\_DAR\_DS0, 645  
 ATA\_DAR\_DS1, 645  
 ATA\_DAR\_H, 645  
 ATA\_DAR\_WTG, 645  
 ATA\_DCR, 645  
 ATA\_DCR\_IEN, 645  
 ATA\_DCR\_RST, 645  
 ata\_devices\_hw\_reset, 645  
 ata\_devices\_init, 646  
 ata\_devices\_read, 646  
 ata\_devices\_write, 646  
 ATA\_DHR, 645  
 ATA\_DHR\_DEV, 645  
 ATA\_DHR\_H, 645  
 ATA\_DHR\_LBA, 645  
 ATA\_DR, 645  
 ATA\_ERR, 645  
 ATA\_ERR\_ABT, 645  
 ATA\_ERR\_AMN, 645  
 ATA\_ERR\_BBK, 645  
 ATA\_ERR\_IDNF, 645  
 ATA\_ERR\_TON, 645  
 ATA\_ERR\_UNC, 645  
 ATA\_FR, 645  
 ATA\_SCR, 645  
 ATA\_SNR, 645  
 ATA\_SR, 645  
 ATA\_SR\_BSY, 645  
 ATA\_SR\_COR, 645  
 ATA\_SR\_DF, 645  
 ATA\_SR\_DRDY, 645  
 ATA\_SR\_DRQ, 645  
 ATA\_SR\_DSC, 645  
 ATA\_SR\_ERR, 645  
 ATA\_SR\_IDX, 645  
 ATA\_STATE\_HW\_RST, 645

ATA\_STATE\_IDLE, 645  
 ATA\_STATE\_SW\_RST, 645  
 TYPE\_FILE, 645  
 TYPE\_LOCAL, 645  
 TYPE\_NO\_CONNECT, 645

## atahost.c

ata\_baseaddr, 649  
 ata\_dev\_id, 649  
 ata\_dma\_mode0\_td, 649  
 ata\_dma\_mode0\_teoc, 649  
 ata\_dma\_mode0\_tm, 649  
 ata\_enabled, 649  
 ata\_enddevice, 649  
 ata\_file, 649  
 ata\_firmware, 649  
 ata\_heads, 650  
 ata\_int, 650  
 ata\_irq, 650  
 ata\_mwdma, 650  
 ata\_packet, 650  
 ata\_pio, 650  
 ata\_pio\_mode0\_t1, 650  
 ata\_pio\_mode0\_t2, 651  
 ata\_pio\_mode0\_t4, 651  
 ata\_pio\_mode0\_teoc, 651  
 ata\_read32, 651  
 ata\_reset, 651  
 ata\_rev, 651  
 ata\_sec\_end, 651  
 ata\_sec\_start, 652  
 ata\_sectors, 652  
 ata\_size, 653  
 ata\_start\_device, 653  
 ata\_status, 653  
 ata\_type, 653  
 ata\_write32, 653  
 conf\_dev, 656  
 DMA\_MODE0\_TD, 649  
 DMA\_MODE0\_TEOC, 649  
 DMA\_MODE0\_TM, 649  
 PIO\_MODE0\_T1, 649  
 PIO\_MODE0\_T2, 649  
 PIO\_MODE0\_T4, 649  
 PIO\_MODE0\_TEOC, 649  
 reg\_ata\_sec, 653

## atahost.h

ATA\_ADDR\_SPACE, 660  
 ATA\_BELEC0, 660  
 ATA\_BELEC1, 660  
 ATA\_CTRL, 660  
 ATA\_DEVID, 660  
 ata\_dma\_delay, 660  
 ATA\_DMA\_EN, 660  
 ATA\_DMA\_RD, 660

- ATA\_DMA\_TIP, 660
- ATA\_DMA\_WR, 660
- ATA\_DMARQ, 660
- ATA\_DRBE, 660
- ATA\_DTBF, 660
- ATA\_DTR0, 660
- ATA\_DTR1, 660
- ATA\_FTE0, 660
- ATA\_FTE1, 660
- ATA\_IDE\_EN, 660
- ATA\_IDEIS, 660
- ata\_int, 660
- ATA\_IORDY, 660
- ATA\_IORDY\_FTE0, 660
- ATA\_IORDY\_FTE1, 660
- ATA\_PCTR, 660
- ATA\_PFTR0, 660
- ATA\_PFTR1, 660
- ata\_pio\_delay, 660
- ATA\_PIO\_TIP, 660
- ATA\_PWPP, 660
- ATA\_PWPPF, 660
- ATA\_REVNO, 660
- ATA\_RST, 660
- ATA\_RXB, 660
- ATA\_STAT, 660
- ATA\_T1, 660
- ATA\_T2, 660
- ATA\_T4, 660
- ATA\_TD, 660
- ATA\_TEOC, 660
- ATA\_TM, 660
- ATA\_TXB, 660
- is\_ata\_hostadr, 660
- reg\_ata\_sec, 661
- audio\_cnt
  - sprs.c, 322
- automata
  - or32.c, 435
- aux
  - gpio\_device, 124
- auxiliary\_inputs
  - gpio\_device, 124
- b
  - cuc\_timings, 69
- ba\_mask
  - mc, 147
- backward
  - branchstat, 32
- base\_id
  - vapi\_handler, 178
- base\_include
  - sim-config.c, 805
- base\_vapi\_id
  - eth\_device, 113
  - gpio\_device, 124
- baseaddr
  - ata\_host, 26
  - dev\_16450, 74
  - dev\_generic, 77
  - dma\_controller, 84
  - eth\_device, 113
  - fb\_state, 118
  - gpio\_device, 124
  - kbd\_state, 144
  - mc, 147
  - mem\_config, 150
  - vga\_state, 180
- basename
  - xterm.c, 679
- baud\_table
  - tty.c, 676
- bb
  - \_cuc\_func, 16
- bb.c
  - build\_bb, 443
  - count\_bb\_seq, 443
  - cpy\_bb, 443
  - cuc\_check, 443
  - detect\_bb, 443
  - dup\_func, 444
  - expand\_bb, 444
  - free\_func, 444
  - generate\_bb\_seq, 444
  - join\_bb, 444
  - optimize\_bb, 445
  - preunroll\_loop, 445
  - print\_bb\_num, 445
  - print\_cuc\_bb, 446
  - recalc\_last\_used\_reg, 446
  - reg\_dep, 446
  - reg\_dep\_rec, 446
  - relocate\_bb, 446
  - remove\_dead\_bb, 446
  - roll\_loop, 446
  - simplify\_bb, 446
- BB\_DEAD
  - cuc.h, 469
- BB\_INLOOP
  - cuc.h, 469
- BB\_OPTIONAL
  - cuc.h, 469
- bb\_size
  - timings.c, 508
- BBID\_END
  - cuc.h, 469
- BBID\_START



- cuc.h, 469
- bd
  - eth\_device, 113
- bd\_addr
  - eth\_device, 113
- bd\_index
  - eth\_device, 113
- bd\_ram
  - eth\_device, 113
- bf
  - mstats\_entry, 156
- bff, 28
  - close\_obj, 28
  - get\_func\_len, 28
  - get\_func\_name, 28
  - get\_func\_reloc, 28
  - get\_func\_start, 28
  - open\_obj, 28
- bffs
  - dyngen-elf.c, 359
  - dyngen.h, 365
- bit\_mask
  - abstract.c, 213
- bits
  - INFOHEADER, 131
  - spr\_def, 173
- block\_jtag
  - gdbcomm.c, 532
  - gdbcomm.h, 535
- block\_mask
  - ic, 127
- block\_offset\_mask
  - ic, 127
- blocksize
  - config, 55
  - ic, 127
- blocksize\_log2
  - ic, 127
- BMP\_HEADER, 29
  - offset, 29
  - reserved1, 29
  - reserved2, 29
  - size, 29
  - type, 29
- bnf
  - mstats\_entry, 156
- boolean
  - gdbcomm.h, 535
- BP\_HARDWARE
  - rsp-server.c, 540
- BP\_MEMORY
  - rsp-server.c, 540
- bpb
  - branch-predict.c, 187
  - config, 55
  - mstats\_entry, 156
  - bpb/branch-predict.c, 183
  - bpb/branch-predict.h, 188
  - bpb\_btic
    - branch-predict.c, 186
  - bpb\_enabled
    - branch-predict.c, 186
  - bpb\_entry, 30
    - addr, 30
    - lru, 30
    - taken, 30
    - way, 30
  - bpb\_hitdelay
    - branch-predict.c, 186
  - bpb\_info
    - branch-predict.c, 186
    - branch-predict.h, 189
  - BPB\_LEN
    - branch-predict.c, 186
  - bpb\_missdelay
    - branch-predict.c, 186
  - BPB\_PSTATES
    - branch-predict.c, 186
  - bpb\_sbp\_bf\_fwd
    - branch-predict.c, 186
  - bpb\_sbp\_bnf\_fwd
    - branch-predict.c, 186
  - bpb\_update
    - branch-predict.c, 186
    - branch-predict.h, 189
  - BPB\_USTATES
    - branch-predict.c, 186
  - BPB\_WAYS
    - branch-predict.c, 186
  - bpbstat, 31
    - correct, 31
    - hit, 31
    - incorrect, 31
    - miss, 31
  - branch-predict.c
    - bpb, 187
    - bpb\_btic, 186
    - bpb\_enabled, 186
    - bpb\_hitdelay, 186
    - bpb\_info, 186
    - BPB\_LEN, 186
    - bpb\_missdelay, 186
    - BPB\_PSTATES, 186
    - bpb\_sbp\_bf\_fwd, 186
    - bpb\_sbp\_bnf\_fwd, 186
    - bpb\_update, 186
    - BPB\_USTATES, 186
    - BPB\_WAYS, 186

- btic, 187
- BTIC\_BLOCKSIZE, 186
- btic\_info, 186
- BTIC\_LEN, 186
- btic\_update, 186
- BTIC\_USTATES, 186
- BTIC\_WAYS, 186
- reg\_bpb\_sec, 186
- branch-predict.h
  - bpb\_info, 189
  - bpb\_update, 189
  - btic\_info, 189
  - btic\_update, 189
  - reg\_bpb\_sec, 189
- branch\_index
  - verilog.c, 511
- branchstat, 32
  - backward, 32
  - forward, 32
  - nottaken, 32
  - taken, 32
- breakpoint
  - execute.c, 375
- breakpoint\_entry, 33
  - addr, 33
  - next, 33
- breakpoints
  - labels.c, 269
  - labels.h, 271
- bsize
  - COFF\_AOUTHDR, 40
- btic
  - branch-predict.c, 187
  - config, 55
  - mstats\_entry, 156
- BTIC\_BLOCKSIZE
  - branch-predict.c, 186
- btic\_entry, 34
  - addr, 34
  - insn, 34
  - lru, 34
  - way, 34
- btic\_info
  - branch-predict.c, 186
  - branch-predict.h, 189
- BTIC\_LEN
  - branch-predict.c, 186
- btic\_update
  - branch-predict.c, 186
  - branch-predict.h, 189
- BTIC\_USTATES
  - branch-predict.c, 186
- BTIC\_WAYS
  - branch-predict.c, 186
- bticstat, 35
  - hit, 35
  - miss, 35
- buf
  - kbd\_state, 144
- buf\_count
  - kbd\_state, 144
- buf\_head
  - kbd\_state, 144
- BUF\_SIZE
  - mprofiler.c, 590
- buf\_tail
  - kbd\_state, 144
- build\_automata
  - or32.c, 432
- build\_bb
  - bb.c, 443
  - cuc.h, 470
- build\_insn
  - load.c, 495
- byte\_enabled
  - dev\_generic, 77
- byteadd
  - mstats\_entry, 156
- bytes\_left
  - eth\_device, 113
- BYTES\_PER\_SECTOR
  - atadevice-cmdi.h, 636
- bytes\_read
  - eth\_device, 113
- bytes\_sent
  - eth\_device, 113
- C\_ALIAS
  - coff.h, 249
- C\_ARG
  - coff.h, 249
- C\_AUTO
  - coff.h, 249
- C\_AUTOARG
  - coff.h, 249
- C\_BCOMM
  - coff.h, 249
- C\_BINCL
  - coff.h, 249
- C\_BLOCK
  - coff.h, 249
- C\_BSTAT
  - coff.h, 249
- C\_DECL
  - coff.h, 249
- C\_DEFINE
  - coff.h, 249
- C\_ECOML

- [coff.h](#), [249](#)
- C\_ECOMM
  - [coff.h](#), [249](#)
- C\_EFCN
  - [coff.h](#), [249](#)
- C\_EINCL
  - [coff.h](#), [249](#)
- C\_ENTAG
  - [coff.h](#), [249](#)
- C\_ENTRY
  - [coff.h](#), [249](#)
- C\_EOS
  - [coff.h](#), [249](#)
- C\_ESTAT
  - [coff.h](#), [249](#)
- C\_EXT
  - [coff.h](#), [249](#)
- C\_EXTDEF
  - [coff.h](#), [249](#)
- C\_EXTLAB
  - [coff.h](#), [249](#)
- C\_FCNC
  - [coff.h](#), [249](#)
- C\_FIELD
  - [coff.h](#), [249](#)
- C\_FILE
  - [coff.h](#), [249](#)
- c\_file\_head
  - [dyngen.c](#), [363](#)
- C\_FUN
  - [coff.h](#), [249](#)
- C\_GSYM
  - [coff.h](#), [249](#)
- C\_HIDDEN
  - [coff.h](#), [249](#)
- C\_HIDEXT
  - [coff.h](#), [249](#)
- C\_LABEL
  - [coff.h](#), [249](#)
- C\_LASTENT
  - [coff.h](#), [249](#)
- C\_LEAFEXT
  - [coff.h](#), [249](#)
- C\_LEAFPROC
  - [coff.h](#), [249](#)
- C\_LEAFSTAT
  - [coff.h](#), [249](#)
- C\_LINE
  - [coff.h](#), [249](#)
- C\_LSYM
  - [coff.h](#), [249](#)
- C\_MOE
  - [coff.h](#), [249](#)
- C\_MOS
  - [coff.h](#), [249](#)
- [coff.h](#), [249](#)
- C\_MOU
  - [coff.h](#), [249](#)
- C\_NT\_WEAK
  - [coff.h](#), [249](#)
- C\_NULL
  - [coff.h](#), [249](#)
- C\_OPTVAR
  - [coff.h](#), [249](#)
- C\_PRAGMA
  - [coff.h](#), [249](#)
- C\_PSYM
  - [coff.h](#), [249](#)
- C\_REG
  - [coff.h](#), [249](#)
- C\_REGPARAM
  - [coff.h](#), [249](#)
- c\_rel\_file\_head
  - [dyngen.c](#), [363](#)
- c\_rel\_file\_tail
  - [dyngen.c](#), [363](#)
- C\_RPSYM
  - [coff.h](#), [249](#)
- C\_RSYM
  - [coff.h](#), [249](#)
- C\_SCALL
  - [coff.h](#), [249](#)
- C\_SECTION
  - [coff.h](#), [249](#)
- C\_SEGMENT
  - [coff.h](#), [249](#)
- C\_SHADOW
  - [coff.h](#), [249](#)
- C\_STAT
  - [coff.h](#), [249](#)
- C\_STATLAB
  - [coff.h](#), [249](#)
- C\_STRTAG
  - [coff.h](#), [249](#)
- C\_STSYM
  - [coff.h](#), [249](#)
- c\_sw\_file\_head
  - [dyngen.c](#), [363](#)
- c\_sw\_file\_tail
  - [dyngen.c](#), [364](#)
- C\_SYSTEM
  - [coff.h](#), [249](#)
- C\_TCSYM
  - [coff.h](#), [249](#)
- C\_THUMBEXT
  - [coff.h](#), [249](#)
- C\_THUMBEXTFUNC
  - [coff.h](#), [249](#)
- C\_THUMBLABEL

- coff.h, 249
- C\_THUMBSTAT
  - coff.h, 249
- C\_THUMBSTATFUNC
  - coff.h, 249
- C\_TPDEF
  - coff.h, 249
- C\_UEXT
  - coff.h, 249
- C\_ULABEL
  - coff.h, 249
- C\_UNTAG
  - coff.h, 249
- C\_USTATIC
  - coff.h, 249
- C\_VERSION
  - coff.h, 249
- C\_WEAKEXT
  - coff.h, 249
- cache/dcache-model.c, 190
- cache/dcache-model.h, 195
- cache/icache-model.c, 198
- cache/icache-model.h, 203
- cachestats\_entry, 36
  - readhit, 36
  - readmiss, 36
  - writehit, 36
  - writemiss, 36
- calc\_cycles
  - cuc.c, 452
- calc\_max
  - adv.c, 441
- calc\_size
  - cuc.c, 452
- calculate\_watchpoints
  - debug-unit.c, 516
- caller\_saved
  - cuc.c, 462
  - cuc.h, 481
- calling\_convention
  - config, 55
- calls
  - func\_struct, 122
- cam\_addr
  - fb\_state, 118
- CAM\_SIZEX
  - fb.c, 717
- CAM\_SIZEY
  - fb.c, 717
- camera\_pos
  - fb\_state, 118
- camerax
  - fb\_state, 118
- cameray
  - fb\_state, 118
- ccmd
  - kbd\_state, 144
- ccmdbyte
  - kbd\_state, 144
- ce
  - mem\_config, 150
- CFA\_DISABLE\_8BIT\_PIO\_TRANSFER\_MODE
  - atacmd.h, 627
- CFA\_DISABLE\_POWER\_MODE1
  - atacmd.h, 627
- CFA\_ENABLE\_8BIT\_PIO\_TRANSFER\_MODE
  - atacmd.h, 627
- CFA\_ENABLE\_POWER\_MODE1
  - atacmd.h, 627
- CFA\_ERASE\_SECTORS
  - atacmd.h, 627
- CFA\_REQUEST\_EXTENDED\_ERROR\_CODE
  - atacmd.h, 627
- CFA\_TRANSLATE\_SECTOR
  - atacmd.h, 627
- CFA\_WRITE\_MULTIPLE\_WITHOUT\_ERASE
  - atacmd.h, 627
- CFA\_WRITE\_SECTORS\_WITHOUT\_ERASE
  - atacmd.h, 627
- ch
  - dma\_controller, 84
- chain
  - jtr\_chain\_message, 133
- change\_buf\_addr
  - fb.c, 718
- change\_insn\_type
  - insn.c, 484
  - insn.h, 492
- channel, 37
  - data, 37
  - dev\_16450, 74
  - ops, 37
- channel.c
  - channel\_close, 664
  - channel\_init, 664
  - channel\_open, 664
  - channel\_read, 664
  - channel\_write, 664
  - find\_channel\_factory, 664
  - head, 664
  - preloaded, 664
- channel.h
  - channel\_close, 665
  - channel\_init, 665
  - channel\_open, 665
  - channel\_read, 665
  - channel\_write, 665
- channel\_close

- channel.c, 664
- channel.h, 665
- channel\_factory, 38
  - name, 38
  - next, 38
  - ops, 38
- channel\_init
  - channel.c, 664
  - channel.h, 665
- channel\_mask
  - dma\_channel, 81
- CHANNEL\_ND\_I
  - dma.c, 692
- channel\_number
  - dma\_channel, 81
- channel\_open
  - channel.c, 664
  - channel.h, 665
- channel\_ops, 39
  - close, 39
  - free, 39
  - init, 39
  - isok, 39
  - open, 39
  - read, 39
  - status, 39
  - write, 39
- channel\_read
  - channel.c, 664
  - channel.h, 665
- channel\_str
  - dev\_16450, 74
- channel\_write
  - channel.c, 664
  - channel.h, 665
- channels/generic.c
  - generic\_close, 730
  - generic\_free, 730
  - generic\_open, 730
- channels/generic.h
  - generic\_close, 732
  - generic\_free, 732
  - generic\_open, 732
- char\_clks
  - 16450.c, 607
  - dev\_16450, 74
- check\_debug\_unit
  - debug-unit.c, 516
  - debug-unit.h, 525
- check\_depend
  - execute.c, 368
- check\_dma\_ack\_o
  - dma.c, 692
  - dma.h, 698
- check\_insn\_exec
  - sim-cmd.c, 788
- check\_int
  - toplevel-support.c, 855
  - toplevel-support.h, 860
- CHECK\_INT\_TIME
  - sim-config.h, 813
- check\_memory\_conflict
  - cuc/memory.c, 500
- CHECK\_POWER\_MODE
  - atacmd.h, 627
- chunk\_size
  - dma\_channel, 81
- class\_ptr
  - config, 55
- clean\_deps
  - cuc.h, 471
  - cuc/memory.c, 500
- clear\_dma\_nd\_i
  - dma.c, 692
  - dma.h, 698
- clear\_dma\_req\_i
  - dma.c, 692
  - dma.h, 698
- CLEAR\_FLAG
  - fields.h, 723
- clear\_interrupt
  - pic.c, 769
  - pic.h, 772
- client\_fd
  - rsp-server.c, 559
- client\_waiting
  - rsp-server.c, 559
- clkcycle\_ps
  - config, 55
- close
  - channel\_ops, 39
- close\_obj
  - bff, 28
- cmatch
  - \_csm\_list, 14
  - cuc\_shared\_item, 67
- cmd\_handle
  - sim\_command, 169
- cmov\_needed
  - insn.c, 484
- cmovs
  - \_csm\_list, 14
- cnt
  - \_csm\_list, 14
  - cuc\_bb, 63
  - memory\_hash, 153
- cnt\_dynamic
  - dstats\_entry, 88

- fstats\_entry, 121
- sstats\_entry, 174
- CNV16
  - fb.c, 717
- CNV32
  - fb.c, 717
- code
  - ps2kbd.c, 759
- coff.h
  - C\_ALIAS, 249
  - C\_ARG, 249
  - C\_AUTO, 249
  - C\_AUTOARG, 249
  - C\_BCOMM, 249
  - C\_BINCL, 249
  - C\_BLOCK, 249
  - C\_BSTAT, 249
  - C\_DECL, 249
  - C\_DEFINE, 249
  - C\_ECOML, 249
  - C\_ECOMM, 249
  - C\_EFCN, 249
  - C\_EINCL, 249
  - C\_ENTAG, 249
  - C\_ENTRY, 249
  - C\_EOS, 249
  - C\_ESTAT, 249
  - C\_EXT, 249
  - C\_EXTDEF, 249
  - C\_EXTLAB, 249
  - C\_FCN, 249
  - C\_FIELD, 249
  - C\_FILE, 249
  - C\_FUN, 249
  - C\_GSYM, 249
  - C\_HIDDEN, 249
  - C\_HIDEEXT, 249
  - C\_LABEL, 249
  - C\_LASTENT, 249
  - C\_LEAFEXT, 249
  - C\_LEAFPROC, 249
  - C\_LEAFSTAT, 249
  - C\_LINE, 249
  - C\_LSYM, 249
  - C\_MOE, 249
  - C\_MOS, 249
  - C\_MOU, 249
  - C\_NT\_WEAK, 249
  - C\_NULL, 249
  - C\_OPTVAR, 249
  - C\_PRAGMA, 249
  - C\_PSYM, 249
  - C\_REG, 249
  - C\_REGPARM, 249
  - C\_RPSYM, 249
  - C\_RSYM, 249
  - C\_SCALL, 249
  - C\_SECTION, 249
  - C\_SEGMENT, 249
  - C\_SHADOW, 249
  - C\_STAT, 249
  - C\_STATLAB, 249
  - C\_STRTAG, 249
  - C\_STSYM, 249
  - C\_SYSTEM, 249
  - C\_TCSYM, 249
  - C\_THUMBEXT, 249
  - C\_THUMBEXTFUNC, 249
  - C\_THUMBLABEL, 249
  - C\_THUMBSTAT, 249
  - C\_THUMBSTATFUNC, 249
  - C\_TPDEF, 249
  - C\_UEXT, 249
  - C\_ULABEL, 249
  - C\_UNTAG, 249
  - C\_USTATIC, 249
  - C\_VERSION, 249
  - C\_WEAKEXT, 249
  - COFF\_AOUTSZ, 249
  - COFF\_AUXENT, 249
  - COFF\_AUXESZ, 249
  - COFF\_BSS, 249
  - COFF\_COMMENT, 249
  - COFF\_DATA, 249
  - COFF\_DEF\_BSS\_SECTION\_ALIGNMENT, 249
  - COFF\_DEF\_DATA\_SECTION\_ALIGNMENT, 249
  - COFF\_DEF\_SECTION\_ALIGNMENT, 249
  - COFF\_DEF\_TEXT\_SECTION\_ALIGNMENT, 249
  - COFF\_DMAGIC, 249
  - COFF\_E\_DIMNUM, 249
  - COFF\_E\_FILNMLEN, 249
  - COFF\_E\_SYMNMLEN, 249
  - COFF\_ETEXT, 249
  - COFF\_F\_AR16WR, 249
  - COFF\_F\_AR32W, 249
  - COFF\_F\_AR32WR, 249
  - COFF\_F\_EXEC, 249
  - COFF\_F\_LNNO, 249
  - COFF\_F\_LSYMS, 249
  - COFF\_F\_MINMAL, 249
  - COFF\_F\_NODEF, 249
  - COFF\_F\_PATCH, 249
  - COFF\_F\_RELFLG, 249
  - COFF\_F\_SWABD, 249
  - COFF\_F\_UPDATE, 249

- COFF\_FILHDR, 249
- COFF\_FILHSZ, 249
- COFF\_I386BADMAG, 249
- COFF\_I386MAGIC, 249
- COFF\_JMAGIC, 249
- COFF\_LIB, 249
- COFF\_LINENO, 249
- COFF\_LINESZ, 249
- COFF\_LONG, 249
- COFF\_LONG\_H, 249
- COFF\_LONG\_L, 249
- COFF\_N\_BTMASK, 249
- COFF\_N\_BTSHFT, 249
- COFF\_N\_TMASK, 249
- COFF\_N\_TSHIFT, 249
- COFF\_OMAGIC, 249
- COFF\_RELOC, 249
- COFF\_RELSZ, 249
- COFF\_SCNHDR, 249
- COFF\_SCNHSZ, 249
- COFF\_SECT\_BSS, 249
- COFF\_SECT\_DATA, 249
- COFF\_SECT\_REQD, 249
- COFF\_SECT\_TEXT, 249
- COFF\_SHMAGIC, 249
- COFF\_SHORT, 249
- COFF\_SHORT\_H, 249
- COFF\_SHORT\_L, 249
- COFF\_SLIBHD, 249
- COFF\_SLIBSZ, 249
- COFF\_STMAGIC, 249
- COFF\_STYP\_BSS, 249
- COFF\_STYP\_COPY, 249
- COFF\_STYP\_DATA, 249
- COFF\_STYP\_DSECT, 249
- COFF\_STYP\_GROUP, 249
- COFF\_STYP\_INFO, 249
- COFF\_STYP\_LIB, 249
- COFF\_STYP\_NOLOAD, 249
- COFF\_STYP\_OVER, 249
- COFF\_STYP\_PAD, 249
- COFF\_STYP\_REG, 249
- COFF\_STYP\_TEXT, 249
- COFF\_SYMENT, 249
- COFF\_SYMESZ, 249
- COFF\_TEXT, 249
- COFF\_ZMAGIC, 249
- E\_DIMNUM, 249
- E\_FILNMLEN, 249
- E\_SYMNMLEN, 249
- KEEP\_ENDIAN\_LONG, 249
- KEEP\_ENDIAN\_SHORT, 250
- SWAP\_ENDIAN\_LONG, 250
- SWAP\_ENDIAN\_SHORT, 250
- COFF\_AOUTHDR, 40
  - bsize, 40
  - data\_start, 40
  - dsiz, 40
  - entry, 40
  - magic, 40
  - text\_start, 40
  - tsiz, 40
  - vstamp, 40
- COFF\_AOUTSZ
  - coff.h, 249
- COFF\_AUXENT
  - coff.h, 249
- COFF\_auxent, 41
  - x\_ary, 43
  - x\_dimen, 43
  - x\_endndx, 43
  - x\_fcn, 43
  - x\_fcny, 43
  - x\_file, 43
  - x\_fname, 43
  - x\_fsize, 43
  - x\_inno, 43
  - x\_innoptr, 43
  - x\_lnsz, 43
  - x\_misc, 43
  - x\_n, 43
  - x\_nlinno, 43
  - x\_nreloc, 43
  - x\_offset, 43
  - x\_scn, 43
  - x\_scnlen, 43
  - x\_size, 43
  - x\_sym, 43
  - x\_tagndx, 43
  - x\_tv, 43
  - x\_tvfill, 43
  - x\_tvlen, 43
  - x\_tvndx, 43
  - x\_tvrn, 43
  - x\_zeroes, 43
- COFF\_AUXESZ
  - coff.h, 249
- COFF\_BSS
  - coff.h, 249
- COFF\_COMMENT
  - coff.h, 249
- COFF\_DATA
  - coff.h, 249
- COFF\_DEF\_BSS\_SECTION\_ALIGNMENT
  - coff.h, 249
- COFF\_DEF\_DATA\_SECTION\_ALIGNMENT
  - coff.h, 249
- COFF\_DEF\_SECTION\_ALIGNMENT

- coff.h, 249
- COFF\_DEF\_TEXT\_SECTION\_ALIGNMENT
  - coff.h, 249
- COFF\_DMAGIC
  - coff.h, 249
- COFF\_E\_DIMNUM
  - coff.h, 249
- COFF\_E\_FILNMLEN
  - coff.h, 249
- COFF\_E\_SYMNMLEN
  - coff.h, 249
- COFF\_ETEXT
  - coff.h, 249
- COFF\_F\_AR16WR
  - coff.h, 249
- COFF\_F\_AR32W
  - coff.h, 249
- COFF\_F\_AR32WR
  - coff.h, 249
- COFF\_F\_EXEC
  - coff.h, 249
- COFF\_F\_LNNO
  - coff.h, 249
- COFF\_F\_LSYMS
  - coff.h, 249
- COFF\_F\_MINMAL
  - coff.h, 249
- COFF\_F\_NODF
  - coff.h, 249
- COFF\_F\_PATCH
  - coff.h, 249
- COFF\_F\_RELFLG
  - coff.h, 249
- COFF\_F\_SWABD
  - coff.h, 249
- COFF\_F\_UPDATE
  - coff.h, 249
- COFF\_filehdr, 45
  - f\_flags, 45
  - f\_magic, 45
  - f\_nscns, 45
  - f\_nsyms, 45
  - f\_opthdr, 45
  - f\_symptr, 45
  - f\_timdat, 45
- COFF\_FILHDR
  - coff.h, 249
- COFF\_FILHSZ
  - coff.h, 249
- COFF\_I386BADMAG
  - coff.h, 249
- COFF\_I386MAGIC
  - coff.h, 249
- COFF\_JMAGIC
  - coff.h, 249
- COFF\_LIB
  - coff.h, 249
- COFF\_LINENO
  - coff.h, 249
- COFF\_lineno, 46
  - l\_addr, 46
  - l\_inno, 46
  - l\_paddr, 46
  - l\_symndx, 46
- COFF\_LINESZ
  - coff.h, 249
- COFF\_LONG
  - coff.h, 249
- COFF\_LONG\_H
  - coff.h, 249
- COFF\_LONG\_L
  - coff.h, 249
- COFF\_N\_BTMASK
  - coff.h, 249
- COFF\_N\_BTSHFT
  - coff.h, 249
- COFF\_N\_TMASK
  - coff.h, 249
- COFF\_N\_TSHIFT
  - coff.h, 249
- COFF\_OMAGIC
  - coff.h, 249
- COFF\_RELOC
  - coff.h, 249
- COFF\_reloc, 47
  - r\_symndx, 47
  - r\_type, 47
  - r\_vaddr, 47
- COFF\_RELSZ
  - coff.h, 249
- COFF\_SCNHDR
  - coff.h, 249
- COFF\_scnhdr, 48
  - s\_flags, 48
  - s\_innoptr, 48
  - s\_name, 48
  - s\_nlnno, 48
  - s\_nreloc, 48
  - s\_paddr, 48
  - s\_relptr, 48
  - s\_scnptr, 48
  - s\_size, 48
  - s\_vaddr, 48
- COFF\_SCNHSZ
  - coff.h, 249
- COFF\_SECT\_BSS
  - coff.h, 249
- COFF\_SECT\_DATA



- coff.h, 249
- COFF\_SECT\_REQD
  - coff.h, 249
- COFF\_SECT\_TEXT
  - coff.h, 249
- COFF\_SHMAGIC
  - coff.h, 249
- COFF\_SHORT
  - coff.h, 249
- COFF\_SHORT\_H
  - coff.h, 249
- COFF\_SHORT\_L
  - coff.h, 249
- COFF\_slib, 49
  - sl\_entsz, 49
  - sl\_pathndx, 49
- COFF\_SLIBHD
  - coff.h, 249
- COFF\_SLIBSZ
  - coff.h, 249
- COFF\_STMAGIC
  - coff.h, 249
- COFF\_STYP\_BSS
  - coff.h, 249
- COFF\_STYP\_COPY
  - coff.h, 249
- COFF\_STYP\_DATA
  - coff.h, 249
- COFF\_STYP\_DSECT
  - coff.h, 249
- COFF\_STYP\_GROUP
  - coff.h, 249
- COFF\_STYP\_INFO
  - coff.h, 249
- COFF\_STYP\_LIB
  - coff.h, 249
- COFF\_STYP\_NOLOAD
  - coff.h, 249
- COFF\_STYP\_OVER
  - coff.h, 249
- COFF\_STYP\_PAD
  - coff.h, 249
- COFF\_STYP\_REG
  - coff.h, 249
- COFF\_STYP\_TEXT
  - coff.h, 249
- COFF\_SYMENT
  - coff.h, 249
- COFF\_syment, 50
  - e, 50
  - e\_name, 50
  - e\_numaux, 50
  - e\_offset, 50
  - e\_sclass, 50
  - e\_scnun, 50
  - e\_type, 50
  - e\_value, 50
  - e\_zeroes, 50
- COFF\_SYMESZ
  - coff.h, 249
- COFF\_TEXT
  - coff.h, 249
- COFF\_ZMAGIC
  - coff.h, 249
- collconf
  - eth\_device, 113
- command
  - ata\_device, 22
  - jtr\_chain\_message, 133
  - jtr\_read\_block\_message, 136
  - jtr\_read\_message, 138
  - jtr\_write\_block\_message, 140
  - jtr\_write\_message, 142
- common-i386.h
  - get\_pc, 325
  - high32, 325
  - low32, 325
  - set\_pc, 325
  - upd\_sim\_cycles, 325
  - useless\_x86, 325
  - val3232, 325
  - val64, 325
- COMP
  - op.c, 423
- COMP\_CAST
  - op.c, 423
- COMP\_NAME
  - op.c, 423
- compression
  - INFOHEADER, 131
- comutative
  - cuc\_known\_insn, 66
- conf
  - ata\_device, 22
- conf\_dev
  - atahost.c, 656
- config, 51
  - blocksize, 55
  - bpb, 55
  - btic, 55
  - calling\_convention, 55
  - class\_ptr, 55
  - clkcycle\_ps, 55
  - cpu, 55
  - cuc, 55
  - dc, 55
  - debug, 55
  - dependstats, 55

- enable\_bursts, 55
- enabled, 55
- exe\_log, 55
- exe\_log\_end, 55
- exe\_log\_fn, 55
- exe\_log\_marker, 55
- exe\_log\_start, 55
- exe\_log\_type, 55
- ext, 55
- gdb\_enabled, 55
- hazards, 55
- hide\_device\_id, 55
- history, 55
- hitdelay, 55
- load\_hitdelay, 55
- load\_missdelay, 55
- log\_enabled, 55
- memory\_order, 55
- missdelay, 55
- mprof\_fn, 55
- mprofile, 55
- no\_multicycle, 55
- nsets, 55
- nways, 55
- pic, 55
- pm, 55
- prof\_fn, 55
- profile, 55
- read\_up, 55
- rsp\_enabled, 55
- rsp\_port, 55
- sbp\_bf\_fwd, 55
- sbp\_bnf\_fwd, 55
- sbuf\_len, 55
- server\_port, 55
- sim, 55
- sim-config.c, 811
- sim-config.h, 817
- store\_hitdelay, 55
- store\_missdelay, 55
- strict\_npc, 55
- superscalar, 55
- timings\_fn, 55
- ustates, 55
- vapi, 55
- vapi\_fn, 55
- vapi\_id, 55
- verbose, 55
- write\_up, 55
- config::pic, 57
  - edge\_trigger, 57
  - enabled, 57
- config\_param, 58
  - func, 58
  - name, 58
  - next, 58
  - type, 58
- config\_section, 59
  - dat, 59
  - name, 59
  - next, 59
  - params, 59
  - sec\_end, 59
  - sec\_start, 59
- connected
  - tcp\_channel, 176
- controller
  - dma\_channel, 81
- controlmoder
  - eth\_device, 113
- conv
  - load.c, 498
- correct
  - bpbstat, 31
- count\_bb\_seq
  - bb.c, 443
- count\_cmovs
  - insn.c, 484
- cover\_insn
  - or32.c, 432
- cpu
  - config, 55
  - runtime, 165
- cpu-config.c, 206
  - cpu\_cfg, 207
  - cpu\_cfg, 207
  - cpu\_dependstats, 207
  - cpu\_hazards, 207
  - cpu\_rev, 207
  - cpu\_sbuf\_len, 207
  - cpu\_sr, 207
  - cpu\_superscalar, 208
  - cpu\_upr, 208
  - cpu\_ver, 208
  - reg\_cpu\_sec, 208
  - WARNING, 207
- cpu-config.h, 210
  - reg\_cpu\_sec, 210
- cpu/common/abstract.c, 211
- cpu/common/abstract.h, 229
- cpu/common/coff.h, 244
- cpu/common/elf.h, 251
- cpu/common/execute.h, 261
- cpu/common/labels.c, 268
- cpu/common/labels.h, 270
- cpu/common/parse.c, 272
- cpu/common/parse.h, 278
- cpu/common/stats.c, 280

- cpu/common/stats.h, 284
- cpu/common/trace.c, 286
- cpu/common/trace.h, 288
- cpu/or1k/arch.h, 290
- cpu/or1k/except.c, 292
- cpu/or1k/except.h, 294
- cpu/or1k/spr-defs.h, 298
- cpu/or1k/spr-dump.c, 308
- cpu/or1k/spr-dump.h, 320
- cpu/or1k/sprs.c, 321
- cpu/or1k/sprs.h, 323
- cpu/or32/common-i386.h, 325
- cpu/or32/def-op-t.h, 326
- cpu/or32/dyn-rec.c, 328
- cpu/or32/dyn-rec.h, 352
- cpu/or32/dyn32-defs.h, 357
- cpu/or32/dyngen-elf.c, 358
- cpu/or32/dyngen-i386.c, 360
- cpu/or32/dyngen.c, 362
- cpu/or32/dyngen.h, 365
- cpu/or32/execute.c, 366
- cpu/or32/generate.c, 377
- cpu/or32/i386-regs.h, 380
- cpu/or32/insnset.c, 381
- cpu/or32/op-1t-op.h, 393
- cpu/or32/op-1t.h, 394
- cpu/or32/op-2t-op.h, 395
- cpu/or32/op-2t.h, 396
- cpu/or32/op-3t-op.h, 397
- cpu/or32/op-3t.h, 398
- cpu/or32/op-arith-op.h, 399
- cpu/or32/op-comp-op.h, 400
- cpu/or32/op-extend-op.h, 401
- cpu/or32/op-ff1-op.h, 402
- cpu/or32/op-i386.h, 403
- cpu/or32/op-lwhb-op.h, 404
- cpu/or32/op-mac-op.h, 405
- cpu/or32/op-mftspr-op.h, 406
- cpu/or32/op-support.c, 407
- cpu/or32/op-support.h, 409
- cpu/or32/op-swhb-op.h, 411
- cpu/or32/op-t-reg-mov-op.h, 412
- cpu/or32/op.c, 416
- cpu/or32/or32.c, 430
- cpu/or32/rec-i386.h, 437
- cpu/or32/sched-i386.h, 438
- cpu/or32/simpl32-defs.h, 439
- cpu\_cfg
  - cpu-config.c, 207
- cpu\_cfgr
  - cpu-config.c, 207
- cpu\_clock
  - execute.c, 368
  - execute.h, 262
- cpu\_dependstats
  - cpu-config.c, 207
- cpu\_hazards
  - cpu-config.c, 207
- cpu\_reset
  - execute.c, 369
  - execute.h, 263
- cpu\_rev
  - cpu-config.c, 207
- cpu\_sbuf\_len
  - cpu-config.c, 207
- cpu\_sr
  - cpu-config.c, 207
- cpu\_state, 60
  - delay\_insn, 60
  - execute.c, 375
  - execute.h, 267
  - icomplet, 60
  - insn\_ea, 60
  - iqueue, 61
  - npc\_not\_valid, 61
  - pc, 61
  - pc\_delay, 61
  - pic\_lines, 61
  - reg, 61
  - sprs, 61
- CPU\_STATE\_REG
  - i386-regs.h, 380
- cpu\_superscalar
  - cpu-config.c, 208
- cpu\_upr
  - cpu-config.c, 208
- cpu\_ver
  - cpu-config.c, 208
- cpy\_bb
  - bb.c, 443
- crc32
  - crc32.c, 681
  - crc32.h, 682
- crc32.c
  - crc32, 681
  - crc32\_close, 681
  - crc32\_feed\_bytes, 681
  - crc32\_init, 681
  - crc32\_table, 681
- crc32.h
  - crc32, 682
  - crc32\_close, 682
  - crc32\_feed\_bytes, 682
  - crc32\_init, 682
- crc32\_close
  - crc32.c, 681
  - crc32.h, 682
- crc32\_feed\_bytes

- crc32.c, 681
  - crc32.h, 682
- crc32\_init
  - crc32.c, 681
  - crc32.h, 682
- crc32\_table
  - crc32.c, 681
- crc\_dly
  - eth\_device, 113
- crc\_value
  - eth\_device, 113
- cs
  - mc\_area, 148
- csc
  - mc, 147
- cse
  - cuc.h, 471
  - insn.c, 484
- csm
  - cuc.h, 471
  - insn.c, 484
- csm\_gen
  - cuc.h, 471
  - insn.c, 484
- csr
  - dma\_channel, 81
  - dma\_controller, 84
  - mc, 147
- CT\_NONE
  - abstract.h, 231
- CT\_PHYSICAL
  - abstract.h, 231
- CT\_VIRTUAL
  - abstract.h, 231
- ctrl
  - ata\_host, 26
  - fb\_state, 118
  - gpio\_device, 124
  - vga\_state, 180
- ctrl\_c
  - toplevel-support.c, 856
  - toplevel-support.h, 861
- cuc
  - config, 55
  - runtime, 165
- cuc.c
  - analyse\_function, 451
  - calc\_cycles, 452
  - calc\_size, 452
  - caller\_saved, 462
  - cuc\_calling\_conv, 452
  - cuc\_debug, 463
  - cuc\_enable\_bursts, 452
  - cuc\_memory\_order, 452
  - cuc\_no\_multicycle, 452
  - cuc\_optimize, 453
  - cuc\_timings\_fn, 453
  - extract\_function, 454
  - flog, 463
  - format\_func\_options, 454
  - func, 463
  - func\_v, 463
  - gen\_option, 454
  - generate\_function, 456
  - main\_cuc, 457
  - option\_char, 463
  - options\_cmd, 459
  - preunroll\_bb, 459
  - print\_option, 462
  - reg\_cuc\_sec, 462
  - set\_func\_deps, 462
  - tim\_comp, 462
- cuc.h
  - add\_data\_dep, 469
  - add\_dep, 470
  - add\_latches, 470
  - add\_memory\_dep, 470
  - analyse\_timings, 470
  - BB\_DEAD, 469
  - BB\_INLOOP, 469
  - BB\_OPTIONAL, 469
  - BBID\_END, 469
  - BBID\_START, 469
  - build\_bb, 470
  - caller\_saved, 481
  - clean\_deps, 471
  - cse, 471
  - csm, 471
  - csm\_gen, 471
  - cuc\_check, 471
  - cuc\_debug, 481
  - cuc\_func, 469
  - cuc\_load, 471
  - CUC\_MAX\_STACK, 469
  - cuc\_shared\_list, 469
  - CUC\_WIDTH\_ITERATIONS, 469
  - cucdebug, 469
  - dep\_list, 469
  - detect\_bb, 472
  - detect\_max\_values, 472
  - dispose\_list, 472
  - dup\_func, 473
  - expand\_bb, 473
  - FLAG\_REG, 469
  - flog, 481
  - free\_func, 473
  - generate\_bb\_seq, 473
  - insert\_conditional\_facts, 473

- insert\_insns, 474
- INSN, 469
- insn, 481
- IT\_BBEND, 469
- IT\_BBSTART, 469
- IT\_BRANCH, 469
- IT\_COND, 469
- IT\_CUT, 469
- IT\_FLAG1, 469
- IT\_FLAG2, 469
- IT\_INDELAY, 469
- IT\_LATCHED, 469
- IT\_MEMADD, 469
- IT\_MEMORY, 469
- IT\_OUTPUT, 469
- IT\_SIGNED, 469
- IT\_UNUSED, 469
- IT\_VOLATILE, 469
- log, 469
- LRBB\_REG, 469
- main\_cuc, 474
- mark\_cut, 477
- MAX, 469
- MAX\_BB, 469
- MAX\_INSNS, 469
- MAX\_PREROLL, 469
- MAX\_REGS, 469
- MAX\_UNROLL, 469
- MIN, 469
- MO\_EXACT, 469
- MO\_NONE, 469
- MO\_STRONG, 469
- MO\_WEAK, 469
- MT\_BURST, 469
- MT\_BURSTE, 469
- MT\_CALL, 469
- MT\_LOAD, 469
- MT\_SIGNED, 469
- MT\_STORE, 469
- MT\_WIDTH, 469
- negate\_conditional, 477
- num\_insn, 481
- OPT\_BB, 469
- OPT\_CONST, 469
- OPT\_DEST, 469
- OPT\_JUMP, 469
- OPT\_LRBB, 469
- OPT\_NONE, 469
- OPT\_REF, 469
- OPT\_REGISTER, 469
- optimize\_bb, 477
- optimize\_cmovs, 477
- optimize\_tree, 477
- preunroll\_loop, 478
- print\_bb\_num, 478
- print\_cuc\_bb, 478
- print\_cuc\_insns, 478
- print\_insns, 479
- recalc\_cnts, 479
- REF, 469
- REF\_BB, 469
- REF\_I, 469
- reg\_cuc\_sec, 479
- reg\_dep, 479
- reloc, 481
- remove\_dead, 480
- remove\_dead\_bb, 480
- remove\_nops, 480
- remove\_trivial\_regs, 480
- schedule\_memory, 480
- set\_io, 481
- cuc/adv.c, 440
- cuc/bb.c, 442
- cuc/cuc.c, 448
- cuc/cuc.h, 464
- cuc/insn.c, 482
- cuc/insn.h, 488
- cuc/load.c, 494
- cuc/memory.c, 499
  - add\_memory\_dep, 500
  - check\_memory\_conflict, 500
  - clean\_deps, 500
  - join\_transfers, 500
  - mem\_ordering\_cmp, 500
  - same\_transfers, 500
  - schedule\_memory, 500
- cuc/timings.c, 507
- cuc/verilog.c, 510
- cuc/verilog.h, 513
- cuc\_bb, 62
  - cnt, 63
  - first, 63
  - insn, 63
  - last, 63
  - last\_used\_reg, 63
  - mdep, 63
  - next, 63
  - ninsn, 63
  - nmemory, 63
  - ntim, 63
  - prev, 63
  - selected\_tim, 63
  - tim, 63
  - tmp, 63
  - type, 63
  - unrolled, 63
- cuc\_calling\_conv
  - cuc.c, 452

- cuc\_check
  - bb.c, 443
  - cuc.h, 471
- cuc\_conv, 64
  - from, 64
  - to, 64
- cuc\_debug
  - cuc.c, 463
  - cuc.h, 481
- cuc\_enable\_bursts
  - cuc.c, 452
- cuc\_func
  - cuc.h, 469
- cuc\_insn, 65
  - dep, 65
  - disasm, 65
  - index, 65
  - insn, 65
  - max, 65
  - op, 65
  - opt, 65
  - tmp, 65
  - type, 65
- cuc\_insn\_name
  - insn.c, 484
  - insn.h, 492
- cuc\_known\_insn, 66
  - comutative, 66
  - name, 66
  - rtl, 66
- cuc\_load
  - cuc.h, 471
  - load.c, 495
- CUC\_MAX\_STACK
  - cuc.h, 469
- cuc\_memory\_order
  - cuc.c, 452
- cuc\_no\_multicycle
  - cuc.c, 452
- cuc\_optimize
  - cuc.c, 453
- cuc\_shared\_item, 67
  - cmatch, 67
  - ref, 67
- cuc\_shared\_list
  - cuc.h, 469
- cuc\_timing\_table, 68
  - delay, 68
  - delayi, 68
  - size, 68
  - sizei, 68
- cuc\_timings, 69
  - b, 69
  - new\_time, 69
  - nshared, 69
  - preroll, 69
  - shared, 69
  - size, 69
  - unroll, 69
- cuc\_timings\_fn
  - cuc.c, 453
- CUC\_WIDTH\_ITERATIONS
  - cuc.h, 469
- cucdebug
  - cuc.h, 469
- cum\_cycles
  - func\_struct, 122
- cumulative
  - profiler.c, 782
- cur\_area
  - abstract.c, 228
  - abstract.h, 243
- cur\_section
  - sim-config.c, 811
  - sim-config.h, 817
- cur\_vadd
  - abstract.c, 228
- CURINSN
  - execute.h, 262
- curpass
  - or32.c, 435
- curr
  - gpio\_device, 124
- current\_descriptor
  - dma\_channel, 81
- current\_scan\_chain
  - debug-unit.c, 523
- cut\_tree
  - timings.c, 508
- cycle\_duration
  - runtime, 165
- cycles
  - runtime, 165
  - stack\_struct, 175
- cycles\_start
  - tick.c, 845
- cylinder\_high
  - ata\_device, 22
- cylinder\_low
  - ata\_device, 22
- d\_ptr
  - dynamic, 90
  - Elf64\_Dyn, 99
- d\_tag
  - dynamic, 90
  - Elf64\_Dyn, 99
- d\_un

- dynamic, 90
- Elf64\_Dyn, 99
- d\_val
  - dynamic, 90
  - Elf64\_Dyn, 99
- DADDR\_PAGE
  - dmmu.h, 579
- daspi
  - ata\_device, 22
- daspo
  - ata\_device, 22
- dat
  - config\_section, 59
  - sim\_reset\_hook, 170
  - sim\_stat, 171
- data
  - channel, 37
  - jtr\_read\_block\_response, 137
  - jtr\_write\_block\_message, 140
  - rsp\_buf, 162
- data\_ci
  - abstract.c, 228
  - abstract.h, 243
- data\_h
  - jtr\_read\_response, 139
  - jtr\_write\_message, 142
- data\_l
  - jtr\_read\_response, 139
  - jtr\_write\_message, 142
- data\_start
  - COFF\_AOUTHDR, 40
- dataport\_i
  - ata\_device, 22
- dbuf
  - ata\_device, 22
- dbuf\_cnt
  - ata\_device, 22
- dbuf\_ptr
  - ata\_device, 22
- dc
  - config, 55
  - dcache-model.c, 194
- dc\_blocksize
  - dcache-model.c, 191
- dc\_enabled
  - dcache-model.c, 191
- dc\_info
  - dcache-model.c, 191
  - dcache-model.h, 196
- dc\_inv
  - dcache-model.c, 191
  - dcache-model.h, 196
- dc\_load\_hitdelay
  - dcache-model.c, 191
- dc\_load\_missdelay
  - dcache-model.c, 191
- dc\_nsets
  - dcache-model.c, 191
- dc\_nways
  - dcache-model.c, 192
- dc\_set, 70
  - line, 70
  - lru, 70
  - tagaddr, 70
  - way, 70
- dc\_simulate\_read
  - dcache-model.c, 192
  - dcache-model.h, 196
- dc\_simulate\_write
  - dcache-model.c, 192
  - dcache-model.h, 196
- dc\_stats
  - stats.c, 282
  - stats.h, 285
- dc\_store\_hitdelay
  - dcache-model.c, 193
- dc\_store\_missdelay
  - dcache-model.c, 193
- dc\_ustates
  - dcache-model.c, 193
- dcache-model.c
  - dc, 194
  - dc\_blocksize, 191
  - dc\_enabled, 191
  - dc\_info, 191
  - dc\_inv, 191
  - dc\_load\_hitdelay, 191
  - dc\_load\_missdelay, 191
  - dc\_nsets, 191
  - dc\_nways, 192
  - dc\_simulate\_read, 192
  - dc\_simulate\_write, 192
  - dc\_store\_hitdelay, 193
  - dc\_store\_missdelay, 193
  - dc\_ustates, 193
  - reg\_dc\_sec, 193
- dcache-model.h
  - dc\_info, 196
  - dc\_inv, 196
  - dc\_simulate\_read, 196
  - dc\_simulate\_write, 196
  - MAX\_DC\_BLOCK\_SIZE, 196
  - MAX\_DC\_SETS, 196
  - MAX\_DC\_WAYS, 196
  - MIN\_DC\_BLOCK\_SIZE, 196
  - reg\_dc\_sec, 197
- dead
  - \_csm\_list, 14

- debug
  - config, 55
  - debug.c, 820
  - debug.h, 823
- debug-unit.c
  - calculate\_watchpoints, 516
  - check\_debug\_unit, 516
  - current\_scan\_chain, 523
  - debug\_enabled, 516
  - debug\_gdb\_enabled, 517
  - debug\_get\_mem, 517
  - debug\_get\_register, 517
  - debug\_ignore\_exception, 518
  - debug\_rsp\_enabled, 518
  - debug\_rsp\_port, 519
  - debug\_server\_port, 519
  - debug\_set\_chain, 519
  - debug\_set\_mem, 519
  - debug\_set\_register, 520
  - debug\_vapi\_id, 520
  - DEVELOPINT\_MAX, 516
  - DEVELOPINT\_RISCOP, 516
  - development, 523
  - development\_interface\_address\_space, 516
  - du\_reset, 521
  - get\_devint\_reg, 521
  - in\_reset, 523
  - reg\_debug\_sec, 521
  - RISCOP\_RESET, 515
  - RISCOP\_STALL, 515
  - set\_devint\_reg, 522
  - set\_stall\_state, 523
- debug-unit.h
  - check\_debug\_unit, 525
  - debug\_get\_register, 525
  - debug\_ignore\_exception, 526
  - debug\_scan\_chain\_ids, 524
  - debug\_set\_chain, 526
  - debug\_set\_register, 526
  - debug\_unit\_action, 524
  - DebugInstructionFetch, 525
  - DebugLoadAddress, 525
  - DebugLoadData, 525
  - DebugStoreAddress, 525
  - DebugStoreData, 525
  - du\_reset, 527
  - JTAG\_CHAIN\_DEBUG\_UNIT, 524
  - JTAG\_CHAIN\_DEVELOPMENT, 524
  - JTAG\_CHAIN\_GLOBAL, 524
  - JTAG\_CHAIN\_TRACE, 524
  - JTAG\_CHAIN\_WISHBONE, 524
  - reg\_debug\_sec, 527
  - set\_stall\_state, 528
- debug.c
  - \_\_ORSIM\_NO\_DEC\_DBCH, 820
  - \_\_orsim\_dbchs, 820
  - debug, 820
  - debug\_classes, 820
  - DECLARE\_DEBUG\_CHANNEL, 820
  - orsim\_dbcl\_set, 820
  - orsim\_dbcl\_set\_name, 820
  - orsim\_dbg\_log, 820
  - parse\_dbchs, 820
- debug.h
  - \_\_ORSIM\_DBCL\_ERR, 823
  - \_\_ORSIM\_DBCL\_FIXME, 823
  - \_\_ORSIM\_DBCL\_TRACE, 823
  - \_\_ORSIM\_DBCL\_WARN, 823
  - \_\_ORSIM\_DBG\_USE\_FUNC, 822
  - \_\_ORSIM\_DEBUG\_CLASS, 823
  - \_\_ORSIM\_DEBUG\_LOG, 822
  - \_\_ORSIM\_DPRINTF, 822
  - \_\_ORSIM\_GET\_DEBUGGING, 822
  - \_\_ORSIM\_GET\_DEBUGGING\_ERR, 822
  - \_\_ORSIM\_GET\_DEBUGGING\_FIXME, 822
  - \_\_ORSIM\_GET\_DEBUGGING\_TRACE, 822
  - \_\_ORSIM\_GET\_DEBUGGING\_WARN, 822
  - debug, 823
  - DECLARE\_DEBUG\_CHANNEL, 822
  - DEFAULT\_DEBUG\_CHANNEL, 822
  - ERR, 822
  - ERR\_, 823
  - ERR\_ON, 823
  - FIXME, 823
  - FIXME\_, 823
  - FIXME\_ON, 823
  - orsim\_dbcl\_set\_name, 823
  - orsim\_dbg\_log, 824
  - parse\_dbchs, 824
  - TRACE, 823
  - TRACE\_, 823
  - TRACE\_ON, 823
  - WARN, 823
  - WARN\_, 823
  - WARN\_ON, 823
- debug/debug-unit.c, 514
- debug/debug-unit.h, 524
- debug/gdb.h, 529
- debug/gdbcomm.c, 531
- debug/gdbcomm.h, 535
- debug/rsp-server.c, 537
- debug/rsp-server.h, 561
- debug\_classes
  - debug.c, 820
- debug\_enabled
  - debug-unit.c, 516
- debug\_gdb\_enabled
  - debug-unit.c, 517



- debug\_get\_mem
  - debug-unit.c, 517
- debug\_get\_register
  - debug-unit.c, 517
  - debug-unit.h, 525
- debug\_ignore\_exception
  - debug-unit.c, 518
  - debug-unit.h, 526
- debug\_rsp\_enabled
  - debug-unit.c, 518
- debug\_rsp\_port
  - debug-unit.c, 519
- debug\_scan\_chain\_ids
  - debug-unit.h, 524
- debug\_server\_port
  - debug-unit.c, 519
- debug\_set\_chain
  - debug-unit.c, 519
  - debug-unit.h, 526
- debug\_set\_mem
  - debug-unit.c, 519
- debug\_set\_register
  - debug-unit.c, 520
  - debug-unit.h, 526
- debug\_unit\_action
  - debug-unit.h, 524
- debug\_vapi\_id
  - debug-unit.c, 520
- DebugInstructionFetch
  - debug-unit.h, 525
- DebugLoadAddress
  - debug-unit.h, 525
- DebugLoadData
  - debug-unit.h, 525
- DebugStoreAddress
  - debug-unit.h, 525
- DebugStoreData
  - debug-unit.h, 525
- DECLARE\_DEBUG\_CHANNEL
  - debug.c, 820
  - debug.h, 822
  - sched.c, 836
  - sprs.c, 322
- decode\_execute
  - execute.c, 369
- decode\_execute\_wrapper
  - execute.c, 369
- def-op-t.h
  - DEF\_1T\_OP, 326
  - DEF\_2T\_OP, 326
  - DEF\_2T\_OP\_NEQ, 326
  - DEF\_3T\_OP, 326
  - DEF\_3T\_OP\_NEQ, 327
  - DEF\_GPR\_OP, 327
- GPR\_T, 327
- DEF\_1T\_OP
  - def-op-t.h, 326
  - dyn-rec.c, 335
- DEF\_2T\_OP
  - def-op-t.h, 326
  - dyn-rec.c, 335
- DEF\_2T\_OP\_NEQ
  - def-op-t.h, 326
  - dyn-rec.c, 335
- DEF\_3T\_OP
  - def-op-t.h, 326
  - dyn-rec.c, 335
- DEF\_3T\_OP\_NEQ
  - def-op-t.h, 327
  - dyn-rec.c, 335
- DEF\_GPR\_OP
  - def-op-t.h, 327
  - dyn-rec.c, 335
- DEFAULT\_BAUD
  - tty.c, 676
- DEFAULT\_DEBUG\_CHANNEL
  - debug.h, 822
- DEFAULT\_MEMORY\_LEN
  - abstract.h, 231
- DEFAULT\_MEMORY\_START
  - abstract.h, 231
- DEFAULT\_TTY\_DEVICE
  - tty.c, 676
- delay
  - cuc\_timing\_table, 68
- delay\_insn
  - cpu\_state, 60
- delayi
  - cuc\_timing\_table, 68
- delayr
  - dyn\_page, 89
  - mem\_config, 150
  - mem\_ops, 152
- delayw
  - mem\_config, 150
  - mem\_ops, 152
- dep
  - cuc\_insn, 65
- dep\_list
  - cuc.h, 469
- depend
  - dstats\_entry, 88
  - fstats\_entry, 121
- depend\_operands
  - execute.h, 263
- dependstats
  - config, 55
- desc

- dma\_channel, 81
- destination
  - dma\_channel, 81
- destination\_mask
  - dma\_channel, 81
- destruct\_automata
  - or32.c, 432
- detect\_bb
  - bb.c, 443
  - cuc.h, 472
- detect\_locals
  - load.c, 496
- detect\_max\_values
  - adv.c, 441
  - cuc.h, 472
- dev
  - ata\_device, 22
- dev\_generic
  - GENERIC\_BYTE, 76
  - GENERIC\_HW, 76
  - GENERIC\_READ, 76
  - GENERIC\_WORD, 76
  - GENERIC\_WRITE, 76
- dev\_16450, 71
  - baseaddr, 74
  - channel, 74
  - channel\_str, 74
  - char\_clks, 74
  - dlh, 74
  - dll, 74
  - enabled, 74
  - fcr, 74
  - fifo\_len, 74
  - ier, 74
  - iir, 74
  - ints, 74
  - iregs, 74
  - irq, 74
  - istat, 74
  - jitter, 74
  - lcr, 74
  - loopback, 74
  - lsr, 74
  - mcr, 74
  - msr, 74
  - receiveng, 74
  - recv\_break, 74
  - regs, 74
  - rxbuf, 74
  - rxbuf\_full, 74
  - rxbuf\_head, 74
  - rxbuf\_tail, 74
  - rxser, 74
  - scr, 74
  - skew, 74
  - txbuf, 74
  - txbuf\_full, 74
  - txbuf\_head, 74
  - txbuf\_tail, 74
  - txser, 74
  - uart16550, 74
  - vapi, 74
  - vapi\_buf, 74
  - vapi\_buf\_head\_ptr, 74
  - vapi\_buf\_tail\_ptr, 74
  - vapi\_id, 74
- dev\_generic, 76
  - baseaddr, 77
  - byte\_enabled, 77
  - enabled, 77
  - hw\_enabled, 77
  - name, 77
  - size, 77
  - trans\_direction, 77
  - trans\_size, 77
  - value, 77
  - word\_enabled, 77
- dev\_id
  - ata\_host, 26
- dev\_list
  - abstract.c, 228
- dev\_memarea, 78
  - addr\_compare, 79
  - addr\_mask, 79
  - direct\_ops, 79
  - log, 79
  - next, 79
  - ops, 79
  - size, 79
  - size\_mask, 79
  - valid, 79
- dev\_sel
  - ata\_host, 26
- DEVELOPINT\_MAX
  - debug-unit.c, 516
- DEVELOPINT\_RISCOPE
  - debug-unit.c, 516
- development
  - debug-unit.c, 523
- development\_interface\_address\_space
  - debug-unit.c, 516
- device
  - ata\_devices, 24
- device\_control
  - ata\_device, 22
- device\_head
  - ata\_device, 22
- DEVICE\_RESET

- atacmd.h, 627
- devices
  - ata\_host, 26
- direct\_ops
  - dev\_memarea, 79
- dirty
  - dyn\_page, 89
- dirtyfy\_page
  - dyn-rec.c, 335
- DISABLE\_ADVANCED\_POWER\_-  
MANAGEMENT
  - atacmd.h, 627
- DISABLE\_MEDIA\_STATUS\_NOTIFICATION
  - atacmd.h, 627
- DISABLE\_POWERUP\_IN\_STANDBY\_-  
FEATURE\_SET
  - atacmd.h, 627
- DISABLE\_READ\_LOOKAHEAD
  - atacmd.h, 627
- DISABLE\_RELEASE\_INTERRUPT
  - atacmd.h, 627
- DISABLE\_REVERTING\_TO\_POWERON\_-  
DEFAULTS
  - atacmd.h, 627
- DISABLE\_SERVICE\_INTERRUPT
  - atacmd.h, 627
- DISABLE\_WRITE\_CACHE
  - atacmd.h, 627
- disasm
  - cuc\_insn, 65
- disassemble\_index
  - or32.c, 433
- disassemble\_insn
  - or32.c, 433
- disassemble\_memory
  - abstract.c, 213
  - abstract.h, 231
- disassembled
  - or32.c, 435
- disassembled\_str
  - or32.c, 435
- dispose\_list
  - cuc.h, 472
  - insn.c, 485
- DISWIDTH
  - dumpverilog.c, 826
- dlh
  - dev\_16450, 74
- dll
  - dev\_16450, 74
- dma
  - eth\_device, 113
- dma-defs.h
  - DMA\_ADDR\_SPACE, 685
  - DMA\_CH\_A0, 685
  - DMA\_CH\_A0\_ADDR\_OFFSET, 685
  - DMA\_CH\_A0\_ADDR\_WIDTH, 685
  - DMA\_CH\_A1, 685
  - DMA\_CH\_A1\_ADDR\_OFFSET, 685
  - DMA\_CH\_A1\_ADDR\_WIDTH, 685
  - DMA\_CH\_AM0, 685
  - DMA\_CH\_AM0\_MASK\_OFFSET, 685
  - DMA\_CH\_AM0\_MASK\_WIDTH, 685
  - DMA\_CH\_AM1, 685
  - DMA\_CH\_AM1\_MASK\_OFFSET, 685
  - DMA\_CH\_AM1\_MASK\_WIDTH, 685
  - DMA\_CH\_BASE, 685
  - DMA\_CH\_CSR, 685
  - DMA\_CH\_CSR\_ARS\_OFFSET, 687
  - DMA\_CH\_CSR\_BUSY\_OFFSET, 687
  - DMA\_CH\_CSR\_CH\_EN\_OFFSET, 687
  - DMA\_CH\_CSR\_DONE\_OFFSET, 687
  - DMA\_CH\_CSR\_DST\_SEL\_OFFSET, 687
  - DMA\_CH\_CSR\_ERR\_OFFSET, 687
  - DMA\_CH\_CSR\_INC\_DST\_OFFSET, 687
  - DMA\_CH\_CSR\_INC\_SRC\_OFFSET, 687
  - DMA\_CH\_CSR\_INE\_CHK\_DONE\_-  
OFFSET, 687
  - DMA\_CH\_CSR\_INE\_DONE\_OFFSET, 687
  - DMA\_CH\_CSR\_INE\_ERR\_OFFSET, 687
  - DMA\_CH\_CSR\_INT\_CHUNK\_DONE\_-  
OFFSET, 687
  - DMA\_CH\_CSR\_INT\_DONE\_OFFSET, 687
  - DMA\_CH\_CSR\_INT\_ERR\_OFFSET, 687
  - DMA\_CH\_CSR\_MODE\_OFFSET, 687
  - DMA\_CH\_CSR\_PRIORITY\_OFFSET, 687
  - DMA\_CH\_CSR\_PRIORITY\_WIDTH, 687
  - DMA\_CH\_CSR\_RESERVED\_OFFSET, 687
  - DMA\_CH\_CSR\_RESERVED\_WIDTH, 687
  - DMA\_CH\_CSR\_REST\_EN\_OFFSET, 687
  - DMA\_CH\_CSR\_SRC\_SEL\_OFFSET, 687
  - DMA\_CH\_CSR\_STOP\_OFFSET, 687
  - DMA\_CH\_CSR\_SZ\_WB\_OFFSET, 687
  - DMA\_CH\_CSR\_USE\_ED\_OFFSET, 687
  - DMA\_CH\_CSR\_WRITE\_MASK, 687
  - DMA\_CH\_DESC, 687
  - DMA\_CH\_DESC\_ADDR\_OFFSET, 687
  - DMA\_CH\_DESC\_ADDR\_WIDTH, 687
  - DMA\_CH\_SIZE, 687
  - DMA\_CH\_SWPTR, 687
  - DMA\_CH\_SWPTR\_EN\_OFFSET, 689
  - DMA\_CH\_SWPTR\_PTR\_OFFSET, 689
  - DMA\_CH\_SWPTR\_PTR\_WIDTH, 689
  - DMA\_CH\_SZ, 689
  - DMA\_CH\_SZ\_CHK\_SZ\_OFFSET, 689
  - DMA\_CH\_SZ\_CHK\_SZ\_WIDTH, 689
  - DMA\_CH\_SZ\_TOT\_SZ\_OFFSET, 689
  - DMA\_CH\_SZ\_TOT\_SZ\_WIDTH, 689

- DMA\_CSR, 689
- DMA\_CSR\_PAUSE\_OFFSET, 689
- DMA\_DESC\_ADR0, 689
- DMA\_DESC\_ADR1, 689
- DMA\_DESC\_CSR, 689
- DMA\_DESC\_CSR\_DST\_SEL\_OFFSET, 689
- DMA\_DESC\_CSR\_EOL\_OFFSET, 689
- DMA\_DESC\_CSR\_INC\_DST\_OFFSET, 689
- DMA\_DESC\_CSR\_INC\_SRC\_OFFSET, 689
- DMA\_DESC\_CSR\_SRC\_SEL\_OFFSET, 689
- DMA\_DESC\_CSR\_TOT\_SZ\_OFFSET, 689
- DMA\_DESC\_CSR\_TOT\_SZ\_WIDTH, 689
- DMA\_DESC\_NEXT, 689
- DMA\_INT\_MSK\_A, 689
- DMA\_INT\_MSK\_B, 689
- DMA\_INT\_SRC\_A, 689
- DMA\_INT\_SRC\_B, 689
- DMA\_NUM\_CHANNELS, 689
- dma.c
  - CHANNEL\_ND\_I, 692
  - check\_dma\_ack\_o, 692
  - clear\_dma\_nd\_i, 692
  - clear\_dma\_req\_i, 692
  - dma\_baseaddr, 692
  - dma\_channel\_clock, 692
  - dma\_channel\_terminate\_transfer, 692
  - dma\_enabled, 693
  - dma\_init\_transfer, 693
  - dma\_irq, 693
  - dma\_load\_descriptor, 693
  - dma\_read32, 693
  - dma\_read\_ch\_csr, 694
  - dma\_reset, 694
  - dma\_sec\_end, 694
  - dma\_sec\_start, 694
  - dma\_status, 694
  - dma\_vapi\_id, 695
  - dma\_write32, 695
  - dma\_write\_ch\_csr, 695
  - dmass, 696
  - find\_dma\_controller\_ch, 695
  - masked\_increase, 696
  - reg\_dma\_sec, 696
  - set\_dma\_nd\_i, 696
  - set\_dma\_req\_i, 696
- dma.h
  - check\_dma\_ack\_o, 698
  - clear\_dma\_nd\_i, 698
  - clear\_dma\_req\_i, 698
  - find\_dma\_controller\_ch, 698
  - reg\_dma\_sec, 698
  - set\_dma\_nd\_i, 698
  - set\_dma\_req\_i, 698
- dma\_ack\_o
- dma\_channel, 81
- DMA\_ADDR\_SPACE
  - dma-defs.h, 685
- dma\_baseaddr
  - dma.c, 692
- DMA\_CH\_A0
  - dma-defs.h, 685
- DMA\_CH\_A0\_ADDR\_OFFSET
  - dma-defs.h, 685
- DMA\_CH\_A0\_ADDR\_WIDTH
  - dma-defs.h, 685
- DMA\_CH\_A1
  - dma-defs.h, 685
- DMA\_CH\_A1\_ADDR\_OFFSET
  - dma-defs.h, 685
- DMA\_CH\_A1\_ADDR\_WIDTH
  - dma-defs.h, 685
- DMA\_CH\_AM0
  - dma-defs.h, 685
- DMA\_CH\_AM0\_MASK\_OFFSET
  - dma-defs.h, 685
- DMA\_CH\_AM0\_MASK\_WIDTH
  - dma-defs.h, 685
- DMA\_CH\_AM1
  - dma-defs.h, 685
- DMA\_CH\_AM1\_MASK\_OFFSET
  - dma-defs.h, 685
- DMA\_CH\_AM1\_MASK\_WIDTH
  - dma-defs.h, 685
- DMA\_CH\_BASE
  - dma-defs.h, 685
- DMA\_CH\_CSR
  - dma-defs.h, 685
- DMA\_CH\_CSR\_ARS\_OFFSET
  - dma-defs.h, 687
- DMA\_CH\_CSR\_BUSY\_OFFSET
  - dma-defs.h, 687
- DMA\_CH\_CSR\_CH\_EN\_OFFSET
  - dma-defs.h, 687
- DMA\_CH\_CSR\_DONE\_OFFSET
  - dma-defs.h, 687
- DMA\_CH\_CSR\_DST\_SEL\_OFFSET
  - dma-defs.h, 687
- DMA\_CH\_CSR\_ERR\_OFFSET
  - dma-defs.h, 687
- DMA\_CH\_CSR\_INC\_DST\_OFFSET
  - dma-defs.h, 687
- DMA\_CH\_CSR\_INC\_SRC\_OFFSET
  - dma-defs.h, 687
- DMA\_CH\_CSR\_INE\_CHK\_DONE\_OFFSET
  - dma-defs.h, 687
- DMA\_CH\_CSR\_INE\_DONE\_OFFSET
  - dma-defs.h, 687
- DMA\_CH\_CSR\_INE\_ERR\_OFFSET

- dma-defs.h, 687
- DMA\_CH\_CSR\_INT\_CHUNK\_DONE\_OFFSET
  - dma-defs.h, 687
- DMA\_CH\_CSR\_INT\_DONE\_OFFSET
  - dma-defs.h, 687
- DMA\_CH\_CSR\_INT\_ERR\_OFFSET
  - dma-defs.h, 687
- DMA\_CH\_CSR\_MODE\_OFFSET
  - dma-defs.h, 687
- DMA\_CH\_CSR\_PRIORITY\_OFFSET
  - dma-defs.h, 687
- DMA\_CH\_CSR\_PRIORITY\_WIDTH
  - dma-defs.h, 687
- DMA\_CH\_CSR\_RESERVED\_OFFSET
  - dma-defs.h, 687
- DMA\_CH\_CSR\_RESERVED\_WIDTH
  - dma-defs.h, 687
- DMA\_CH\_CSR\_REST\_EN\_OFFSET
  - dma-defs.h, 687
- DMA\_CH\_CSR\_SRC\_SEL\_OFFSET
  - dma-defs.h, 687
- DMA\_CH\_CSR\_STOP\_OFFSET
  - dma-defs.h, 687
- DMA\_CH\_CSR\_SZ\_WB\_OFFSET
  - dma-defs.h, 687
- DMA\_CH\_CSR\_USE\_ED\_OFFSET
  - dma-defs.h, 687
- DMA\_CH\_CSR\_WRITE\_MASK
  - dma-defs.h, 687
- DMA\_CH\_DESC
  - dma-defs.h, 687
- DMA\_CH\_DESC\_ADDR\_OFFSET
  - dma-defs.h, 687
- DMA\_CH\_DESC\_ADDR\_WIDTH
  - dma-defs.h, 687
- DMA\_CH\_SIZE
  - dma-defs.h, 687
- DMA\_CH\_SWPTR
  - dma-defs.h, 687
- DMA\_CH\_SWPTR\_EN\_OFFSET
  - dma-defs.h, 689
- DMA\_CH\_SWPTR\_PTR\_OFFSET
  - dma-defs.h, 689
- DMA\_CH\_SWPTR\_PTR\_WIDTH
  - dma-defs.h, 689
- DMA\_CH\_SZ
  - dma-defs.h, 689
- DMA\_CH\_SZ\_CHK\_SZ\_OFFSET
  - dma-defs.h, 689
- DMA\_CH\_SZ\_CHK\_SZ\_WIDTH
  - dma-defs.h, 689
- DMA\_CH\_SZ\_TOT\_SZ\_OFFSET
  - dma-defs.h, 689
- DMA\_CH\_SZ\_TOT\_SZ\_WIDTH
  - dma-defs.h, 689
- dma-defs.h, 689
- dma\_channel, 80
  - a0, 81
  - a1, 81
  - am0, 81
  - am1, 81
  - channel\_mask, 81
  - channel\_number, 81
  - chunk\_size, 81
  - controller, 81
  - csr, 81
  - current\_descriptor, 81
  - desc, 81
  - destination, 81
  - destination\_mask, 81
  - dma\_ack\_o, 81
  - dma\_nd\_i, 81
  - dma\_req\_i, 81
  - load\_next\_descriptor\_when\_done, 81
  - referenced, 81
  - regs, 81
  - source, 81
  - source\_mask, 81
  - swptr, 81
  - sz, 81
  - total\_size, 81
  - words\_transferred, 81
- dma\_channel\_clock
  - dma.c, 692
- dma\_channel\_terminate\_transfer
  - dma.c, 692
- dma\_controller, 83
  - baseaddr, 84
  - ch, 84
  - csr, 84
  - enabled, 84
  - int\_msk\_a, 84
  - int\_msk\_b, 84
  - int\_src\_a, 84
  - int\_src\_b, 84
  - irq, 84
  - next, 84
  - regs, 84
  - vapi\_id, 84
- DMA\_CSR
  - dma-defs.h, 689
- DMA\_CSR\_PAUSE\_OFFSET
  - dma-defs.h, 689
- DMA\_DESC\_ADR0
  - dma-defs.h, 689
- DMA\_DESC\_ADR1
  - dma-defs.h, 689
- DMA\_DESC\_CSR
  - dma-defs.h, 689

- DMA\_DESC\_CSR\_DST\_SEL\_OFFSET
  - [dma-defs.h](#), 689
- DMA\_DESC\_CSR\_EOL\_OFFSET
  - [dma-defs.h](#), 689
- DMA\_DESC\_CSR\_INC\_DST\_OFFSET
  - [dma-defs.h](#), 689
- DMA\_DESC\_CSR\_INC\_SRC\_OFFSET
  - [dma-defs.h](#), 689
- DMA\_DESC\_CSR\_SRC\_SEL\_OFFSET
  - [dma-defs.h](#), 689
- DMA\_DESC\_CSR\_TOT\_SZ\_OFFSET
  - [dma-defs.h](#), 689
- DMA\_DESC\_CSR\_TOT\_SZ\_WIDTH
  - [dma-defs.h](#), 689
- DMA\_DESC\_NEXT
  - [dma-defs.h](#), 689
- [dma\\_enabled](#)
  - [dma.c](#), 693
- [dma\\_init\\_transfer](#)
  - [dma.c](#), 693
- DMA\_INT\_MSK\_A
  - [dma-defs.h](#), 689
- DMA\_INT\_MSK\_B
  - [dma-defs.h](#), 689
- DMA\_INT\_SRC\_A
  - [dma-defs.h](#), 689
- DMA\_INT\_SRC\_B
  - [dma-defs.h](#), 689
- [dma\\_irq](#)
  - [dma.c](#), 693
- [dma\\_load\\_descriptor](#)
  - [dma.c](#), 693
- [dma\\_mode](#)
  - [ata\\_device](#), 22
- DMA\_MODE0\_TD
  - [atahost.c](#), 649
- [dma\\_mode0\\_td](#)
  - [ata\\_host](#), 26
- DMA\_MODE0\_TEOC
  - [atahost.c](#), 649
- [dma\\_mode0\\_teoc](#)
  - [ata\\_host](#), 26
- DMA\_MODE0\_TM
  - [atahost.c](#), 649
- [dma\\_mode0\\_tm](#)
  - [ata\\_host](#), 26
- [dma\\_nd\\_i](#)
  - [dma\\_channel](#), 81
- DMA\_NUM\_CHANNELS
  - [dma-defs.h](#), 689
- [dma\\_read32](#)
  - [dma.c](#), 693
- [dma\\_read\\_ch\\_csr](#)
  - [dma.c](#), 694
- [dma\\_req\\_i](#)
  - [dma\\_channel](#), 81
- [dma\\_reset](#)
  - [dma.c](#), 694
- [dma\\_sec\\_end](#)
  - [dma.c](#), 694
- [dma\\_sec\\_start](#)
  - [dma.c](#), 694
- [dma\\_status](#)
  - [dma.c](#), 694
- [dma\\_vapi\\_id](#)
  - [dma.c](#), 695
- [dma\\_write32](#)
  - [dma.c](#), 695
- [dma\\_write\\_ch\\_csr](#)
  - [dma.c](#), 695
- [dmarq](#)
  - [ata\\_device](#), 22
- [dmas](#)
  - [dma.c](#), 696
- [dmmu](#), 85
  - [enabled](#), 86
  - [entrysize](#), 86
  - [hitdelay](#), 86
  - [lru\\_reload](#), 86
  - [missdelay](#), 86
  - [nsets](#), 86
  - [nways](#), 86
  - [page\\_mask](#), 86
  - [page\\_offset\\_mask](#), 86
  - [pagesize](#), 86
  - [pagesize\\_log2](#), 86
  - [set\\_mask](#), 86
  - [ustates](#), 86
  - [vpn\\_mask](#), 86
- [dmmu.c](#)
  - [dmmu\\_enabled](#), 573
  - [dmmu\\_end\\_sec](#), 573
  - [dmmu\\_entrysize](#), 573
  - [dmmu\\_find\\_tlbmr](#), 573
  - [dmmu\\_hitdelay](#), 574
  - [dmmu\\_missdelay](#), 574
  - [dmmu\\_nsets](#), 574
  - [dmmu\\_nways](#), 574
  - [dmmu\\_pagesize](#), 574
  - [dmmu\\_start\\_sec](#), 575
  - [dmmu\\_state](#), 577
  - [dmmu\\_translate](#), 575
  - [dmmu\\_ustates](#), 575
  - [dtlb\\_status](#), 576
  - [peek\\_into\\_dtlb](#), 576
  - [reg\\_dmmu\\_sec](#), 576
- [dmmu.h](#)
  - [DADDR\\_PAGE](#), 579

- dmmu\_simulate\_tlb, 579
- dmmu\_state, 580
- dmmu\_translate, 579
- peek\_into\_dtlb, 579
- reg\_dmmu\_sec, 579
- dmmu\_enabled
  - dmmu.c, 573
- dmmu\_end\_sec
  - dmmu.c, 573
- dmmu\_entrysize
  - dmmu.c, 573
- dmmu\_find\_tlbmr
  - dmmu.c, 573
- dmmu\_hitdelay
  - dmmu.c, 574
- dmmu\_missdelay
  - dmmu.c, 574
- dmmu\_nsets
  - dmmu.c, 574
- dmmu\_nways
  - dmmu.c, 574
- dmmu\_pagesize
  - dmmu.c, 574
- dmmu\_simulate\_tlb
  - dmmu.h, 579
- dmmu\_start\_sec
  - dmmu.c, 575
- dmmu\_state
  - dmmu.c, 577
  - dmmu.h, 580
- dmmu\_stats
  - stats.c, 282
  - stats.h, 285
- dmmu\_translate
  - dmmu.c, 575
  - dmmu.h, 579
- dmmu\_ustates
  - dmmu.c, 575
- dmmustats\_entry, 87
  - loads\_pagefaults, 87
  - loads\_tlbhit, 87
  - loads\_tlbmiss, 87
  - stores\_pagefaults, 87
  - stores\_tlbhit, 87
  - stores\_tlbmiss, 87
- do\_jump
  - op-support.c, 408
  - op-support.h, 409
- do\_sched\_wrap
  - op.c, 423
- do\_sched\_wrap\_delay
  - op.c, 424
- do\_scheduler
  - sched.c, 836
- sched.h, 838
- do\_stats
  - dyn-rec.c, 350
  - execute.c, 375
  - execute.h, 267
  - sim-config.h, 817
- done\_memory\_table
  - abstract.c, 213
  - abstract.h, 232
- DOWNLOAD\_MICROCODE
  - atacmd.h, 627
- dsize
  - COFF\_AOUTHDR, 40
- dstats
  - stats.c, 282
- dstats\_entry, 88
  - cnt\_dynamic, 88
  - depend, 88
  - insn1, 88
  - insn2, 88
- DSTATS\_LEN
  - stats.c, 281
- DT\_DEBUG
  - elf.h, 257
- DT\_FINI
  - elf.h, 257
- DT\_HASH
  - elf.h, 257
- DT\_HIPROC
  - elf.h, 257
- DT\_INIT
  - elf.h, 257
- DT\_JMPREL
  - elf.h, 257
- DT\_LOPROC
  - elf.h, 257
- DT\_NEEDED
  - elf.h, 257
- DT\_NULL
  - elf.h, 257
- DT\_PLTGOT
  - elf.h, 257
- DT\_PLTREL
  - elf.h, 257
- DT\_PLTRELSZ
  - elf.h, 257
- DT\_REL
  - elf.h, 257
- DT\_RELA
  - elf.h, 257
- DT\_RELAENT
  - elf.h, 257
- DT\_RELASZ
  - elf.h, 257

- DT\_RELENT
  - elf.h, 257
- DT\_RELSZ
  - elf.h, 257
- DT\_RPATH
  - elf.h, 257
- DT\_SONAME
  - elf.h, 257
- DT\_STRSZ
  - elf.h, 257
- DT\_STARTAB
  - elf.h, 257
- DT\_SYMBOLIC
  - elf.h, 257
- DT\_SYMENT
  - elf.h, 257
- DT\_SYMTAB
  - elf.h, 257
- DT\_TEXTREL
  - elf.h, 257
- dtlb\_status
  - dmmu.c, 576
- dtr0
  - ata\_host, 26
- dtr1
  - ata\_host, 26
- du\_reset
  - debug-unit.c, 521
  - debug-unit.h, 527
- dump\_exe\_log
  - execute.c, 370
  - execute.h, 263
- dump\_memory
  - abstract.c, 213
  - abstract.h, 232
- dump\_spr
  - spr-dump.c, 309
  - spr-dump.h, 320
  - sprs.h, 323
- dumphex
  - dumpverilog.c, 827
  - dumpverilog.h, 829
- dumpreg
  - execute.c, 370
  - execute.h, 264
- dumpverilog
  - dumpverilog.c, 827
  - dumpverilog.h, 829
- dumpverilog.c
  - DISWIDTH, 826
  - dumphex, 827
  - dumpverilog, 827
  - DW, 826
  - DWQ, 826
  - LABELEND\_CHAR, 826
  - OR1K\_MEM\_VERILOG\_FOOTER, 826
  - OR1K\_MEM\_VERILOG\_HEADER, 826
- dumpverilog.h
  - dumphex, 829
  - dumpverilog, 829
- dup\_func
  - bb.c, 444
  - cuc.h, 473
- DW
  - dumpverilog.c, 826
- DWQ
  - dumpverilog.c, 826
- dyn-rec.c
  - \_\_op\_param1, 350
  - \_\_op\_param2, 350
  - \_\_op\_param3, 350
  - add\_to\_op\_params, 335
  - add\_to\_opq, 335
  - DEF\_1T\_OP, 335
  - DEF\_2T\_OP, 335
  - DEF\_2T\_OP\_NEQ, 335
  - DEF\_3T\_OP, 335
  - DEF\_3T\_OP\_NEQ, 335
  - DEF\_GPR\_OP, 335
  - dirtyfy\_page, 335
  - do\_stats, 350
  - dyn\_checkwrite, 336
  - dyn\_main, 336
  - dyn\_ret\_stack\_prot, 336
  - dyn\_sigsegv\_debug, 337
  - enough\_host\_page, 337
  - eval\_insn\_ops, 337
  - find\_jump\_loc, 337
  - find\_t, 337
  - gen\_j\_imm, 338
  - gen\_j\_reg, 338
  - gen\_l\_add, 338
  - gen\_l\_addc, 338
  - gen\_l\_and, 338
  - gen\_l\_bf, 338
  - gen\_l\_bnf, 338
  - gen\_l\_cmov, 339
  - gen\_l\_cust1, 340
  - gen\_l\_cust2, 340
  - gen\_l\_cust3, 340
  - gen\_l\_cust4, 340
  - gen\_l\_cust5, 340
  - gen\_l\_cust6, 340
  - gen\_l\_cust7, 340
  - gen\_l\_cust8, 340
  - gen\_l\_div, 340
  - gen\_l\_divu, 340
  - gen\_l\_extbs, 340



- gen\_l\_extbz, 340
- gen\_l\_exths, 340
- gen\_l\_exthz, 340
- gen\_l\_extws, 340
- gen\_l\_extwz, 340
- gen\_l\_ffl, 340
- gen\_l\_invalid, 340
- gen\_l\_j, 340
- gen\_l\_jal, 340
- gen\_l\_jalr, 341
- gen\_l\_jr, 341
- gen\_l\_lbs, 341
- gen\_l\_lbz, 342
- gen\_l\_lhs, 342
- gen\_l\_lhz, 342
- gen\_l\_lws, 342
- gen\_l\_lwz, 342
- gen\_l\_mac, 342
- gen\_l\_macrc, 343
- gen\_l\_mfspr, 343
- gen\_l\_movhi, 343
- gen\_l\_msb, 343
- gen\_l\_mtspr, 343
- gen\_l\_mul, 343
- gen\_l\_mulu, 343
- gen\_l\_nop, 343
- gen\_l\_or, 343
- gen\_l\_rfe, 343
- gen\_l\_sb, 343
- gen\_l\_sfeq, 343
- gen\_l\_sfges, 344
- gen\_l\_sfgeu, 344
- gen\_l\_sfgts, 344
- gen\_l\_sfgtu, 344
- gen\_l\_sfles, 344
- gen\_l\_sfleu, 344
- gen\_l\_sflts, 344
- gen\_l\_sfltu, 344
- gen\_l\_sfne, 344
- gen\_l\_sh, 344
- gen\_l\_sll, 344
- gen\_l\_sra, 344
- gen\_l\_srl, 344
- gen\_l\_sub, 344
- gen\_l\_sw, 344
- gen\_l\_sys, 344
- gen\_l\_trap, 345
- gen\_l\_xor, 345
- gen\_lf\_add\_s, 345
- gen\_lf\_div\_s, 345
- gen\_lf\_ftoi\_s, 345
- gen\_lf\_itof\_s, 345
- gen\_lf\_madd\_s, 345
- gen\_lf\_mul\_s, 345
- gen\_lf\_rem\_s, 346
- gen\_lf\_sfeq\_s, 346
- gen\_lf\_sfge\_s, 346
- gen\_lf\_sfgt\_s, 346
- gen\_lf\_sfle\_s, 346
- gen\_lf\_sflt\_s, 346
- gen\_lf\_sfne\_s, 347
- gen\_lf\_sub\_s, 347
- gen\_op\_mark\_loc, 347
- generic\_gen\_op, 335
- imm\_gen\_op, 335
- immu\_retranslate, 347
- init\_dyn\_recomp, 348
- new\_dp, 348
- OPS\_ENLARGE\_BY, 335
- RECED\_PAGE\_ENLARGE\_BY, 335
- recheck\_immu, 348
- recompile\_delay\_insn, 348
- recompile\_insn, 349
- recompile\_page, 349
- run\_sched\_out\_of\_line, 349
- set\_pc\_delay\_gpr, 350
- ship\_gprs\_out\_t, 350
- ship\_t\_out, 350
- sigsegv\_addr, 351
- sigsegv\_state, 351
- T\_NONE, 335
- TFLAG\_DST, 335
- TFLAG\_SAVED, 335
- TFLAG\_SOURCED, 335
- TFLAG\_SRC, 335
- dyn-rec.h
  - add\_to\_op\_params, 353
  - add\_to\_opq, 353
  - dyn\_checkwrite, 353
  - dyn\_main, 353
  - enough\_host\_page, 354
  - enter\_dyn\_code, 354
  - gen\_code\_ent, 353
  - glue, 353
  - IMMU\_GOT\_DISABLED, 353
  - IMMU\_GOT\_ENABLED, 353
  - init\_dyn\_recomp, 354
  - new\_dp, 354
  - rec\_stack\_base, 356
  - recheck\_immu, 355
  - recompile\_page, 355
  - run\_sched\_out\_of\_line, 355
  - xglue, 353
- dyn32-defs.h
  - l\_none, 357
  - PARAMS, 357
- dyn\_checkwrite
  - dyn-rec.c, 336

- dyn-rec.h, 353
- dyn\_main
  - dyn-rec.c, 336
  - dyn-rec.h, 353
- dyn\_page, 89
  - delayr, 89
  - dirty, 89
  - host\_len, 89
  - host\_page, 89
  - insn\_indexs, 89
  - insns, 89
  - locs, 89
  - or\_page, 89
  - ts\_bound, 89
- dyn\_ret\_stack\_prot
  - dyn-rec.c, 336
- dyn\_sigsegv\_debug
  - dyn-rec.c, 337
- dynamic, 90
  - d\_ptr, 90
  - d\_tag, 90
  - d\_un, 90
  - d\_val, 90
- dyngen-elf.c
  - bffs, 359
  - elf\_close\_obj, 358
  - elf\_find\_func, 358
  - elf\_get\_func\_len, 358
  - elf\_get\_func\_name, 359
  - elf\_get\_func\_reloc, 359
  - elf\_get\_func\_start, 359
  - elf\_get\_sym\_name, 359
  - elf\_open\_obj, 359
- dyngen-i386.c
  - archfs, 360
  - i386\_gen\_func\_reloc, 360
  - i386\_gen\_reloc, 360
  - i386\_get\_real\_func\_len, 360
  - RET\_OPCODE, 360
- dyngen.c
  - c\_file\_head, 363
  - c\_rel\_file\_head, 363
  - c\_rel\_file\_tail, 363
  - c\_sw\_file\_head, 363
  - c\_sw\_file\_tail, 364
  - gen\_code\_proto, 364
  - gen\_func\_proto, 363
  - main, 363
  - MAX\_PARAMS, 363
  - OP\_FUNC\_PARAM\_PREFIX, 363
  - OP\_FUNC\_PREFIX, 363
- dyngen.h
  - archfs, 365
  - bffs, 365
- e
  - COFF\_syment, 50
- E\_DIMNUM
  - coff.h, 249
- e\_ehsize
  - elf32\_hdr, 92
  - elf64\_hdr, 101
- e\_entry
  - elf32\_hdr, 92
  - elf64\_hdr, 101
- E\_FILNMLEN
  - coff.h, 249
- e\_flags
  - elf32\_hdr, 92
  - elf64\_hdr, 101
- e\_hdr
  - elf\_obj, 109
- e\_ident
  - elf32\_hdr, 92
  - elf64\_hdr, 101
- e\_machine
  - elf32\_hdr, 92
  - elf64\_hdr, 101
- e\_name
  - COFF\_syment, 50
- e\_numaux
  - COFF\_syment, 50
- e\_offset
  - COFF\_syment, 50
- e\_phentsize
  - elf32\_hdr, 92
  - elf64\_hdr, 101
- e\_phnum
  - elf32\_hdr, 92
  - elf64\_hdr, 101
- e\_phoff
  - elf32\_hdr, 92
  - elf64\_hdr, 101
- e\_rel\_num
  - elf\_obj, 109
- e\_rel\_sec
  - elf\_obj, 109
- e\_rel\_sym
  - elf\_obj, 109
- e\_rela\_num
  - elf\_obj, 109
- e\_rela\_sec
  - elf\_obj, 109
- e\_rela\_sym
  - elf\_obj, 109
- e\_relas
  - elf\_obj, 109
- e\_rels
  - elf\_obj, 109

- e\_sclass
  - COFF\_syment, 50
- e\_scnnum
  - COFF\_syment, 50
- e\_sections
  - elf\_obj, 109
- e\_shdrs
  - elf\_obj, 109
- e\_shentsize
  - elf32\_hdr, 92
  - elf64\_hdr, 101
- e\_shnum
  - elf32\_hdr, 92
  - elf64\_hdr, 101
- e\_shoff
  - elf32\_hdr, 92
  - elf64\_hdr, 101
- e\_shstrndx
  - elf32\_hdr, 92
  - elf64\_hdr, 101
- e\_sym\_num
  - elf\_obj, 109
- e\_sym\_str\_tab
  - elf\_obj, 109
- E\_SYMNMLEN
  - coff.h, 249
- e\_syms
  - elf\_obj, 109
- e\_type
  - COFF\_syment, 50
  - elf32\_hdr, 92
  - elf64\_hdr, 101
- e\_value
  - COFF\_syment, 50
- e\_version
  - elf32\_hdr, 92
  - elf64\_hdr, 101
- e\_zeroes
  - COFF\_syment, 50
- edge\_trigger
  - config::pic, 57
- EF
  - or32.c, 432
- EFI
  - or32.c, 432
- EFN
  - or32.c, 432
- EI\_CLASS
  - elf.h, 257
- EI\_DATA
  - elf.h, 257
- EI\_MAG0
  - elf.h, 257
- EI\_MAG1
  - elf.h, 257
- EI\_MAG2
  - elf.h, 257
- EI\_MAG3
  - elf.h, 257
- EI\_NIDENT
  - elf.h, 257
- EI\_PAD
  - elf.h, 257
- EI\_VERSION
  - elf.h, 257
- elf.h
  - \_DYNAMIC, 260
  - AT\_BASE, 257
  - AT\_EGID, 257
  - AT\_ENTRY, 257
  - AT\_EUID, 257
  - AT\_EXECPD, 257
  - AT\_FLAGS, 257
  - AT\_GID, 257
  - AT\_IGNORE, 257
  - AT\_NOTELF, 257
  - AT\_NULL, 257
  - AT\_PAGESZ, 257
  - AT\_PHDR, 257
  - AT\_PHEXT, 257
  - AT\_PHNUM, 257
  - AT\_UID, 257
  - DT\_DEBUG, 257
  - DT\_FINI, 257
  - DT\_HASH, 257
  - DT\_HIPROC, 257
  - DT\_INIT, 257
  - DT\_JMPREL, 257
  - DT\_LOPROC, 257
  - DT\_NEEDED, 257
  - DT\_NULL, 257
  - DT\_PLTGOT, 257
  - DT\_PLTREL, 257
  - DT\_PLTRELSZ, 257
  - DT\_REL, 257
  - DT\_RELA, 257
  - DT\_RELAENT, 257
  - DT\_RELASZ, 257
  - DT\_RELENT, 257
  - DT\_RELSZ, 257
  - DT\_RPATH, 257
  - DT\_SONAME, 257
  - DT\_STRSZ, 257
  - DT\_STRTAB, 257
  - DT\_SYMBOLIC, 257
  - DT\_SYMENT, 257
  - DT\_SYMTAB, 257
  - DT\_TEXTREL, 257

- EL\_CLASS, 257
- EL\_DATA, 257
- EL\_MAG0, 257
- EL\_MAG1, 257
- EL\_MAG2, 257
- EL\_MAG3, 257
- EL\_NIDENT, 257
- EL\_PAD, 257
- EL\_VERSION, 257
- Elf32\_Addr, 260
- Elf32\_Dyn, 260
- Elf32\_Ehdr, 260
- Elf32\_Half, 260
- Elf32\_Nhdr, 260
- Elf32\_Off, 260
- Elf32\_Phdr, 260
- ELF32\_R\_SYM, 257
- ELF32\_R\_TYPE, 257
- Elf32\_Rel, 260
- Elf32\_Rela, 260
- Elf32\_Shdr, 260
- ELF32\_ST\_BIND, 257
- ELF32\_ST\_TYPE, 257
- Elf32\_Sword, 260
- Elf32\_Sym, 260
- Elf32\_Word, 260
- Elf64\_Ehdr, 260
- Elf64\_Nhdr, 260
- Elf64\_Phdr, 260
- Elf64\_Rel, 260
- Elf64\_Rela, 260
- Elf64\_Shdr, 260
- Elf64\_Sym, 260
- ELF\_LONG\_H, 257
- elf\_note, 258
- elf\_phdr, 258
- ELF\_SHORT\_H, 258
- ELFCLASS32, 258
- ELFCLASS64, 260
- ELFCLASSNONE, 260
- ELFCLASSNUM, 260
- ELFDATA2LSB, 260
- ELFDATA2MSB, 260
- ELFDATANONE, 260
- elfhdr, 260
- ELFMAG, 260
- ELFMAG0, 260
- ELFMAG1, 260
- ELFMAG2, 260
- ELFMAG3, 260
- EM\_386, 260
- EM\_486, 260
- EM\_68K, 260
- EM\_860, 260
- EM\_88K, 260
- EM\_ALPHA, 260
- EM\_M32, 260
- EM\_MIPS, 260
- EM\_MIPS\_RS4\_BE, 260
- EM\_NONE, 260
- EM\_PARISC, 260
- EM\_PPC, 260
- EM\_SPARC, 260
- EM\_SPARC32PLUS, 260
- EM\_SPARC64, 260
- ET\_CORE, 260
- ET\_DYN, 260
- ET\_EXEC, 260
- ET\_HIPROC, 260
- ET\_LOPROC, 260
- ET\_NONE, 260
- ET\_REL, 260
- EV\_CURRENT, 260
- EV\_NONE, 260
- EV\_NUM, 260
- NT\_PRFPREG, 260
- NT\_PRPSINFO, 260
- NT\_PRSTATUS, 260
- NT\_TASKSTRUCT, 260
- PF\_R, 260
- PF\_W, 260
- PF\_X, 260
- PT\_DYNAMIC, 260
- PT\_HIPROC, 260
- PT\_INTERP, 260
- PT\_LOAD, 260
- PT\_LOPROC, 260
- PT\_NOTE, 260
- PT\_NULL, 260
- PT\_PHDR, 260
- PT\_SHLIB, 260
- R\_386\_32, 260
- R\_386\_COPY, 260
- R\_386\_GLOB\_DAT, 260
- R\_386\_GOT32, 260
- R\_386\_GOTOFF, 260
- R\_386\_GOTPC, 260
- R\_386\_JMP\_SLOT, 260
- R\_386\_NONE, 260
- R\_386\_NUM, 260
- R\_386\_PC32, 260
- R\_386\_PLT32, 260
- R\_386\_RELATIVE, 260
- R\_68K\_16, 260
- R\_68K\_32, 260
- R\_68K\_8, 260
- R\_68K\_COPY, 260
- R\_68K\_GLOB\_DAT, 260

- R\_68K\_GOT16, 260
- R\_68K\_GOT16O, 260
- R\_68K\_GOT32, 260
- R\_68K\_GOT32O, 260
- R\_68K\_GOT8, 260
- R\_68K\_GOT8O, 260
- R\_68K\_JMP\_SLOT, 260
- R\_68K\_NONE, 260
- R\_68K\_PC16, 260
- R\_68K\_PC32, 260
- R\_68K\_PC8, 260
- R\_68K\_PLT16, 260
- R\_68K\_PLT16O, 260
- R\_68K\_PLT32, 260
- R\_68K\_PLT32O, 260
- R\_68K\_PLT8, 260
- R\_68K\_PLT8O, 260
- R\_68K\_RELATIVE, 260
- SELFMAG, 260
- SHF\_ALLOC, 260
- SHF\_EXECINSTR, 260
- SHF\_MASKPROC, 260
- SHF\_WRITE, 260
- SHN\_ABS, 260
- SHN\_COMMON, 260
- SHN\_HIPROC, 260
- SHN\_HIRESERVE, 260
- SHN\_LOPROC, 260
- SHN\_LORESERVE, 260
- SHN\_UNDEF, 260
- SHT\_DYNAMIC, 260
- SHT\_DYNSYM, 260
- SHT\_HASH, 260
- SHT\_HIPROC, 260
- SHT\_HIUSER, 260
- SHT\_LOPROC, 260
- SHT\_LOUSER, 260
- SHT\_NOBITS, 260
- SHT\_NOTE, 260
- SHT\_NULL, 260
- SHT\_NUM, 260
- SHT\_PROGBITS, 260
- SHT\_REL, 260
- SHT\_RELA, 260
- SHT\_SHLIB, 260
- SHT\_STRTAB, 260
- SHT\_SYMTAB, 260
- STB\_GLOBAL, 260
- STB\_LOCAL, 260
- STB\_WEAK, 260
- STT\_FILE, 260
- STT\_FUNC, 260
- STT\_NOTYPE, 260
- STT\_OBJECT, 260
- STT\_SECTION, 260
- Elf32\_Addr
  - elf.h, 260
- Elf32\_Dyn
  - elf.h, 260
- Elf32\_Ehdr
  - elf.h, 260
- Elf32\_Half
  - elf.h, 260
- elf32\_hdr, 91
  - e\_ehsize, 92
  - e\_entry, 92
  - e\_flags, 92
  - e\_ident, 92
  - e\_machine, 92
  - e\_phentsize, 92
  - e\_phnum, 92
  - e\_phoff, 92
  - e\_shentsize, 92
  - e\_shnum, 92
  - e\_shoff, 92
  - e\_shstrndx, 92
  - e\_type, 92
  - e\_version, 92
- Elf32\_Nhdr
  - elf.h, 260
- elf32\_note, 93
  - n\_descsz, 93
  - n\_namesz, 93
  - n\_type, 93
- Elf32\_Off
  - elf.h, 260
- Elf32\_Phdr
  - elf.h, 260
- elf32\_phdr, 94
  - p\_align, 94
  - p\_filesz, 94
  - p\_flags, 94
  - p\_memsz, 94
  - p\_offset, 94
  - p\_paddr, 94
  - p\_type, 94
  - p\_vaddr, 94
- ELF32\_R\_SYM
  - elf.h, 257
- ELF32\_R\_TYPE
  - elf.h, 257
- Elf32\_Rel
  - elf.h, 260
- elf32\_rel, 95
  - r\_info, 95
  - r\_offset, 95
- Elf32\_Rela
  - elf.h, 260

- elf32\_rela, 96
  - r\_addend, 96
  - r\_info, 96
  - r\_offset, 96
- Elf32\_Shdr
  - elf.h, 260
- elf32\_shdr, 97
  - sh\_addr, 97
  - sh\_addralign, 97
  - sh\_entsize, 97
  - sh\_flags, 97
  - sh\_info, 97
  - sh\_link, 97
  - sh\_name, 97
  - sh\_offset, 97
  - sh\_size, 97
  - sh\_type, 97
- ELF32\_ST\_BIND
  - elf.h, 257
- ELF32\_ST\_TYPE
  - elf.h, 257
- Elf32\_Sword
  - elf.h, 260
- Elf32\_Sym
  - elf.h, 260
- elf32\_sym, 98
  - st\_info, 98
  - st\_name, 98
  - st\_other, 98
  - st\_shndx, 98
  - st\_size, 98
  - st\_value, 98
- Elf32\_Word
  - elf.h, 260
- Elf64\_Dyn, 99
  - d\_ptr, 99
  - d\_tag, 99
  - d\_un, 99
  - d\_val, 99
- Elf64\_Ehdr
  - elf.h, 260
- elf64\_hdr, 100
  - e\_ehsize, 101
  - e\_entry, 101
  - e\_flags, 101
  - e\_ident, 101
  - e\_machine, 101
  - e\_phentsize, 101
  - e\_phnum, 101
  - e\_phoff, 101
  - e\_shentsize, 101
  - e\_shnum, 101
  - e\_shoff, 101
  - e\_shstrndx, 101
  - e\_type, 101
  - e\_version, 101
- Elf64\_Nhdr
  - elf.h, 260
- elf64\_note, 102
  - n\_descsz, 102
  - n\_namesz, 102
  - n\_type, 102
- Elf64\_Phdr
  - elf.h, 260
- elf64\_phdr, 103
  - p\_align, 103
  - p\_filesz, 103
  - p\_flags, 103
  - p\_memsz, 103
  - p\_offset, 103
  - p\_paddr, 103
  - p\_type, 103
  - p\_vaddr, 103
- Elf64\_Rel
  - elf.h, 260
- elf64\_rel, 104
  - r\_info, 104
  - r\_offset, 104
- Elf64\_Rela
  - elf.h, 260
- elf64\_rela, 105
  - r\_addend, 105
  - r\_info, 105
  - r\_offset, 105
- Elf64\_Shdr
  - elf.h, 260
- elf64\_shdr, 106
  - sh\_addr, 106
  - sh\_addralign, 106
  - sh\_entsize, 106
  - sh\_flags, 106
  - sh\_info, 106
  - sh\_link, 106
  - sh\_name, 106
  - sh\_offset, 106
  - sh\_size, 106
  - sh\_type, 106
- Elf64\_Sym
  - elf.h, 260
- elf64\_sym, 107
  - st\_info, 107
  - st\_name, 107
  - st\_other, 107
  - st\_shndx, 107
  - st\_size, 107
  - st\_value, 107
- elf\_close\_obj
  - dyngen-elf.c, 358

- elf\_find\_func
  - dyngen-elf.c, [358](#)
- elf\_get\_func\_len
  - dyngen-elf.c, [358](#)
- elf\_get\_func\_name
  - dyngen-elf.c, [359](#)
- elf\_get\_func\_reloc
  - dyngen-elf.c, [359](#)
- elf\_get\_func\_start
  - dyngen-elf.c, [359](#)
- elf\_get\_sym\_name
  - dyngen-elf.c, [359](#)
- ELF\_LONG\_H
  - elf.h, [257](#)
- elf\_note
  - elf.h, [258](#)
- elf\_obj, [108](#)
  - e\_hdr, [109](#)
  - e\_rel\_num, [109](#)
  - e\_rel\_sec, [109](#)
  - e\_rel\_sym, [109](#)
  - e\_rela\_num, [109](#)
  - e\_rela\_sec, [109](#)
  - e\_rela\_sym, [109](#)
  - e\_relas, [109](#)
  - e\_rels, [109](#)
  - e\_sections, [109](#)
  - e\_shdrs, [109](#)
  - e\_sym\_num, [109](#)
  - e\_sym\_str\_tab, [109](#)
  - e\_syms, [109](#)
- elf\_open\_obj
  - dyngen-elf.c, [359](#)
- elf\_phdr
  - elf.h, [258](#)
- ELF\_SHORT\_H
  - elf.h, [258](#)
- ELFCLASS32
  - elf.h, [258](#)
- ELFCLASS64
  - elf.h, [260](#)
- ELFCLASSNONE
  - elf.h, [260](#)
- ELFCLASSNUM
  - elf.h, [260](#)
- ELFDATA2LSB
  - elf.h, [260](#)
- ELFDATA2MSB
  - elf.h, [260](#)
- ELFDATANONE
  - elf.h, [260](#)
- elfhdr
  - elf.h, [260](#)
- ELFMAG
  - elf.h, [260](#)
- ELFMAG0
  - elf.h, [260](#)
- ELFMAG1
  - elf.h, [260](#)
- ELFMAG2
  - elf.h, [260](#)
- ELFMAG3
  - elf.h, [260](#)
- EM\_386
  - elf.h, [260](#)
- EM\_486
  - elf.h, [260](#)
- EM\_68K
  - elf.h, [260](#)
- EM\_860
  - elf.h, [260](#)
- EM\_88K
  - elf.h, [260](#)
- EM\_ALPHA
  - elf.h, [260](#)
- EM\_M32
  - elf.h, [260](#)
- EM\_MIPS
  - elf.h, [260](#)
- EM\_MIPS\_RS4\_BE
  - elf.h, [260](#)
- EM\_NONE
  - elf.h, [260](#)
- EM\_PARISC
  - elf.h, [260](#)
- EM\_PPC
  - elf.h, [260](#)
- EM\_SPARC
  - elf.h, [260](#)
- EM\_SPARC32PLUS
  - elf.h, [260](#)
- EM\_SPARC64
  - elf.h, [260](#)
- ENABLE\_ADVANCED\_POWER\_-  
MANAGEMENT
  - atacmd.h, [627](#)
- enable\_bursts
  - config, [55](#)
- ENABLE\_MEDIA\_STATUS\_NOTIFICATION
  - atacmd.h, [627](#)
- ENABLE\_POWERUP\_IN\_STANDBY\_-  
FEATURE\_SET
  - atacmd.h, [627](#)
- ENABLE\_READ\_LOOKAHEAD\_FEATURE
  - atacmd.h, [627](#)
- ENABLE\_RELEASE\_INTERRUPT
  - atacmd.h, [627](#)

- ENABLE\_REVERTING\_TO\_POWERON\_DEFAULTS
  - atacmd.h, 627
- ENABLE\_SERVICE\_INTERRUPT
  - atacmd.h, 627
- ENABLE\_WRITE\_CACHE
  - atacmd.h, 627
- enabled
  - ata\_host, 26
  - config, 55
  - config::pic, 57
  - dev\_16450, 74
  - dev\_generic, 77
  - dma\_controller, 84
  - dmmu, 86
  - eth\_device, 113
  - fb\_state, 118
  - gpio\_device, 124
  - ic, 127
  - immu, 129
  - kbd\_state, 144
  - mc, 147
  - runtime, 165
  - vga\_state, 180
- end\_addr
  - \_cuc\_func, 16
  - mprofiler.c, 591
- end\_cycles
  - runtime, 165
- end\_t\_func
  - ata\_device, 22
- enough\_host\_page
  - dyn-rec.c, 337
  - dyn-rec.h, 354
- enter\_dyn\_code
  - dyn-rec.h, 354
  - op.c, 424
- entry
  - COFF\_AOUTHDR, 40
- entrysize
  - dmmu, 86
  - immu, 129
- ERR
  - debug.h, 822
- ERR\_CRC
  - gdb.h, 529
- ERR\_MEM
  - gdb.h, 529
- ERR\_NONE
  - gdb.h, 529
- ERR\_
  - debug.h, 823
- ERR\_ON
  - debug.h, 823
- error
  - ata\_device, 22
  - eth\_device, 113
- ET\_CORE
  - elf.h, 260
- ET\_DYN
  - elf.h, 260
- ET\_EXEC
  - elf.h, 260
- ET\_HIPROC
  - elf.h, 260
- ET\_LOPROC
  - elf.h, 260
- ET\_NONE
  - elf.h, 260
- ET\_REL
  - elf.h, 260
- eth.c
  - ETH\_NUM\_VAPI\_IDS, 706
  - ETH\_VAPI\_CTRL, 705
  - ETH\_VAPI\_DATA, 705
  - ETH\_ADDR\_SPACE, 705
  - ETH\_ALEN, 705
  - eth\_baseaddr, 706
  - ETH\_BD\_BASE, 705
  - ETH\_BD\_COUNT, 705
  - ETH\_BD\_SPACE, 705
  - ETH\_CMODER\_PASSALL\_OFFSET, 705
  - ETH\_CMODER\_RXFLOW\_OFFSET, 705
  - ETH\_CMODER\_TXFLOW\_OFFSET, 705
  - ETH\_COLLCONF, 705
  - ETH\_COLLCONF\_COLLVALID\_OFFSET, 705
  - ETH\_COLLCONF\_COLLVALID\_WIDTH, 705
  - ETH\_COLLCONF\_MAXRET\_OFFSET, 705
  - ETH\_COLLCONF\_MAXRET\_WIDTH, 705
  - eth\_controller\_rx\_clock, 706
  - eth\_controller\_tx\_clock, 706
  - ETH\_CTRLMODER, 705
  - eth\_dma, 707
  - ETH\_DMA\_RX\_TX, 705
  - eth\_enabled, 707
  - ETH\_HASH0, 705
  - ETH\_HASH1, 705
  - ETH\_INT\_MASK, 705
  - ETH\_INT\_MASK\_BUSY\_M\_OFFSET, 705
  - ETH\_INT\_MASK\_RXB\_M\_OFFSET, 705
  - ETH\_INT\_MASK\_RXC\_M\_OFFSET, 705
  - ETH\_INT\_MASK\_RXE\_M\_OFFSET, 705
  - ETH\_INT\_MASK\_TXB\_M\_OFFSET, 705
  - ETH\_INT\_MASK\_TXC\_M\_OFFSET, 705
  - ETH\_INT\_MASK\_TXE\_M\_OFFSET, 705
  - ETH\_INT\_SOURCE, 705



- ETH\_INT\_SOURCE\_BUSY\_OFFSET, 705
- ETH\_INT\_SOURCE\_RXB\_OFFSET, 705
- ETH\_INT\_SOURCE\_RXC\_OFFSET, 705
- ETH\_INT\_SOURCE\_RXE\_OFFSET, 705
- ETH\_INT\_SOURCE\_TXB\_OFFSET, 705
- ETH\_INT\_SOURCE\_TXC\_OFFSET, 705
- ETH\_INT\_SOURCE\_TXE\_OFFSET, 705
- ETH\_IPGR1, 705
- ETH\_IPGR2, 705
- ETH\_IPGT, 705
- eth\_irq, 707
- ETH\_MAC\_ADDR0, 705
- ETH\_MAC\_ADDR1, 705
- ETH\_MAXPL, 705
- ETH\_MIIADDR\_FIAD\_OFFSET, 705
- ETH\_MIIADDR\_FIAD\_WIDTH, 705
- ETH\_MIIADDR\_RGAD\_OFFSET, 705
- ETH\_MIIADDR\_RGAD\_WIDTH, 705
- ETH\_MIIADDRESS, 705
- ETH\_MIICOMM\_RSTAT\_OFFSET, 705
- ETH\_MIICOMM\_SCANS\_OFFSET, 705
- ETH\_MIICOMM\_WCDATA\_OFFSET, 705
- ETH\_MIICOMMAND, 705
- ETH\_MIIMODER, 705
- ETH\_MIIMODER\_CLKDIV\_OFFSET, 705
- ETH\_MIIMODER\_CLKDIV\_WIDTH, 705
- ETH\_MIIMODER\_MRST\_OFFSET, 705
- ETH\_MIIMODER\_NOPRE\_OFFSET, 705
- ETH\_MIIRX\_DATA, 705
- ETH\_MIISTAT\_BUSY\_OFFSET, 705
- ETH\_MIISTAT\_FAIL\_OFFSET, 705
- ETH\_MIISTAT\_NVALID\_OFFSET, 705
- ETH\_MIISTATUS, 705
- ETH\_MIITX\_DATA, 705
- ETH\_MODER, 705
- ETH\_MODER\_BRO\_OFFSET, 705
- ETH\_MODER\_CRCEN\_OFFSET, 705
- ETH\_MODER\_DLYCRCEN\_OFFSET, 705
- ETH\_MODER\_DMAEN\_OFFSET, 705
- ETH\_MODER\_EXDFREN\_OFFSET, 705
- ETH\_MODER\_FULLD\_OFFSET, 705
- ETH\_MODER\_HUGEN\_OFFSET, 705
- ETH\_MODER\_IAM\_OFFSET, 705
- ETH\_MODER\_IFG\_OFFSET, 705
- ETH\_MODER\_LOOPBCK\_OFFSET, 705
- ETH\_MODER\_NOBCKOF\_OFFSET, 705
- ETH\_MODER\_NOPRE\_OFFSET, 705
- ETH\_MODER\_PAD\_OFFSET, 705
- ETH\_MODER\_PRO\_OFFSET, 705
- ETH\_MODER\_RECSMALL\_OFFSET, 705
- ETH\_MODER\_RST\_OFFSET, 705
- ETH\_MODER\_RXEN\_OFFSET, 705
- ETH\_MODER\_TXEN\_OFFSET, 705
- ETH\_PACKETLEN, 705
- ETH\_PACKETLEN\_MAXFL\_OFFSET, 705
- ETH\_PACKETLEN\_MAXFL\_WIDTH, 705
- ETH\_PACKETLEN\_MINFL\_OFFSET, 705
- ETH\_PACKETLEN\_MINFL\_WIDTH, 705
- eth\_read32, 707
- eth\_read\_rx\_file, 707
- eth\_reset, 707
- ETH\_RTX\_FILE, 705
- ETH\_RTX\_SOCKET, 705
- eth\_rtx\_type, 707
- ETH\_RTX\_VAPI, 705
- ETH\_RX\_BD\_COLLISION\_OFFSET, 705
- ETH\_RX\_BD\_CRC\_OFFSET, 705
- ETH\_RX\_BD\_DRIBBLE\_OFFSET, 705
- ETH\_RX\_BD\_INVALID\_OFFSET, 705
- ETH\_RX\_BD\_IRQ\_OFFSET, 705
- ETH\_RX\_BD\_LENGTH\_OFFSET, 705
- ETH\_RX\_BD\_LENGTH\_WIDTH, 705
- ETH\_RX\_BD\_MISS\_OFFSET, 705
- ETH\_RX\_BD\_READY\_OFFSET, 705
- ETH\_RX\_BD\_TOOBIG\_OFFSET, 705
- ETH\_RX\_BD\_TOOSHORT\_OFFSET, 705
- ETH\_RX\_BD\_UVERRUN\_OFFSET, 705
- ETH\_RX\_BD\_WRAP\_OFFSET, 705
- eth\_rx\_channel, 708
- eth\_rx\_next\_packet, 708
- eth\_rxfile, 708
- ETH\_RXSTATE\_IDLE, 705
- ETH\_RXSTATE\_RECV, 705
- ETH\_RXSTATE\_WAIT4BD, 705
- ETH\_RXSTATE\_WRITEFIFO, 705
- eth\_sec\_end, 708
- eth\_sec\_start, 711
- eth\_skip\_rx\_file, 711
- eth\_sockif, 711
- eth\_status, 711
- ETH\_TX\_BD\_COLLISION\_OFFSET, 705
- ETH\_TX\_BD\_CRC\_OFFSET, 705
- ETH\_TX\_BD\_DEFER\_OFFSET, 705
- ETH\_TX\_BD\_IRQ\_OFFSET, 705
- ETH\_TX\_BD\_LAST\_OFFSET, 705
- ETH\_TX\_BD\_LENGTH\_OFFSET, 705
- ETH\_TX\_BD\_LENGTH\_WIDTH, 705
- ETH\_TX\_BD\_NO\_CARRIER\_OFFSET, 705
- ETH\_TX\_BD\_NUM, 705
- ETH\_TX\_BD\_PAD\_OFFSET, 705
- ETH\_TX\_BD\_PAUSE\_OFFSET, 705
- ETH\_TX\_BD\_READY\_OFFSET, 705
- ETH\_TX\_BD\_RETRANSMIT\_OFFSET, 705
- ETH\_TX\_BD\_RETRY\_OFFSET, 705
- ETH\_TX\_BD\_RETRY\_WIDTH, 705
- ETH\_TX\_BD\_UNDERRUN\_OFFSET, 705
- ETH\_TX\_BD\_WRAP\_OFFSET, 705
- eth\_tx\_channel, 711

- eth\_txfile, 711
- ETH\_TXSTATE\_IDLE, 705
- ETH\_TXSTATE\_READFIFO, 705
- ETH\_TXSTATE\_TRANSMIT, 705
- ETH\_TXSTATE\_WAIT4BD, 705
- eth\_vapi\_id, 711
- eth\_vapi\_read, 712
- eth\_write32, 712
- eth\_write\_tx\_bd\_num, 712
- ETHER\_ADDR\_LEN, 705
- ETHER\_CRC\_LEN, 705
- ETHER\_HDR\_LEN, 705
- ETHER\_IS\_VALID\_LEN, 705
- ETHER\_MAX\_LEN, 705
- ETHER\_MIN\_LEN, 705
- ETHER\_TYPE\_LEN, 705
- ETHERMIN, 705
- ETHERMTU, 705
- ETHERTYPE\_ARP, 705
- ETHERTYPE\_IP, 705
- ETHERTYPE\_NTRAILER, 705
- ETHERTYPE\_PUP, 705
- ETHERTYPE\_REVARP, 705
- ETHERTYPE\_TRAIL, 705
- reg\_ethernet\_sec, 712
- eth.h
  - reg\_ethernet\_sec, 714
- ETH\_NUM\_VAPI\_IDS
  - eth.c, 706
- ETH\_VAPI\_CTRL
  - eth.c, 705
- ETH\_VAPI\_DATA
  - eth.c, 705
- ETH\_ADDR\_SPACE
  - eth.c, 705
- ETH\_ALEN
  - eth.c, 705
- eth\_baseaddr
  - eth.c, 706
- ETH\_BD\_BASE
  - eth.c, 705
- ETH\_BD\_COUNT
  - eth.c, 705
- ETH\_BD\_SPACE
  - eth.c, 705
- ETH\_CMODER\_PASSALL\_OFFSET
  - eth.c, 705
- ETH\_CMODER\_RXFLOW\_OFFSET
  - eth.c, 705
- ETH\_CMODER\_TXFLOW\_OFFSET
  - eth.c, 705
- ETH\_COLLCONF
  - eth.c, 705
- ETH\_COLLCONF\_COLLVALID\_OFFSET
  - eth.c, 705
- ETH\_COLLCONF\_COLLVALID\_WIDTH
  - eth.c, 705
- ETH\_COLLCONF\_MAXRET\_OFFSET
  - eth.c, 705
- ETH\_COLLCONF\_MAXRET\_WIDTH
  - eth.c, 705
- eth\_controller\_rx\_clock
  - eth.c, 706
- eth\_controller\_tx\_clock
  - eth.c, 706
- ETH\_CTRLMODER
  - eth.c, 705
- eth\_device, 110
  - add\_crc, 113
  - base\_vapi\_id, 113
  - baseaddr, 113
  - bd, 113
  - bd\_addr, 113
  - bd\_index, 113
  - bd\_ram, 113
  - bytes\_left, 113
  - bytes\_read, 113
  - bytes\_sent, 113
  - collconf, 113
  - controlmoder, 113
  - crc\_dly, 113
  - crc\_value, 113
  - dma, 113
  - enabled, 113
  - error, 113
  - fd, 113
  - hash0, 113
  - hash1, 113
  - ifr, 113
  - int\_mask, 113
  - int\_source, 113
  - ipgr1, 113
  - ipgr2, 113
  - ipgt, 113
  - lo\_buff, 113
  - loopback\_offset, 113
  - mac\_address, 113
  - mac\_int, 113
  - maximum\_length, 113
  - miiaddress, 113
  - miicommand, 113
  - miimoder, 113
  - miirx\_data, 113
  - miistatus, 113
  - miitx\_data, 113
  - minimum\_length, 113
  - moder, 113
  - offset, 113

- packet\_length, 113
- packetlen, 113
- regs, 113
- rfds, 113
- rtx\_sock, 113
- rtx\_type, 113
- rx, 113
- rx\_buff, 113
- rx\_channel, 113
- rxfd, 113
- rxfile, 113
- sockif, 113
- state, 113
- tx, 113
- tx\_bd\_num, 113
- tx\_buff, 113
- tx\_channel, 113
- txfd, 113
- txfile, 113
- waiting\_for\_dma, 113
- wfds, 113
- working, 113
- eth\_dma
  - eth.c, 707
- ETH\_DMA\_RX\_TX
  - eth.c, 705
- eth\_enabled
  - eth.c, 707
- ETH\_HASH0
  - eth.c, 705
- ETH\_HASH1
  - eth.c, 705
- ETH\_INT\_MASK
  - eth.c, 705
- ETH\_INT\_MASK\_BUSY\_M\_OFFSET
  - eth.c, 705
- ETH\_INT\_MASK\_RXB\_M\_OFFSET
  - eth.c, 705
- ETH\_INT\_MASK\_RXC\_M\_OFFSET
  - eth.c, 705
- ETH\_INT\_MASK\_RXE\_M\_OFFSET
  - eth.c, 705
- ETH\_INT\_MASK\_TXB\_M\_OFFSET
  - eth.c, 705
- ETH\_INT\_MASK\_TXC\_M\_OFFSET
  - eth.c, 705
- ETH\_INT\_MASK\_TXE\_M\_OFFSET
  - eth.c, 705
- ETH\_INT\_SOURCE
  - eth.c, 705
- ETH\_INT\_SOURCE\_BUSY\_OFFSET
  - eth.c, 705
- ETH\_INT\_SOURCE\_RXB\_OFFSET
  - eth.c, 705
- ETH\_INT\_SOURCE\_RXC\_OFFSET
  - eth.c, 705
- ETH\_INT\_SOURCE\_RXE\_OFFSET
  - eth.c, 705
- ETH\_INT\_SOURCE\_TXB\_OFFSET
  - eth.c, 705
- ETH\_INT\_SOURCE\_TXC\_OFFSET
  - eth.c, 705
- ETH\_INT\_SOURCE\_TXE\_OFFSET
  - eth.c, 705
- ETH\_IPGR1
  - eth.c, 705
- ETH\_IPGR2
  - eth.c, 705
- ETH\_IPGT
  - eth.c, 705
- eth\_irq
  - eth.c, 707
- ETH\_MAC\_ADDR0
  - eth.c, 705
- ETH\_MAC\_ADDR1
  - eth.c, 705
- ETH\_MAXPL
  - eth.c, 705
- ETH\_MIIADDR\_FIAD\_OFFSET
  - eth.c, 705
- ETH\_MIIADDR\_FIAD\_WIDTH
  - eth.c, 705
- ETH\_MIIADDR\_RGAD\_OFFSET
  - eth.c, 705
- ETH\_MIIADDR\_RGAD\_WIDTH
  - eth.c, 705
- ETH\_MIIADDRESS
  - eth.c, 705
- ETH\_MIICOMM\_RSTAT\_OFFSET
  - eth.c, 705
- ETH\_MIICOMM\_SCANS\_OFFSET
  - eth.c, 705
- ETH\_MIICOMM\_WCDATA\_OFFSET
  - eth.c, 705
- ETH\_MIICOMMAND
  - eth.c, 705
- ETH\_MIIMODER
  - eth.c, 705
- ETH\_MIIMODER\_CLKDIV\_OFFSET
  - eth.c, 705
- ETH\_MIIMODER\_CLKDIV\_WIDTH
  - eth.c, 705
- ETH\_MIIMODER\_MRST\_OFFSET
  - eth.c, 705
- ETH\_MIIMODER\_NOPRE\_OFFSET
  - eth.c, 705
- ETH\_MIIRX\_DATA
  - eth.c, 705

- ETH\_MIISTAT\_BUSY\_OFFSET  
eth.c, 705
- ETH\_MIISTAT\_FAIL\_OFFSET  
eth.c, 705
- ETH\_MIISTAT\_NVALID\_OFFSET  
eth.c, 705
- ETH\_MIISTATUS  
eth.c, 705
- ETH\_MIITX\_DATA  
eth.c, 705
- ETH\_MODER  
eth.c, 705
- ETH\_MODER\_BRO\_OFFSET  
eth.c, 705
- ETH\_MODER\_CRCEN\_OFFSET  
eth.c, 705
- ETH\_MODER\_DLYCRCEN\_OFFSET  
eth.c, 705
- ETH\_MODER\_DMAEN\_OFFSET  
eth.c, 705
- ETH\_MODER\_EXDFREN\_OFFSET  
eth.c, 705
- ETH\_MODER\_FULLD\_OFFSET  
eth.c, 705
- ETH\_MODER\_HUGEN\_OFFSET  
eth.c, 705
- ETH\_MODER\_IAM\_OFFSET  
eth.c, 705
- ETH\_MODER\_IFG\_OFFSET  
eth.c, 705
- ETH\_MODER\_LOOPBCK\_OFFSET  
eth.c, 705
- ETH\_MODER\_NOBCKOF\_OFFSET  
eth.c, 705
- ETH\_MODER\_NOPRE\_OFFSET  
eth.c, 705
- ETH\_MODER\_PAD\_OFFSET  
eth.c, 705
- ETH\_MODER\_PRO\_OFFSET  
eth.c, 705
- ETH\_MODER\_RECSMALL\_OFFSET  
eth.c, 705
- ETH\_MODER\_RST\_OFFSET  
eth.c, 705
- ETH\_MODER\_RXEN\_OFFSET  
eth.c, 705
- ETH\_MODER\_TXEN\_OFFSET  
eth.c, 705
- ETH\_PACKETLEN  
eth.c, 705
- ETH\_PACKETLEN\_MAXFL\_OFFSET  
eth.c, 705
- ETH\_PACKETLEN\_MAXFL\_WIDTH  
eth.c, 705
- ETH\_PACKETLEN\_MINFL\_OFFSET  
eth.c, 705
- ETH\_PACKETLEN\_MINFL\_WIDTH  
eth.c, 705
- eth\_read32  
eth.c, 707
- eth\_read\_rx\_file  
eth.c, 707
- eth\_reset  
eth.c, 707
- ETH\_RTX\_FILE  
eth.c, 705
- ETH\_RTX SOCK  
eth.c, 705
- eth\_rtx\_type  
eth.c, 707
- ETH\_RTX\_VAPI  
eth.c, 705
- ETH\_RX\_BD\_COLLISION\_OFFSET  
eth.c, 705
- ETH\_RX\_BD\_CRC\_OFFSET  
eth.c, 705
- ETH\_RX\_BD\_DRIBBLE\_OFFSET  
eth.c, 705
- ETH\_RX\_BD\_INVALID\_OFFSET  
eth.c, 705
- ETH\_RX\_BD\_IRQ\_OFFSET  
eth.c, 705
- ETH\_RX\_BD\_LENGTH\_OFFSET  
eth.c, 705
- ETH\_RX\_BD\_LENGTH\_WIDTH  
eth.c, 705
- ETH\_RX\_BD\_MISS\_OFFSET  
eth.c, 705
- ETH\_RX\_BD\_READY\_OFFSET  
eth.c, 705
- ETH\_RX\_BD\_TOOBIG\_OFFSET  
eth.c, 705
- ETH\_RX\_BD\_TOOSHORT\_OFFSET  
eth.c, 705
- ETH\_RX\_BD\_UVERRUN\_OFFSET  
eth.c, 705
- ETH\_RX\_BD\_WRAP\_OFFSET  
eth.c, 705
- eth\_rx\_channel  
eth.c, 708
- eth\_rx\_next\_packet  
eth.c, 708
- eth\_rxfile  
eth.c, 708
- ETH\_RXSTATE\_IDLE  
eth.c, 705
- ETH\_RXSTATE\_RECV  
eth.c, 705

- ETH\_RXSTATE\_WAIT4BD
  - eth.c, [705](#)
- ETH\_RXSTATE\_WRITEFIFO
  - eth.c, [705](#)
- eth\_sec\_end
  - eth.c, [708](#)
- eth\_sec\_start
  - eth.c, [711](#)
- eth\_skip\_rx\_file
  - eth.c, [711](#)
- eth\_sockif
  - eth.c, [711](#)
- eth\_status
  - eth.c, [711](#)
- ETH\_TX\_BD\_COLLISION\_OFFSET
  - eth.c, [705](#)
- ETH\_TX\_BD\_CRC\_OFFSET
  - eth.c, [705](#)
- ETH\_TX\_BD\_DEFER\_OFFSET
  - eth.c, [705](#)
- ETH\_TX\_BD\_IRQ\_OFFSET
  - eth.c, [705](#)
- ETH\_TX\_BD\_LAST\_OFFSET
  - eth.c, [705](#)
- ETH\_TX\_BD\_LENGTH\_OFFSET
  - eth.c, [705](#)
- ETH\_TX\_BD\_LENGTH\_WIDTH
  - eth.c, [705](#)
- ETH\_TX\_BD\_NO\_CARRIER\_OFFSET
  - eth.c, [705](#)
- ETH\_TX\_BD\_NUM
  - eth.c, [705](#)
- ETH\_TX\_BD\_PAD\_OFFSET
  - eth.c, [705](#)
- ETH\_TX\_BD\_PAUSE\_OFFSET
  - eth.c, [705](#)
- ETH\_TX\_BD\_READY\_OFFSET
  - eth.c, [705](#)
- ETH\_TX\_BD\_RETRANSMIT\_OFFSET
  - eth.c, [705](#)
- ETH\_TX\_BD\_RETRY\_OFFSET
  - eth.c, [705](#)
- ETH\_TX\_BD\_RETRY\_WIDTH
  - eth.c, [705](#)
- ETH\_TX\_BD\_UNDERRUN\_OFFSET
  - eth.c, [705](#)
- ETH\_TX\_BD\_WRAP\_OFFSET
  - eth.c, [705](#)
- eth\_tx\_channel
  - eth.c, [711](#)
- eth\_txfile
  - eth.c, [711](#)
- ETH\_TXSTATE\_IDLE
  - eth.c, [705](#)
- ETH\_TXSTATE\_READFIFO
  - eth.c, [705](#)
- ETH\_TXSTATE\_TRANSMIT
  - eth.c, [705](#)
- ETH\_TXSTATE\_WAIT4BD
  - eth.c, [705](#)
- eth\_vapi\_id
  - eth.c, [711](#)
- eth\_vapi\_read
  - eth.c, [712](#)
- eth\_write32
  - eth.c, [712](#)
- eth\_write\_tx\_bd\_num
  - eth.c, [712](#)
- ether\_addr, [115](#)
  - ether\_addr\_octet, [115](#)
- ETHER\_ADDR\_LEN
  - eth.c, [705](#)
- ether\_addr\_octet
  - ether\_addr, [115](#)
- ETHER\_CRC\_LEN
  - eth.c, [705](#)
- ether\_dhost
  - ether\_header, [116](#)
- ETHER\_HDR\_LEN
  - eth.c, [705](#)
- ether\_header, [116](#)
  - ether\_dhost, [116](#)
  - ether\_shost, [116](#)
  - ether\_type, [116](#)
- ETHER\_IS\_VALID\_LEN
  - eth.c, [705](#)
- ETHER\_MAX\_LEN
  - eth.c, [705](#)
- ETHER\_MIN\_LEN
  - eth.c, [705](#)
- ether\_shost
  - ether\_header, [116](#)
- ether\_type
  - ether\_header, [116](#)
- ETHER\_TYPE\_LEN
  - eth.c, [705](#)
- ETHERMIN
  - eth.c, [705](#)
- ETHERMTU
  - eth.c, [705](#)
- ETHERTYPE\_ARP
  - eth.c, [705](#)
- ETHERTYPE\_IP
  - eth.c, [705](#)
- ETHERTYPE\_NTRAILER
  - eth.c, [705](#)
- ETHERTYPE\_PUP
  - eth.c, [705](#)

- ETHERTYPE\_REVARP
  - eth.c, 705
- ETHERTYPE\_TRAIL
  - eth.c, 705
- EV\_CURRENT
  - elf.h, 260
- EV\_NONE
  - elf.h, 260
- EV\_NUM
  - elf.h, 260
- eval\_direct16
  - abstract.c, 214
  - abstract.h, 232
- eval\_direct32
  - abstract.c, 214
  - abstract.h, 233
- eval\_direct8
  - abstract.c, 215
  - abstract.h, 233
- eval\_insn
  - abstract.c, 215
  - abstract.h, 234
- eval\_insn\_ops
  - dyn-rec.c, 337
- eval\_label
  - labels.c, 269
  - labels.h, 271
- eval\_mem16
  - abstract.c, 215
  - abstract.h, 234
- eval\_mem32
  - abstract.c, 216
  - abstract.h, 235
- eval\_mem8
  - abstract.c, 216
  - abstract.h, 235
- eval\_mem\_16\_inv
  - abstract.c, 217
- eval\_mem\_16\_inv\_direct
  - abstract.c, 217
- eval\_mem\_32\_inv
  - abstract.c, 218
- eval\_mem\_32\_inv\_direct
  - abstract.c, 218
- eval\_mem\_8\_inv
  - abstract.c, 218
- eval\_mem\_8\_inv\_direct
  - abstract.c, 218
- eval\_operand\_val
  - execute.c, 371
  - execute.h, 264
- evalsim\_mem16
  - abstract.c, 219
  - abstract.h, 236
- evalsim\_mem32
  - abstract.c, 219
  - abstract.h, 236
- evalsim\_mem8
  - abstract.c, 219
  - abstract.h, 237
- evalsim\_reg
  - execute.c, 371
  - execute.h, 265
- except.c
  - except\_handle, 293
  - except\_pending, 293
  - op\_join\_mem\_cycles, 293
- except.h
  - EXCEPT\_ALIGN, 296
  - EXCEPT\_BUSERR, 296
  - EXCEPT\_DPF, 296
  - EXCEPT\_DTLBMISS, 296
  - EXCEPT\_FPE, 296
  - except\_handle, 296
  - EXCEPT\_ILLEGAL, 296
  - EXCEPT\_INT, 296
  - EXCEPT\_IPF, 296
  - EXCEPT\_ITLBMISS, 296
  - EXCEPT\_NONE, 296
  - except\_pending, 297
  - EXCEPT\_RANGE, 296
  - EXCEPT\_RESET, 296
  - EXCEPT\_SYSCALL, 296
  - EXCEPT\_TICK, 296
  - EXCEPT\_TRAP, 296
- EXCEPT\_ALIGN
  - except.h, 296
- EXCEPT\_BUSERR
  - except.h, 296
- EXCEPT\_DPF
  - except.h, 296
- EXCEPT\_DTLBMISS
  - except.h, 296
- EXCEPT\_FPE
  - except.h, 296
- except\_handle
  - except.c, 293
  - except.h, 296
- EXCEPT\_ILLEGAL
  - except.h, 296
- EXCEPT\_INT
  - except.h, 296
- EXCEPT\_IPF
  - except.h, 296
- EXCEPT\_ITLBMISS
  - except.h, 296
- EXCEPT\_NONE
  - except.h, 296

- except\_pending
  - except.c, 293
  - except.h, 297
- EXCEPT\_RANGE
  - except.h, 296
- EXCEPT\_RESET
  - except.h, 296
- EXCEPT\_SYSCALL
  - except.h, 296
- EXCEPT\_TICK
  - except.h, 296
- EXCEPT\_TRAP
  - except.h, 296
- exe\_log
  - config, 55
- exe\_log\_end
  - config, 55
- exe\_log\_fn
  - config, 55
- EXE\_LOG\_HARDWARE
  - sim-config.h, 813
- exe\_log\_marker
  - config, 55
- EXE\_LOG\_SIMPLE
  - sim-config.h, 813
- EXE\_LOG\_SOFTWARE
  - sim-config.h, 813
- exe\_log\_start
  - config, 55
- exe\_log\_type
  - config, 55
- exec\_main
  - execute.c, 372
  - execute.h, 265
- execute.c
  - analysis, 367
  - breakpoint, 375
  - check\_depend, 368
  - cpu\_clock, 368
  - cpu\_reset, 369
  - cpu\_state, 375
  - decode\_execute, 369
  - decode\_execute\_wrapper, 369
  - do\_stats, 375
  - dump\_exe\_log, 370
  - dumpreg, 370
  - eval\_operand\_val, 371
  - evalsim\_reg, 371
  - exec\_main, 372
  - fetch, 374
  - hist\_exec\_tail, 375
  - issued\_per\_cycle, 376
  - l\_invalid, 374
  - multitissue, 376
  - next\_delay\_insn, 376
  - pcnext, 376
  - sbuf\_buf, 376
  - sbuf\_count, 376
  - sbuf\_head, 376
  - sbuf\_load, 374
  - sbuf\_prev\_cycles, 376
  - sbuf\_store, 375
  - sbuf\_tail, 376
  - sbuf\_total\_cyc, 376
  - sbuf\_wait\_cyc, 376
  - setsim\_reg, 375
  - update\_pc, 375
- execute.h
  - analysis, 262
  - cpu\_clock, 262
  - cpu\_reset, 263
  - cpu\_state, 267
  - CURINSN, 262
  - depend\_operands, 263
  - do\_stats, 267
  - dump\_exe\_log, 263
  - dumpreg, 264
  - eval\_operand\_val, 264
  - evalsim\_reg, 265
  - exec\_main, 265
  - hist\_exec\_tail, 267
  - pcnext, 267
  - sbuf\_total\_cyc, 267
  - sbuf\_wait\_cyc, 267
  - SET\_OV\_FLAG\_FN, 262
  - setsim\_reg, 267
- EXECUTE\_DEVICE\_DIAGNOSTICS
  - atacmd.h, 627
- expand\_bb
  - bb.c, 444
  - cuc.h, 473
- expand\_branch
  - load.c, 496
- expand\_calls
  - load.c, 496
- expand\_memory
  - load.c, 497
- expand\_signed
  - load.c, 497
- ext
  - config, 55
- EXT\_CAST
  - op.c, 423
- ext\_int\_clr
  - runtime, 165
- ext\_int\_set
  - runtime, 165
- EXT\_NAME

- op.c, 423
- ext\_read
  - generic.c, 726
- EXT\_TYPE
  - op.c, 423
- ext\_write
  - generic.c, 726
- extend\_imm
  - or32.c, 433
- external\_clock
  - gpio\_device, 124
- extract\_function
  - cuc.c, 454
- f\_flags
  - COFF\_filehdr, 45
- f\_magic
  - COFF\_filehdr, 45
- f\_nscns
  - COFF\_filehdr, 45
- f\_nsyms
  - COFF\_filehdr, 45
- f\_opthdr
  - COFF\_filehdr, 45
- f\_symptr
  - COFF\_filehdr, 45
- f\_timdat
  - COFF\_filehdr, 45
- FALSE
  - gdbcomm.h, 535
- fb.c
  - CAM\_SIZEX, 717
  - CAM\_SIZEY, 717
  - change\_buf\_addr, 718
  - CNV16, 717
  - CNV32, 717
  - fb\_baseaddr, 718
  - FB\_BUFADDR, 717
  - FB\_CAMBUFADDR, 717
  - FB\_CAMPOSADDR, 717
  - FB\_CTRL, 717
  - fb\_dump\_image24, 718
  - fb\_dump\_image8, 718
  - fb\_enabled, 718
  - fb\_filename, 718
  - fb\_job, 718
  - FB\_PAL, 717
  - fb\_read32, 719
  - fb\_refresh\_rate, 719
  - fb\_reset, 719
  - fb\_sec\_end, 719
  - fb\_sec\_start, 720
  - FB\_SIZEX, 717
  - FB\_SIZEY, 717
- FB\_WRAP, 717
- fb\_write32, 720
- REFRESH\_DIVIDER, 717
- reg\_fb\_sec, 720
- fb.h
  - reg\_fb\_sec, 722
- fb\_baseaddr
  - fb.c, 718
- FB\_BUFADDR
  - fb.c, 717
- FB\_CAMBUFADDR
  - fb.c, 717
- FB\_CAMPOSADDR
  - fb.c, 717
- FB\_CTRL
  - fb.c, 717
- fb\_dump\_image24
  - fb.c, 718
- fb\_dump\_image8
  - fb.c, 718
- fb\_enabled
  - fb.c, 718
- fb\_filename
  - fb.c, 718
- fb\_job
  - fb.c, 718
- FB\_PAL
  - fb.c, 717
- fb\_read32
  - fb.c, 719
- fb\_refresh\_rate
  - fb.c, 719
- fb\_reset
  - fb.c, 719
- fb\_sec\_end
  - fb.c, 719
- fb\_sec\_start
  - fb.c, 720
- FB\_SIZEX
  - fb.c, 717
- FB\_SIZEY
  - fb.c, 717
- fb\_state, 117
  - addr, 118
  - baseaddr, 118
  - cam\_addr, 118
  - camera\_pos, 118
  - camerax, 118
  - cameray, 118
  - ctrl, 118
  - enabled, 118
  - filename, 118
  - in\_refresh, 118
  - pal, 118



- pic, 118
- refresh, 118
- refresh\_count, 118
- refresh\_rate, 118
- FB\_WRAP
  - fb.c, 717
- fb\_write32
  - fb.c, 720
- fcr
  - dev\_16450, 74
- fd
  - eth\_device, 113
  - vapi\_handler, 178
- fd.c
  - fd\_channel\_ops, 667
  - fd\_init, 667
  - fd\_isok, 667
  - fd\_read, 667
  - fd\_status, 667
  - fd\_status\_fd, 667
  - fd\_write, 667
- fd.h
  - fd\_channel\_ops, 668
  - fd\_read, 668
  - fd\_write, 668
- fd\_channel, 119
  - fdin, 119
  - fdout, 119
- fd\_channel\_ops
  - fd.c, 667
  - fd.h, 668
- fd\_init
  - fd.c, 667
- fd\_isok
  - fd.c, 667
- fd\_read
  - fd.c, 667
  - fd.h, 668
- fd\_status
  - fd.c, 667
- fd\_status\_fd
  - fd.c, 667
- fd\_write
  - fd.c, 667
  - fd.h, 668
- fdeps
  - \_cuc\_func, 16
- fdin
  - fd\_channel, 119
- fdout
  - fd\_channel, 119
- fds
  - file\_channel, 120
  - tcp\_channel, 176
  - tty\_channel, 177
  - vapi.c, 873
  - xterm\_channel, 181
- features
  - ata\_device, 22
- fetch
  - execute.c, 374
- fetch\_pagefaults
  - immustats\_entry, 130
- fetch\_tlbhit
  - immustats\_entry, 130
- fetch\_tlbmiss
  - immustats\_entry, 130
- fexe\_log
  - runtime, 165
- FIELD\_MASK
  - fields.h, 724
- FIELD\_SHIFT
  - fields.h, 724
- fields.h
  - ASSIGN\_FLAG, 723
  - CLEAR\_FLAG, 723
  - FIELD\_MASK, 724
  - FIELD\_SHIFT, 724
  - FLAG\_MASK, 724
  - FLAG\_SHIFT, 724
  - GET\_FIELD, 724
  - SET\_FIELD, 724
  - SET\_FLAG, 724
  - TEST\_FLAG, 724
- fifo\_len
  - dev\_16450, 74
- file
  - ata\_device, 22
- file.c
  - file\_channel\_ops, 670
  - file\_close, 670
  - file\_free, 670
  - file\_init, 670
  - file\_open, 670
- file.h
  - file\_channel\_ops, 671
- file\_channel, 120
  - fds, 120
  - namein, 120
  - nameout, 120
- file\_channel\_ops
  - file.c, 670
  - file.h, 671
- file\_close
  - file.c, 670
- file\_free
  - file.c, 670
- file\_init

- file.c, 670
- file\_open
  - file.c, 670
- filename
  - fb\_state, 118
  - runtime, 165
  - vga\_state, 180
- find\_channel\_factory
  - channel.c, 664
- find\_dma\_controller\_ch
  - dma.c, 695
  - dma.h, 698
- find\_handler
  - vapi.c, 869
- find\_jump\_loc
  - dyn-rec.c, 337
- find\_label
  - labels.c, 269
  - labels.h, 271
- find\_lsc\_index
  - verilog.c, 511
- find\_t
  - dyn-rec.c, 337
- firmware
  - ata\_device, 22
- first
  - cuc\_bb, 63
- FIXME
  - debug.h, 823
- FIXME\_
  - debug.h, 823
- FIXME\_ON
  - debug.h, 823
- FLAG\_MASK
  - fields.h, 724
- FLAG\_REG
  - cuc.h, 469
- FLAG\_SHIFT
  - fields.h, 724
- flog
  - cuc.c, 463
  - cuc.h, 481
- FLUSH\_CACHE
  - atacmd.h, 627
- fmprof
  - runtime, 165
- FMTLEN
  - simprintf.c, 840
- fmtstr
  - simprintf.c, 840
- fo
  - sprs.c, 322
- FORCE\_RET
  - op-i386.h, 403
- format\_func\_options
  - cuc.c, 454
- forward
  - branchstat, 32
- fout
  - runtime, 165
- fprof
  - mprofiler.c, 591
  - profiler.c, 782
  - runtime, 165
- free
  - channel\_ops, 39
- free\_func
  - bb.c, 444
  - cuc.h, 473
- free\_job\_queue
  - scheduler\_struct, 168
- freemem
  - parse.c, 277
- from
  - \_csm\_list, 14
  - cuc\_conv, 64
- from\_spr
  - spr\_def, 173
- fstats
  - stats.c, 282
- fstats\_entry, 121
  - cnt\_dynamic, 121
  - depend, 121
  - insn1, 121
  - insn2, 121
- FSTATS\_LEN
  - stats.c, 281
- func
  - config\_param, 58
  - cuc.c, 463
  - sched\_entry, 167
- func\_index
  - verilog.c, 511
- func\_offset
  - reloc, 161
- func\_struct, 122
  - addr, 122
  - calls, 122
  - cum\_cycles, 122
  - name, 122
- func\_unit\_str
  - stats.c, 282
- func\_v
  - cuc.c, 463
- gdb.h
  - ERR\_CRC, 529
  - ERR\_MEM, 529

- ERR\_NONE, 529
- JTAG\_PROXY\_ACCESS\_EXCEPTION, 530
- JTAG\_PROXY\_COMMAND\_NOT\_IMPLEMENTED, 530
- JTAG\_PROXY\_INVALID\_ADDRESS, 530
- JTAG\_PROXY\_INVALID\_CHAIN, 530
- JTAG\_PROXY\_INVALID\_COMMAND, 530
- JTAG\_PROXY\_INVALID\_LENGTH, 530
- JTAG\_PROXY\_NO\_CONNECTION, 530
- JTAG\_PROXY\_OUT\_OF\_MEMORY, 530
- JTAG\_PROXY\_PROTOCOL\_ERROR, 530
- JTAG\_PROXY\_SERVER\_TERMINATED, 530
- OR1K\_JTAG\_COMMAND\_CHAIN, 530
- OR1K\_JTAG\_COMMAND\_READ, 530
- OR1K\_JTAG\_COMMAND\_READ\_BLOCK, 530
- OR1K\_JTAG\_COMMAND\_WRITE, 530
- OR1K\_JTAG\_COMMAND\_WRITE\_BLOCK, 530
- or1k\_jtag\_errors, 529
- or1k\_jtag\_proxy\_protocol\_commands, 530
- GDB\_BUF\_MAX
  - rsp-server.c, 539
- gdb\_enabled
  - config, 55
- gdb\_fd
  - gdbcomm.c, 534
- gdb\_read
  - gdbcomm.c, 532
- gdb\_request
  - gdbcomm.c, 532
- gdb\_write
  - gdbcomm.c, 532
- gdbcomm.c
  - block\_jtag, 532
  - gdb\_fd, 534
  - gdb\_read, 532
  - gdb\_request, 532
  - gdb\_write, 532
  - gdbcomm\_init, 533
  - get\_server\_socket, 533
  - handle\_server\_socket, 533
  - jtag\_request, 533
  - protocol\_clean, 534
  - server\_fd, 534
  - server\_ip, 534
  - server\_port, 534
  - tcp\_level, 534
- gdbcomm.h
  - block\_jtag, 535
  - boolean, 535
  - FALSE, 535
  - gdbcomm\_init, 535
  - handle\_server\_socket, 535
  - TRUE, 535
- gdbcomm\_init
  - gdbcomm.c, 533
  - gdbcomm.h, 535
- GEN
  - verilog.c, 511
- gen\_code\_ent
  - dyn-rec.h, 353
- gen\_code\_proto
  - dyngen.c, 364
- gen\_eval\_operands
  - generate.c, 377
- gen\_func\_proto
  - dyngen.c, 363
- gen\_func\_reloc
  - archf, 18
- gen\_j\_imm
  - dyn-rec.c, 338
- gen\_j\_reg
  - dyn-rec.c, 338
- gen\_l\_add
  - dyn-rec.c, 338
- gen\_l\_addc
  - dyn-rec.c, 338
- gen\_l\_and
  - dyn-rec.c, 338
- gen\_l\_bf
  - dyn-rec.c, 338
- gen\_l\_bnf
  - dyn-rec.c, 338
- gen\_l\_cmov
  - dyn-rec.c, 339
- gen\_l\_cust1
  - dyn-rec.c, 340
- gen\_l\_cust2
  - dyn-rec.c, 340
- gen\_l\_cust3
  - dyn-rec.c, 340
- gen\_l\_cust4
  - dyn-rec.c, 340
- gen\_l\_cust5
  - dyn-rec.c, 340
- gen\_l\_cust6
  - dyn-rec.c, 340
- gen\_l\_cust7
  - dyn-rec.c, 340
- gen\_l\_cust8
  - dyn-rec.c, 340
- gen\_l\_div
  - dyn-rec.c, 340
- gen\_l\_divu
  - dyn-rec.c, 340
- gen\_l\_extbs

- dyn-rec.c, 340
- gen\_l\_extbz
  - dyn-rec.c, 340
- gen\_l\_exths
  - dyn-rec.c, 340
- gen\_l\_exthz
  - dyn-rec.c, 340
- gen\_l\_extws
  - dyn-rec.c, 340
- gen\_l\_extwz
  - dyn-rec.c, 340
- gen\_l\_ffl
  - dyn-rec.c, 340
- gen\_l\_invalid
  - dyn-rec.c, 340
- gen\_l\_j
  - dyn-rec.c, 340
- gen\_l\_jal
  - dyn-rec.c, 340
- gen\_l\_jalr
  - dyn-rec.c, 341
- gen\_l\_jr
  - dyn-rec.c, 341
- gen\_l\_lbs
  - dyn-rec.c, 341
- gen\_l\_lbz
  - dyn-rec.c, 342
- gen\_l\_lhs
  - dyn-rec.c, 342
- gen\_l\_lhz
  - dyn-rec.c, 342
- gen\_l\_lws
  - dyn-rec.c, 342
- gen\_l\_lwz
  - dyn-rec.c, 342
- gen\_l\_mac
  - dyn-rec.c, 342
- gen\_l\_macrc
  - dyn-rec.c, 343
- gen\_l\_mfspr
  - dyn-rec.c, 343
- gen\_l\_movhi
  - dyn-rec.c, 343
- gen\_l\_msb
  - dyn-rec.c, 343
- gen\_l\_mtspr
  - dyn-rec.c, 343
- gen\_l\_mul
  - dyn-rec.c, 343
- gen\_l\_mulu
  - dyn-rec.c, 343
- gen\_l\_nop
  - dyn-rec.c, 343
- gen\_l\_or
  - dyn-rec.c, 343
- gen\_l\_rfe
  - dyn-rec.c, 343
- gen\_l\_sb
  - dyn-rec.c, 343
- gen\_l\_sfeq
  - dyn-rec.c, 343
- gen\_l\_sfges
  - dyn-rec.c, 344
- gen\_l\_sfges
  - dyn-rec.c, 344
- gen\_l\_sfgts
  - dyn-rec.c, 344
- gen\_l\_sfgtu
  - dyn-rec.c, 344
- gen\_l\_sfles
  - dyn-rec.c, 344
- gen\_l\_sfleu
  - dyn-rec.c, 344
- gen\_l\_sflts
  - dyn-rec.c, 344
- gen\_l\_sfltu
  - dyn-rec.c, 344
- gen\_l\_sfne
  - dyn-rec.c, 344
- gen\_l\_sh
  - dyn-rec.c, 344
- gen\_l\_sll
  - dyn-rec.c, 344
- gen\_l\_sra
  - dyn-rec.c, 344
- gen\_l\_srl
  - dyn-rec.c, 344
- gen\_l\_sub
  - dyn-rec.c, 344
- gen\_l\_sw
  - dyn-rec.c, 344
- gen\_l\_sys
  - dyn-rec.c, 344
- gen\_l\_trap
  - dyn-rec.c, 345
- gen\_l\_xor
  - dyn-rec.c, 345
- gen\_lf\_add\_s
  - dyn-rec.c, 345
- gen\_lf\_div\_s
  - dyn-rec.c, 345
- gen\_lf\_ftoi\_s
  - dyn-rec.c, 345
- gen\_lf\_itof\_s
  - dyn-rec.c, 345
- gen\_lf\_madd\_s
  - dyn-rec.c, 345
- gen\_lf\_mul\_s

- dyn-rec.c, 345
- gen\_lf\_rem\_s
  - dyn-rec.c, 346
- gen\_lf\_sfreq\_s
  - dyn-rec.c, 346
- gen\_lf\_sfge\_s
  - dyn-rec.c, 346
- gen\_lf\_sfgt\_s
  - dyn-rec.c, 346
- gen\_lf\_sfle\_s
  - dyn-rec.c, 346
- gen\_lf\_sflt\_s
  - dyn-rec.c, 346
- gen\_lf\_sfne\_s
  - dyn-rec.c, 347
- gen\_lf\_sub\_s
  - dyn-rec.c, 347
- gen\_op\_mark\_loc
  - dyn-rec.c, 347
- gen\_option
  - cuc.c, 454
- gen\_reloc
  - archf, 18
- generate.c
  - gen\_eval\_operands, 377
  - generate\_body, 378
  - generate\_footer, 378
  - generate\_header, 378
  - in\_file, 379
  - main, 378
  - out\_file, 379
  - out\_lines, 379
  - output\_call, 378
  - output\_function, 379
  - shift\_fprintf, 379
  - write\_to\_reg, 379
- generate\_bb\_seq
  - bb.c, 444
  - cuc.h, 473
- generate\_body
  - generate.c, 378
- generate\_footer
  - generate.c, 378
- generate\_function
  - cuc.c, 456
- generate\_header
  - generate.c, 378
- generate\_main
  - verilog.c, 511
  - verilog.h, 513
- generate\_time\_pretty
  - abstract.c, 220
  - abstract.h, 237
- generic.c
  - ext\_read, 726
  - ext\_write, 726
  - generic\_baseaddr, 726
  - generic\_byte\_enabled, 726
  - generic\_enabled, 726
  - generic\_hw\_enabled, 726
  - generic\_name, 726
  - generic\_read\_byte, 726
  - generic\_read\_hw, 726
  - generic\_read\_word, 726
  - generic\_reset, 727
  - generic\_sec\_end, 727
  - generic\_sec\_start, 727
  - generic\_size, 728
  - generic\_status, 728
  - generic\_word\_enabled, 728
  - generic\_write\_byte, 728
  - generic\_write\_hw, 728
  - generic\_write\_word, 728
  - html, 728
  - htoms, 729
  - mtohl, 729
  - mtohs, 729
  - reg\_generic\_sec, 729
- generic.h
  - reg\_generic\_sec, 731
- GENERIC\_BYTE
  - dev\_generic, 76
- GENERIC\_HW
  - dev\_generic, 76
- GENERIC\_READ
  - dev\_generic, 76
- GENERIC\_WORD
  - dev\_generic, 76
- GENERIC\_WRITE
  - dev\_generic, 76
- generic\_baseaddr
  - generic.c, 726
- generic\_byte\_enabled
  - generic.c, 726
- generic\_close
  - channels/generic.c, 730
  - channels/generic.h, 732
- generic\_enabled
  - generic.c, 726
- generic\_free
  - channels/generic.c, 730
  - channels/generic.h, 732
- generic\_gen\_op
  - dyn-rec.c, 335
- generic\_hw\_enabled
  - generic.c, 726
- generic\_name
  - generic.c, 726

- generic\_open
  - channels/generic.c, 730
  - channels/generic.h, 732
- generic\_read\_byte
  - generic.c, 726
- generic\_read\_hw
  - generic.c, 726
- generic\_read\_word
  - generic.c, 726
- generic\_reset
  - generic.c, 727
- generic\_sec\_end
  - generic.c, 727
- generic\_sec\_start
  - generic.c, 727
- generic\_size
  - generic.c, 728
- generic\_status
  - generic.c, 728
- generic\_word\_enabled
  - generic.c, 728
- generic\_write\_byte
  - generic.c, 728
- generic\_write\_hw
  - generic.c, 728
- generic\_write\_word
  - generic.c, 728
- get\_devint\_reg
  - debug-unit.c, 521
- GET\_FIELD
  - fields.h, 724
- get\_func\_len
  - bff, 28
- get\_func\_name
  - bff, 28
- get\_func\_reloc
  - bff, 28
- get\_func\_start
  - bff, 28
- get\_label
  - labels.c, 269
  - labels.h, 271
- GET\_MEDIA\_STATUS
  - atacmd.h, 627
- get\_packet
  - rsp-server.c, 541
- get\_pc
  - common-i386.h, 325
- get\_real\_func\_len
  - archf, 18
- get\_rsp\_char
  - rsp-server.c, 541
- get\_server\_socket
  - gdbcomm.c, 533
- vapi.c, 869
- get\_sp
  - rec-i386.h, 437
- glue
  - dyn-rec.h, 353
  - op-1t-op.h, 393
  - op-2t-op.h, 395
  - op-3t-op.h, 397
  - op-extend-op.h, 401
  - op-ff1-op.h, 402
  - op-mac-op.h, 405
  - op-swhb-op.h, 411
  - op-t-reg-mov-op.h, 415
- gpio.c
  - GPIO\_NUM\_VAPI\_IDS, 735
  - GPIO\_VAPI\_AUX, 735
  - GPIO\_VAPI\_CLOCK, 735
  - GPIO\_VAPI\_DATA, 735
  - GPIO\_VAPI\_RGPIO\_AUX, 735
  - GPIO\_VAPI\_RGPIO\_CTRL, 735
  - GPIO\_VAPI\_RGPIO\_INTE, 735
  - GPIO\_VAPI\_RGPIO\_OE, 735
  - GPIO\_VAPI\_RGPIO\_PTRIG, 735
  - GPIO\_ADDR\_SPACE, 735
  - gpio\_base\_vapi\_id, 736
  - gpio\_baseaddr, 736
  - gpio\_clock, 736
  - gpio\_device\_clock, 736
  - gpio\_do\_int, 736
  - gpio\_enabled, 737
  - gpio\_external\_clock, 737
  - gpio\_irq, 737
  - gpio\_read32, 738
  - gpio\_reset, 738
  - gpio\_sec\_end, 738
  - gpio\_sec\_start, 738
  - gpio\_status, 739
  - gpio\_vapi\_read, 739
  - gpio\_write32, 739
  - reg\_gpio\_sec, 739
  - RGPIO\_AUX, 735
  - RGPIO\_CTRL, 735
  - RGPIO\_CTRL\_ECLK, 735
  - RGPIO\_CTRL\_INTE, 735
  - RGPIO\_CTRL\_INTS, 735
  - RGPIO\_CTRL\_NEC, 735
  - RGPIO\_IN, 735
  - RGPIO\_INTE, 735
  - RGPIO\_INTS, 735
  - RGPIO\_OE, 735
  - RGPIO\_OUT, 735
  - RGPIO\_PTRIG, 735
- gpio.h
  - reg\_gpio\_sec, 740

- GPIO\_NUM\_VAPI\_IDS
  - gpio.c, 735
- GPIO\_VAPI\_AUX
  - gpio.c, 735
- GPIO\_VAPI\_CLOCK
  - gpio.c, 735
- GPIO\_VAPI\_DATA
  - gpio.c, 735
- GPIO\_VAPI\_RGPIIO\_AUX
  - gpio.c, 735
- GPIO\_VAPI\_RGPIIO\_CTRL
  - gpio.c, 735
- GPIO\_VAPI\_RGPIIO\_INTE
  - gpio.c, 735
- GPIO\_VAPI\_RGPIIO\_OE
  - gpio.c, 735
- GPIO\_VAPI\_RGPIIO\_PTRIG
  - gpio.c, 735
- GPIO\_ADDR\_SPACE
  - gpio.c, 735
- gpio\_base\_vapi\_id
  - gpio.c, 736
- gpio\_baseaddr
  - gpio.c, 736
- gpio\_clock
  - gpio.c, 736
- gpio\_device, 123
  - aux, 124
  - auxiliary\_inputs, 124
  - base\_vapi\_id, 124
  - baseaddr, 124
  - ctrl, 124
  - curr, 124
  - enabled, 124
  - external\_clock, 124
  - gpio\_number, 124
  - in, 124
  - inte, 124
  - ints, 124
  - irq, 124
  - next, 124
  - oe, 124
  - out, 124
  - ptrig, 124
- gpio\_device\_clock
  - gpio.c, 736
- gpio\_do\_int
  - gpio.c, 736
- gpio\_enabled
  - gpio.c, 737
- gpio\_external\_clock
  - gpio.c, 737
- gpio\_irq
  - gpio.c, 737
- gpio\_number
  - gpio\_device, 124
- gpio\_read32
  - gpio.c, 738
- gpio\_reset
  - gpio.c, 738
- gpio\_sec\_end
  - gpio.c, 738
- gpio\_sec\_start
  - gpio.c, 738
- gpio\_status
  - gpio.c, 739
- gpio\_vapi\_read
  - gpio.c, 739
- gpio\_write32
  - gpio.c, 739
- GPR\_T
  - def-op-t.h, 327
- group\_bits
  - mprofiler.c, 591
- handle\_rsp
  - rsp-server.c, 542
  - rsp-server.h, 561
- handle\_server\_socket
  - gdbcomm.c, 533
  - gdbcomm.h, 535
- handle\_sim\_command
  - sim-cmd.c, 788
  - sim-cmd.h, 802
- handler\_fits\_id
  - vapi.c, 870
- has\_breakpoint
  - labels.c, 269
  - labels.h, 271
- hash
  - mprofiler.c, 591
- hash0
  - eth\_device, 113
- hash1
  - eth\_device, 113
- hash\_add
  - mprofiler.c, 590
- HASH\_FUNC
  - mprofiler.c, 590
- hash\_get
  - mprofiler.c, 590
- HASH\_SIZE
  - mprofiler.c, 590
- hazards
  - config, 55
- hazardwait
  - runtime, 165
- head

- channel.c, 664
- heads
  - ata\_device, 22
- heads\_per\_cylinder
  - ata\_device, 22
- height
  - INFOHEADER, 131
- hex
  - rsp-server.c, 543
- hex2ascii
  - rsp-server.c, 544
- hex2reg
  - rsp-server.c, 544
- hexchars
  - rsp-server.c, 559
- hide\_device\_id
  - config, 55
- high32
  - common-i386.h, 325
- hist\_exec, 125
  - addr, 125
  - next, 125
  - prev, 125
- hist\_exec\_tail
  - abstract.h, 243
  - execute.c, 375
  - execute.h, 267
- HISTEXEC\_LEN
  - abstract.h, 231
- history
  - config, 55
- hit
  - bpbstat, 31
  - bticstat, 35
- hitdelay
  - config, 55
  - dmmu, 86
  - ic, 127
  - immu, 129
- hlen
  - vga\_state, 180
- host
  - ata\_device, 22
- host\_len
  - dyn\_page, 89
- host\_page
  - dyn\_page, 89
- htim
  - vga\_state, 180
- htoml
  - generic.c, 728
- htoms
  - generic.c, 729
- hush
  - runtime, 165
- hw\_enabled
  - dev\_generic, 77
- i386-regs.h
  - CPU\_STATE\_REG, 380
  - NUM\_T\_REGS, 380
  - T0\_REG, 380
  - T1\_REG, 380
  - T2\_REG, 380
- i386\_gen\_func\_reloc
  - dyngen-i386.c, 360
- i386\_gen\_reloc
  - dyngen-i386.c, 360
- i386\_get\_real\_func\_len
  - dyngen-i386.c, 360
- IADDR\_PAGE
  - immu.h, 587
- ic, 126
  - block\_mask, 127
  - block\_offset\_mask, 127
  - blocksize, 127
  - blocksize\_log2, 127
  - enabled, 127
  - hitdelay, 127
  - last\_way, 127
  - lrus, 127
  - mem, 127
  - missdelay, 127
  - nsets, 127
  - nways, 127
  - set\_mask, 127
  - tagaddr\_mask, 127
  - tags, 127
  - ustates, 127
  - ustates\_reload, 127
- ic\_blocksize
  - icache-model.c, 199
- ic\_enabled
  - icache-model.c, 199
- ic\_end\_sec
  - icache-model.c, 199
- ic\_hitdelay
  - icache-model.c, 200
- ic\_info
  - icache-model.c, 200
- ic\_inv
  - icache-model.c, 200
  - icache-model.h, 204
- ic\_missdelay
  - icache-model.c, 200
- ic\_nsets
  - icache-model.c, 200
- ic\_nways



- icache-model.c, 200
- ic\_simulate\_fetch
  - icache-model.c, 201
  - icache-model.h, 204
- ic\_start\_sec
  - icache-model.c, 201
- ic\_state
  - icache-model.c, 202
  - icache-model.h, 205
- ic\_stats
  - stats.c, 282
  - stats.h, 285
- ic\_ustates
  - icache-model.c, 201
- icache-model.c
  - ic\_blocksize, 199
  - ic\_enabled, 199
  - ic\_end\_sec, 199
  - ic\_hitdelay, 200
  - ic\_info, 200
  - ic\_inv, 200
  - ic\_missdelay, 200
  - ic\_nsets, 200
  - ic\_nways, 200
  - ic\_simulate\_fetch, 201
  - ic\_start\_sec, 201
  - ic\_state, 202
  - ic\_ustates, 201
  - MAX\_IC\_BLOCK\_SIZE, 199
  - MAX\_IC\_SETS, 199
  - MAX\_IC\_WAYS, 199
  - MIN\_IC\_BLOCK\_SIZE, 199
  - reg\_ic\_sec, 202
- icache-model.h
  - ic\_inv, 204
  - ic\_simulate\_fetch, 204
  - ic\_state, 205
  - reg\_ic\_sec, 204
- icomplet
  - cpu\_state, 60
- IDENTIFY\_DEVICE
  - atacmd.h, 627
- IDENTIFY\_PACKET\_DEVICE
  - atacmd.h, 627
- identifyfile
  - parse.c, 273
- IDLE
  - atacmd.h, 627
- IDLE\_IMMEDIATE
  - atacmd.h, 627
- ier
  - dev\_16450, 74
- ifr
  - eth\_device, 113
- II\_ADD
  - insn.h, 490
- II\_AND
  - insn.h, 490
- II\_BF
  - insn.h, 490
- II\_CALL
  - insn.h, 490
- II\_CMOV
  - insn.h, 490
- II\_IS\_LOAD
  - insn.h, 490
- II\_IS\_STORE
  - insn.h, 490
- II\_LAST
  - insn.h, 490
- II\_LB
  - insn.h, 490
- II\_LH
  - insn.h, 490
- II\_LRBB
  - insn.h, 490
- II\_LW
  - insn.h, 490
- II\_MASK
  - insn.h, 490
- II\_MEM
  - insn.h, 490
- II\_MEM\_WIDTH
  - insn.h, 490
- II\_MUL
  - insn.h, 490
- II\_NOP
  - insn.h, 492
- II\_OR
  - insn.h, 492
- II\_REG
  - insn.h, 492
- II\_SB
  - insn.h, 492
- II\_SFEQ
  - insn.h, 492
- II\_SFGE
  - insn.h, 492
- II\_SFGT
  - insn.h, 492
- II\_SFLE
  - insn.h, 492
- II\_SFLT
  - insn.h, 492
- II\_SFNE
  - insn.h, 492
- II\_SH
  - insn.h, 492

- II\_SIGNED
  - insn.h, 492
- ii\_size
  - insn.h, 492
  - timings.c, 508
- II\_SLL
  - insn.h, 492
- II\_SRA
  - insn.h, 492
- II\_SRL
  - insn.h, 492
- II\_SUB
  - insn.h, 492
- II\_SW
  - insn.h, 492
- II\_XOR
  - insn.h, 492
- iir
  - dev\_16450, 74
- imagesize
  - INFOHEADER, 131
- imm\_gen\_op
  - dyn-rec.c, 335
- IMM\_STATS
  - parse.c, 273
- immu, 128
  - enabled, 129
  - entrysize, 129
  - hitdelay, 129
  - lru\_reload, 129
  - missdelay, 129
  - nsets, 129
  - nways, 129
  - page\_mask, 129
  - page\_offset\_mask, 129
  - pagesize, 129
  - pagesize\_log2, 129
  - set\_mask, 129
  - ustates, 129
  - vpn\_mask, 129
- immu.c
  - immu\_enabled, 582
  - immu\_end\_sec, 582
  - immu\_entrysize, 582
  - immu\_find\_tlbmr, 582
  - immu\_hitdelay, 583
  - immu\_missdelay, 583
  - immu\_nsets, 583
  - immu\_nways, 583
  - immu\_pagesize, 583
  - immu\_start\_sec, 584
  - immu\_state, 585
  - immu\_translate, 584
  - immu\_ustates, 584
- itlb\_status, 584
- peek\_into\_itlb, 585
- reg\_immu\_sec, 585
- immu.h
  - IADDR\_PAGE, 587
  - immu\_simulate\_tlb, 587
  - immu\_state, 588
  - immu\_translate, 587
  - peek\_into\_itlb, 587
  - reg\_immu\_sec, 587
- immu\_enabled
  - immu.c, 582
- immu\_end\_sec
  - immu.c, 582
- immu\_entrysize
  - immu.c, 582
- immu\_find\_tlbmr
  - immu.c, 582
- IMMU\_GOT\_DISABLED
  - dyn-rec.h, 353
- IMMU\_GOT\_ENABLED
  - dyn-rec.h, 353
- immu\_hitdelay
  - immu.c, 583
- immu\_missdelay
  - immu.c, 583
- immu\_nsets
  - immu.c, 583
- immu\_nways
  - immu.c, 583
- immu\_pagesize
  - immu.c, 583
- immu\_retranslate
  - dyn-rec.c, 347
- immu\_simulate\_tlb
  - immu.h, 587
- immu\_start\_sec
  - immu.c, 584
- immu\_state
  - immu.c, 585
  - immu.h, 588
- immu\_stats
  - stats.c, 282
  - stats.h, 285
- immu\_translate
  - immu.c, 584
  - immu.h, 587
- immu\_ustates
  - immu.c, 584
- immustats\_entry, 130
  - fetch\_pagefaults, 130
  - fetch\_tlbhit, 130
  - fetch\_tlbmiss, 130
- importantcolours

- INFOHEADER, 131
- in
  - gpio\_device, 124
- in\_file
  - generate.c, 379
- in\_refresh
  - fb\_state, 118
- in\_reset
  - debug-unit.c, 523
- incorrect
  - bpbstat, 31
- index
  - cuc\_insn, 65
  - mc, 147
- INFOHEADER, 131
  - bits, 131
  - compression, 131
  - height, 131
  - imagesize, 131
  - importantcolours, 131
  - ncolours, 131
  - planes, 131
  - size, 131
  - width, 131
  - xresolution, 131
  - yresolution, 131
- init
  - channel\_ops, 39
  - mprofiler.c, 590
- init\_bb\_reloc
  - \_cuc\_func, 16
- init\_breakpoints
  - labels.c, 269
  - labels.h, 271
- init\_defconfig
  - sim-config.c, 805
  - sim-config.h, 814
- init\_dyn\_recomp
  - dyn-rec.c, 348
  - dyn-rec.h, 354
- init\_labels
  - labels.c, 269
  - labels.h, 271
- INITIALIZE\_DEVICE\_PARAMETERS
  - atacmd.h, 627
- initstats
  - stats.c, 281
  - stats.h, 285
- insert\_conditional\_facts
  - adv.c, 441
  - cuc.h, 473
- insert\_insns
  - cuc.h, 474
  - insn.c, 485
- INSN
  - cuc.h, 469
- insn
  - btic\_entry, 34
  - cuc.h, 481
  - cuc\_bb, 63
  - cuc\_insn, 65
  - iqueue\_entry, 132
  - load.c, 498
  - op\_queue, 158
  - sstats\_entry, 174
- insn.c
  - add\_data\_dep, 483
  - add\_dep, 483
  - add\_latches, 483
  - apply\_edge\_condition, 483
  - change\_insn\_type, 484
  - cmov\_needed, 484
  - count\_cmovs, 484
  - cse, 484
  - csm, 484
  - csm\_gen, 484
  - cuc\_insn\_name, 484
  - dispose\_list, 485
  - insert\_insns, 485
  - insn\_uses, 485
  - iteration, 487
  - known, 487
  - main\_list, 487
  - optimize\_cmov\_more, 485
  - optimize\_cmovs, 485
  - optimize\_tree, 485
  - print\_insns, 486
  - print\_shared, 486
  - remove\_dead, 486
  - remove\_nops, 486
  - remove\_trivial\_regs, 487
  - search\_csm, 487
  - set\_io, 487
  - tmp\_op, 487
  - tmp\_opt, 487
  - unmark\_tree, 487
- insn.h
  - change\_insn\_type, 492
  - cuc\_insn\_name, 492
  - II\_ADD, 490
  - II\_AND, 490
  - II\_BF, 490
  - II\_CALL, 490
  - II\_CMOV, 490
  - II\_IS\_LOAD, 490
  - II\_IS\_STORE, 490
  - II\_LAST, 490
  - II\_LB, 490

- II\_LH, 490
- II\_LRBB, 490
- II\_LW, 490
- II\_MASK, 490
- II\_MEM, 490
- II\_MEM\_WIDTH, 490
- II\_MUL, 490
- II\_NOP, 492
- II\_OR, 492
- II\_REG, 492
- II\_SB, 492
- II\_SFEQ, 492
- II\_SFGE, 492
- II\_SFGT, 492
- II\_SFLE, 492
- II\_SFLT, 492
- II\_SFNE, 492
- II\_SH, 492
- II\_SIGNED, 492
- ii\_size, 492
- II\_SLL, 492
- II\_SRA, 492
- II\_SRL, 492
- II\_SUB, 492
- II\_SW, 492
- II\_XOR, 492
- insn\_size, 492
- insn\_time, 492
- known, 493
- load\_timing\_table, 492
- print\_shared, 492
- insn1
  - dstats\_entry, 88
  - fstats\_entry, 121
- insn2
  - dstats\_entry, 88
  - fstats\_entry, 121
- insn\_addr
  - iqueue\_entry, 132
  - op\_queue, 158
- insn\_ci
  - abstract.c, 228
  - abstract.h, 243
- insn\_decode
  - or32.c, 433
- insn\_ea
  - cpu\_state, 60
- insn\_extract
  - or32.c, 434
- insn\_index
  - iqueue\_entry, 132
  - op\_queue, 158
  - or32.c, 434
- insn\_indexs
  - dyn\_page, 89
- insn\_len
  - or32.c, 434
- insn\_name
  - or32.c, 434
- insn\_size
  - insn.h, 492
  - timings.c, 509
- insn\_time
  - insn.h, 492
  - timings.c, 509
- insn\_uses
  - insn.c, 485
- INSNAME\_LEN
  - abstract.h, 231
- insns
  - dyn\_page, 89
- insnset.c
  - INSTRUCTION, 384–392
- instr
  - mp\_entry, 154
- INSTRUCTION
  - insnset.c, 384–392
- instructions
  - runtime, 165
- int\_mask
  - eth\_device, 113
- int\_msk\_a
  - dma\_controller, 84
- int\_msk\_b
  - dma\_controller, 84
- int\_source
  - eth\_device, 113
- int\_src\_a
  - dma\_controller, 84
- int\_src\_b
  - dma\_controller, 84
- int\_val
  - param\_val, 159
- inte
  - gpio\_device, 124
- internal\_or1ksim\_time
  - libtoplevel.c, 565
- internals
  - ata\_device, 22
- intrq
  - ata\_device, 22
- ints
  - dev\_16450, 74
  - gpio\_device, 124
- iordy
  - ata\_device, 22
- ipgr1
  - eth\_device, 113

- ipgr2
  - eth\_device, 113
- ipgt
  - eth\_device, 113
- iprompt
  - runtime, 165
- iprompt\_run
  - runtime, 165
- iqueue
  - cpu\_state, 61
- iqueue\_entry, 132
  - insn, 132
  - insn\_addr, 132
  - insn\_index, 132
- iregs
  - dev\_16450, 74
- irq
  - ata\_host, 26
  - dev\_16450, 74
  - dma\_controller, 84
  - gpio\_device, 124
  - kbd\_state, 144
  - vga\_state, 180
- is\_ata\_hostadr
  - atahost.h, 660
- is\_power2
  - misc.c, 830
  - misc.h, 831
- isblank
  - isblank.c, 777
  - port.h, 778
- isblank.c
  - isblank, 777
- isok
  - channel\_ops, 39
- issued\_per\_cycle
  - execute.c, 376
- istat
  - dev\_16450, 74
- IT\_BBEND
  - cuc.h, 469
- IT\_BBSTART
  - cuc.h, 469
- IT\_BRANCH
  - cuc.h, 469
- IT\_COND
  - cuc.h, 469
- IT\_CUT
  - cuc.h, 469
- IT\_FLAG1
  - cuc.h, 469
- IT\_FLAG2
  - cuc.h, 469
- IT\_INDELAY
  - cuc.h, 469
- IT\_LATCHED
  - cuc.h, 469
- IT\_MEMADD
  - cuc.h, 469
- IT\_MEMORY
  - cuc.h, 469
- IT\_OUTPUT
  - cuc.h, 469
- IT\_SIGNED
  - cuc.h, 469
- IT\_UNUSED
  - cuc.h, 469
- IT\_VOLATILE
  - cuc.h, 469
- iteration
  - insn.c, 487
- itlb\_status
  - immu.c, 584
- jitter
  - dev\_16450, 74
- job\_queue
  - scheduler\_struct, 168
- join\_bb
  - bb.c, 444
- join\_transfers
  - cuc/memory.c, 500
- JTAG\_CHAIN\_DEBUG\_UNIT
  - debug-unit.h, 524
- JTAG\_CHAIN\_DEVELOPMENT
  - debug-unit.h, 524
- JTAG\_CHAIN\_GLOBAL
  - debug-unit.h, 524
- JTAG\_CHAIN\_TRACE
  - debug-unit.h, 524
- JTAG\_CHAIN\_WISHBONE
  - debug-unit.h, 524
- JTAG\_PROXY\_ACCESS\_EXCEPTION
  - gdb.h, 530
- JTAG\_PROXY\_COMMAND\_NOT\_-  
IMPLEMENTED
  - gdb.h, 530
- JTAG\_PROXY\_INVALID\_ADDRESS
  - gdb.h, 530
- JTAG\_PROXY\_INVALID\_CHAIN
  - gdb.h, 530
- JTAG\_PROXY\_INVALID\_COMMAND
  - gdb.h, 530
- JTAG\_PROXY\_INVALID\_LENGTH
  - gdb.h, 530
- JTAG\_PROXY\_NO\_CONNECTION
  - gdb.h, 530
- JTAG\_PROXY\_OUT\_OF\_MEMORY

- gdb.h, 530
- JTAG\_PROXY\_PROTOCOL\_ERROR
  - gdb.h, 530
- JTAG\_PROXY\_SERVER\_TERMINATED
  - gdb.h, 530
- jtag\_request
  - gdbcomm.c, 533
- jtr\_chain\_message, 133
  - chain, 133
  - command, 133
  - length, 133
- jtr\_chain\_response, 134
  - status, 134
- jtr\_failure\_response, 135
  - status, 135
- jtr\_read\_block\_message, 136
  - address, 136
  - command, 136
  - length, 136
  - num\_regs, 136
- jtr\_read\_block\_response, 137
  - data, 137
  - num\_regs, 137
  - status, 137
- jtr\_read\_message, 138
  - address, 138
  - command, 138
  - length, 138
- jtr\_read\_response, 139
  - data\_h, 139
  - data\_l, 139
  - status, 139
- jtr\_write\_block\_message, 140
  - address, 140
  - command, 140
  - data, 140
  - length, 140
  - num\_regs, 140
- jtr\_write\_block\_response, 141
  - status, 141
- jtr\_write\_message, 142
  - address, 142
  - command, 142
  - data\_h, 142
  - data\_l, 142
  - length, 142
- jtr\_write\_response, 143
  - status, 143
- jump\_local
  - op\_queue, 158
- jump\_local\_loc
  - op\_queue, 158
- kbd\_baseaddr
  - ps2kbd.c, 756
- KBD\_BAUD\_RATE
  - ps2kbd.c, 756
- KBD\_CCMD\_DKI
  - ps2kbd.c, 756
- KBD\_CCMD\_EKI
  - ps2kbd.c, 756
- KBD\_CCMD\_RCB
  - ps2kbd.c, 756
- KBD\_CCMD\_ST1
  - ps2kbd.c, 756
- KBD\_CCMD\_ST2
  - ps2kbd.c, 756
- KBD\_CCMD\_WCB
  - ps2kbd.c, 756
- KBD\_CCMDBYTE\_EN
  - ps2kbd.c, 756
- KBD\_CCMDBYTE\_EN2
  - ps2kbd.c, 756
- KBD\_CCMDBYTE\_INT
  - ps2kbd.c, 756
- KBD\_CCMDBYTE\_INT2
  - ps2kbd.c, 756
- KBD\_CCMDBYTE\_SYS
  - ps2kbd.c, 756
- KBD\_CCMDBYTE\_XLAT
  - ps2kbd.c, 756
- KBD\_CTRL
  - ps2kbd.c, 756
- KBD\_DATA
  - ps2kbd.c, 756
- kbd\_enabled
  - ps2kbd.c, 756
- kbd\_info
  - ps2kbd.c, 756
- kbd\_irq
  - ps2kbd.c, 756
- kbd\_job
  - ps2kbd.c, 756
- KBD\_KCMD\_DK
  - ps2kbd.c, 756
- KBD\_KCMD\_ECHO
  - ps2kbd.c, 756
- KBD\_KCMD\_EK
  - ps2kbd.c, 756
- KBD\_KCMD\_RST
  - ps2kbd.c, 756
- KBD\_KCMD\_SRL
  - ps2kbd.c, 756
- KBD\_KRESP\_ACK
  - ps2kbd.c, 756
- KBD\_KRESP\_ECHO
  - ps2kbd.c, 756
- KBD\_KRESP\_RSTOK

- ps2kbd.c, 756
- KBD\_MAX\_BUF
  - ps2kbd.c, 756
- kbd\_put
  - ps2kbd.c, 757
- kbd\_read8
  - ps2kbd.c, 757
- kbd\_reset
  - ps2kbd.c, 757
- kbd\_rxfile
  - ps2kbd.c, 757
- kbd\_sec\_end
  - ps2kbd.c, 757
- kbd\_sec\_start
  - ps2kbd.c, 758
- KBD\_SPACE
  - ps2kbd.c, 756
- kbd\_state, 144
  - baseaddr, 144
  - buf, 144
  - buf\_count, 144
  - buf\_head, 144
  - buf\_tail, 144
  - ccmd, 144
  - ccmdbyte, 144
  - enabled, 144
  - irq, 144
  - kcmd, 144
  - kresp, 144
  - rxfile, 144
  - rxfs, 144
  - slowdown, 144
- KBD\_STATUS\_A2
  - ps2kbd.c, 756
- KBD\_STATUS\_IBF
  - ps2kbd.c, 756
- KBD\_STATUS\_INH
  - ps2kbd.c, 756
- KBD\_STATUS\_MOBF
  - ps2kbd.c, 756
- KBD\_STATUS\_OBF
  - ps2kbd.c, 756
- KBD\_STATUS\_PERR
  - ps2kbd.c, 756
- KBD\_STATUS\_SYS
  - ps2kbd.c, 756
- KBD\_STATUS\_TO
  - ps2kbd.c, 756
- kbd\_write8
  - ps2kbd.c, 758
- kcmd
  - kbd\_state, 144
- KEEP\_ENDIAN\_LONG
  - coff.h, 249
- KEEP\_ENDIAN\_SHORT
  - coff.h, 250
- known
  - insn.c, 487
  - insn.h, 493
- kresp
  - kbd\_state, 144
- l\_addr
  - COFF\_lineno, 46
- l\_invalid
  - execute.c, 374
- l\_inno
  - COFF\_lineno, 46
- l\_none
  - dyn32-defs.h, 357
  - or32.c, 434
- l\_paddr
  - COFF\_lineno, 46
- l\_symndx
  - COFF\_lineno, 46
- label\_entry, 145
  - addr, 145
  - name, 145
  - next, 145
- label\_hash
  - labels.c, 269
- LABELEND\_CHAR
  - dumpverilog.c, 826
- LABELNAME\_LEN
  - abstract.h, 231
- labels.c
  - add\_breakpoint, 269
  - add\_label, 269
  - breakpoints, 269
  - eval\_label, 269
  - find\_label, 269
  - get\_label, 269
  - has\_breakpoint, 269
  - init\_breakpoints, 269
  - init\_labels, 269
  - label\_hash, 269
  - LABELS\_HASH\_SIZE, 269
  - print\_breakpoints, 269
  - remove\_breakpoint, 269
- labels.h
  - add\_breakpoint, 271
  - add\_label, 271
  - breakpoints, 271
  - eval\_label, 271
  - find\_label, 271
  - get\_label, 271
  - has\_breakpoint, 271
  - init\_breakpoints, 271

- init\_labels, 271
- print\_breakpoints, 271
- remove\_breakpoint, 271
- LABELS\_HASH\_SIZE
  - labels.c, 269
- last
  - cuc\_bb, 63
- last\_used\_reg
  - cuc\_bb, 63
- last\_way
  - ic, 127
- lba
  - ata\_device, 22
- lcr
  - dev\_16450, 74
- LE16
  - abstract.h, 231
- len
  - rsp\_buf, 162
- length
  - jtr\_chain\_message, 133
  - jtr\_read\_block\_message, 136
  - jtr\_read\_message, 138
  - jtr\_write\_block\_message, 140
  - jtr\_write\_message, 142
- letter\_range
  - or32.c, 434
- letter\_signed
  - or32.c, 434
- libtoplevel.c, 564
  - internal\_or1ksim\_time, 565
  - or1ksim\_clock\_rate, 565
  - or1ksim\_get\_time\_period, 565
  - or1ksim\_init, 565
  - or1ksim\_interrupt, 568
  - or1ksim\_interrupt\_clear, 568
  - or1ksim\_interrupt\_set, 568
  - or1ksim\_is\_le, 568
  - or1ksim\_reset\_duration, 568
  - or1ksim\_run, 569
  - or1ksim\_set\_time\_point, 569
- line
  - dc\_set, 70
- LINK\_REGNO
  - arch.h, 290
- lo\_buff
  - eth\_device, 113
- load.c
  - build\_insn, 495
  - conv, 498
  - cuc\_load, 495
  - detect\_locals, 496
  - expand\_branch, 496
  - expand\_calls, 496
  - expand\_memory, 497
  - expand\_signed, 497
  - insn, 498
  - negate\_conditional, 497
  - num\_insn, 498
  - print\_cuc\_insns, 497
  - reloc, 498
  - remove\_dslots, 497
  - xchg\_insn, 497
- load\_hitdelay
  - config, 55
- load\_missdelay
  - config, 55
- load\_next\_descriptor\_when\_done
  - dma\_channel, 81
- load\_timing\_table
  - insn.h, 492
  - timings.c, 509
- loadcode
  - parse.c, 274
  - parse.h, 278
- loadcycles
  - runtime, 165
- loads\_pagefaults
  - dmmustats\_entry, 87
- loads\_tlbhit
  - dmmustats\_entry, 87
- loads\_tlbmiss
  - dmmustats\_entry, 87
- locs
  - dyn\_page, 89
- log
  - cuc.h, 469
  - dev\_memarea, 79
  - mem\_config, 150
  - mem\_ops, 152
- log2\_int
  - misc.c, 830
  - misc.h, 831
- log\_enabled
  - config, 55
- LONGEST
  - abstract.h, 231
- longlong\_val
  - param\_val, 159
- loopback
  - dev\_16450, 74
- loopback\_offset
  - eth\_device, 113
- low32
  - common-i386.h, 325
- LRBB\_REG
  - cuc.h, 469
- lru



- bpb\_entry, 30
  - btic\_entry, 34
  - dc\_set, 70
- lru\_reload
  - dmmu, 86
  - immu, 129
- lrus
  - ic, 127
- LS\_OP\_CAST
  - op.c, 423
- LS\_OP\_FUNC
  - op.c, 423
- LS\_OP\_NAME
  - op.c, 423
- lsr
  - dev\_16450, 74
- lur
  - \_cuc\_func, 16
- mac\_address
  - eth\_device, 113
- mac\_int
  - eth\_device, 113
- magic
  - COFF\_AOUTHDR, 40
- main
  - dyngen.c, 363
  - generate.c, 378
  - toplevel-mprofile.c, 850
  - toplevel-profile.c, 853
  - toplevel.c, 865
- main\_cuc
  - cuc.c, 457
  - cuc.h, 474
- main\_list
  - insn.c, 487
- main\_mprofiler
  - mprofiler.c, 590
  - mprofiler.h, 593
- main\_profiler
  - profiler.c, 781
  - profiler.h, 784
- mainpage, 571
- mark\_cut
  - cuc.h, 477
  - timings.c, 509
- mark\_successors
  - adv.c, 441
- mask
  - adv.c, 441
  - spr\_bit\_def, 172
- masked\_increase
  - dma.c, 696
- MATCHPOINTS\_TO\_NDP
  - spr-defs.h, 305
- MAX
  - cuc.h, 469
- max
  - cuc\_insn, 65
- MAX\_AUTOMATA\_SIZE
  - or32.c, 432
- MAX\_BB
  - cuc.h, 469
- max\_bb\_delay
  - timings.c, 509
- MAX\_DC\_BLOCK\_SIZE
  - dcache-model.h, 196
- MAX\_DC\_SETS
  - dcache-model.h, 196
- MAX\_DC\_WAYS
  - dcache-model.h, 196
- max\_delay
  - timings.c, 509
- MAX\_FUNCS
  - profiler.h, 784
- MAX\_GRPS
  - spr-defs.h, 305
- MAX\_IC\_BLOCK\_SIZE
  - icache-model.c, 199
- MAX\_IC\_SETS
  - icache-model.c, 199
- MAX\_IC\_WAYS
  - icache-model.c, 199
- MAX\_INSNS
  - cuc.h, 469
- MAX\_LEN
  - or32.c, 432
- MAX\_MATCHPOINTS
  - spr-defs.h, 307
- max\_op
  - adv.c, 441
- MAX\_OP\_TABLE\_SIZE
  - or32.c, 432
- MAX\_OPERANDS
  - abstract.h, 231
- MAX\_PARAMS
  - dyngen.c, 363
- MAX\_PREROLL
  - cuc.h, 469
- MAX\_REGS
  - cuc.h, 469
- MAX\_SBUF\_LEN
  - sim-config.h, 813
- MAX\_SKEW
  - 16450.c, 601
- MAX\_SPRS
  - spr-defs.h, 307
- MAX\_SPRS\_PER\_GRP

- spr-defs.h, 307
- MAX\_SPRS\_PER\_GRP\_BITS
  - spr-defs.h, 307
- MAX\_STACK
  - profiler.c, 781
- MAX\_UNROLL
  - cuc.h, 469
- MAX\_WATCHPOINTS
  - spr-defs.h, 307
- MAX\_XTERM\_ARGS
  - xterm.c, 679
- maximum\_length
  - eth\_device, 113
- maxstack
  - profiler.c, 782
- mc, 146
  - ba\_mask, 147
  - baseaddr, 147
  - csc, 147
  - csr, 147
  - enabled, 147
  - index, 147
  - mc\_areas, 147
  - mc\_area, 148
  - mem\_config, 150
  - next, 147
  - poc, 147
  - tms, 147
- mc.c
  - MC\_ADDR\_SPACE, 745
  - mc\_areas, 748
  - MC\_BA\_MASK, 745
  - MC\_BA\_MASK\_VALID, 745
  - mc\_baseaddr, 745
  - MC\_CSC, 745
  - MC\_CSC\_BAS\_OFFSET, 745
  - MC\_CSC\_BW\_OFFSET, 745
  - MC\_CSC\_BW\_WIDTH, 745
  - MC\_CSC\_EN\_OFFSET, 745
  - MC\_CSC\_KRO\_OFFSET, 745
  - MC\_CSC\_MEMTYPE\_ASYNC, 745
  - MC\_CSC\_MEMTYPE\_OFFSET, 745
  - MC\_CSC\_MEMTYPE\_SDRAM, 745
  - MC\_CSC\_MEMTYPE\_SSRAM, 745
  - MC\_CSC\_MEMTYPE\_SYNC, 745
  - MC\_CSC\_MEMTYPE\_WIDTH, 745
  - MC\_CSC\_MS\_OFFSET, 745
  - MC\_CSC\_MS\_WIDTH, 745
  - MC\_CSC\_PEN\_OFFSET, 745
  - MC\_CSC\_SEL\_OFFSET, 745
  - MC\_CSC\_SEL\_WIDTH, 745
  - MC\_CSC\_VALID, 745
  - MC\_CSC\_WP\_OFFSET, 745
  - MC\_CSR, 745
  - MC\_CSR\_VALID, 745
  - mc\_done, 745
  - mc\_enabled, 745
  - mc\_index, 746
  - MC\_POC, 745
  - mc\_poc, 746
  - MC\_POC\_EN\_BW\_OFFSET, 745
  - MC\_POC\_EN\_BW\_WIDTH, 745
  - MC\_POC\_EN\_MEMTYPE\_OFFSET, 745
  - MC\_POC\_EN\_MEMTYPE\_WIDTH, 745
  - MC\_POC\_VALID, 745
  - mc\_read\_word, 746
  - mc\_reg\_mem\_area, 746
  - mc\_reset, 746
  - mc\_sec\_end, 746
  - mc\_sec\_start, 747
  - mc\_status, 747
  - MC\_TMS, 745
  - MC\_TMS\_ASYNC\_TRDV\_OFFSET, 745
  - MC\_TMS\_ASYNC\_TRDV\_WIDTH, 745
  - MC\_TMS\_ASYNC\_TRDZ\_OFFSET, 745
  - MC\_TMS\_ASYNC\_TRDZ\_WIDTH, 745
  - MC\_TMS\_ASYNC\_TWD\_OFFSET, 745
  - MC\_TMS\_ASYNC\_TWD\_WIDTH, 745
  - MC\_TMS\_ASYNC\_TWPW\_OFFSET, 745
  - MC\_TMS\_ASYNC\_TWPW\_WIDTH, 745
  - MC\_TMS\_ASYNC\_TWWD\_OFFSET, 745
  - MC\_TMS\_ASYNC\_TWWD\_WIDTH, 745
  - MC\_TMS\_ASYNC\_VALID, 745
  - MC\_TMS\_SDRAM\_BL\_OFFSET, 745
  - MC\_TMS\_SDRAM\_BL\_WIDTH, 745
  - MC\_TMS\_SDRAM\_BT\_OFFSET, 745
  - MC\_TMS\_SDRAM\_CL\_OFFSET, 745
  - MC\_TMS\_SDRAM\_CL\_WIDTH, 745
  - MC\_TMS\_SDRAM\_OM\_OFFSET, 745
  - MC\_TMS\_SDRAM\_OM\_WIDTH, 745
  - MC\_TMS\_SDRAM\_TRCD\_OFFSET, 745
  - MC\_TMS\_SDRAM\_TRCD\_WIDTH, 745
  - MC\_TMS\_SDRAM\_TRFC\_OFFSET, 745
  - MC\_TMS\_SDRAM\_TRFC\_WIDTH, 745
  - MC\_TMS\_SDRAM\_TRP\_OFFSET, 745
  - MC\_TMS\_SDRAM\_TRP\_WIDTH, 745
  - MC\_TMS\_SDRAM\_TWR\_OFFSET, 745
  - MC\_TMS\_SDRAM\_TWR\_WIDTH, 745
  - MC\_TMS\_SDRAM\_VALID, 745
  - MC\_TMS\_SDRAM\_WBL\_OFFSET, 745
  - MC\_TMS\_SSRAM\_VALID, 745
  - MC\_TMS\_SYNC\_TRDV\_OFFSET, 745
  - MC\_TMS\_SYNC\_TRDV\_WIDTH, 745
  - MC\_TMS\_SYNC\_TRDZ\_OFFSET, 745
  - MC\_TMS\_SYNC\_TRDZ\_WIDTH, 745
  - MC\_TMS\_SYNC\_TTO\_OFFSET, 745
  - MC\_TMS\_SYNC\_TTO\_WIDTH, 745
  - MC\_TMS\_SYNC\_TWR\_OFFSET, 745

- MC\_TMS\_SYNC\_TWR\_WIDTH, 745
- MC\_TMS\_SYNC\_VALID, 745
- MC\_TMS\_VALID, 745
- mc\_write\_word, 747
- mcs, 748
- N\_CE, 745
- reg\_mc\_sec, 747
- set\_csc\_tms, 748
- mc.h
  - mc\_done, 749
  - mc\_reg\_mem\_area, 749
  - reg\_mc\_sec, 750
- MC\_ADDR\_SPACE
  - mc.c, 745
- mc\_area, 148
  - abstract.c, 228
  - cs, 148
  - mc, 148
  - mem, 148
  - next, 148
- mc\_areas
  - mc, 147
  - mc.c, 748
- MC\_BA\_MASK
  - mc.c, 745
- MC\_BA\_MASK\_VALID
  - mc.c, 745
- mc\_baseaddr
  - mc.c, 745
- MC\_CSC
  - mc.c, 745
- MC\_CSC\_BAS\_OFFSET
  - mc.c, 745
- MC\_CSC\_BW\_OFFSET
  - mc.c, 745
- MC\_CSC\_BW\_WIDTH
  - mc.c, 745
- MC\_CSC\_EN\_OFFSET
  - mc.c, 745
- MC\_CSC\_KRO\_OFFSET
  - mc.c, 745
- MC\_CSC\_MEMTYPE\_ASYNC
  - mc.c, 745
- MC\_CSC\_MEMTYPE\_OFFSET
  - mc.c, 745
- MC\_CSC\_MEMTYPE\_SDRAM
  - mc.c, 745
- MC\_CSC\_MEMTYPE\_SSRAM
  - mc.c, 745
- MC\_CSC\_MEMTYPE\_SYNC
  - mc.c, 745
- MC\_CSC\_MEMTYPE\_WIDTH
  - mc.c, 745
- MC\_CSC\_MS\_OFFSET
  - mc.c, 745
- MC\_CSC\_MS\_WIDTH
  - mc.c, 745
- MC\_CSC\_PEN\_OFFSET
  - mc.c, 745
- MC\_CSC\_SEL\_OFFSET
  - mc.c, 745
- MC\_CSC\_SEL\_WIDTH
  - mc.c, 745
- MC\_CSC\_VALID
  - mc.c, 745
- MC\_CSC\_WP\_OFFSET
  - mc.c, 745
- MC\_CSR
  - mc.c, 745
- MC\_CSR\_VALID
  - mc.c, 745
- mc\_done
  - mc.c, 745
  - mc.h, 749
- mc\_enabled
  - mc.c, 745
- mc\_index
  - mc.c, 746
- MC\_POC
  - mc.c, 745
- mc\_poc
  - mc.c, 746
- MC\_POC\_EN\_BW\_OFFSET
  - mc.c, 745
- MC\_POC\_EN\_BW\_WIDTH
  - mc.c, 745
- MC\_POC\_EN\_MEMTYPE\_OFFSET
  - mc.c, 745
- MC\_POC\_EN\_MEMTYPE\_WIDTH
  - mc.c, 745
- MC\_POC\_VALID
  - mc.c, 745
- mc\_read\_word
  - mc.c, 746
- mc\_reg\_mem\_area
  - mc.c, 746
  - mc.h, 749
- mc\_reset
  - mc.c, 746
- mc\_sec\_end
  - mc.c, 746
- mc\_sec\_start
  - mc.c, 747
- mc\_status
  - mc.c, 747
- MC\_TMS
  - mc.c, 745
- MC\_TMS\_ASYNC\_TRDV\_OFFSET

- mc.c, 745
- MC\_TMS\_ASYNC\_TRDV\_WIDTH
  - mc.c, 745
- MC\_TMS\_ASYNC\_TRDZ\_OFFSET
  - mc.c, 745
- MC\_TMS\_ASYNC\_TRDZ\_WIDTH
  - mc.c, 745
- MC\_TMS\_ASYNC\_TWD\_OFFSET
  - mc.c, 745
- MC\_TMS\_ASYNC\_TWD\_WIDTH
  - mc.c, 745
- MC\_TMS\_ASYNC\_TWPW\_OFFSET
  - mc.c, 745
- MC\_TMS\_ASYNC\_TWPW\_WIDTH
  - mc.c, 745
- MC\_TMS\_ASYNC\_TWWD\_OFFSET
  - mc.c, 745
- MC\_TMS\_ASYNC\_TWWD\_WIDTH
  - mc.c, 745
- MC\_TMS\_ASYNC\_VALID
  - mc.c, 745
- MC\_TMS\_SDRAM\_BL\_OFFSET
  - mc.c, 745
- MC\_TMS\_SDRAM\_BL\_WIDTH
  - mc.c, 745
- MC\_TMS\_SDRAM\_BT\_OFFSET
  - mc.c, 745
- MC\_TMS\_SDRAM\_CL\_OFFSET
  - mc.c, 745
- MC\_TMS\_SDRAM\_CL\_WIDTH
  - mc.c, 745
- MC\_TMS\_SDRAM\_OM\_OFFSET
  - mc.c, 745
- MC\_TMS\_SDRAM\_OM\_WIDTH
  - mc.c, 745
- MC\_TMS\_SDRAM\_TRCD\_OFFSET
  - mc.c, 745
- MC\_TMS\_SDRAM\_TRCD\_WIDTH
  - mc.c, 745
- MC\_TMS\_SDRAM\_TRFC\_OFFSET
  - mc.c, 745
- MC\_TMS\_SDRAM\_TRFC\_WIDTH
  - mc.c, 745
- MC\_TMS\_SDRAM\_TRP\_OFFSET
  - mc.c, 745
- MC\_TMS\_SDRAM\_TRP\_WIDTH
  - mc.c, 745
- MC\_TMS\_SDRAM\_TWR\_OFFSET
  - mc.c, 745
- MC\_TMS\_SDRAM\_TWR\_WIDTH
  - mc.c, 745
- MC\_TMS\_SDRAM\_VALID
  - mc.c, 745
- MC\_TMS\_SDRAM\_WBL\_OFFSET
  - mc.c, 745
- MC\_TMS\_SSRAM\_VALID
  - mc.c, 745
- MC\_TMS\_SYNC\_TRDV\_OFFSET
  - mc.c, 745
- MC\_TMS\_SYNC\_TRDV\_WIDTH
  - mc.c, 745
- MC\_TMS\_SYNC\_TRDZ\_OFFSET
  - mc.c, 745
- MC\_TMS\_SYNC\_TRDZ\_WIDTH
  - mc.c, 745
- MC\_TMS\_SYNC\_TTO\_OFFSET
  - mc.c, 745
- MC\_TMS\_SYNC\_TTO\_WIDTH
  - mc.c, 745
- MC\_TMS\_SYNC\_TWR\_OFFSET
  - mc.c, 745
- MC\_TMS\_SYNC\_TWR\_WIDTH
  - mc.c, 745
- MC\_TMS\_SYNC\_VALID
  - mc.c, 745
- MC\_TMS\_VALID
  - mc.c, 745
- mc\_write\_word
  - mc.c, 747
- mcr
  - dev\_16450, 74
- mcs
  - mc.c, 748
- mdelay
  - runtime, 165
- mdep
  - cuc\_bb, 63
- MEDIA\_EJECT
  - atacmd.h, 627
- MEDIA\_LOCK
  - atacmd.h, 627
- MEDIA\_UNLOCK
  - atacmd.h, 627
- mem
  - ata\_host, 26
  - ic, 127
  - mc\_area, 148
  - mem\_config, 150
- mem\_config
  - MT\_PATTERN, 149
  - MT\_RANDOM, 149
  - MT\_UNKNOWN, 149
- mem\_config, 149
  - baseaddr, 150
  - ce, 150
  - delayr, 150
  - delayw, 150
  - log, 150

- mc, 150
- mem, 150
- name, 150
- pattern, 150
- random\_seed, 150
- size, 150
- type, 150
- mem\_cycles
  - runtime, 165
- mem\_ops, 151
  - delayr, 152
  - delayw, 152
  - log, 152
  - read\_dat16, 152
  - read\_dat32, 152
  - read\_dat8, 152
  - readfunc16, 152
  - readfunc32, 152
  - readfunc8, 152
  - write\_dat16, 152
  - write\_dat32, 152
  - write\_dat8, 152
  - writfunc16, 152
  - writfunc32, 152
  - writfunc8, 152
  - writeprog32, 152
  - writeprog32\_dat, 152
  - writeprog8, 152
  - writeprog8\_dat, 152
- mem\_ordering\_cmp
  - cuc/memory.c, 500
- mem\_reset
  - peripheral/memory.c, 503
- memory.h
  - reg\_memory\_sec, 752
- memory\_baseaddr
  - peripheral/memory.c, 503
- memory\_ce
  - peripheral/memory.c, 503
- memory\_delay
  - timings.c, 509
- memory\_delayr
  - peripheral/memory.c, 503
- memory\_delayw
  - peripheral/memory.c, 503
- memory\_hash, 153
  - addr, 153
  - cnt, 153
  - next, 153
- MEMORY\_LEN
  - parse.c, 273
- memory\_log
  - peripheral/memory.c, 503
- memory\_mc
  - peripheral/memory.c, 503
- memory\_name
  - peripheral/memory.c, 503
- memory\_order
  - \_cuc\_func, 16
  - config, 55
- memory\_pattern
  - peripheral/memory.c, 503
- memory\_random\_seed
  - peripheral/memory.c, 503
- memory\_sec\_end
  - peripheral/memory.c, 504
- memory\_sec\_start
  - peripheral/memory.c, 504
- memory\_size
  - peripheral/memory.c, 504
- memory\_table\_status
  - abstract.c, 220
  - abstract.h, 237
- memory\_type
  - peripheral/memory.c, 504
- mfspir
  - sprs.c, 322
  - sprs.h, 323
- miiaddress
  - eth\_device, 113
- miicommand
  - eth\_device, 113
- miimoder
  - eth\_device, 113
- miirx\_data
  - eth\_device, 113
- miistatus
  - eth\_device, 113
- miitx\_data
  - eth\_device, 113
- MIN
  - 16450.c, 601
  - cuc.h, 469
  - or32.c, 432
- MIN\_DC\_BLOCK\_SIZE
  - dcache-model.h, 196
- MIN\_IC\_BLOCK\_SIZE
  - icache-model.c, 199
- MIN\_MWDMA\_CYCLE\_TIME
  - atadevice-cmdi.h, 636
- MIN\_PIO\_CYCLE\_TIME\_IORDY
  - atadevice-cmdi.h, 636
- MIN\_PIO\_CYCLE\_TIME\_NO\_IORDY
  - atadevice-cmdi.h, 636
- minimum\_length
  - eth\_device, 113
- misc.c
  - is\_power2, 830

- log2\_int, 830
- misc.h
  - is\_power2, 831
  - log2\_int, 831
- miss
  - bpbstat, 31
  - bticstat, 35
- missdelay
  - config, 55
  - dmmu, 86
  - ic, 127
  - immu, 129
- mmu/dmmu.c, 572
- mmu/dmmu.h, 578
- mmu/immu.c, 581
- mmu/immu.h, 586
- MO\_EXACT
  - cuc.h, 469
- MO\_NONE
  - cuc.h, 469
- MO\_STRONG
  - cuc.h, 469
- MO\_WEAK
  - cuc.h, 469
- MODE\_ACCESS
  - mprofiler.c, 590
- MODE\_DETAIL
  - mprofiler.c, 590
- MODE\_PRETTY
  - mprofiler.c, 590
- MODE\_WIDTH
  - mprofiler.c, 590
- moder
  - eth\_device, 113
- mp\_entry, 154
  - addr, 154
  - instr, 154
  - next, 154
  - type, 154
- mp\_hash
  - rsp-server.c, 559
- mp\_hash\_add
  - rsp-server.c, 544
- mp\_hash\_delete
  - rsp-server.c, 544
- mp\_hash\_init
  - rsp-server.c, 545
- mp\_hash\_lookup
  - rsp-server.c, 545
- MP\_HASH\_SIZE
  - rsp-server.c, 539
- mp\_type
  - rsp-server.c, 540
- MPROF\_16
  - profile.h, 834
- MPROF\_32
  - profile.h, 834
- MPROF\_8
  - profile.h, 834
- MPROF\_FETCH
  - profile.h, 834
- mprof\_fn
  - config, 55
- MPROF\_READ
  - profile.h, 834
- MPROF\_WRITE
  - profile.h, 834
- mprofentry\_struct, 155
  - addr, 155
  - type, 155
- mprofile
  - config, 55
  - profile.c, 832
  - profile.h, 834
- mprofiler.c, 589
  - BUF\_SIZE, 590
  - end\_addr, 591
  - fprof, 591
  - group\_bits, 591
  - hash, 591
  - hash\_add, 590
  - HASH\_FUNC, 590
  - hash\_get, 590
  - HASH\_SIZE, 590
  - init, 590
  - main\_mprofiler, 590
  - MODE\_ACCESS, 590
  - MODE\_DETAIL, 590
  - MODE\_PRETTY, 590
  - MODE\_WIDTH, 590
  - nbits, 591
  - printout, 591
  - read\_file, 591
  - start\_addr, 591
- mprofiler.h, 593
  - main\_mprofiler, 593
- msched
  - \_cuc\_func, 16
- msr
  - dev\_16450, 74
- mstats\_entry, 156
  - bf, 156
  - bnf, 156
  - bpb, 156
  - btic, 156
  - byteadd, 156
- MT\_PATTERN
  - mem\_config, 149

- MT\_RANDOM
  - mem\_config, 149
- MT\_UNKNOWN
  - mem\_config, 149
- MT\_BURST
  - cuc.h, 469
- MT\_BURSTE
  - cuc.h, 469
- MT\_CALL
  - cuc.h, 469
- MT\_LOAD
  - cuc.h, 469
- MT\_SIGNED
  - cuc.h, 469
- MT\_STORE
  - cuc.h, 469
- MT\_WIDTH
  - cuc.h, 469
- mtohl
  - generic.c, 729
- mtohs
  - generic.c, 729
- mtspr
  - sprs.c, 322
  - sprs.h, 324
- mtype
  - \_cuc\_func, 16
- multitissue
  - execute.c, 376
- mwdma
  - ata\_device, 22
- N\_CE
  - mc.c, 745
- n\_descsz
  - elf32\_note, 93
  - elf64\_note, 102
- n\_namesz
  - elf32\_note, 93
  - elf64\_note, 102
- n\_type
  - elf32\_note, 93
  - elf64\_note, 102
- name
  - channel\_factory, 38
  - config\_param, 58
  - config\_section, 59
  - cuc\_known\_insn, 66
  - dev\_generic, 77
  - func\_struct, 122
  - label\_entry, 145
  - mem\_config, 150
  - reloc, 161
  - sim\_command, 169
  - spr\_bit\_def, 172
  - spr\_def, 173
  - stack\_struct, 175
  - tty.c, 676
- namein
  - file\_channel, 120
- nameout
  - file\_channel, 120
- nbits
  - mprofiler.c, 591
- ncolours
  - INFOHEADER, 131
- negate\_conditional
  - cuc.h, 477
  - load.c, 497
- new\_bb\_cycles
  - timings.c, 509
- new\_dp
  - dyn-rec.c, 348
  - dyn-rec.h, 354
- new\_time
  - cuc\_timings, 69
- next
  - \_csm\_list, 14
  - \_dep\_list\_t, 17
  - breakpoint\_entry, 33
  - channel\_factory, 38
  - config\_param, 58
  - config\_section, 59
  - cuc\_bb, 63
  - dev\_memarea, 79
  - dma\_controller, 84
  - gpio\_device, 124
  - hist\_exec, 125
  - label\_entry, 145
  - mc, 147
  - mc\_area, 148
  - memory\_hash, 153
  - mp\_entry, 154
  - op\_queue, 158
  - sched\_entry, 167
  - sim\_reset\_hook, 170
  - sim\_stat, 171
  - vapi\_handler, 178
- next\_delay\_insn
  - execute.c, 376
- nfdeps
  - \_cuc\_func, 16
- nfds
  - vapi.c, 873
- nfuncalls
  - profiler.c, 782
- nhandlers
  - vapi.c, 873

- ninsn
  - \_csm\_list, 14
  - cuc\_bb, 63
- nmemory
  - cuc\_bb, 63
- nmsched
  - \_cuc\_func, 16
- no\_multicycle
  - config, 55
- nonblocking
  - tcp\_channel, 176
- NOP
  - atacmd.h, 627
- NOP\_CNT\_RESET
  - spr-defs.h, 307
- NOP\_EXIT
  - spr-defs.h, 307
- NOP\_NOP
  - spr-defs.h, 307
- NOP\_PRINTF
  - spr-defs.h, 307
- NOP\_PUTC
  - spr-defs.h, 307
- NOP\_REPORT
  - spr-defs.h, 307
- NOP\_REPORT\_FIRST
  - spr-defs.h, 307
- NOP\_REPORT\_LAST
  - spr-defs.h, 307
- not\_jump\_loc
  - op\_queue, 158
- nottaken
  - branchstat, 32
- npc\_not\_valid
  - cpu\_state, 61
- NPC\_REGNUM
  - rsp-server.c, 539
- nr\_sect
  - ata\_device, 22
- nsets
  - config, 55
  - dmmu, 86
  - ic, 127
  - immu, 129
- nshared
  - cuc\_timings, 69
- nstack
  - profiler.c, 782
- NT\_PRFPREG
  - elf.h, 260
- NT\_PRPSINFO
  - elf.h, 260
- NT\_PRSTATUS
  - elf.h, 260
- NT\_TASKSTRUCT
  - elf.h, 260
- ntim
  - cuc\_bb, 63
- ntotcalls
  - profiler.c, 782
- num\_bb
  - \_cuc\_func, 16
- num\_ids
  - vapi\_handler, 178
- num\_init\_bb
  - \_cuc\_func, 16
- num\_insn
  - cuc.h, 481
  - load.c, 498
- num\_ones
  - or32.c, 434
- num\_opcodes
  - or32.c, 435
- num\_ops
  - op\_queue, 158
- num\_ops\_param
  - op\_queue, 158
- NUM\_REGS
  - rsp-server.c, 540
- num\_regs
  - jtr\_read\_block\_message, 136
  - jtr\_read\_block\_response, 137
  - jtr\_write\_block\_message, 140
- num\_runs
  - \_cuc\_func, 16
- NUM\_T\_REGS
  - i386-regs.h, 380
- nuncovered
  - or32.c, 435
- nways
  - config, 55
  - dmmu, 86
  - ic, 127
  - immu, 129
- oe
  - gpio\_device, 124
- offset
  - BMP\_HEADER, 29
  - eth\_device, 113
- OP
  - op.c, 423
- op
  - cuc\_insn, 65
- op-1t-op.h
  - glue, 393
- op-1t.h
  - OP\_1T, 394



- T, 394
- op-2t-op.h
  - glue, 395
- op-2t.h
  - OP\_2T, 396
  - T, 396
- op-3t-op.h
  - glue, 397
- op-3t.h
  - OP\_3T, 398
  - T, 398
- op-extend-op.h
  - glue, 401
- op-ffl-op.h
  - glue, 402
- op-i386.h
  - asm, 403
  - FORCE\_RET, 403
  - OP\_JUMP, 403
  - SPEEDY\_CALL, 403
- op-mac-op.h
  - glue, 405
- op-mftspr-op.h
  - op\_mtspr\_imm\_clear, 406
- op-support.c
  - do\_jump, 408
  - op\_support\_analysis, 408
  - op\_support\_nop\_exit, 408
  - op\_support\_nop\_printf, 408
  - op\_support\_nop\_report, 408
  - op\_support\_nop\_report\_imm, 408
  - op\_support\_nop\_reset, 408
- op-support.h
  - do\_jump, 409
  - op\_support\_analysis, 409
  - op\_support\_nop\_exit, 409
  - op\_support\_nop\_printf, 410
  - op\_support\_nop\_report, 410
  - op\_support\_nop\_report\_imm, 410
  - op\_support\_nop\_reset, 410
  - upd\_reg\_from\_t, 410
- op-swhb-op.h
  - glue, 411
- op-t-reg-mov-op.h
  - glue, 415
- op.c
  - \_\_op\_param1, 429
  - \_\_op\_param2, 429
  - \_\_op\_param3, 429
  - \_\_or\_dynop, 423
  - asm, 423
  - COMP, 423
  - COMP\_CAST, 423
  - COMP\_NAME, 423
  - do\_sched\_wrap, 423
  - do\_sched\_wrap\_delay, 424
  - enter\_dyn\_code, 424
  - EXT\_CAST, 423
  - EXT\_NAME, 423
  - EXT\_TYPE, 423
  - LS\_OP\_CAST, 423
  - LS\_OP\_FUNC, 423
  - LS\_OP\_NAME, 423
  - OP, 423
  - op\_add\_pc, 424
  - op\_analysis, 424
  - OP\_CAST, 423
  - op\_check\_delay\_slot, 424
  - op\_check\_flag, 424
  - op\_check\_flag\_delay, 424
  - op\_check\_not\_flag, 425
  - op\_check\_not\_flag\_delay, 425
  - op\_clear\_delay\_insn, 425
  - op\_clear\_flag, 425
  - op\_clear\_pc\_delay, 425
  - op\_do\_jump\_delay, 425
  - op\_do\_sched, 425
  - op\_do\_sched\_delay, 425
  - OP\_EXTRA, 423
  - OP\_FILE, 423
  - op\_illegal, 425
  - op\_illegal\_delay, 427
  - op\_jump\_imm, 427
  - op\_join\_mem\_cycles, 427
  - op\_macc, 427
  - op\_move\_gpr10\_pc\_delay, 427
  - op\_move\_gpr11\_pc\_delay, 427
  - op\_move\_gpr12\_pc\_delay, 427
  - op\_move\_gpr13\_pc\_delay, 427
  - op\_move\_gpr14\_pc\_delay, 427
  - op\_move\_gpr15\_pc\_delay, 427
  - op\_move\_gpr16\_pc\_delay, 427
  - op\_move\_gpr17\_pc\_delay, 427
  - op\_move\_gpr18\_pc\_delay, 427
  - op\_move\_gpr19\_pc\_delay, 427
  - op\_move\_gpr1\_pc\_delay, 427
  - op\_move\_gpr20\_pc\_delay, 427
  - op\_move\_gpr21\_pc\_delay, 427
  - op\_move\_gpr22\_pc\_delay, 427
  - op\_move\_gpr23\_pc\_delay, 427
  - op\_move\_gpr24\_pc\_delay, 427
  - op\_move\_gpr25\_pc\_delay, 427
  - op\_move\_gpr26\_pc\_delay, 427
  - op\_move\_gpr27\_pc\_delay, 427
  - op\_move\_gpr28\_pc\_delay, 427
  - op\_move\_gpr29\_pc\_delay, 427
  - op\_move\_gpr2\_pc\_delay, 427
  - op\_move\_gpr30\_pc\_delay, 427

- op\_move\_gpr31\_pc\_delay, 427
- op\_move\_gpr3\_pc\_delay, 427
- op\_move\_gpr4\_pc\_delay, 427
- op\_move\_gpr5\_pc\_delay, 427
- op\_move\_gpr6\_pc\_delay, 427
- op\_move\_gpr7\_pc\_delay, 427
- op\_move\_gpr8\_pc\_delay, 427
- op\_move\_gpr9\_pc\_delay, 427
- OP\_NAME, 423
- op\_nop\_exit, 427
- op\_nop\_printf, 428
- op\_nop\_report, 428
- op\_nop\_report\_imm, 428
- op\_nop\_reset, 428
- OP\_PARAM1, 423
- OP\_PARAM2, 423
- OP\_PARAM3, 423
- op\_prep\_rfe, 428
- op\_prep\_sys, 428
- op\_prep\_sys\_delay, 428
- op\_prep\_trap, 429
- op\_prep\_trap\_delay, 429
- op\_set\_delay\_insn, 429
- op\_set\_flag, 429
- op\_set\_pc\_delay\_imm, 429
- op\_set\_pc\_delay\_pc, 429
- op\_set\_pc\_pc\_delay, 429
- op\_store\_insn\_ea, 429
- op\_store\_link\_addr\_gpr, 429
- prep\_except, 429
- S\_FUNC, 423
- S\_OP\_NAME, 423
- save\_t\_bound, 429
- OP\_1T
  - op-1t.h, 394
- OP\_2T
  - op-2t.h, 396
- OP\_3T
  - op-3t.h, 398
- op\_add\_pc
  - op.c, 424
- op\_analysis
  - op.c, 424
- OP\_CAST
  - op.c, 423
- op\_check\_delay\_slot
  - op.c, 424
- op\_check\_flag
  - op.c, 424
- op\_check\_flag\_delay
  - op.c, 424
- op\_check\_not\_flag
  - op.c, 425
- op\_check\_not\_flag\_delay
  - op.c, 425
- op\_clear\_delay\_insn
  - op.c, 425
- op\_clear\_flag
  - op.c, 425
- op\_clear\_pc\_delay
  - op.c, 425
- op\_data
  - or32.c, 435
- op\_do\_jump\_delay
  - op.c, 425
- op\_do\_sched
  - op.c, 425
- op\_do\_sched\_delay
  - op.c, 425
- OP\_EXTRA
  - op.c, 423
- OP\_FILE
  - op.c, 423
- OP\_FUNC\_PARAM\_PREFIX
  - dyngen.c, 363
- OP\_FUNC\_PREFIX
  - dyngen.c, 363
- op\_illegal
  - op.c, 425
- op\_illegal\_delay
  - op.c, 427
- op\_jmp\_imm
  - op.c, 427
- op\_join\_mem\_cycles
  - except.c, 293
  - op.c, 427
- OP\_JUMP
  - op-i386.h, 403
- op\_macc
  - op.c, 427
- OP\_MEM\_ACCESS
  - abstract.h, 231
- op\_move\_gpr10\_pc\_delay
  - op.c, 427
- op\_move\_gpr11\_pc\_delay
  - op.c, 427
- op\_move\_gpr12\_pc\_delay
  - op.c, 427
- op\_move\_gpr13\_pc\_delay
  - op.c, 427
- op\_move\_gpr14\_pc\_delay
  - op.c, 427
- op\_move\_gpr15\_pc\_delay
  - op.c, 427
- op\_move\_gpr16\_pc\_delay
  - op.c, 427
- op\_move\_gpr17\_pc\_delay
  - op.c, 427

- op\_move\_gpr18\_pc\_delay
  - op.c, 427
- op\_move\_gpr19\_pc\_delay
  - op.c, 427
- op\_move\_gpr1\_pc\_delay
  - op.c, 427
- op\_move\_gpr20\_pc\_delay
  - op.c, 427
- op\_move\_gpr21\_pc\_delay
  - op.c, 427
- op\_move\_gpr22\_pc\_delay
  - op.c, 427
- op\_move\_gpr23\_pc\_delay
  - op.c, 427
- op\_move\_gpr24\_pc\_delay
  - op.c, 427
- op\_move\_gpr25\_pc\_delay
  - op.c, 427
- op\_move\_gpr26\_pc\_delay
  - op.c, 427
- op\_move\_gpr27\_pc\_delay
  - op.c, 427
- op\_move\_gpr28\_pc\_delay
  - op.c, 427
- op\_move\_gpr29\_pc\_delay
  - op.c, 427
- op\_move\_gpr2\_pc\_delay
  - op.c, 427
- op\_move\_gpr30\_pc\_delay
  - op.c, 427
- op\_move\_gpr31\_pc\_delay
  - op.c, 427
- op\_move\_gpr3\_pc\_delay
  - op.c, 427
- op\_move\_gpr4\_pc\_delay
  - op.c, 427
- op\_move\_gpr5\_pc\_delay
  - op.c, 427
- op\_move\_gpr6\_pc\_delay
  - op.c, 427
- op\_move\_gpr7\_pc\_delay
  - op.c, 427
- op\_move\_gpr8\_pc\_delay
  - op.c, 427
- op\_move\_gpr9\_pc\_delay
  - op.c, 427
- op\_mtspr\_imm\_clear
  - op-mftspr-op.h, 406
- OP\_NAME
  - op.c, 423
- op\_nop\_exit
  - op.c, 427
- op\_nop\_printf
  - op.c, 428
- op\_nop\_report
  - op.c, 428
- op\_nop\_report\_imm
  - op.c, 428
- op\_nop\_reset
  - op.c, 428
- OP\_PARAM1
  - op.c, 423
- OP\_PARAM2
  - op.c, 423
- OP\_PARAM3
  - op.c, 423
- op\_prep\_rfe
  - op.c, 428
- op\_prep\_sys
  - op.c, 428
- op\_prep\_sys\_delay
  - op.c, 428
- op\_prep\_trap
  - op.c, 429
- op\_prep\_trap\_delay
  - op.c, 429
- op\_queue, 157
  - insn, 158
  - insn\_addr, 158
  - insn\_index, 158
  - jump\_local, 158
  - jump\_local\_loc, 158
  - next, 158
  - not\_jump\_loc, 158
  - num\_ops, 158
  - num\_ops\_param, 158
  - ops, 158
  - ops\_len, 158
  - ops\_param, 158
  - ops\_param\_len, 158
  - param, 158
  - param\_num, 158
  - param\_type, 158
  - prev, 158
  - reg\_t, 158
  - tflags, 158
  - xref, 158
- op\_set\_delay\_insn
  - op.c, 429
- op\_set\_flag
  - op.c, 429
- op\_set\_pc\_delay\_imm
  - op.c, 429
- op\_set\_pc\_delay\_pc
  - op.c, 429
- op\_set\_pc\_pc\_delay
  - op.c, 429
- op\_start

- or32.c, 435
- op\_store\_insn\_ea
  - op.c, 429
- op\_store\_link\_addr\_gpr
  - op.c, 429
- op\_support\_analysis
  - op-support.c, 408
  - op-support.h, 409
- op\_support\_nop\_exit
  - op-support.c, 408
  - op-support.h, 409
- op\_support\_nop\_printf
  - op-support.c, 408
  - op-support.h, 410
- op\_support\_nop\_report
  - op-support.c, 408
  - op-support.h, 410
- op\_support\_nop\_report\_imm
  - op-support.c, 408
  - op-support.h, 410
- op\_support\_nop\_reset
  - op-support.c, 408
  - op-support.h, 410
- open
  - channel\_ops, 39
- open\_file
  - atadevice.c, 640
- open\_local
  - atadevice.c, 641
- open\_obj
  - bff, 28
- OPERANDNAME\_LEN
  - abstract.h, 231
- ops
  - channel, 37
  - channel\_factory, 38
  - dev\_memarea, 79
  - op\_queue, 158
- OPS\_ENLARGE\_BY
  - dyn-rec.c, 335
- ops\_len
  - op\_queue, 158
- ops\_param
  - op\_queue, 158
- ops\_param\_len
  - op\_queue, 158
- opt
  - cuc\_insn, 65
- OPT\_BB
  - cuc.h, 469
- OPT\_CONST
  - cuc.h, 469
- OPT\_DEST
  - cuc.h, 469
- OPT\_JUMP
  - cuc.h, 469
- OPT\_LRBB
  - cuc.h, 469
- OPT\_NONE
  - cuc.h, 469
- OPT\_REF
  - cuc.h, 469
- OPT\_REGISTER
  - cuc.h, 469
- optimize\_bb
  - bb.c, 445
  - cuc.h, 477
- optimize\_cmov\_more
  - insn.c, 485
- optimize\_cmovs
  - cuc.h, 477
  - insn.c, 485
- optimize\_tree
  - cuc.h, 477
  - insn.c, 485
- option\_char
  - cuc.c, 463
- options\_cmd
  - cuc.c, 459
- OR1K\_JTAG\_COMMAND\_CHAIN
  - gdb.h, 530
- OR1K\_JTAG\_COMMAND\_READ
  - gdb.h, 530
- OR1K\_JTAG\_COMMAND\_READ\_BLOCK
  - gdb.h, 530
- OR1K\_JTAG\_COMMAND\_WRITE
  - gdb.h, 530
- OR1K\_JTAG\_COMMAND\_WRITE\_BLOCK
  - gdb.h, 530
- or1k\_jtag\_errors
  - gdb.h, 529
- or1k\_jtag\_proxy\_protocol\_commands
  - gdb.h, 530
- OR1K\_MEM\_VERILOG\_FOOTER
  - dumpverilog.c, 826
- OR1K\_MEM\_VERILOG\_HEADER
  - dumpverilog.c, 826
- or1k\_mstats
  - stats.c, 282
  - stats.h, 285
- OR1K\_TRAP\_INSTR
  - rsp-server.c, 540
- or1ksim.h, 594
  - OR1KSIM\_RC\_BADINIT, 594
  - OR1KSIM\_RC\_BRKPT, 594
  - OR1KSIM\_RC\_OK, 594
  - or1ksim\_clock\_rate, 594
  - or1ksim\_get\_time\_period, 594

- orlksim\_init, 595
- orlksim\_interrupt, 595
- orlksim\_interrupt\_clear, 595
- orlksim\_interrupt\_set, 595
- orlksim\_is\_le, 596
- orlksim\_rc, 594
- orlksim\_reset\_duration, 596
- orlksim\_run, 596
- orlksim\_set\_time\_point, 597
- OR1KSIM\_RC\_BADINIT
  - orlksim.h, 594
- OR1KSIM\_RC\_BRKPT
  - orlksim.h, 594
- OR1KSIM\_RC\_OK
  - orlksim.h, 594
- orlksim\_clock\_rate
  - libtoplevel.c, 565
  - orlksim.h, 594
- orlksim\_get\_time\_period
  - libtoplevel.c, 565
  - orlksim.h, 594
- orlksim\_init
  - libtoplevel.c, 565
  - orlksim.h, 595
- orlksim\_interrupt
  - libtoplevel.c, 568
  - orlksim.h, 595
- orlksim\_interrupt\_clear
  - libtoplevel.c, 568
  - orlksim.h, 595
- orlksim\_interrupt\_set
  - libtoplevel.c, 568
  - orlksim.h, 595
- orlksim\_is\_le
  - libtoplevel.c, 568
  - orlksim.h, 596
- orlksim\_rc
  - orlksim.h, 594
- orlksim\_reset\_duration
  - libtoplevel.c, 568
  - orlksim.h, 596
- OR1KSIM\_RSP\_PROTOCOL
  - rsp-server.c, 540
- OR1KSIM\_RSP\_SERVICE
  - rsp-server.c, 540
- orlksim\_run
  - libtoplevel.c, 569
  - orlksim.h, 596
- orlksim\_set\_time\_point
  - libtoplevel.c, 569
  - orlksim.h, 597
- OR1KSIM\_TID
  - rsp-server.c, 540
- or32.c
  - automata, 435
  - build\_automata, 432
  - cover\_insn, 432
  - curpass, 435
  - destruct\_automata, 432
  - disassemble\_index, 433
  - disassemble\_insn, 433
  - disassembled, 435
  - disassembled\_str, 435
  - EF, 432
  - EFI, 432
  - EFN, 432
  - extend\_imm, 433
  - insn\_decode, 433
  - insn\_extract, 434
  - insn\_index, 434
  - insn\_len, 434
  - insn\_name, 434
  - l\_none, 434
  - letter\_range, 434
  - letter\_signed, 434
  - MAX\_AUTOMATA\_SIZE, 432
  - MAX\_LEN, 432
  - MAX\_OP\_TABLE\_SIZE, 432
  - MIN, 432
  - num\_ones, 434
  - num\_opcodes, 435
  - nuncovered, 435
  - op\_data, 435
  - op\_start, 435
  - or32\_debug, 434
  - or32\_extract, 434
  - or32\_letters, 435
  - or32\_opcodes, 435
  - or32\_print\_immediate, 434
  - or32\_print\_register, 434
  - parse\_params, 434
  - range\_cache, 436
  - ti, 436
- or32\_debug
  - or32.c, 434
- or32\_extract
  - or32.c, 434
- or32\_letters
  - or32.c, 435
- or32\_opcodes
  - or32.c, 435
- or32\_print\_immediate
  - or32.c, 434
- or32\_print\_register
  - or32.c, 434
- or\_page
  - dyn\_page, 89
- oraddr\_t

- arch.h, 291
- orig\_time
  - \_cuc\_func, 16
- orreg\_t
  - arch.h, 291
- orsim\_dbcl\_set
  - debug.c, 820
- orsim\_dbcl\_set\_name
  - debug.c, 820
  - debug.h, 823
- orsim\_dbg\_log
  - debug.c, 820
  - debug.h, 824
- osize
  - \_csm\_list, 14
- out
  - gpio\_device, 124
- out\_file
  - generate.c, 379
- out\_lines
  - generate.c, 379
- output\_call
  - generate.c, 378
- output\_function
  - generate.c, 379
- output\_verilog
  - verilog.c, 511
  - verilog.h, 513
- p\_align
  - elf32\_phdr, 94
  - elf64\_phdr, 103
- p\_filesz
  - elf32\_phdr, 94
  - elf64\_phdr, 103
- p\_flags
  - elf32\_phdr, 94
  - elf64\_phdr, 103
- p\_memsz
  - elf32\_phdr, 94
  - elf64\_phdr, 103
- p\_offset
  - elf32\_phdr, 94
  - elf64\_phdr, 103
- p\_paddr
  - elf32\_phdr, 94
  - elf64\_phdr, 103
- p\_type
  - elf32\_phdr, 94
  - elf64\_phdr, 103
- p\_vaddr
  - elf32\_phdr, 94
  - elf64\_phdr, 103
- PACKET
  - atacmd.h, 627
- packet
  - ata\_device, 22
- packet\_length
  - eth\_device, 113
- packetlen
  - eth\_device, 113
- page\_mask
  - dmmu, 86
  - immu, 129
- page\_offset\_mask
  - dmmu, 86
  - immu, 129
- pagesize
  - dmmu, 86
  - immu, 129
- pagesize\_log2
  - dmmu, 86
  - immu, 129
- pal
  - fb\_state, 118
- palette
  - vga\_state, 180
- param
  - op\_queue, 158
  - sched\_entry, 167
- param\_num
  - op\_queue, 158
- param\_t
  - sim-config.h, 813
- param\_type
  - op\_queue, 158
- param\_val, 159
  - addr\_val, 159
  - int\_val, 159
  - longlong\_val, 159
  - str\_val, 159
- PARAMS
  - dyn32-defs.h, 357
  - simpl32-defs.h, 439
- params
  - config\_section, 59
- paramt\_addr
  - sim-config.h, 813
- paramt\_int
  - sim-config.h, 813
- paramt\_longlong
  - sim-config.h, 813
- paramt\_none
  - sim-config.h, 813
- paramt\_str
  - sim-config.h, 813
- paramt\_word
  - sim-config.h, 813

- parse.c
  - addprogram, 273
  - freemem, 277
  - identifyfile, 273
  - IMM\_STATS, 273
  - loadcode, 274
  - MEMORY\_LEN, 273
  - readfile\_coff, 275
  - readfile\_elf, 275
  - readsyms\_coff, 276
  - rstrip, 276
  - transl\_error, 277
  - transl\_table, 277
  - translate, 276
- parse.h
  - loadcode, 278
  - rstrip, 279
- parse\_args
  - sim-config.c, 805
  - sim-config.h, 814
- parse\_baud
  - tty.c, 676
- parse\_dbchs
  - debug.c, 820
  - debug.h, 824
- parse\_params
  - or32.c, 434
- pattern
  - mem\_config, 150
- pc
  - cpu\_state, 61
- pc\_delay
  - cpu\_state, 61
- pcnext
  - execute.c, 376
  - execute.h, 267
- pctr
  - ata\_host, 26
- pdiagi
  - ata\_device, 22
- pdiago
  - ata\_device, 22
- peek\_into\_dtlb
  - dmmu.c, 576
  - dmmu.h, 579
- peek\_into\_itlb
  - immu.c, 585
  - immu.h, 587
- peripheral/16450.c, 598
- peripheral/16450.h, 620
- peripheral/atacmd.h, 624
- peripheral/atadevice-cmdi.c, 628
- peripheral/atadevice-cmdi.h, 633
- peripheral/atadevice.c, 638
- peripheral/atadevice.h, 642
- peripheral/atahost.c, 647
- peripheral/atahost.h, 657
- peripheral/channels/channel.c, 663
- peripheral/channels/channel.h, 665
- peripheral/channels/fd.c, 666
- peripheral/channels/fd.h, 668
- peripheral/channels/file.c, 669
- peripheral/channels/file.h, 671
- peripheral/channels/generic.c, 730
- peripheral/channels/generic.h, 732
- peripheral/channels/tcp.c, 672
- peripheral/channels/tcp.h, 674
- peripheral/channels/tty.c, 675
- peripheral/channels/tty.h, 677
- peripheral/channels/xterm.c, 678
- peripheral/channels/xterm.h, 680
- peripheral/crc32.c, 681
- peripheral/crc32.h, 682
- peripheral/dma-defs.h, 683
- peripheral/dma.c, 690
- peripheral/dma.h, 697
- peripheral/eth.c, 699
- peripheral/eth.h, 714
- peripheral/fb.c, 716
- peripheral/fb.h, 722
- peripheral/fields.h, 723
- peripheral/generic.c, 725
- peripheral/generic.h, 731
- peripheral/gpio.c, 733
- peripheral/gpio.h, 740
- peripheral/mc.c, 741
- peripheral/mc.h, 749
- peripheral/memory.c, 502
  - mem\_reset, 503
  - memory\_baseaddr, 503
  - memory\_ce, 503
  - memory\_delayr, 503
  - memory\_delayw, 503
  - memory\_log, 503
  - memory\_mc, 503
  - memory\_name, 503
  - memory\_pattern, 503
  - memory\_random\_seed, 503
  - memory\_sec\_end, 504
  - memory\_sec\_start, 504
  - memory\_size, 504
  - memory\_type, 504
  - reg\_memory\_sec, 505
  - simmem\_read16, 505
  - simmem\_read32, 506
  - simmem\_read8, 506
  - simmem\_read\_zero16, 506
  - simmem\_read\_zero32, 506

- simmem\_read\_zero8, 506
  - simmem\_write16, 506
  - simmem\_write32, 506
  - simmem\_write8, 506
  - simmem\_write\_null16, 506
  - simmem\_write\_null32, 506
  - simmem\_write\_null8, 506
- peripheral/memory.h, 751
- peripheral/ps2kbd.c, 753
- peripheral/ps2kbd.h, 760
- peripheral/vga.c, 761
- peripheral/vga.h, 767
- PF\_R
  - elf.h, 260
- PF\_W
  - elf.h, 260
- PF\_X
  - elf.h, 260
- pftr0
  - ata\_host, 26
- pftr1
  - ata\_host, 26
- pic
  - config, 55
  - fb\_state, 118
- pic.c
  - clear\_interrupt, 769
  - pic\_edge\_trigger, 769
  - pic\_enabled, 769
  - pic\_ints\_en, 769
  - pic\_rep\_int, 769
  - pic\_reset, 770
  - pic\_state, 771
  - pic\_state\_int, 771
  - reg\_pic\_sec, 770
  - report\_interrupt, 770
- pic.h
  - clear\_interrupt, 772
  - pic\_ints\_en, 772
  - pic\_reset, 772
  - reg\_pic\_sec, 772
  - report\_interrupt, 773
- pic/pic.c, 768
- pic/pic.h, 772
- pic\_edge\_trigger
  - pic.c, 769
- pic\_enabled
  - pic.c, 769
- pic\_ints\_en
  - pic.c, 769
  - pic.h, 772
- pic\_lines
  - cpu\_state, 61
- pic\_rep\_int
  - pic.c, 769
- pic\_reset
  - pic.c, 770
  - pic.h, 772
- pic\_state
  - pic.c, 771
- pic\_state\_int
  - pic.c, 771
- pics
  - vga\_state, 180
- pid
  - xterm\_channel, 181
- pindex
  - vga\_state, 180
- pio
  - ata\_device, 22
- pio\_mode
  - ata\_device, 22
- PIO\_MODE0\_T1
  - atahost.c, 649
- pio\_mode0\_t1
  - ata\_host, 26
- PIO\_MODE0\_T2
  - atahost.c, 649
- pio\_mode0\_t2
  - ata\_host, 26
- PIO\_MODE0\_T4
  - atahost.c, 649
- pio\_mode0\_t4
  - ata\_host, 26
- PIO\_MODE0\_TEOC
  - atahost.c, 649
- pio\_mode0\_teoc
  - ata\_host, 26
- planes
  - INFOHEADER, 131
- pm
  - config, 55
- pm.c
  - pm\_enabled, 774
  - pm\_reset, 774
  - reg\_pm\_sec, 774
- pm.h
  - pm\_reset, 776
  - reg\_pm\_sec, 776
- pm/pm.c, 774
- pm/pm.h, 776
- pm\_enabled
  - pm.c, 774
- pm\_reset
  - pm.c, 774
  - pm.h, 776
- poc
  - mc, 147



- port.h
  - isblank, 778
  - PRIx16, 778
  - PRIx8, 778
  - strndup, 778
- port/isblank.c, 777
- port/port.h, 778
- port/strndup.c, 779
- port\_number
  - tcp\_channel, 176
- POWERUP\_IN\_STANDBY\_FEATURE\_SET\_-  
SPINUP
  - atacmd.h, 627
- PPC\_REGNUM
  - rsp-server.c, 540
- preloaded
  - channel.c, 664
- prep\_except
  - op.c, 429
- preroll
  - cuc\_timings, 69
- preunroll\_bb
  - cuc.c, 459
- preunroll\_loop
  - bb.c, 445
  - cuc.h, 478
- prev
  - cuc\_bb, 63
  - hist\_exec, 125
  - op\_queue, 158
- PRIIdREG
  - arch.h, 290
- print\_bb\_num
  - bb.c, 445
  - cuc.h, 478
- print\_breakpoints
  - labels.c, 269
  - labels.h, 271
- print\_config
  - sim-config.c, 805
  - sim-config.h, 814
- print\_cuc\_bb
  - bb.c, 446
  - cuc.h, 478
- print\_cuc\_insns
  - cuc.h, 478
  - load.c, 497
- print\_deps
  - verilog.c, 511
- print\_insn\_exec
  - sim-cmd.c, 789
- print\_insn\_v
  - verilog.c, 512
- print\_insns
  - cuc.h, 479
  - insn.c, 486
- print\_op\_v
  - verilog.c, 512
- print\_option
  - cuc.c, 462
- print\_shared
  - insn.c, 486
  - insn.h, 492
- print\_turn\_off\_dep
  - verilog.c, 512
- PRINTF
  - sim-config.h, 813
- printhstats
  - stats.c, 281
- printout
  - mprofiler.c, 591
- printstats
  - stats.c, 281
  - stats.h, 285
- priv\_dat
  - vapi\_handler, 178
- PRIx16
  - port.h, 778
- PRIx8
  - port.h, 778
- PRIxADDR
  - arch.h, 290
- PRIxREG
  - arch.h, 291
- prof\_acquire
  - profiler.c, 781
  - profiler.h, 785
- prof\_cycles
  - profiler.c, 782
  - profiler.h, 785
- prof\_fn
  - config, 55
- prof\_func
  - profiler.c, 782
  - profiler.h, 785
- prof\_nfuncs
  - profiler.c, 782
  - profiler.h, 785
- prof\_print
  - profiler.c, 781
- prof\_set
  - profiler.c, 782
  - profiler.h, 785
- profile
  - config, 55
- profile.c
  - mprofile, 832
- profile.h

- MPROF\_16, 834
- MPROF\_32, 834
- MPROF\_8, 834
- MPROF\_FETCH, 834
- MPROF\_READ, 834
- MPROF\_WRITE, 834
- mprofile, 834
- profiler.c, 780
  - cumulative, 782
  - fprof, 782
  - main\_profiler, 781
  - MAX\_STACK, 781
  - maxstack, 782
  - nfuncalls, 782
  - nstack, 782
  - ntotcalls, 782
  - prof\_acquire, 781
  - prof\_cycles, 782
  - prof\_func, 782
  - prof\_nfuncs, 782
  - prof\_print, 781
  - prof\_set, 782
  - quiet, 782
  - stack, 782
- profiler.h, 784
  - main\_profiler, 784
  - MAX\_FUNCS, 784
  - prof\_acquire, 785
  - prof\_cycles, 785
  - prof\_func, 785
  - prof\_nfuncs, 785
  - prof\_set, 785
- proto\_num
  - rsp-server.c, 559
- protocol\_clean
  - gdbcomm.c, 534
- ps2kbd.c
  - code, 759
  - kbd\_baseaddr, 756
  - KBD\_BAUD\_RATE, 756
  - KBD\_CCMD\_DKI, 756
  - KBD\_CCMD\_EKI, 756
  - KBD\_CCMD\_RCB, 756
  - KBD\_CCMD\_ST1, 756
  - KBD\_CCMD\_ST2, 756
  - KBD\_CCMD\_WCB, 756
  - KBD\_CCMDBYTE\_EN, 756
  - KBD\_CCMDBYTE\_EN2, 756
  - KBD\_CCMDBYTE\_INT, 756
  - KBD\_CCMDBYTE\_INT2, 756
  - KBD\_CCMDBYTE\_SYS, 756
  - KBD\_CCMDBYTE\_XLAT, 756
  - KBD\_CTRL, 756
  - KBD\_DATA, 756
  - kbd\_enabled, 756
  - kbd\_info, 756
  - kbd\_irq, 756
  - kbd\_job, 756
  - KBD\_KCMD\_DK, 756
  - KBD\_KCMD\_ECHO, 756
  - KBD\_KCMD\_EK, 756
  - KBD\_KCMD\_RST, 756
  - KBD\_KCMD\_SRL, 756
  - KBD\_KRESP\_ACK, 756
  - KBD\_KRESP\_ECHO, 756
  - KBD\_KRESP\_RSTOK, 756
  - KBD\_MAX\_BUF, 756
  - kbd\_put, 757
  - kbd\_read8, 757
  - kbd\_reset, 757
  - kbd\_rxfile, 757
  - kbd\_sec\_end, 757
  - kbd\_sec\_start, 758
  - KBD\_SPACE, 756
  - KBD\_STATUS\_A2, 756
  - KBD\_STATUS\_IBF, 756
  - KBD\_STATUS\_INH, 756
  - KBD\_STATUS\_MOBF, 756
  - KBD\_STATUS\_OBF, 756
  - KBD\_STATUS\_PERR, 756
  - KBD\_STATUS\_SYS, 756
  - KBD\_STATUS\_TO, 756
  - kbd\_write8, 758
  - reg\_kbd\_sec, 758
  - scan\_decode, 759
  - scan\_table, 759
  - shift, 759
- ps2kbd.h
  - reg\_kbd\_sec, 760
- PT\_DYNAMIC
  - elf.h, 260
- PT\_HIPROC
  - elf.h, 260
- PT\_INTERP
  - elf.h, 260
- PT\_LOAD
  - elf.h, 260
- PT\_LOPROC
  - elf.h, 260
- PT\_NOTE
  - elf.h, 260
- PT\_NULL
  - elf.h, 260
- PT\_PHDR
  - elf.h, 260
- PT\_SHLIB
  - elf.h, 260
- ptring

- gpio\_device, 124
- put\_packet
  - rsp-server.c, 545
- put\_rsp\_char
  - rsp-server.c, 546
- put\_str\_packet
  - rsp-server.c, 546
- QUEUE\_DEPTH
  - atadevice-cmdi.h, 636
- quiet
  - profiler.c, 782
- R\_386\_32
  - elf.h, 260
- R\_386\_COPY
  - elf.h, 260
- R\_386\_GLOB\_DAT
  - elf.h, 260
- R\_386\_GOT32
  - elf.h, 260
- R\_386\_GOTOFF
  - elf.h, 260
- R\_386\_GOTPC
  - elf.h, 260
- R\_386\_JMP\_SLOT
  - elf.h, 260
- R\_386\_NONE
  - elf.h, 260
- R\_386\_NUM
  - elf.h, 260
- R\_386\_PC32
  - elf.h, 260
- R\_386\_PLT32
  - elf.h, 260
- R\_386\_RELATIVE
  - elf.h, 260
- R\_68K\_16
  - elf.h, 260
- R\_68K\_32
  - elf.h, 260
- R\_68K\_8
  - elf.h, 260
- R\_68K\_COPY
  - elf.h, 260
- R\_68K\_GLOB\_DAT
  - elf.h, 260
- R\_68K\_GOT16
  - elf.h, 260
- R\_68K\_GOT16O
  - elf.h, 260
- R\_68K\_GOT32
  - elf.h, 260
- R\_68K\_GOT32O
  - elf.h, 260
- R\_68K\_GOT8
  - elf.h, 260
- R\_68K\_GOT8O
  - elf.h, 260
- R\_68K\_JMP\_SLOT
  - elf.h, 260
- R\_68K\_NONE
  - elf.h, 260
- R\_68K\_PC16
  - elf.h, 260
- R\_68K\_PC32
  - elf.h, 260
- R\_68K\_PC8
  - elf.h, 260
- R\_68K\_PLT16
  - elf.h, 260
- R\_68K\_PLT16O
  - elf.h, 260
- R\_68K\_PLT32
  - elf.h, 260
- R\_68K\_PLT32O
  - elf.h, 260
- R\_68K\_PLT8
  - elf.h, 260
- R\_68K\_PLT8O
  - elf.h, 260
- R\_68K\_RELATIVE
  - elf.h, 260
- r\_addend
  - elf32\_rela, 96
  - elf64\_rela, 105
- r\_info
  - elf32\_rel, 95
  - elf32\_rela, 96
  - elf64\_rel, 104
  - elf64\_rela, 105
- r\_offset
  - elf32\_rel, 95
  - elf32\_rela, 96
  - elf64\_rel, 104
  - elf64\_rela, 105
- r\_symndx
  - COFF\_reloc, 47
- r\_type
  - COFF\_reloc, 47
- r\_vaddr
  - COFF\_reloc, 47
- raddr
  - stack\_struct, 175
- random\_seed
  - mem\_config, 150
- range
  - raw\_stats, 160

- range\_cache
  - or32.c, 436
- RAW\_RANGE
  - stats.h, 285
- raw\_stats, 160
  - range, 160
  - reg, 160
  - stats.c, 283
  - stats.h, 285
- read
  - channel\_ops, 39
- READ\_BUFFER
  - atacmd.h, 627
- read\_dat16
  - mem\_ops, 152
- read\_dat32
  - mem\_ops, 152
- read\_dat8
  - mem\_ops, 152
- READ\_DMA
  - atacmd.h, 627
- READ\_DMA\_QUEUED
  - atacmd.h, 627
- read\_file
  - mprofiler.c, 591
- read\_func
  - vapi\_handler, 178
- READ\_MULTIPLE
  - atacmd.h, 627
- READ\_NATIVE\_MAX\_ADDRESS
  - atacmd.h, 627
- read\_packet
  - vapi.c, 870
- read\_script\_file
  - sim-config.c, 806
- READ\_SECTOR
  - atacmd.h, 627
- READ\_SECTORS
  - atacmd.h, 627
- read\_up
  - config, 55
- READ\_VERIFY\_SECTOR
  - atacmd.h, 627
- READ\_VERIFY\_SECTORS
  - atacmd.h, 627
- readfile\_coff
  - parse.c, 275
- readfile\_elf
  - parse.c, 275
- readfunc16
  - mem\_ops, 152
- readfunc32
  - mem\_ops, 152
- readfunc8
  - mem\_ops, 152
- readhit
  - cachestats\_entry, 36
- readmiss
  - cachestats\_entry, 36
- readsyms\_coff
  - parse.c, 276
- rebuild\_fds
  - vapi.c, 870
- rec-i386.h
  - get\_sp, 437
- rec\_stack\_base
  - dyn-rec.h, 356
- recalc\_cnts
  - cuc.h, 479
  - timings.c, 509
- recalc\_last\_used\_reg
  - bb.c, 446
- RECED\_PAGE\_ENLARGE\_BY
  - dyn-rec.c, 335
- receiveing
  - dev\_16450, 74
- recheck\_immu
  - dyn-rec.c, 348
  - dyn-rec.h, 355
- RECOMMENDED\_MWDMA\_CYCLE\_TIME
  - atadevice-cmdi.h, 636
- recompile\_delay\_insn
  - dyn-rec.c, 348
- recompile\_insn
  - dyn-rec.c, 349
- recompile\_page
  - dyn-rec.c, 349
  - dyn-rec.h, 355
- recv\_break
  - dev\_16450, 74
- reenter\_int
  - sim-cmd.c, 790
- REF
  - cuc.h, 469
- ref
  - \_csm\_list, 14
  - \_dep\_list\_t, 17
  - cuc\_shared\_item, 67
- REF\_BB
  - cuc.h, 469
- REF\_I
  - cuc.h, 469
- referenced
  - dma\_channel, 81
- refresh
  - fb\_state, 118
- refresh\_count
  - fb\_state, 118

- REFRESH\_DIVIDER
  - fb.c, 717
- refresh\_rate
  - fb\_state, 118
  - vga\_state, 180
- reg
  - cpu\_state, 61
  - raw\_stats, 160
- reg2hex
  - rsp-server.c, 546
- reg\_ata\_sec
  - atahost.c, 653
  - atahost.h, 661
- reg\_bpb\_sec
  - branch-predict.c, 186
  - branch-predict.h, 189
- REG\_C
  - arch.h, 291
- reg\_config\_param
  - sim-config.c, 806
  - sim-config.h, 814
- reg\_config\_sec
  - sim-config.c, 808
  - sim-config.h, 816
- reg\_config\_secs
  - sim-config.c, 808
  - sim-config.h, 816
- reg\_cpu\_sec
  - cpu-config.c, 208
  - cpu-config.h, 210
- reg\_cuc\_sec
  - cuc.c, 462
  - cuc.h, 479
- reg\_dc\_sec
  - dcache-model.c, 193
  - dcache-model.h, 197
- reg\_debug\_sec
  - debug-unit.c, 521
  - debug-unit.h, 527
- reg\_dep
  - bb.c, 446
  - cuc.h, 479
- reg\_dep\_rec
  - bb.c, 446
- reg\_dma\_sec
  - dma.c, 696
  - dma.h, 698
- reg\_dmmu\_sec
  - dmmu.c, 576
  - dmmu.h, 579
- reg\_ethernet\_sec
  - eth.c, 712
  - eth.h, 714
- reg\_fb\_sec
  - fb.c, 720
  - fb.h, 722
- reg\_generic\_sec
  - generic.c, 729
  - generic.h, 731
- reg\_gpio\_sec
  - gpio.c, 739
  - gpio.h, 740
- reg\_ic\_sec
  - icache-model.c, 202
  - icache-model.h, 204
- reg\_immu\_sec
  - immu.c, 585
  - immu.h, 587
- reg\_kbd\_sec
  - ps2kbd.c, 758
  - ps2kbd.h, 760
- reg\_mc\_sec
  - mc.c, 747
  - mc.h, 750
- reg\_mem\_area
  - abstract.c, 220
  - abstract.h, 237
- reg\_memory\_sec
  - memory.h, 752
  - peripheral/memory.c, 505
- reg\_pic\_sec
  - pic.c, 770
  - pic.h, 772
- reg\_pm\_sec
  - pm.c, 774
  - pm.h, 776
- reg\_sim\_reset
  - toplevel-support.c, 856
  - toplevel-support.h, 861
- reg\_sim\_sec
  - sim-config.c, 809
- reg\_sim\_stat
  - sim-cmd.c, 790
  - sim-cmd.h, 802
- reg\_t
  - op\_queue, 158
- reg\_uart\_sec
  - 16450.c, 607
  - 16450.h, 622
- reg\_vapi\_sec
  - vapi.c, 870
  - vapi.h, 875
- reg\_vga\_sec
  - vga.c, 763
  - vga.h, 767
- register\_memoryarea\_mask
  - abstract.c, 221
- regs

- ata\_device, 22
- ata\_host, 26
- dev\_16450, 74
- dma\_channel, 81
- dma\_controller, 84
- eth\_device, 113
- reloc, 161
  - addend, 161
  - cuc.h, 481
  - func\_offset, 161
  - load.c, 498
  - name, 161
  - type, 161
- relocate\_bb
  - bb.c, 446
- remove\_breakpoint
  - labels.c, 269
  - labels.h, 271
- remove\_dead
  - cuc.h, 480
  - insn.c, 486
- remove\_dead\_bb
  - bb.c, 446
  - cuc.h, 480
- remove\_dslots
  - load.c, 497
- remove\_nops
  - cuc.h, 480
  - insn.c, 486
- remove\_trivial\_regs
  - cuc.h, 480
  - insn.c, 487
- report\_interrupt
  - pic.c, 770
  - pic.h, 773
- reserved1
  - BMP\_HEADER, 29
- reserved2
  - BMP\_HEADER, 29
- reset\_cycles
  - runtime, 165
- reset\_hook
  - sim\_reset\_hook, 170
- reset\_instructions
  - runtime, 165
- RET\_OPCODE
  - dyngen-i386.c, 360
- ret\_spr
  - spr-dump.c, 309
- rev
  - ata\_host, 26
- rfds
  - eth\_device, 113
- RGPIO\_AUX
  - gpio.c, 735
- RGPIO\_CTRL
  - gpio.c, 735
- RGPIO\_CTRL\_ECLK
  - gpio.c, 735
- RGPIO\_CTRL\_INTE
  - gpio.c, 735
- RGPIO\_CTRL\_INTS
  - gpio.c, 735
- RGPIO\_CTRL\_NEC
  - gpio.c, 735
- RGPIO\_IN
  - gpio.c, 735
- RGPIO\_INTE
  - gpio.c, 735
- RGPIO\_INTS
  - gpio.c, 735
- RGPIO\_OE
  - gpio.c, 735
- RGPIO\_OUT
  - gpio.c, 735
- RGPIO\_PTRIG
  - gpio.c, 735
- RISCOP\_RESET
  - debug-unit.c, 515
- RISCOP\_STALL
  - debug-unit.c, 515
- roll\_loop
  - bb.c, 446
- rsp
  - rsp-server.c, 559
- rsp-server.c
  - ascii2hex, 541
  - BP\_HARDWARE, 540
  - BP\_MEMORY, 540
  - client\_fd, 559
  - client\_waiting, 559
  - GDB\_BUF\_MAX, 539
  - get\_packet, 541
  - get\_rsp\_char, 541
  - handle\_rsp, 542
  - hex, 543
  - hex2ascii, 544
  - hex2reg, 544
  - hexchars, 559
  - mp\_hash, 559
  - mp\_hash\_add, 544
  - mp\_hash\_delete, 544
  - mp\_hash\_init, 545
  - mp\_hash\_lookup, 545
  - MP\_HASH\_SIZE, 539
  - mp\_type, 540
  - NPC\_REGNUM, 539
  - NUM\_REGS, 540

- OR1K\_TRAP\_INSTR, 540
- OR1KSIM\_RSP\_PROTOCOL, 540
- OR1KSIM\_RSP\_SERVICE, 540
- OR1KSIM\_TID, 540
- PPC\_REGNUM, 540
- proto\_num, 559
- put\_packet, 545
- put\_rsp\_char, 546
- put\_str\_packet, 546
- reg2hex, 546
- rsp, 559
- rsp\_client\_close, 546
- rsp\_client\_request, 547
- rsp\_command, 548
- rsp\_continue, 549
- rsp\_continue\_generic, 549
- rsp\_continue\_with\_signal, 550
- rsp\_exception, 550
- rsp\_get\_client, 550
- rsp\_init, 551
- rsp\_insert\_matchpoint, 551
- rsp\_query, 552
- rsp\_read\_all\_regs, 552
- rsp\_read\_mem, 553
- rsp\_read\_reg, 553
- rsp\_remove\_matchpoint, 554
- rsp\_report\_exception, 554
- rsp\_restart, 555
- rsp\_set, 555
- rsp\_step, 555
- rsp\_step\_generic, 555
- rsp\_step\_with\_signal, 556
- rsp\_unescape, 556
- rsp\_vpkt, 556
- rsp\_write\_all\_regs, 557
- rsp\_write\_mem, 557
- rsp\_write\_mem\_bin, 558
- rsp\_write\_reg, 558
- set\_npc, 559
- sigval, 559
- SR\_REGNUM, 540
- start\_addr, 560
- TARGET\_SIGNAL\_ALRM, 541
- TARGET\_SIGNAL\_BUS, 541
- TARGET\_SIGNAL\_FPE, 541
- TARGET\_SIGNAL\_ILL, 541
- TARGET\_SIGNAL\_INT, 541
- TARGET\_SIGNAL\_NONE, 541
- TARGET\_SIGNAL\_PWR, 541
- TARGET\_SIGNAL\_SEGV, 541
- TARGET\_SIGNAL\_TRAP, 541
- TARGET\_SIGNAL\_USR2, 541
- target\_signal, 540
- WP\_ACCESS, 540
- WP\_READ, 540
- WP\_WRITE, 540
- rsp-server.h
  - handle\_rsp, 561
  - rsp\_exception, 562
  - rsp\_init, 563
- rsp\_buf, 162
  - data, 162
  - len, 162
- rsp\_client\_close
  - rsp-server.c, 546
- rsp\_client\_request
  - rsp-server.c, 547
- rsp\_command
  - rsp-server.c, 548
- rsp\_continue
  - rsp-server.c, 549
- rsp\_continue\_generic
  - rsp-server.c, 549
- rsp\_continue\_with\_signal
  - rsp-server.c, 550
- rsp\_enabled
  - config, 55
- rsp\_exception
  - rsp-server.c, 550
  - rsp-server.h, 562
- rsp\_get\_client
  - rsp-server.c, 550
- rsp\_init
  - rsp-server.c, 551
  - rsp-server.h, 563
- rsp\_insert\_matchpoint
  - rsp-server.c, 551
- rsp\_port
  - config, 55
- rsp\_query
  - rsp-server.c, 552
- rsp\_read\_all\_regs
  - rsp-server.c, 552
- rsp\_read\_mem
  - rsp-server.c, 553
- rsp\_read\_reg
  - rsp-server.c, 553
- rsp\_remove\_matchpoint
  - rsp-server.c, 554
- rsp\_report\_exception
  - rsp-server.c, 554
- rsp\_restart
  - rsp-server.c, 555
- rsp\_set
  - rsp-server.c, 555
- rsp\_step
  - rsp-server.c, 555
- rsp\_step\_generic

- rsp-server.c, 555
- rsp\_step\_with\_signal
  - rsp-server.c, 556
- rsp\_unescape
  - rsp-server.c, 556
- rsp\_vpkt
  - rsp-server.c, 556
- rsp\_write\_all\_regs
  - rsp-server.c, 557
- rsp\_write\_mem
  - rsp-server.c, 557
- rsp\_write\_mem\_bin
  - rsp-server.c, 558
- rsp\_write\_reg
  - rsp-server.c, 558
- rtl
  - cuc\_known\_insn, 66
- rtx\_sock
  - eth\_device, 113
- rtx\_type
  - eth\_device, 113
- run\_sched\_out\_of\_line
  - dyn-rec.c, 349
  - dyn-rec.h, 355
- runtime, 163
  - cpu, 165
  - cuc, 165
  - cycle\_duration, 165
  - cycles, 165
  - enabled, 165
  - end\_cycles, 165
  - ext\_int\_clr, 165
  - ext\_int\_set, 165
  - fexe\_log, 165
  - filename, 165
  - fmprof, 165
  - fout, 165
  - fprof, 165
  - hazardwait, 165
  - hush, 165
  - instructions, 165
  - iprompt, 165
  - iprompt\_run, 165
  - loadcycles, 165
  - mdelay, 165
  - mem\_cycles, 165
  - reset\_cycles, 165
  - reset\_instructions, 165
  - server\_port, 165
  - sim, 165
  - sim-config.c, 811
  - sim-config.h, 817
  - stalled, 165
  - storecycles, 165
  - supercycles, 165
  - time\_point, 165
  - vapi, 165
  - vapi\_file, 165
- rx
  - eth\_device, 113
- rx\_buff
  - eth\_device, 113
- rx\_channel
  - eth\_device, 113
- rxb
  - ata\_host, 26
- rxbuf
  - dev\_16450, 74
- rxbuf\_full
  - dev\_16450, 74
- rxbuf\_head
  - dev\_16450, 74
- rxbuf\_tail
  - dev\_16450, 74
- rxfd
  - eth\_device, 113
- rxfile
  - eth\_device, 113
  - kbd\_state, 144
- rxfs
  - kbd\_state, 144
- rxser
  - dev\_16450, 74
- s\_flags
  - COFF\_scnhdr, 48
- S\_FUNC
  - op.c, 423
- s\_innoptr
  - COFF\_scnhdr, 48
- s\_name
  - COFF\_scnhdr, 48
- s\_nlnno
  - COFF\_scnhdr, 48
- s\_nreloc
  - COFF\_scnhdr, 48
- S\_OP\_NAME
  - op.c, 423
- s\_paddr
  - COFF\_scnhdr, 48
- s\_relptr
  - COFF\_scnhdr, 48
- s\_scnptr
  - COFF\_scnhdr, 48
- s\_size
  - COFF\_scnhdr, 48
- s\_vaddr
  - COFF\_scnhdr, 48



- same\_transfers
  - cuc/memory.c, 500
- save\_t\_bound
  - op.c, 429
- saved\_regs
  - \_cuc\_func, 16
- sbp\_bf\_fwd
  - config, 55
- sbp\_bnf\_fwd
  - config, 55
- sbuf\_buf
  - execute.c, 376
- sbuf\_count
  - execute.c, 376
- sbuf\_head
  - execute.c, 376
- sbuf\_len
  - config, 55
- sbuf\_load
  - execute.c, 374
- sbuf\_prev\_cycles
  - execute.c, 376
- sbuf\_store
  - execute.c, 375
- sbuf\_tail
  - execute.c, 376
- sbuf\_total\_cyc
  - execute.c, 376
  - execute.h, 267
- sbuf\_wait\_cyc
  - execute.c, 376
  - execute.h, 267
- scan\_decode
  - ps2kbd.c, 759
- scan\_table
  - ps2kbd.c, 759
- sched-i386.h
  - set\_sched\_cycle, 438
- sched.c
  - DECLARE\_DEBUG\_CHANNEL, 836
  - do\_scheduler, 836
  - sched\_add, 836
  - sched\_find\_remove, 836
  - sched\_guard, 836
  - SCHED\_HEAP\_SIZE, 836
  - sched\_init, 836
  - sched\_next\_insn, 836
  - sched\_reset, 836
  - SCHED\_TIME\_MAX, 836
  - scheduler, 836
- sched.h
  - do\_scheduler, 838
  - SCHED\_ADD, 837
  - sched\_add, 838
  - SCHED\_FIND\_REMOVE, 837
  - sched\_find\_remove, 838
  - sched\_init, 838
  - sched\_next\_insn, 838
  - sched\_reset, 838
  - scheduler, 838
- SCHED\_ADD
  - sched.h, 837
- sched\_add
  - sched.c, 836
  - sched.h, 838
- sched\_entry, 167
  - func, 167
  - next, 167
  - param, 167
  - time, 167
- SCHED\_FIND\_REMOVE
  - sched.h, 837
- sched\_find\_remove
  - sched.c, 836
  - sched.h, 838
- sched\_guard
  - sched.c, 836
- SCHED\_HEAP\_SIZE
  - sched.c, 836
- sched\_init
  - sched.c, 836
  - sched.h, 838
- sched\_next\_insn
  - sched.c, 836
  - sched.h, 838
- sched\_reset
  - sched.c, 836
  - sched.h, 838
- SCHED\_TIME\_MAX
  - sched.c, 836
- sched\_timer\_job
  - tick.c, 843
- schedule\_memory
  - cuc.h, 480
  - cuc/memory.c, 500
- scheduler
  - sched.c, 836
  - sched.h, 838
- scheduler\_struct, 168
  - free\_job\_queue, 168
  - job\_queue, 168
- scr
  - dev\_16450, 74
- SD
  - stats.c, 281
- search\_csm
  - insn.c, 487
- sec\_end

- config\_section, 59
- sec\_start
  - config\_section, 59
- sections
  - sim-config.c, 811
- sector\_count
  - ata\_device, 22
- sector\_number
  - ata\_device, 22
- sectors
  - ata\_device, 22
- sectors\_per\_track
  - ata\_device, 22
- SECURITY\_DISABLE\_PASSWORD
  - atacmd.h, 627
- SECURITY\_ERASE\_PREPARE
  - atacmd.h, 627
- SECURITY\_ERASE\_UNIT
  - atacmd.h, 627
- SECURITY\_FREEZE\_LOCK
  - atacmd.h, 627
- SECURITY\_SET\_PASSWORD
  - atacmd.h, 627
- SECURITY\_UNLOCK
  - atacmd.h, 627
- SEEK
  - atacmd.h, 627
- selected\_tim
  - cuc\_bb, 63
- SELFMAG
  - elf.h, 260
- send\_char
  - 16450.c, 608
- server\_fd
  - gdbcomm.c, 534
  - vapi.c, 873
- server\_ip
  - gdbcomm.c, 534
- server\_port
  - config, 55
  - gdbcomm.c, 534
  - runtime, 165
- server\_request
  - vapi.c, 870
- serverIP
  - vapi.c, 873
- SERVICE
  - atacmd.h, 627
- set\_config
  - sim-config.c, 809
- set\_config\_command
  - sim-config.c, 810
  - sim-config.h, 817
- set\_csc\_tms
  - mc.c, 748
- set\_devint\_reg
  - debug-unit.c, 522
- set\_direct16
  - abstract.c, 221
  - abstract.h, 238
- set\_direct32
  - abstract.c, 222
  - abstract.h, 238
- set\_direct8
  - abstract.c, 222
  - abstract.h, 239
- set\_dma\_nd\_i
  - dma.c, 696
  - dma.h, 698
- set\_dma\_req\_i
  - dma.c, 696
  - dma.h, 698
- SET\_FEATURES
  - atacmd.h, 627
- SET\_FEATURES\_REQUIRED\_AFTER\_-  
POWER\_UP
  - atadevice-cmdi.h, 636
- SET\_FIELD
  - fields.h, 724
- SET\_FLAG
  - fields.h, 724
- set\_func\_deps
  - cuc.c, 462
- set\_insnbrkpoint
  - trace.c, 286
  - trace.h, 288
- set\_io
  - cuc.h, 481
  - insn.c, 487
- set\_mask
  - dmmu, 86
  - ic, 127
  - immu, 129
- SET\_MAX
  - atacmd.h, 627
- SET\_MAX\_ADDRESS
  - atacmd.h, 627
- SET\_MAX\_FREEZE\_LOCK
  - atacmd.h, 627
- SET\_MAX\_LOCK
  - atacmd.h, 627
- SET\_MAX\_SET\_PASSWORD
  - atacmd.h, 627
- SET\_MAX\_UNLOCK
  - atacmd.h, 627
- set\_mem16
  - abstract.c, 223
  - abstract.h, 239

- set\_mem32
  - abstract.c, [223](#)
  - abstract.h, [240](#)
- set\_mem8
  - abstract.c, [224](#)
  - abstract.h, [240](#)
- set\_mem\_16\_inv
  - abstract.c, [224](#)
- set\_mem\_16\_inv\_direct
  - abstract.c, [225](#)
- set\_mem\_32\_inv
  - abstract.c, [225](#)
- set\_mem\_32\_inv\_direct
  - abstract.c, [225](#)
- set\_mem\_8\_inv
  - abstract.c, [226](#)
- set\_mem\_8\_inv\_direct
  - abstract.c, [226](#)
- set\_mem\_valid
  - abstract.c, [226](#)
  - abstract.h, [241](#)
- SET\_MULTIPLE\_MODE
  - atacmd.h, [627](#)
- set\_npc
  - rsp-server.c, [559](#)
- SET\_OV\_FLAG\_FN
  - execute.h, [262](#)
- set\_pc
  - common-i386.h, [325](#)
- set\_pc\_delay\_gpr
  - dyn-rec.c, [350](#)
- set\_program32
  - abstract.c, [226](#)
  - abstract.h, [241](#)
- set\_program8
  - abstract.c, [226](#)
  - abstract.h, [241](#)
- set\_sched\_cycle
  - sched-i386.h, [438](#)
- set\_stall\_state
  - debug-unit.c, [523](#)
  - debug-unit.h, [528](#)
- SET\_TRANSFER\_MODE\_SECTOR\_COUNT\_-REG
  - atacmd.h, [627](#)
- setsim\_mem16
  - abstract.c, [226](#)
  - abstract.h, [241](#)
- setsim\_mem32
  - abstract.c, [227](#)
  - abstract.h, [242](#)
- setsim\_mem8
  - abstract.c, [227](#)
  - abstract.h, [242](#)
- setsim\_reg
  - execute.c, [375](#)
  - execute.h, [267](#)
- sh\_addr
  - elf32\_shdr, [97](#)
  - elf64\_shdr, [106](#)
- sh\_addralign
  - elf32\_shdr, [97](#)
  - elf64\_shdr, [106](#)
- sh\_entsize
  - elf32\_shdr, [97](#)
  - elf64\_shdr, [106](#)
- sh\_flags
  - elf32\_shdr, [97](#)
  - elf64\_shdr, [106](#)
- sh\_info
  - elf32\_shdr, [97](#)
  - elf64\_shdr, [106](#)
- sh\_link
  - elf32\_shdr, [97](#)
  - elf64\_shdr, [106](#)
- sh\_name
  - elf32\_shdr, [97](#)
  - elf64\_shdr, [106](#)
- sh\_offset
  - elf32\_shdr, [97](#)
  - elf64\_shdr, [106](#)
- sh\_size
  - elf32\_shdr, [97](#)
  - elf64\_shdr, [106](#)
- sh\_type
  - elf32\_shdr, [97](#)
  - elf64\_shdr, [106](#)
- shared
  - cuc\_timings, [69](#)
- SHF\_ALLOC
  - elf.h, [260](#)
- SHF\_EXECINSTR
  - elf.h, [260](#)
- SHF\_MASKPROC
  - elf.h, [260](#)
- SHF\_WRITE
  - elf.h, [260](#)
- shift
  - ps2kbd.c, [759](#)
- shift\_fprintf
  - generate.c, [379](#)
- ship\_gprs\_out\_t
  - dyn-rec.c, [350](#)
- ship\_t\_out
  - dyn-rec.c, [350](#)
- SHN\_ABS
  - elf.h, [260](#)
- SHN\_COMMON

- elf.h, 260
- SHN\_HIPROC
  - elf.h, 260
- SHN\_HIRESERVE
  - elf.h, 260
- SHN\_LOPROC
  - elf.h, 260
- SHN\_LORESERVE
  - elf.h, 260
- SHN\_UNDEF
  - elf.h, 260
- SHT\_DYNAMIC
  - elf.h, 260
- SHT\_DYNSYM
  - elf.h, 260
- SHT\_HASH
  - elf.h, 260
- SHT\_HIPROC
  - elf.h, 260
- SHT\_HIUSER
  - elf.h, 260
- SHT\_LOPROC
  - elf.h, 260
- SHT\_LOUSER
  - elf.h, 260
- SHT\_NOBITS
  - elf.h, 260
- SHT\_NOTE
  - elf.h, 260
- SHT\_NULL
  - elf.h, 260
- SHT\_NUM
  - elf.h, 260
- SHT\_PROGBITS
  - elf.h, 260
- SHT\_REL
  - elf.h, 260
- SHT\_RELA
  - elf.h, 260
- SHT\_SHLIB
  - elf.h, 260
- SHT\_STRTAB
  - elf.h, 260
- SHT\_SYMTAB
  - elf.h, 260
- sigs
  - ata\_device, 22
- sigsegv\_addr
  - dyn-rec.c, 351
- sigsegv\_state
  - dyn-rec.c, 351
- sigval
  - rsp-server.c, 559
- sim
  - config, 55
  - runtime, 165
- sim-cmd.c, 786
  - check\_insn\_exec, 788
  - handle\_sim\_command, 788
  - print\_insn\_exec, 789
  - reenter\_int, 790
  - reg\_sim\_stat, 790
  - sim\_cmd\_break, 791
  - sim\_cmd\_breaks, 791
  - sim\_cmd\_cm, 791
  - sim\_cmd\_cuc, 791
  - sim\_cmd\_de, 794
  - sim\_cmd\_debug, 794
  - sim\_cmd\_dh, 794
  - sim\_cmd\_dm, 794
  - sim\_cmd\_dv, 795
  - sim\_cmd\_help, 795
  - sim\_cmd\_hist, 795
  - sim\_cmd\_info, 796
  - sim\_cmd\_mprofile, 796
  - sim\_cmd\_pc, 796
  - sim\_cmd\_pm, 797
  - sim\_cmd\_pr, 797
  - sim\_cmd\_profile, 797
  - sim\_cmd\_quit, 797
  - sim\_cmd\_r, 798
  - sim\_cmd\_reset, 798
  - sim\_cmd\_run, 798
  - sim\_cmd\_set, 799
  - sim\_cmd\_setdbch, 799
  - sim\_cmd\_stall, 799
  - sim\_cmd\_stats, 799
  - sim\_cmd\_trace, 800
  - sim\_cmd\_unstall, 800
  - sim\_commands, 801
  - sim\_stats, 801
  - strip\_space, 800
  - to\_insn\_num, 801
- sim-cmd.h, 802
  - handle\_sim\_command, 802
  - reg\_sim\_stat, 802
- sim-config.c, 803
  - base\_include, 805
  - config, 811
  - cur\_section, 811
  - init\_defconfig, 805
  - parse\_args, 805
  - print\_config, 805
  - read\_script\_file, 806
  - reg\_config\_param, 806
  - reg\_config\_sec, 808
  - reg\_config\_secs, 808
  - reg\_sim\_sec, 809

- runtime, 811
- sections, 811
- set\_config, 809
- set\_config\_command, 810
- sim\_clkcycle, 810
- sim\_debug, 810
- sim\_exe\_log, 810
- sim\_exe\_log\_end, 811
- sim\_exe\_log\_fn, 811
- sim\_exe\_log\_marker, 811
- sim\_exe\_log\_start, 811
- sim\_exe\_log\_type, 811
- sim\_history, 811
- sim\_mprof\_fn, 811
- sim\_mprofile, 811
- sim\_prof\_fn, 811
- sim\_profile, 811
- sim\_verbose, 811
- switch\_param, 811
- sim-config.h, 812
  - CHECK\_INT\_TIME, 813
  - config, 817
  - cur\_section, 817
  - do\_stats, 817
  - EXE\_LOG\_HARDWARE, 813
  - EXE\_LOG\_SIMPLE, 813
  - EXE\_LOG\_SOFTWARE, 813
  - init\_defconfig, 814
  - MAX\_SBUF\_LEN, 813
  - param\_t, 813
  - paramt\_addr, 813
  - paramt\_int, 813
  - paramt\_longlong, 813
  - paramt\_none, 813
  - paramt\_str, 813
  - paramt\_word, 813
  - parse\_args, 814
  - print\_config, 814
  - PRINTF, 813
  - reg\_config\_param, 814
  - reg\_config\_sec, 816
  - reg\_config\_secs, 816
  - runtime, 817
  - set\_config\_command, 817
  - STR\_SIZE, 813
- sim\_clkcycle
  - sim-config.c, 810
- sim\_cmd\_break
  - sim-cmd.c, 791
- sim\_cmd\_breaks
  - sim-cmd.c, 791
- sim\_cmd\_cm
  - sim-cmd.c, 791
- sim\_cmd\_cuc
  - sim-cmd.c, 791
- sim\_cmd\_de
  - sim-cmd.c, 794
- sim\_cmd\_debug
  - sim-cmd.c, 794
- sim\_cmd\_dh
  - sim-cmd.c, 794
- sim\_cmd\_dm
  - sim-cmd.c, 794
- sim\_cmd\_dv
  - sim-cmd.c, 795
- sim\_cmd\_help
  - sim-cmd.c, 795
- sim\_cmd\_hist
  - sim-cmd.c, 795
- sim\_cmd\_info
  - sim-cmd.c, 796
- sim\_cmd\_mprofile
  - sim-cmd.c, 796
- sim\_cmd\_pc
  - sim-cmd.c, 796
- sim\_cmd\_pm
  - sim-cmd.c, 797
- sim\_cmd\_pr
  - sim-cmd.c, 797
- sim\_cmd\_profile
  - sim-cmd.c, 797
- sim\_cmd\_quit
  - sim-cmd.c, 797
- sim\_cmd\_r
  - sim-cmd.c, 798
- sim\_cmd\_reset
  - sim-cmd.c, 798
- sim\_cmd\_run
  - sim-cmd.c, 798
- sim\_cmd\_set
  - sim-cmd.c, 799
- sim\_cmd\_setdbch
  - sim-cmd.c, 799
- sim\_cmd\_stall
  - sim-cmd.c, 799
- sim\_cmd\_stats
  - sim-cmd.c, 799
- sim\_cmd\_trace
  - sim-cmd.c, 800
- sim\_cmd\_unstall
  - sim-cmd.c, 800
- sim\_command, 169
  - cmd\_handle, 169
  - name, 169
- sim\_commands
  - sim-cmd.c, 801
- sim\_debug
  - sim-config.c, 810

- sim\_done
  - toplevel-support.c, 857
  - toplevel-support.h, 862
- sim\_exe\_log
  - sim-config.c, 810
- sim\_exe\_log\_end
  - sim-config.c, 811
- sim\_exe\_log\_fn
  - sim-config.c, 811
- sim\_exe\_log\_marker
  - sim-config.c, 811
- sim\_exe\_log\_start
  - sim-config.c, 811
- sim\_exe\_log\_type
  - sim-config.c, 811
- sim\_history
  - sim-config.c, 811
- sim\_init
  - toplevel-support.c, 857
  - toplevel-support.h, 862
- sim\_mprof\_fn
  - sim-config.c, 811
- sim\_mprofile
  - sim-config.c, 811
- sim\_prof\_fn
  - sim-config.c, 811
- sim\_profile
  - sim-config.c, 811
- sim\_reset
  - toplevel-support.c, 858
  - toplevel-support.h, 863
- sim\_reset\_hook, 170
  - dat, 170
  - next, 170
  - reset\_hook, 170
- sim\_reset\_hooks
  - toplevel-support.c, 859
- sim\_stat, 171
  - dat, 171
  - next, 171
  - stat\_func, 171
- sim\_stats
  - sim-cmd.c, 801
- sim\_verbose
  - sim-config.c, 811
- simgetstr
  - simprintf.c, 840
- simmem\_read16
  - peripheral/memory.c, 505
- simmem\_read32
  - peripheral/memory.c, 506
- simmem\_read8
  - peripheral/memory.c, 506
- simmem\_read\_zero16
  - peripheral/memory.c, 506
- simmem\_read\_zero32
  - peripheral/memory.c, 506
- simmem\_read\_zero8
  - peripheral/memory.c, 506
- simmem\_write16
  - peripheral/memory.c, 506
- simmem\_write32
  - peripheral/memory.c, 506
- simmem\_write8
  - peripheral/memory.c, 506
- simmem\_write\_null16
  - peripheral/memory.c, 506
- simmem\_write\_null32
  - peripheral/memory.c, 506
- simmem\_write\_null8
  - peripheral/memory.c, 506
- simpl32-defs.h
  - PARAMS, 439
- simplify\_bb
  - bb.c, 446
- simprintf
  - simprintf.c, 840
  - simprintf.h, 841
- simprintf.c
  - FMTLEN, 840
  - fmtstr, 840
  - simgetstr, 840
  - simprintf, 840
  - STACK\_ARGS, 840
- simprintf.h
  - simprintf, 841
- size
  - \_csm\_list, 14
  - ata\_device, 22
  - BMP\_HEADER, 29
  - cuc\_timing\_table, 68
  - cuc\_timings, 69
  - dev\_generic, 77
  - dev\_memarea, 79
  - INFOHEADER, 131
  - mem\_config, 150
- size\_mask
  - dev\_memarea, 79
- size\_sect
  - ata\_device, 22
- sizei
  - cuc\_timing\_table, 68
- skew
  - dev\_16450, 74
- sl\_entsz
  - COFF\_slib, 49
- sl\_pathndx
  - COFF\_slib, 49

- SLEEP
  - atacmd.h, 627
- slowdown
  - kbd\_state, 144
- SMART
  - atacmd.h, 627
- SMART\_ATTRIBITE\_AUTOSAVE
  - atacmd.h, 627
- SMART\_DISABLE\_OPERATIONS
  - atacmd.h, 627
- SMART\_ENABLE\_OPERATIONS
  - atacmd.h, 627
- SMART\_EXECUTE\_OFFLINE\_IMMEDIATE
  - atacmd.h, 627
- SMART\_READ\_DATA
  - atacmd.h, 627
- SMART\_READ\_LOG
  - atacmd.h, 627
- SMART\_RETURN\_STATUS
  - atacmd.h, 627
- SMART\_SAVE\_ATTRIBUTE\_VALUES
  - atacmd.h, 627
- SMART\_WRITE\_LOG
  - atacmd.h, 627
- socket\_fd
  - tcp\_channel, 176
- sockif
  - eth\_device, 113
- source
  - dma\_channel, 81
- source\_mask
  - dma\_channel, 81
- SPEEDY\_CALL
  - op-i386.h, 403
- spr-defs.h
  - MATCHPOINTS\_TO\_NDP, 305
  - MAX\_GRPS, 305
  - MAX\_MATCHPOINTS, 307
  - MAX\_SPRS, 307
  - MAX\_SPRS\_PER\_GRP, 307
  - MAX\_SPRS\_PER\_GRP\_BITS, 307
  - MAX\_WATCHPOINTS, 307
  - NOP\_CNT\_RESET, 307
  - NOP\_EXIT, 307
  - NOP\_NOP, 307
  - NOP\_PRINTF, 307
  - NOP\_PUTC, 307
  - NOP\_REPORT, 307
  - NOP\_REPORT\_FIRST, 307
  - NOP\_REPORT\_LAST, 307
  - SPR\_CPUCFGR, 307
  - SPR\_CPUCFGR\_CGF, 307
  - SPR\_CPUCFGR\_NSFG, 307
  - SPR\_CPUCFGR\_OB32S, 307
  - SPR\_CPUCFGR\_OB64S, 307
  - SPR\_CPUCFGR\_OF32S, 307
  - SPR\_CPUCFGR\_OF64S, 307
  - SPR\_CPUCFGR\_OV64S, 307
  - SPR\_CPUCFGR\_RES, 307
  - SPR\_DCBFR, 307
  - SPR\_DCBIR, 307
  - SPR\_DCBLR, 307
  - SPR\_DCBPR, 307
  - SPR\_DCBWR, 307
  - SPR\_DCCFGR, 307
  - SPR\_DCCFGR\_CBFRI, 307
  - SPR\_DCCFGR\_CBIRI, 307
  - SPR\_DCCFGR\_CBLRI, 307
  - SPR\_DCCFGR\_CBPRI, 307
  - SPR\_DCCFGR\_CBS, 307
  - SPR\_DCCFGR\_CBS\_OFF, 307
  - SPR\_DCCFGR\_CBWBRI, 307
  - SPR\_DCCFGR\_CCRI, 307
  - SPR\_DCCFGR\_CWS, 307
  - SPR\_DCCFGR\_NCS, 307
  - SPR\_DCCFGR\_NCS\_OFF, 307
  - SPR\_DCCFGR\_NCW, 307
  - SPR\_DCCFGR\_NCW\_OFF, 307
  - SPR\_DCCR, 307
  - SPR\_DCCR\_EW, 307
  - SPR\_DCFGR, 307
  - SPR\_DCFGR\_NDP, 307
  - SPR\_DCFGR\_NDP1, 307
  - SPR\_DCFGR\_NDP2, 307
  - SPR\_DCFGR\_NDP3, 307
  - SPR\_DCFGR\_NDP4, 307
  - SPR\_DCFGR\_NDP5, 307
  - SPR\_DCFGR\_NDP6, 307
  - SPR\_DCFGR\_NDP7, 307
  - SPR\_DCFGR\_NDP8, 307
  - SPR\_DCFGR\_WPCI, 307
  - SPR\_DCR, 307
  - SPR\_DCR\_BASE, 307
  - SPR\_DCR\_CC, 307
  - SPR\_DCR\_CC\_EQUAL, 307
  - SPR\_DCR\_CC\_GREAT, 307
  - SPR\_DCR\_CC\_GREATE, 307
  - SPR\_DCR\_CC\_LESS, 307
  - SPR\_DCR\_CC\_LESSE, 307
  - SPR\_DCR\_CC\_MASKED, 307
  - SPR\_DCR\_CC\_NEQUAL, 307
  - SPR\_DCR\_CT, 307
  - SPR\_DCR\_CT\_DISABLED, 307
  - SPR\_DCR\_CT\_IFEA, 307
  - SPR\_DCR\_CT\_LD, 307
  - SPR\_DCR\_CT\_LEA, 307
  - SPR\_DCR\_CT\_LSD, 307
  - SPR\_DCR\_CT\_LSEA, 307

SPR\_DCR\_CT\_SD, 307  
SPR\_DCR\_CT\_SEA, 307  
SPR\_DCR\_DP, 307  
SPR\_DCR\_LAST, 307  
SPR\_DCR\_SC, 307  
SPR\_DMMUCFGR, 307  
SPR\_DMMUCFGR\_CRI, 307  
SPR\_DMMUCFGR\_HTR, 307  
SPR\_DMMUCFGR\_NAE, 307  
SPR\_DMMUCFGR\_NTS, 307  
SPR\_DMMUCFGR\_NTS\_OFF, 307  
SPR\_DMMUCFGR\_NTW, 307  
SPR\_DMMUCFGR\_NTW\_OFF, 307  
SPR\_DMMUCFGR\_PRI, 307  
SPR\_DMMUCFGR\_TEIRI, 307  
SPR\_DMMUCR, 307  
SPR\_DMMUCR\_P1S, 307  
SPR\_DMMUCR\_P2S, 307  
SPR\_DMMUCR\_PADDR\_WIDTH, 307  
SPR\_DMMUCR\_VADDR\_WIDTH, 307  
SPR\_DMR1, 307  
SPR\_DMR1\_BT, 307  
SPR\_DMR1\_CW, 307  
SPR\_DMR1\_CW0, 307  
SPR\_DMR1\_CW0\_AND, 307  
SPR\_DMR1\_CW0\_OR, 307  
SPR\_DMR1\_CW1, 307  
SPR\_DMR1\_CW1\_AND, 307  
SPR\_DMR1\_CW1\_OR, 307  
SPR\_DMR1\_CW2, 307  
SPR\_DMR1\_CW2\_AND, 307  
SPR\_DMR1\_CW2\_OR, 307  
SPR\_DMR1\_CW3, 307  
SPR\_DMR1\_CW3\_AND, 307  
SPR\_DMR1\_CW3\_OR, 307  
SPR\_DMR1\_CW4, 307  
SPR\_DMR1\_CW4\_AND, 307  
SPR\_DMR1\_CW4\_OR, 307  
SPR\_DMR1\_CW5, 307  
SPR\_DMR1\_CW5\_AND, 307  
SPR\_DMR1\_CW5\_OR, 307  
SPR\_DMR1\_CW6, 307  
SPR\_DMR1\_CW6\_AND, 307  
SPR\_DMR1\_CW6\_OR, 307  
SPR\_DMR1\_CW7, 307  
SPR\_DMR1\_CW7\_AND, 307  
SPR\_DMR1\_CW7\_OR, 307  
SPR\_DMR1\_CW8, 307  
SPR\_DMR1\_CW8\_AND, 307  
SPR\_DMR1\_CW8\_OR, 307  
SPR\_DMR1\_CW9, 307  
SPR\_DMR1\_CW9\_AND, 307  
SPR\_DMR1\_CW9\_OR, 307  
SPR\_DMR1\_RES1, 307  
SPR\_DMR1\_RES2, 307  
SPR\_DMR1\_ST, 307  
SPR\_DMR2, 307  
SPR\_DMR2\_AWTC, 307  
SPR\_DMR2\_AWTC\_OFF, 307  
SPR\_DMR2\_WBS, 307  
SPR\_DMR2\_WBS\_OFF, 307  
SPR\_DMR2\_WCE0, 307  
SPR\_DMR2\_WCE1, 307  
SPR\_DMR2\_WGB, 307  
SPR\_DMR2\_WGB\_OFF, 307  
SPR\_DRR, 307  
SPR\_DRR\_AE, 307  
SPR\_DRR\_BUSEE, 307  
SPR\_DRR\_DME, 307  
SPR\_DRR\_DPFE, 307  
SPR\_DRR\_FPE, 307  
SPR\_DRR\_IE, 307  
SPR\_DRR\_IIE, 307  
SPR\_DRR\_IME, 307  
SPR\_DRR\_IPFE, 307  
SPR\_DRR\_RE, 307  
SPR\_DRR\_RSTE, 307  
SPR\_DRR\_SCE, 307  
SPR\_DRR\_TE, 307  
SPR\_DRR\_TTE, 307  
SPR\_DSR, 307  
SPR\_DSR\_AE, 307  
SPR\_DSR\_BUSEE, 307  
SPR\_DSR\_DME, 307  
SPR\_DSR\_DPFE, 307  
SPR\_DSR\_FPE, 307  
SPR\_DSR\_IE, 307  
SPR\_DSR\_IIE, 307  
SPR\_DSR\_IME, 307  
SPR\_DSR\_IPFE, 307  
SPR\_DSR\_RE, 307  
SPR\_DSR\_RSTE, 307  
SPR\_DSR\_SCE, 307  
SPR\_DSR\_TE, 307  
SPR\_DSR\_TTE, 307  
SPR\_DTLBMR\_BASE, 307  
SPR\_DTLBMR\_CID, 307  
SPR\_DTLBMR\_LAST, 307  
SPR\_DTLBMR\_LRU, 307  
SPR\_DTLBMR\_PL1, 307  
SPR\_DTLBMR\_V, 307  
SPR\_DTLBMR\_VPN, 307  
SPR\_DTLBTR\_A, 307  
SPR\_DTLBTR\_BASE, 307  
SPR\_DTLBTR\_CC, 307  
SPR\_DTLBTR\_CI, 307  
SPR\_DTLBTR\_D, 307  
SPR\_DTLBTR\_LAST, 307



SPR\_DTLBTR\_PPN, 307  
SPR\_DTLBTR\_SRE, 307  
SPR\_DTLBTR\_SWE, 307  
SPR\_DTLBTR\_URE, 307  
SPR\_DTLBTR\_UWE, 307  
SPR\_DTLBTR\_WBC, 307  
SPR\_DTLBTR\_WOM, 307  
SPR\_DVR, 307  
SPR\_DWCR0, 307  
SPR\_DWCR1, 307  
SPR\_DWCR\_COUNT, 307  
SPR\_DWCR\_MATCH, 307  
SPR\_DWCR\_MATCH\_OFF, 307  
SPR\_EEAR\_BASE, 307  
SPR\_EEAR\_LAST, 307  
SPR\_EPCR\_BASE, 307  
SPR\_EPCR\_LAST, 307  
SPR\_ESR\_BASE, 307  
SPR\_ESR\_LAST, 307  
SPR\_ICBIR, 307  
SPR\_ICBLR, 307  
SPR\_ICBPR, 307  
SPR\_ICCFGR, 307  
SPR\_ICCFGR\_CBIRI, 307  
SPR\_ICCFGR\_CBLRI, 307  
SPR\_ICCFGR\_CBPRI, 307  
SPR\_ICCFGR\_CBS, 307  
SPR\_ICCFGR\_CBS\_OFF, 307  
SPR\_ICCFGR\_CCRI, 307  
SPR\_ICCFGR\_NCS, 307  
SPR\_ICCFGR\_NCS\_OFF, 307  
SPR\_ICCFGR\_NCW, 307  
SPR\_ICCFGR\_NCW\_OFF, 307  
SPR\_ICCR, 307  
SPR\_ICCR\_EW, 307  
SPR\_ICR\_BASE, 307  
SPR\_ICR\_LAST, 307  
SPR\_IMMUCFGR, 307  
SPR\_IMMUCFGR\_CRI, 307  
SPR\_IMMUCFGR\_HTR, 307  
SPR\_IMMUCFGR\_NAE, 307  
SPR\_IMMUCFGR\_NTS, 307  
SPR\_IMMUCFGR\_NTS\_OFF, 307  
SPR\_IMMUCFGR\_NTW, 307  
SPR\_IMMUCFGR\_NTW\_OFF, 307  
SPR\_IMMUCFGR\_PRI, 307  
SPR\_IMMUCFGR\_TEIRI, 307  
SPR\_IMMUCR, 307  
SPR\_IMMUCR\_P1S, 307  
SPR\_IMMUCR\_P2S, 307  
SPR\_IMMUCR\_PADDR\_WIDTH, 307  
SPR\_IMMUCR\_VADDR\_WIDTH, 307  
SPR\_ITLBMR\_BASE, 307  
SPR\_ITLBMR\_CID, 307  
SPR\_ITLBMR\_LAST, 307  
SPR\_ITLBMR\_LRU, 307  
SPR\_ITLBMR\_PL1, 307  
SPR\_ITLBMR\_V, 307  
SPR\_ITLBMR\_VPN, 307  
SPR\_ITLBTR\_A, 307  
SPR\_ITLBTR\_BASE, 307  
SPR\_ITLBTR\_CC, 307  
SPR\_ITLBTR\_CI, 307  
SPR\_ITLBTR\_D, 307  
SPR\_ITLBTR\_LAST, 307  
SPR\_ITLBTR\_PPN, 307  
SPR\_ITLBTR\_SXE, 307  
SPR\_ITLBTR\_UXE, 307  
SPR\_ITLBTR\_WBC, 307  
SPR\_ITLBTR\_WOM, 307  
SPR\_MACHI, 307  
SPR\_MACLO, 307  
SPR\_NPC, 307  
SPR\_PCCFGR, 307  
SPR\_PCCR, 307  
SPR\_PCMR, 307  
SPR\_PCMR\_BS, 307  
SPR\_PCMR\_CISM, 307  
SPR\_PCMR\_CIUM, 307  
SPR\_PCMR\_CP, 307  
SPR\_PCMR\_DCM, 307  
SPR\_PCMR\_DDS, 307  
SPR\_PCMR\_DTLBM, 307  
SPR\_PCMR\_ICM, 307  
SPR\_PCMR\_IF, 307  
SPR\_PCMR\_IFS, 307  
SPR\_PCMR\_ITLBM, 307  
SPR\_PCMR\_LA, 307  
SPR\_PCMR\_LSUS, 307  
SPR\_PCMR\_SA, 307  
SPR\_PCMR\_UMRA, 307  
SPR\_PCMR\_WPE, 307  
SPR\_PICMR, 307  
SPR\_PICMR\_IUM, 307  
SPR\_PICPR, 307  
SPR\_PICPR\_IPRIO, 307  
SPR\_PICSR, 307  
SPR\_PICSR\_IS, 307  
SPR\_PMR, 307  
SPR\_PMR\_DCGE, 307  
SPR\_PMR\_DME, 307  
SPR\_PMR\_SDF, 307  
SPR\_PMR\_SME, 307  
SPR\_PMR\_SUME, 307  
SPR\_PPC, 307  
SPR\_SR, 307  
SPR\_SR\_CE, 307  
SPR\_SR\_CID, 307

- SPR\_SR\_CY, 307
- SPR\_SR\_DCE, 307
- SPR\_SR\_DME, 307
- SPR\_SR\_DSX, 307
- SPR\_SR\_EPH, 307
- SPR\_SR\_F, 307
- SPR\_SR\_FO, 307
- SPR\_SR\_ICE, 307
- SPR\_SR\_IEE, 307
- SPR\_SR\_IME, 307
- SPR\_SR\_LEE, 307
- SPR\_SR\_OV, 307
- SPR\_SR\_OVE, 307
- SPR\_SR\_RES, 307
- SPR\_SR\_SM, 307
- SPR\_SR\_SUMRA, 307
- SPR\_SR\_TEE, 307
- SPR\_TTCR, 307
- SPR\_TTCR\_PERIOD, 307
- SPR\_TTMR, 307
- SPR\_TTMR\_CR, 307
- SPR\_TTMR\_IE, 307
- SPR\_TTMR\_IP, 307
- SPR\_TTMR\_M, 307
- SPR\_TTMR\_PERIOD, 307
- SPR\_TTMR\_RT, 307
- SPR\_TTMR\_SR, 307
- SPR\_UPR, 307
- SPR\_UPR\_CUP, 307
- SPR\_UPR\_DCP, 307
- SPR\_UPR\_DMP, 307
- SPR\_UPR\_DUP, 307
- SPR\_UPR\_ICP, 307
- SPR\_UPR\_IMP, 307
- SPR\_UPR\_MP, 307
- SPR\_UPR\_PCUP, 307
- SPR\_UPR\_PICP, 307
- SPR\_UPR\_PMP, 307
- SPR\_UPR\_RES, 307
- SPR\_UPR\_TTP, 307
- SPR\_UPR\_UP, 307
- SPR\_VR, 307
- SPR\_VR\_CFG, 307
- SPR\_VR\_CFG\_OFF, 307
- SPR\_VR\_RES, 307
- SPR\_VR\_REV, 307
- SPR\_VR\_REV\_OFF, 307
- SPR\_VR\_VER, 307
- SPR\_VR\_VER\_OFF, 307
- SPRGROUP\_D, 307
- SPRGROUP\_DC, 307
- SPRGROUP\_DMMU, 307
- SPRGROUP\_IC, 307
- SPRGROUP\_IMMU, 307
- SPRGROUP\_MAC, 307
- SPRGROUP\_PC, 307
- SPRGROUP\_PIC, 307
- SPRGROUP\_PM, 307
- SPRGROUP\_SYS, 307
- SPRGROUP\_TT, 307
- spr-dump.c
  - dump\_spr, 309
  - ret\_spr, 309
  - spr\_cpucfgr, 309
  - spr\_d\_group, 309
  - spr\_dc\_group, 310
  - spr\_dccfgr, 310
  - spr\_dccr, 310
  - spr\_dcfgr, 310
  - spr\_dmmu\_group, 311
  - spr\_dmmucfgr, 311
  - spr\_dmmucr, 311
  - spr\_dmr1, 311
  - spr\_dmr2, 312
  - spr\_drr, 312
  - spr\_dsr, 312
  - spr\_dtlbmr, 313
  - spr\_dtlbtr, 313
  - spr\_dwcr, 313
  - spr\_groups, 313
  - spr\_ic\_group, 314
  - spr\_iccfgr, 314
  - spr\_iccr, 314
  - spr\_immu\_group, 314
  - spr\_immucfgr, 315
  - spr\_immucr, 315
  - spr\_itlbmr, 315
  - spr\_itlbtr, 315
  - spr\_mac\_group, 316
  - spr\_one\_val, 316
  - spr\_pc\_group, 316
  - spr\_pcmr, 316
  - spr\_pic\_group, 317
  - spr\_picmr, 317
  - spr\_pm\_group, 317
  - spr\_pmr, 317
  - spr\_sr, 317
  - spr\_sys\_group, 318
  - spr\_tt\_group, 318
  - spr\_ttmr, 318
  - spr\_upr, 319
  - spr\_vr, 319
- spr-dump.h
  - dump\_spr, 320
- spr\_bit\_def, 172
  - mask, 172
  - name, 172
- SPR\_CPUCFGR

- spr-defs.h, 307
- spr\_cpucfgr
  - spr-dump.c, 309
- SPR\_CPUCFGR\_CGF
  - spr-defs.h, 307
- SPR\_CPUCFGR\_NSGF
  - spr-defs.h, 307
- SPR\_CPUCFGR\_OB32S
  - spr-defs.h, 307
- SPR\_CPUCFGR\_OB64S
  - spr-defs.h, 307
- SPR\_CPUCFGR\_OF32S
  - spr-defs.h, 307
- SPR\_CPUCFGR\_OF64S
  - spr-defs.h, 307
- SPR\_CPUCFGR\_OV64S
  - spr-defs.h, 307
- SPR\_CPUCFGR\_RES
  - spr-defs.h, 307
- spr\_d\_group
  - spr-dump.c, 309
- spr\_dc\_group
  - spr-dump.c, 310
- SPR\_DCBFR
  - spr-defs.h, 307
- SPR\_DCBIR
  - spr-defs.h, 307
- SPR\_DCBLR
  - spr-defs.h, 307
- SPR\_DCBPR
  - spr-defs.h, 307
- SPR\_DCBWR
  - spr-defs.h, 307
- SPR\_DCCFGR
  - spr-defs.h, 307
- spr\_dccfgr
  - spr-dump.c, 310
- SPR\_DCCFGR\_CBFRI
  - spr-defs.h, 307
- SPR\_DCCFGR\_CBIRI
  - spr-defs.h, 307
- SPR\_DCCFGR\_CBLRI
  - spr-defs.h, 307
- SPR\_DCCFGR\_CBPRI
  - spr-defs.h, 307
- SPR\_DCCFGR\_CBS
  - spr-defs.h, 307
- SPR\_DCCFGR\_CBS\_OFF
  - spr-defs.h, 307
- SPR\_DCCFGR\_CBWBRI
  - spr-defs.h, 307
- SPR\_DCCFGR\_CCRI
  - spr-defs.h, 307
- SPR\_DCCFGR\_CWS
  - spr-defs.h, 307
- SPR\_DCCFGR\_NCS
  - spr-defs.h, 307
- SPR\_DCCFGR\_NCS\_OFF
  - spr-defs.h, 307
- SPR\_DCCFGR\_NCW
  - spr-defs.h, 307
- SPR\_DCCFGR\_NCW\_OFF
  - spr-defs.h, 307
- SPR\_DCCR
  - spr-defs.h, 307
- spr\_dccr
  - spr-dump.c, 310
- SPR\_DCCR\_EW
  - spr-defs.h, 307
- SPR\_DCFGR
  - spr-defs.h, 307
- spr\_dcfgr
  - spr-dump.c, 310
- SPR\_DCFGR\_NDP
  - spr-defs.h, 307
- SPR\_DCFGR\_NDP1
  - spr-defs.h, 307
- SPR\_DCFGR\_NDP2
  - spr-defs.h, 307
- SPR\_DCFGR\_NDP3
  - spr-defs.h, 307
- SPR\_DCFGR\_NDP4
  - spr-defs.h, 307
- SPR\_DCFGR\_NDP5
  - spr-defs.h, 307
- SPR\_DCFGR\_NDP6
  - spr-defs.h, 307
- SPR\_DCFGR\_NDP7
  - spr-defs.h, 307
- SPR\_DCFGR\_NDP8
  - spr-defs.h, 307
- SPR\_DCFGR\_WPCI
  - spr-defs.h, 307
- SPR\_DCR
  - spr-defs.h, 307
- SPR\_DCR\_BASE
  - spr-defs.h, 307
- SPR\_DCR\_CC
  - spr-defs.h, 307
- SPR\_DCR\_CC\_EQUAL
  - spr-defs.h, 307
- SPR\_DCR\_CC\_GREAT
  - spr-defs.h, 307
- SPR\_DCR\_CC\_GREATER
  - spr-defs.h, 307
- SPR\_DCR\_CC\_LESS
  - spr-defs.h, 307
- SPR\_DCR\_CC\_LESSE
  - spr-defs.h, 307

- spr-defs.h, 307
- SPR\_DCR\_CC\_MASKED
  - spr-defs.h, 307
- SPR\_DCR\_CC\_NEQUAL
  - spr-defs.h, 307
- SPR\_DCR\_CT
  - spr-defs.h, 307
- SPR\_DCR\_CT\_DISABLED
  - spr-defs.h, 307
- SPR\_DCR\_CT\_IFEA
  - spr-defs.h, 307
- SPR\_DCR\_CT\_LD
  - spr-defs.h, 307
- SPR\_DCR\_CT\_LEA
  - spr-defs.h, 307
- SPR\_DCR\_CT\_LSD
  - spr-defs.h, 307
- SPR\_DCR\_CT\_LSEA
  - spr-defs.h, 307
- SPR\_DCR\_CT\_SD
  - spr-defs.h, 307
- SPR\_DCR\_CT\_SEA
  - spr-defs.h, 307
- SPR\_DCR\_DP
  - spr-defs.h, 307
- SPR\_DCR\_LAST
  - spr-defs.h, 307
- SPR\_DCR\_SC
  - spr-defs.h, 307
- spr\_def, 173
  - bits, 173
  - from\_spr, 173
  - name, 173
  - to\_spr, 173
- spr\_dmmu\_group
  - spr-dump.c, 311
- SPR\_DMMUCFGR
  - spr-defs.h, 307
- spr\_dmmucfgr
  - spr-dump.c, 311
- SPR\_DMMUCFGR\_CRI
  - spr-defs.h, 307
- SPR\_DMMUCFGR\_HTR
  - spr-defs.h, 307
- SPR\_DMMUCFGR\_NAE
  - spr-defs.h, 307
- SPR\_DMMUCFGR\_NTS
  - spr-defs.h, 307
- SPR\_DMMUCFGR\_NTS\_OFF
  - spr-defs.h, 307
- SPR\_DMMUCFGR\_NTW
  - spr-defs.h, 307
- SPR\_DMMUCFGR\_NTW\_OFF
  - spr-defs.h, 307
- SPR\_DMMUCFGR\_PRI
  - spr-defs.h, 307
- SPR\_DMMUCFGR\_TEIRI
  - spr-defs.h, 307
- SPR\_DMMUCR
  - spr-defs.h, 307
- spr\_dmmucr
  - spr-dump.c, 311
- SPR\_DMMUCR\_P1S
  - spr-defs.h, 307
- SPR\_DMMUCR\_P2S
  - spr-defs.h, 307
- SPR\_DMMUCR\_PADDR\_WIDTH
  - spr-defs.h, 307
- SPR\_DMMUCR\_VADDR\_WIDTH
  - spr-defs.h, 307
- SPR\_DMR1
  - spr-defs.h, 307
- spr\_dmr1
  - spr-dump.c, 311
- SPR\_DMR1\_BT
  - spr-defs.h, 307
- SPR\_DMR1\_CW
  - spr-defs.h, 307
- SPR\_DMR1\_CW0
  - spr-defs.h, 307
- SPR\_DMR1\_CW0\_AND
  - spr-defs.h, 307
- SPR\_DMR1\_CW0\_OR
  - spr-defs.h, 307
- SPR\_DMR1\_CW1
  - spr-defs.h, 307
- SPR\_DMR1\_CW1\_AND
  - spr-defs.h, 307
- SPR\_DMR1\_CW1\_OR
  - spr-defs.h, 307
- SPR\_DMR1\_CW2
  - spr-defs.h, 307
- SPR\_DMR1\_CW2\_AND
  - spr-defs.h, 307
- SPR\_DMR1\_CW2\_OR
  - spr-defs.h, 307
- SPR\_DMR1\_CW3
  - spr-defs.h, 307
- SPR\_DMR1\_CW3\_AND
  - spr-defs.h, 307
- SPR\_DMR1\_CW3\_OR
  - spr-defs.h, 307
- SPR\_DMR1\_CW4
  - spr-defs.h, 307
- SPR\_DMR1\_CW4\_AND
  - spr-defs.h, 307
- SPR\_DMR1\_CW4\_OR
  - spr-defs.h, 307

- SPR\_DMR1\_CW5
  - spr-defs.h, [307](#)
- SPR\_DMR1\_CW5\_AND
  - spr-defs.h, [307](#)
- SPR\_DMR1\_CW5\_OR
  - spr-defs.h, [307](#)
- SPR\_DMR1\_CW6
  - spr-defs.h, [307](#)
- SPR\_DMR1\_CW6\_AND
  - spr-defs.h, [307](#)
- SPR\_DMR1\_CW6\_OR
  - spr-defs.h, [307](#)
- SPR\_DMR1\_CW7
  - spr-defs.h, [307](#)
- SPR\_DMR1\_CW7\_AND
  - spr-defs.h, [307](#)
- SPR\_DMR1\_CW7\_OR
  - spr-defs.h, [307](#)
- SPR\_DMR1\_CW8
  - spr-defs.h, [307](#)
- SPR\_DMR1\_CW8\_AND
  - spr-defs.h, [307](#)
- SPR\_DMR1\_CW8\_OR
  - spr-defs.h, [307](#)
- SPR\_DMR1\_CW9
  - spr-defs.h, [307](#)
- SPR\_DMR1\_CW9\_AND
  - spr-defs.h, [307](#)
- SPR\_DMR1\_CW9\_OR
  - spr-defs.h, [307](#)
- SPR\_DMR1\_RES1
  - spr-defs.h, [307](#)
- SPR\_DMR1\_RES2
  - spr-defs.h, [307](#)
- SPR\_DMR1\_ST
  - spr-defs.h, [307](#)
- SPR\_DMR2
  - spr-defs.h, [307](#)
- spr\_dmr2
  - spr-dump.c, [312](#)
- SPR\_DMR2\_AWTC
  - spr-defs.h, [307](#)
- SPR\_DMR2\_AWTC\_OFF
  - spr-defs.h, [307](#)
- SPR\_DMR2\_WBS
  - spr-defs.h, [307](#)
- SPR\_DMR2\_WBS\_OFF
  - spr-defs.h, [307](#)
- SPR\_DMR2\_WCE0
  - spr-defs.h, [307](#)
- SPR\_DMR2\_WCE1
  - spr-defs.h, [307](#)
- SPR\_DMR2\_WGB
  - spr-defs.h, [307](#)
- SPR\_DMR2\_WGB\_OFF
  - spr-defs.h, [307](#)
- SPR\_DRR
  - spr-defs.h, [307](#)
- spr\_drr
  - spr-dump.c, [312](#)
- SPR\_DRR\_AE
  - spr-defs.h, [307](#)
- SPR\_DRR\_BUSEE
  - spr-defs.h, [307](#)
- SPR\_DRR\_DME
  - spr-defs.h, [307](#)
- SPR\_DRR\_DPFE
  - spr-defs.h, [307](#)
- SPR\_DRR\_FPE
  - spr-defs.h, [307](#)
- SPR\_DRR\_IE
  - spr-defs.h, [307](#)
- SPR\_DRR\_IIE
  - spr-defs.h, [307](#)
- SPR\_DRR\_IME
  - spr-defs.h, [307](#)
- SPR\_DRR\_IPFE
  - spr-defs.h, [307](#)
- SPR\_DRR\_RE
  - spr-defs.h, [307](#)
- SPR\_DRR\_RSTE
  - spr-defs.h, [307](#)
- SPR\_DRR\_SCE
  - spr-defs.h, [307](#)
- SPR\_DRR\_TE
  - spr-defs.h, [307](#)
- SPR\_DRR\_TTE
  - spr-defs.h, [307](#)
- SPR\_DSR
  - spr-defs.h, [307](#)
- spr\_dsr
  - spr-dump.c, [312](#)
- SPR\_DSR\_AE
  - spr-defs.h, [307](#)
- SPR\_DSR\_BUSEE
  - spr-defs.h, [307](#)
- SPR\_DSR\_DME
  - spr-defs.h, [307](#)
- SPR\_DSR\_DPFE
  - spr-defs.h, [307](#)
- SPR\_DSR\_FPE
  - spr-defs.h, [307](#)
- SPR\_DSR\_IE
  - spr-defs.h, [307](#)
- SPR\_DSR\_IIE
  - spr-defs.h, [307](#)
- SPR\_DSR\_IME
  - spr-defs.h, [307](#)

- SPR\_DSR\_IPFE  
spr-defs.h, 307
- SPR\_DSR\_RE  
spr-defs.h, 307
- SPR\_DSR\_RSTE  
spr-defs.h, 307
- SPR\_DSR\_SCE  
spr-defs.h, 307
- SPR\_DSR\_TE  
spr-defs.h, 307
- SPR\_DSR\_TTE  
spr-defs.h, 307
- spr\_dtlbmr  
spr-dump.c, 313
- SPR\_DTLBMR\_BASE  
spr-defs.h, 307
- SPR\_DTLBMR\_CID  
spr-defs.h, 307
- SPR\_DTLBMR\_LAST  
spr-defs.h, 307
- SPR\_DTLBMR\_LRU  
spr-defs.h, 307
- SPR\_DTLBMR\_PL1  
spr-defs.h, 307
- SPR\_DTLBMR\_V  
spr-defs.h, 307
- SPR\_DTLBMR\_VPN  
spr-defs.h, 307
- spr\_dtlbtr  
spr-dump.c, 313
- SPR\_DTLBTR\_A  
spr-defs.h, 307
- SPR\_DTLBTR\_BASE  
spr-defs.h, 307
- SPR\_DTLBTR\_CC  
spr-defs.h, 307
- SPR\_DTLBTR\_CI  
spr-defs.h, 307
- SPR\_DTLBTR\_D  
spr-defs.h, 307
- SPR\_DTLBTR\_LAST  
spr-defs.h, 307
- SPR\_DTLBTR\_PPN  
spr-defs.h, 307
- SPR\_DTLBTR\_SRE  
spr-defs.h, 307
- SPR\_DTLBTR\_SWE  
spr-defs.h, 307
- SPR\_DTLBTR\_URE  
spr-defs.h, 307
- SPR\_DTLBTR\_UWE  
spr-defs.h, 307
- SPR\_DTLBTR\_WBC  
spr-defs.h, 307
- SPR\_DTLBTR\_WOM  
spr-defs.h, 307
- SPR\_DVR  
spr-defs.h, 307
- spr\_dwcr  
spr-dump.c, 313
- SPR\_DWCRO  
spr-defs.h, 307
- SPR\_DWCRI  
spr-defs.h, 307
- SPR\_DWCR\_COUNT  
spr-defs.h, 307
- SPR\_DWCR\_MATCH  
spr-defs.h, 307
- SPR\_DWCR\_MATCH\_OFF  
spr-defs.h, 307
- SPR\_EEAR\_BASE  
spr-defs.h, 307
- SPR\_EEAR\_LAST  
spr-defs.h, 307
- SPR\_EPCCR\_BASE  
spr-defs.h, 307
- SPR\_EPCCR\_LAST  
spr-defs.h, 307
- SPR\_ESR\_BASE  
spr-defs.h, 307
- SPR\_ESR\_LAST  
spr-defs.h, 307
- spr\_groups  
spr-dump.c, 313
- spr\_ic\_group  
spr-dump.c, 314
- SPR\_ICBIR  
spr-defs.h, 307
- SPR\_ICBLR  
spr-defs.h, 307
- SPR\_ICBPR  
spr-defs.h, 307
- SPR\_ICCFGR  
spr-defs.h, 307
- spr\_iccfgr  
spr-dump.c, 314
- SPR\_ICCFGR\_CBIRI  
spr-defs.h, 307
- SPR\_ICCFGR\_CBLRI  
spr-defs.h, 307
- SPR\_ICCFGR\_CBPRI  
spr-defs.h, 307
- SPR\_ICCFGR\_CBS  
spr-defs.h, 307
- SPR\_ICCFGR\_CBS\_OFF  
spr-defs.h, 307
- SPR\_ICCFGR\_CCRI  
spr-defs.h, 307

- SPR\_ICCFGR\_NCS
  - spr-defs.h, 307
- SPR\_ICCFGR\_NCS\_OFF
  - spr-defs.h, 307
- SPR\_ICCFGR\_NCW
  - spr-defs.h, 307
- SPR\_ICCFGR\_NCW\_OFF
  - spr-defs.h, 307
- SPR\_ICCR
  - spr-defs.h, 307
- spr\_iccr
  - spr-dump.c, 314
- SPR\_ICCR\_EW
  - spr-defs.h, 307
- SPR\_ICR\_BASE
  - spr-defs.h, 307
- SPR\_ICR\_LAST
  - spr-defs.h, 307
- spr\_immu\_group
  - spr-dump.c, 314
- SPR\_IMMUCFGR
  - spr-defs.h, 307
- spr\_immucfgr
  - spr-dump.c, 315
- SPR\_IMMUCFGR\_CRI
  - spr-defs.h, 307
- SPR\_IMMUCFGR\_HTR
  - spr-defs.h, 307
- SPR\_IMMUCFGR\_NAE
  - spr-defs.h, 307
- SPR\_IMMUCFGR\_NTS
  - spr-defs.h, 307
- SPR\_IMMUCFGR\_NTS\_OFF
  - spr-defs.h, 307
- SPR\_IMMUCFGR\_NTW
  - spr-defs.h, 307
- SPR\_IMMUCFGR\_NTW\_OFF
  - spr-defs.h, 307
- SPR\_IMMUCFGR\_PRI
  - spr-defs.h, 307
- SPR\_IMMUCFGR\_TEIRI
  - spr-defs.h, 307
- SPR\_IMMUCR
  - spr-defs.h, 307
- spr\_immucr
  - spr-dump.c, 315
- SPR\_IMMUCR\_P1S
  - spr-defs.h, 307
- SPR\_IMMUCR\_P2S
  - spr-defs.h, 307
- SPR\_IMMUCR\_PADDR\_WIDTH
  - spr-defs.h, 307
- SPR\_IMMUCR\_VADDR\_WIDTH
  - spr-defs.h, 307
- spr\_itlbmr
  - spr-dump.c, 315
- SPR\_ITLBMR\_BASE
  - spr-defs.h, 307
- SPR\_ITLBMR\_CID
  - spr-defs.h, 307
- SPR\_ITLBMR\_LAST
  - spr-defs.h, 307
- SPR\_ITLBMR\_LRU
  - spr-defs.h, 307
- SPR\_ITLBMR\_PL1
  - spr-defs.h, 307
- SPR\_ITLBMR\_V
  - spr-defs.h, 307
- SPR\_ITLBMR\_VPN
  - spr-defs.h, 307
- spr\_itlbtr
  - spr-dump.c, 315
- SPR\_ITLBTR\_A
  - spr-defs.h, 307
- SPR\_ITLBTR\_BASE
  - spr-defs.h, 307
- SPR\_ITLBTR\_CC
  - spr-defs.h, 307
- SPR\_ITLBTR\_CI
  - spr-defs.h, 307
- SPR\_ITLBTR\_D
  - spr-defs.h, 307
- SPR\_ITLBTR\_LAST
  - spr-defs.h, 307
- SPR\_ITLBTR\_PPN
  - spr-defs.h, 307
- SPR\_ITLBTR\_SXE
  - spr-defs.h, 307
- SPR\_ITLBTR\_UXE
  - spr-defs.h, 307
- SPR\_ITLBTR\_WBC
  - spr-defs.h, 307
- SPR\_ITLBTR\_WOM
  - spr-defs.h, 307
- spr\_mac\_group
  - spr-dump.c, 316
- SPR\_MACHI
  - spr-defs.h, 307
- SPR\_MACLO
  - spr-defs.h, 307
- SPR\_NPC
  - spr-defs.h, 307
- spr\_one\_val
  - spr-dump.c, 316
- spr\_pc\_group
  - spr-dump.c, 316
- SPR\_PCCFGR
  - spr-defs.h, 307

- SPR\_PCCR
  - spr-defs.h, 307
- SPR\_PCMR
  - spr-defs.h, 307
- spr\_pcmr
  - spr-dump.c, 316
- SPR\_PCMR\_BS
  - spr-defs.h, 307
- SPR\_PCMR\_CISM
  - spr-defs.h, 307
- SPR\_PCMR\_CIUM
  - spr-defs.h, 307
- SPR\_PCMR\_CP
  - spr-defs.h, 307
- SPR\_PCMR\_DCM
  - spr-defs.h, 307
- SPR\_PCMR\_DDS
  - spr-defs.h, 307
- SPR\_PCMR\_DTLBM
  - spr-defs.h, 307
- SPR\_PCMR\_ICM
  - spr-defs.h, 307
- SPR\_PCMR\_IF
  - spr-defs.h, 307
- SPR\_PCMR\_IFS
  - spr-defs.h, 307
- SPR\_PCMR\_ITLBM
  - spr-defs.h, 307
- SPR\_PCMR\_LA
  - spr-defs.h, 307
- SPR\_PCMR\_LSUS
  - spr-defs.h, 307
- SPR\_PCMR\_SA
  - spr-defs.h, 307
- SPR\_PCMR\_UMRA
  - spr-defs.h, 307
- SPR\_PCMR\_WPE
  - spr-defs.h, 307
- spr\_pic\_group
  - spr-dump.c, 317
- SPR\_PICMR
  - spr-defs.h, 307
- spr\_picmr
  - spr-dump.c, 317
- SPR\_PICMR\_IUM
  - spr-defs.h, 307
- SPR\_PICPR
  - spr-defs.h, 307
- SPR\_PICPR\_IPRIO
  - spr-defs.h, 307
- SPR\_PICSR
  - spr-defs.h, 307
- SPR\_PICSR\_IS
  - spr-defs.h, 307
- spr\_pm\_group
  - spr-dump.c, 317
- SPR\_PMR
  - spr-defs.h, 307
- spr\_pmr
  - spr-dump.c, 317
- SPR\_PMR\_DCGE
  - spr-defs.h, 307
- SPR\_PMR\_DME
  - spr-defs.h, 307
- SPR\_PMR\_SDF
  - spr-defs.h, 307
- SPR\_PMR\_SME
  - spr-defs.h, 307
- SPR\_PMR\_SUME
  - spr-defs.h, 307
- SPR\_PPC
  - spr-defs.h, 307
- spr\_read\_ttcrr
  - tick.c, 843
  - tick.h, 846
- SPR\_SR
  - spr-defs.h, 307
- spr\_sr
  - spr-dump.c, 317
- SPR\_SR\_CE
  - spr-defs.h, 307
- SPR\_SR\_CID
  - spr-defs.h, 307
- SPR\_SR\_CY
  - spr-defs.h, 307
- SPR\_SR\_DCE
  - spr-defs.h, 307
- SPR\_SR\_DME
  - spr-defs.h, 307
- SPR\_SR\_DSX
  - spr-defs.h, 307
- SPR\_SR\_EPH
  - spr-defs.h, 307
- SPR\_SR\_F
  - spr-defs.h, 307
- SPR\_SR\_FO
  - spr-defs.h, 307
- SPR\_SR\_ICE
  - spr-defs.h, 307
- SPR\_SR\_IEE
  - spr-defs.h, 307
- SPR\_SR\_IME
  - spr-defs.h, 307
- SPR\_SR\_LEE
  - spr-defs.h, 307
- SPR\_SR\_OV
  - spr-defs.h, 307
- SPR\_SR\_OVE



- spr-defs.h, 307
- SPR\_SR\_RES
  - spr-defs.h, 307
- SPR\_SR\_SM
  - spr-defs.h, 307
- SPR\_SR\_SUMRA
  - spr-defs.h, 307
- SPR\_SR\_TEE
  - spr-defs.h, 307
- spr\_sys\_group
  - spr-dump.c, 318
- spr\_tt\_group
  - spr-dump.c, 318
- SPR\_TTCR
  - spr-defs.h, 307
- SPR\_TTCR\_PERIOD
  - spr-defs.h, 307
- SPR\_TTMR
  - spr-defs.h, 307
- spr\_ttmr
  - spr-dump.c, 318
- SPR\_TTMR\_CR
  - spr-defs.h, 307
- SPR\_TTMR\_IE
  - spr-defs.h, 307
- SPR\_TTMR\_IP
  - spr-defs.h, 307
- SPR\_TTMR\_M
  - spr-defs.h, 307
- SPR\_TTMR\_PERIOD
  - spr-defs.h, 307
- SPR\_TTMR\_RT
  - spr-defs.h, 307
- SPR\_TTMR\_SR
  - spr-defs.h, 307
- SPR\_UPR
  - spr-defs.h, 307
- spr\_upr
  - spr-dump.c, 319
- SPR\_UPR\_CUP
  - spr-defs.h, 307
- SPR\_UPR\_DCP
  - spr-defs.h, 307
- SPR\_UPR\_DMP
  - spr-defs.h, 307
- SPR\_UPR\_DUP
  - spr-defs.h, 307
- SPR\_UPR\_ICP
  - spr-defs.h, 307
- SPR\_UPR\_IMP
  - spr-defs.h, 307
- SPR\_UPR\_MP
  - spr-defs.h, 307
- SPR\_UPR\_PCUP
  - spr-defs.h, 307
- SPR\_UPR\_PICP
  - spr-defs.h, 307
- SPR\_UPR\_PMP
  - spr-defs.h, 307
- SPR\_UPR\_RES
  - spr-defs.h, 307
- SPR\_UPR\_TTP
  - spr-defs.h, 307
- SPR\_UPR\_UP
  - spr-defs.h, 307
- SPR\_VR
  - spr-defs.h, 307
- spr\_vr
  - spr-dump.c, 319
- SPR\_VR\_CFG
  - spr-defs.h, 307
- SPR\_VR\_CFG\_OFF
  - spr-defs.h, 307
- SPR\_VR\_RES
  - spr-defs.h, 307
- SPR\_VR\_REV
  - spr-defs.h, 307
- SPR\_VR\_REV\_OFF
  - spr-defs.h, 307
- SPR\_VR\_VER
  - spr-defs.h, 307
- SPR\_VR\_VER\_OFF
  - spr-defs.h, 307
- spr\_write\_ttc
  - tick.c, 843
  - tick.h, 846
- spr\_write\_ttmr
  - tick.c, 843
  - tick.h, 847
- SPRGROUP\_D
  - spr-defs.h, 307
- SPRGROUP\_DC
  - spr-defs.h, 307
- SPRGROUP\_DMMU
  - spr-defs.h, 307
- SPRGROUP\_IC
  - spr-defs.h, 307
- SPRGROUP\_IMMU
  - spr-defs.h, 307
- SPRGROUP\_MAC
  - spr-defs.h, 307
- SPRGROUP\_PC
  - spr-defs.h, 307
- SPRGROUP\_PIC
  - spr-defs.h, 307
- SPRGROUP\_PM
  - spr-defs.h, 307
- SPRGROUP\_SYS

- spr-defs.h, 307
- SPRGROUP\_TT
  - spr-defs.h, 307
- sprs
  - cpu\_state, 61
- sprs.c
  - audio\_cnt, 322
  - DECLARE\_DEBUG\_CHANNEL, 322
  - fo, 322
  - mfspr, 322
  - mtspr, 322
  - sprs\_status, 322
- sprs.h
  - dump\_spr, 323
  - mfspr, 323
  - mtspr, 324
  - sprs\_status, 324
- sprs\_status
  - sprs.c, 322
  - sprs.h, 324
- SR\_REGNUM
  - rsp-server.c, 540
- sstats
  - stats.c, 283
- sstats\_entry, 174
  - cnt\_dynamic, 174
  - insn, 174
- SSTATS\_LEN
  - stats.c, 281
- st\_info
  - elf32\_sym, 98
  - elf64\_sym, 107
- st\_name
  - elf32\_sym, 98
  - elf64\_sym, 107
- st\_other
  - elf32\_sym, 98
  - elf64\_sym, 107
- st\_shndx
  - elf32\_sym, 98
  - elf64\_sym, 107
- st\_size
  - elf32\_sym, 98
  - elf64\_sym, 107
- st\_value
  - elf32\_sym, 98
  - elf64\_sym, 107
- stack
  - profiler.c, 782
- STACK\_ARGS
  - simprintf.c, 840
- STACK\_SIZE
  - abstract.h, 231
- stack\_struct, 175
  - addr, 175
  - cycles, 175
  - name, 175
  - raddr, 175
- stalled
  - runtime, 165
- STANDBY
  - atacmd.h, 627
- STANDBY\_IMMEDIATE
  - atacmd.h, 627
- start\_addr
  - \_cuc\_func, 16
  - mprofiler.c, 591
  - rsp-server.c, 560
- stat
  - ata\_host, 26
  - vga\_state, 180
- stat\_func
  - sim\_stat, 171
- state
  - ata\_device, 22
  - eth\_device, 113
- stats.c
  - addstats, 281
  - addfstats, 281
  - addsstats, 281
  - dc\_stats, 282
  - dmmu\_stats, 282
  - dstats, 282
  - DSTATS\_LEN, 281
  - fstats, 282
  - FSTATS\_LEN, 281
  - func\_unit\_str, 282
  - ic\_stats, 282
  - immu\_stats, 282
  - initstats, 281
  - or1k\_mstats, 282
  - printotherstats, 281
  - printstats, 281
  - raw\_stats, 283
  - SD, 281
  - sstats, 283
  - SSTATS\_LEN, 281
- stats.h
  - addstats, 285
  - addfstats, 285
  - addsstats, 285
  - dc\_stats, 285
  - dmmu\_stats, 285
  - ic\_stats, 285
  - immu\_stats, 285
  - initstats, 285
  - or1k\_mstats, 285
  - printstats, 285

- RAW\_RANGE, 285
- raw\_stats, 285
- status
  - ata\_device, 22
  - channel\_ops, 39
  - jtr\_chain\_response, 134
  - jtr\_failure\_response, 135
  - jtr\_read\_block\_response, 137
  - jtr\_read\_response, 139
  - jtr\_write\_block\_response, 141
  - jtr\_write\_response, 143
- STB\_GLOBAL
  - elf.h, 260
- STB\_LOCAL
  - elf.h, 260
- STB\_WEAK
  - elf.h, 260
- store\_hitdelay
  - config, 55
- store\_missdelay
  - config, 55
- storecycles
  - runtime, 165
- stores\_pagefaults
  - dmmustats\_entry, 87
- stores\_tlbhit
  - dmmustats\_entry, 87
- stores\_tlbmiss
  - dmmustats\_entry, 87
- STR\_SIZE
  - sim-config.h, 813
- str\_val
  - param\_val, 159
- stream
  - ata\_device, 22
- strict\_npc
  - config, 55
- strip\_space
  - sim-cmd.c, 800
- strndup
  - port.h, 778
  - strndup.c, 779
- strndup.c
  - strndup, 779
- rstrip
  - parse.c, 276
  - parse.h, 279
- STT\_FILE
  - elf.h, 260
- STT\_FUNC
  - elf.h, 260
- STT\_NOTYPE
  - elf.h, 260
- STT\_OBJECT
  - elf.h, 260
- STT\_SECTION
  - elf.h, 260
- supercycles
  - runtime, 165
- superscalar
  - config, 55
- support/dbchs.h, 818
- support/debug.c, 819
- support/debug.h, 821
- support/dumpverilog.c, 825
- support/dumpverilog.h, 828
- support/misc.c, 830
- support/misc.h, 831
- support/profile.c, 832
- support/profile.h, 833
- support/sched.c, 835
- support/sched.h, 837
- support/simprintf.c, 839
- support/simprintf.h, 841
- SUPPORT\_APM
  - atadevice-cmdi.h, 636
- SUPPORT\_CFA
  - atadevice-cmdi.h, 636
- SUPPORT\_DEVICE\_RESET\_CMD
  - atadevice-cmdi.h, 636
- SUPPORT\_DOWNLOAD\_MICROCODE
  - atadevice-cmdi.h, 636
- SUPPORT\_HOST\_PROTECTED\_AREA
  - atadevice-cmdi.h, 636
- SUPPORT\_LOOKAHEAD
  - atadevice-cmdi.h, 636
- SUPPORT\_NOP\_CMD
  - atadevice-cmdi.h, 636
- SUPPORT\_POWER\_MANAGEMENT
  - atadevice-cmdi.h, 636
- SUPPORT\_POWER\_UP\_IN\_STANDBY\_MODE
  - atadevice-cmdi.h, 636
- SUPPORT\_READ\_BUFFER\_CMD
  - atadevice-cmdi.h, 636
- SUPPORT\_READ\_WRITE\_DMA\_QUEUED
  - atadevice-cmdi.h, 636
- SUPPORT\_RELEASE\_INTERRUPT
  - atadevice-cmdi.h, 636
- SUPPORT\_REMOVABLE\_MEDIA
  - atadevice-cmdi.h, 636
- SUPPORT\_REMOVABLE\_MEDIA\_-
  - NOTIFICATION
  - atadevice-cmdi.h, 636
- SUPPORT\_SECURITY\_MODE
  - atadevice-cmdi.h, 636
- SUPPORT\_SERVICE\_INTERRUPT
  - atadevice-cmdi.h, 636
- SUPPORT\_SET\_MAX

- atadevice-cmdi.h, 636
- SUPPORT\_SMART
  - atadevice-cmdi.h, 636
- SUPPORT\_WRITE\_BUFFER\_CMD
  - atadevice-cmdi.h, 636
- SUPPORT\_WRITE\_CACHE
  - atadevice-cmdi.h, 636
- SWAP\_ENDIAN\_LONG
  - coeff.h, 250
- SWAP\_ENDIAN\_SHORT
  - coeff.h, 250
- switch\_param
  - sim-config.c, 811
- swptr
  - dma\_channel, 81
- sz
  - dma\_channel, 81
- T
  - op-1t.h, 394
  - op-2t.h, 396
  - op-3t.h, 398
- T0\_REG
  - i386-regs.h, 380
- T1\_REG
  - i386-regs.h, 380
- T2\_REG
  - i386-regs.h, 380
- T\_NONE
  - dyn-rec.c, 335
- tagaddr
  - dc\_set, 70
- tagaddr\_mask
  - ic, 127
- tags
  - ic, 127
- taken
  - bpb\_entry, 30
  - branchstat, 32
- TARGET\_SIGNAL\_ALRM
  - rsp-server.c, 541
- TARGET\_SIGNAL\_BUS
  - rsp-server.c, 541
- TARGET\_SIGNAL\_FPE
  - rsp-server.c, 541
- TARGET\_SIGNAL\_ILL
  - rsp-server.c, 541
- TARGET\_SIGNAL\_INT
  - rsp-server.c, 541
- TARGET\_SIGNAL\_NONE
  - rsp-server.c, 541
- TARGET\_SIGNAL\_PWR
  - rsp-server.c, 541
- TARGET\_SIGNAL\_SEGV
  - rsp-server.c, 541
- TARGET\_SIGNAL\_TRAP
  - rsp-server.c, 541
- TARGET\_SIGNAL\_USR2
  - rsp-server.c, 541
- target\_signal
  - rsp-server.c, 540
- tcp.c
  - tcp\_channel\_ops, 673
  - tcp\_init, 673
  - tcp\_open, 673
  - tcp\_read, 673
  - tcp\_write, 673
  - wait\_for\_tcp\_connect, 673
- tcp.h
  - tcp\_channel\_ops, 674
- tcp\_channel, 176
  - connected, 176
  - fds, 176
  - nonblocking, 176
  - port\_number, 176
  - socket\_fd, 176
- tcp\_channel\_ops
  - tcp.c, 673
  - tcp.h, 674
- tcp\_init
  - tcp.c, 673
- tcp\_level
  - gdbcomm.c, 534
  - vapi.c, 873
- tcp\_open
  - tcp.c, 673
- tcp\_read
  - tcp.c, 673
- tcp\_write
  - tcp.c, 673
- temp
  - vapi\_handler, 178
- TEST\_FLAG
  - fields.h, 724
- text\_start
  - COFF\_AOUTHDR, 40
- TFLAG\_DST
  - dyn-rec.c, 335
- TFLAG\_SAVED
  - dyn-rec.c, 335
- TFLAG\_SOURCED
  - dyn-rec.c, 335
- TFLAG\_SRC
  - dyn-rec.c, 335
- tflags
  - op\_queue, 158
- ti
  - or32.c, 436

- tick.c
  - cycles\_start, 845
  - sched\_timer\_job, 843
  - spr\_read\_ttc, 843
  - spr\_write\_ttc, 843
  - spr\_write\_ttmr, 843
  - tick\_count, 845
  - tick\_one\_shot, 844
  - tick\_raise\_except, 844
  - tick\_reset, 844
  - tick\_restart, 844
- tick.h
  - spr\_read\_ttc, 846
  - spr\_write\_ttc, 846
  - spr\_write\_ttmr, 847
  - tick\_reset, 847
- tick/tick.c, 842
- tick/tick.h, 846
- tick\_count
  - tick.c, 845
- tick\_one\_shot
  - tick.c, 844
- tick\_raise\_except
  - tick.c, 844
- tick\_reset
  - tick.c, 844
  - tick.h, 847
- tick\_restart
  - tick.c, 844
- tim
  - cuc\_bb, 63
- tim\_comp
  - cuc.c, 462
- time
  - sched\_entry, 167
- time\_point
  - runtime, 165
- timing\_table
  - timings.c, 509
- timings
  - \_cuc\_func, 16
- timings.c
  - analyse\_timings, 508
  - bb\_size, 508
  - cut\_tree, 508
  - ii\_size, 508
  - insn\_size, 509
  - insn\_time, 509
  - load\_timing\_table, 509
  - mark\_cut, 509
  - max\_bb\_delay, 509
  - max\_delay, 509
  - memory\_delay, 509
  - new\_bb\_cycles, 509
  - recalc\_cnts, 509
  - timing\_table, 509
- timings\_fn
  - config, 55
- tmp
  - \_cuc\_func, 16
  - cuc\_bb, 63
  - cuc\_insn, 65
- tmp\_op
  - insn.c, 487
- tmp\_opt
  - insn.c, 487
- tms
  - mc, 147
- to
  - cuc\_conv, 64
- to\_insn\_num
  - sim-cmd.c, 801
- to\_spr
  - spr\_def, 173
- toplevel-mprofile.c, 848
  - main, 850
- toplevel-profile.c, 851
  - main, 853
- toplevel-support.c, 854
  - check\_int, 855
  - ctrl\_c, 856
  - reg\_sim\_reset, 856
  - sim\_done, 857
  - sim\_init, 857
  - sim\_reset, 858
  - sim\_reset\_hooks, 859
- toplevel-support.h, 860
  - check\_int, 860
  - ctrl\_c, 861
  - reg\_sim\_reset, 861
  - sim\_done, 862
  - sim\_init, 862
  - sim\_reset, 863
- toplevel.c, 865
  - main, 865
- total\_size
  - dma\_channel, 81
- TRACE
  - debug.h, 823
- trace.c
  - set\_insnbrkpoint, 286
- trace.h
  - set\_insnbrkpoint, 288
- TRACE\_
  - debug.h, 823
- TRACE\_ON
  - debug.h, 823
- trans\_direction

- dev\_generic, 77
- trans\_size
  - dev\_generic, 77
- transl\_error
  - parse.c, 277
- transl\_table
  - parse.c, 277
- translate
  - parse.c, 276
- TRUE
  - gdbcomm.h, 535
- ts\_bound
  - dyn\_page, 89
- tsize
  - COFF\_AOUTHDR, 40
- tty.c
  - baud\_table, 676
  - DEFAULT\_BAUD, 676
  - DEFAULT\_TTY\_DEVICE, 676
  - name, 676
  - parse\_baud, 676
  - tty\_channel\_ops, 676
  - tty\_init, 676
  - tty\_open, 676
  - value, 676
- tty.h
  - tty\_channel\_ops, 677
- tty\_channel, 177
  - fds, 177
- tty\_channel\_ops
  - tty.c, 676
  - tty.h, 677
- tty\_init
  - tty.c, 676
- tty\_open
  - tty.c, 676
- tx
  - eth\_device, 113
- tx\_bd\_num
  - eth\_device, 113
- tx\_buff
  - eth\_device, 113
- tx\_channel
  - eth\_device, 113
- txb
  - ata\_host, 26
- txbuf
  - dev\_16450, 74
- txbuf\_full
  - dev\_16450, 74
- txbuf\_head
  - dev\_16450, 74
- txbuf\_tail
  - dev\_16450, 74
- txfd
  - eth\_device, 113
- txfile
  - eth\_device, 113
- txser
  - dev\_16450, 74
- type
  - ata\_device, 22
  - BMP\_HEADER, 29
  - config\_param, 58
  - cuc\_bb, 63
  - cuc\_insn, 65
  - mem\_config, 150
  - mp\_entry, 154
  - mprofentry\_struct, 155
  - reloc, 161
- TYPE\_FILE
  - atadevice.h, 645
- TYPE\_LOCAL
  - atadevice.h, 645
- TYPE\_NO\_CONNECT
  - atadevice.h, 645
- uart16550
  - dev\_16450, 74
- uart\_16550
  - 16450.c, 608
- uart\_add\_char
  - 16450.c, 608
- UART\_ADDR\_SPACE
  - 16450.c, 601
- uart\_baseaddr
  - 16450.c, 608
- UART\_BREAK\_COUNT
  - 16450.c, 601
- uart\_channel
  - 16450.c, 608
- uart\_char\_clock
  - 16450.c, 608
- UART\_CHAR\_TIMEOUT
  - 16450.c, 601
- uart\_check\_char
  - 16450.c, 609
- uart\_check\_rdi
  - 16450.c, 609
- uart\_check\_rlsi
  - 16450.c, 609
- uart\_clear\_int
  - 16450.c, 610
- UART\_CLOCK\_DIVIDER
  - 16450.c, 601
- UART\_DLH
  - 16450.c, 601
- UART\_DLL

16450.c, 601  
uart\_enabled  
16450.c, 610  
UART\_FCR  
16450.c, 601  
UART\_FCR\_FIE  
16450.c, 601  
UART\_FCR\_RRXFI  
16450.c, 601  
UART\_FCR\_RTXFI  
16450.c, 601  
UART\_FGETC\_SLOWDOWN  
16450.c, 601  
UART\_FIFO\_TRIGGER  
16450.c, 601  
UART\_IER  
16450.c, 602  
UART\_IER\_MSI  
16450.c, 604  
UART\_IER\_RDI  
16450.c, 604  
UART\_IER\_RLSI  
16450.c, 604  
UART\_IER\_THRI  
16450.c, 604  
UART\_IIR  
16450.c, 604  
UART\_IIR\_CTI  
16450.c, 604  
UART\_IIR\_ID  
16450.c, 604  
UART\_IIR\_MSI  
16450.c, 604  
UART\_IIR\_NO\_INT  
16450.c, 604  
UART\_IIR\_RDI  
16450.c, 604  
UART\_IIR\_RLSI  
16450.c, 604  
UART\_IIR\_THRI  
16450.c, 604  
uart\_int\_cti  
16450.c, 611  
uart\_int\_msi  
16450.c, 611  
uart\_int\_rdi  
16450.c, 611  
uart\_int\_rlsi  
16450.c, 612  
uart\_int\_thri  
16450.c, 612  
uart\_irq  
16450.c, 613  
uart\_jitter  
16450.c, 613  
UART\_LCR  
16450.c, 604  
UART\_LCR\_DLAB  
16450.c, 604  
UART\_LCR\_EPAR  
16450.c, 604  
UART\_LCR\_PARITY  
16450.c, 604  
UART\_LCR\_RESET  
16450.c, 604  
UART\_LCR\_SBC  
16450.c, 604  
UART\_LCR\_SPAR  
16450.c, 604  
UART\_LCR\_STOP  
16450.c, 604  
UART\_LCR\_WLEN5  
16450.c, 604  
UART\_LCR\_WLEN6  
16450.c, 604  
UART\_LCR\_WLEN7  
16450.c, 604  
UART\_LCR\_WLEN8  
16450.c, 604  
uart\_loopback  
16450.c, 613  
UART\_LSR  
16450.c, 604  
UART\_LSR\_BREAK  
16450.c, 604  
UART\_LSR\_FRAME  
16450.c, 604  
UART\_LSR\_OVRRUN  
16450.c, 604  
UART\_LSR\_PARITY  
16450.c, 604  
UART\_LSR\_RDRDY  
16450.c, 604  
UART\_LSR\_RXERR  
16450.c, 604  
UART\_LSR\_TXBUFE  
16450.c, 604  
UART\_LSR\_TXSERE  
16450.c, 604  
UART\_MAX\_FIFO\_LEN  
16450.c, 604  
UART\_MCR  
16450.c, 604  
UART\_MCR\_AUX1  
16450.c, 605  
UART\_MCR\_AUX2  
16450.c, 605  
UART\_MCR\_DTR

- 16450.c, [605](#)
- UART\_MCR\_LOOP
  - 16450.c, [605](#)
- UART\_MCR\_RTS
  - 16450.c, [605](#)
- UART\_MSR
  - 16450.c, [605](#)
- UART\_MSR\_CTS
  - 16450.c, [605](#)
- UART\_MSR\_DCD
  - 16450.c, [605](#)
- UART\_MSR\_DCTS
  - 16450.c, [605](#)
- UART\_MSR\_DDCD
  - 16450.c, [605](#)
- UART\_MSR\_DDSR
  - 16450.c, [605](#)
- UART\_MSR\_DSR
  - 16450.c, [605](#)
- UART\_MSR\_RI
  - 16450.c, [605](#)
- UART\_MSR\_TERI
  - 16450.c, [605](#)
- uart\_newway
  - 16450.c, [613](#)
- uart\_next\_int
  - 16450.c, [614](#)
- uart\_read\_byte
  - 16450.c, [614](#)
- uart\_rcv\_break
  - 16450.c, [614](#)
- uart\_rcv\_break\_start
  - 16450.c, [614](#)
- uart\_rcv\_break\_stop
  - 16450.c, [615](#)
- uart\_rcv\_char
  - 16450.c, [615](#)
- uart\_reset
  - 16450.c, [615](#)
  - 16450.h, [623](#)
- UART\_RXBUF
  - 16450.c, [605](#)
- uart\_sched\_rcv\_check
  - 16450.c, [616](#)
- UART\_SCR
  - 16450.c, [605](#)
- uart\_sec\_end
  - 16450.c, [616](#)
- uart\_sec\_start
  - 16450.c, [617](#)
- uart\_send\_break
  - 16450.c, [617](#)
- uart\_status
  - 16450.c, [618](#)
- 16450.h, [623](#)
- uart\_tx\_send
  - 16450.c, [618](#)
- UART\_TXBUF
  - 16450.c, [605](#)
- UART\_VALID\_FCR
  - 16450.c, [605](#)
- UART\_VALID\_IER
  - 16450.c, [605](#)
- UART\_VALID\_IIR
  - 16450.c, [605](#)
- UART\_VALID\_LCR
  - 16450.c, [605](#)
- UART\_VALID\_LSR
  - 16450.c, [605](#)
- UART\_VALID\_MCR
  - 16450.c, [605](#)
- UART\_VALID\_MSR
  - 16450.c, [605](#)
- UART\_VAPI\_BUF\_LEN
  - 16450.c, [605](#)
- uart\_vapi\_cmd
  - 16450.c, [618](#)
- uart\_vapi\_id
  - 16450.c, [619](#)
- uart\_vapi\_read
  - 16450.c, [619](#)
- uart\_write\_byte
  - 16450.c, [619](#)
- ULONGEST
  - abstract.h, [231](#)
- unmark\_tree
  - insn.c, [487](#)
- unroll
  - cuc\_timings, [69](#)
- unrolled
  - cuc\_bb, [63](#)
- uorreg\_t
  - arch.h, [291](#)
- upd\_reg\_from\_t
  - op-support.h, [410](#)
- upd\_sim\_cycles
  - common-i386.h, [325](#)
- update\_pc
  - execute.c, [375](#)
- used\_regs
  - \_cuc\_func, [16](#)
- useless\_x86
  - common-i386.h, [325](#)
- ustates
  - config, [55](#)
  - dmmu, [86](#)
  - ic, [127](#)
  - immu, [129](#)



- ustates\_reload
  - ic, [127](#)
- val3232
  - common-i386.h, [325](#)
- val64
  - common-i386.h, [325](#)
- valid
  - dev\_memarea, [79](#)
- value
  - dev\_generic, [77](#)
  - tty.c, [676](#)
- vapi
  - config, [55](#)
  - dev\_16450, [74](#)
  - runtime, [165](#)
- vapi.c
  - add\_handler, [869](#)
  - fds, [873](#)
  - find\_handler, [869](#)
  - get\_server\_socket, [869](#)
  - handler\_fits\_id, [870](#)
  - nfds, [873](#)
  - nhandlers, [873](#)
  - read\_packet, [870](#)
  - rebuild\_fds, [870](#)
  - reg\_vapi\_sec, [870](#)
  - server\_fd, [873](#)
  - server\_request, [870](#)
  - serverIP, [873](#)
  - tcp\_level, [873](#)
  - vapi\_check, [870](#)
  - vapi\_done, [871](#)
  - vapi\_enabled, [871](#)
  - vapi\_file, [871](#)
  - vapi\_hide\_device\_id, [871](#)
  - vapi\_init, [871](#)
  - vapi\_install\_handler, [871](#)
  - vapi\_install\_multi\_handler, [872](#)
  - vapi\_log\_enabled, [872](#)
  - vapi\_log\_fn, [872](#)
  - vapi\_num\_unconnected, [872](#)
  - vapi\_read\_stream, [872](#)
  - vapi\_request, [872](#)
  - vapi\_send, [872](#)
  - vapi\_server\_port, [873](#)
  - vapi\_write\_log\_file, [873](#)
  - vapi\_write\_stream, [873](#)
  - write\_packet, [873](#)
- vapi.h
  - reg\_vapi\_sec, [875](#)
  - VAPI\_COMMAND\_END, [874](#)
  - VAPI\_COMMAND\_REQUEST, [874](#)
  - VAPI\_COMMAND\_SEND, [874](#)
  - vapi\_check, [875](#)
  - VAPI\_COMMAND, [874](#)
  - vapi\_done, [875](#)
  - vapi\_init, [875](#)
  - vapi\_install\_handler, [876](#)
  - vapi\_install\_multi\_handler, [876](#)
  - VAPI\_MAX\_DEVID, [874](#)
  - vapi\_num\_unconnected, [876](#)
  - vapi\_send, [876](#)
  - vapi\_write\_log\_file, [876](#)
- vapi/vapi.c, [868](#)
- vapi/vapi.h, [874](#)
- VAPI\_COMMAND\_END
  - vapi.h, [874](#)
- VAPI\_COMMAND\_REQUEST
  - vapi.h, [874](#)
- VAPI\_COMMAND\_SEND
  - vapi.h, [874](#)
- vapi\_buf
  - dev\_16450, [74](#)
- vapi\_buf\_head\_ptr
  - dev\_16450, [74](#)
- vapi\_buf\_tail\_ptr
  - dev\_16450, [74](#)
- vapi\_check
  - vapi.c, [870](#)
  - vapi.h, [875](#)
- VAPI\_COMMAND
  - vapi.h, [874](#)
- vapi\_done
  - vapi.c, [871](#)
  - vapi.h, [875](#)
- vapi\_enabled
  - vapi.c, [871](#)
- vapi\_file
  - runtime, [165](#)
- vapi\_fn
  - config, [55](#)
- vapi\_handler, [178](#)
  - base\_id, [178](#)
  - fd, [178](#)
  - next, [178](#)
  - num\_ids, [178](#)
  - priv\_dat, [178](#)
  - read\_func, [178](#)
  - temp, [178](#)
- vapi\_hide\_device\_id
  - vapi.c, [871](#)
- vapi\_id
  - config, [55](#)
  - dev\_16450, [74](#)
  - dma\_controller, [84](#)
- vapi\_init
  - vapi.c, [871](#)
  - vapi.h, [875](#)

- vapi\_install\_handler
  - vapi.c, [871](#)
  - vapi.h, [876](#)
- vapi\_install\_multi\_handler
  - vapi.c, [872](#)
  - vapi.h, [876](#)
- vapi\_log\_enabled
  - vapi.c, [872](#)
- vapi\_log\_fn
  - vapi.c, [872](#)
- VAPI\_MAX\_DEVID
  - vapi.h, [874](#)
- vapi\_num\_unconnected
  - vapi.c, [872](#)
  - vapi.h, [876](#)
- vapi\_read\_stream
  - vapi.c, [872](#)
- vapi\_request
  - vapi.c, [872](#)
- vapi\_send
  - vapi.c, [872](#)
  - vapi.h, [876](#)
- vapi\_server\_port
  - vapi.c, [873](#)
- vapi\_write\_log\_file
  - vapi.c, [873](#)
  - vapi.h, [876](#)
- vapi\_write\_stream
  - vapi.c, [873](#)
- vbar
  - vga\_state, [180](#)
- vbindx
  - vga\_state, [180](#)
- verbose
  - config, [55](#)
- verify\_memoryarea
  - abstract.c, [228](#)
  - abstract.h, [243](#)
- verilog.c
  - branch\_index, [511](#)
  - find\_lsc\_index, [511](#)
  - func\_index, [511](#)
  - GEN, [511](#)
  - generate\_main, [511](#)
  - output\_verilog, [511](#)
  - print\_deps, [511](#)
  - print\_insn\_v, [512](#)
  - print\_op\_v, [512](#)
  - print\_turn\_off\_dep, [512](#)
- verilog.h
  - generate\_main, [513](#)
  - output\_verilog, [513](#)
- vga.c
  - reg\_vga\_sec, [763](#)
  - VGA\_ADDR\_SPACE, [763](#)
  - vga\_baseaddr, [764](#)
  - VGA\_CLUTA, [763](#)
  - VGA\_CLUTB, [763](#)
  - VGA\_CTRL, [763](#)
  - VGA\_CTRL\_CD, [763](#)
  - VGA\_CTRL\_PC, [763](#)
  - VGA\_CTRL\_VEN, [763](#)
  - vga\_dump\_image, [764](#)
  - vga\_enabled, [764](#)
  - vga\_filename, [764](#)
  - VGA\_HTIM, [763](#)
  - VGA\_HVLEN, [763](#)
  - vga\_irq, [764](#)
  - vga\_job, [765](#)
  - VGA\_MASK, [763](#)
  - vga\_read32, [765](#)
  - vga\_refresh\_rate, [765](#)
  - vga\_reset, [765](#)
  - vga\_sec\_end, [765](#)
  - vga\_sec\_start, [766](#)
  - VGA\_STAT, [763](#)
  - VGA\_VBARA, [763](#)
  - VGA\_VBARB, [763](#)
  - VGA\_VTIM, [763](#)
  - vga\_write32, [766](#)
- vga.h
  - reg\_vga\_sec, [767](#)
- VGA\_ADDR\_SPACE
  - vga.c, [763](#)
- vga\_baseaddr
  - vga.c, [764](#)
- VGA\_CLUTA
  - vga.c, [763](#)
- VGA\_CLUTB
  - vga.c, [763](#)
- VGA\_CTRL
  - vga.c, [763](#)
- VGA\_CTRL\_CD
  - vga.c, [763](#)
- VGA\_CTRL\_PC
  - vga.c, [763](#)
- VGA\_CTRL\_VEN
  - vga.c, [763](#)
- vga\_dump\_image
  - vga.c, [764](#)
- vga\_enabled
  - vga.c, [764](#)
- vga\_filename
  - vga.c, [764](#)
- VGA\_HTIM
  - vga.c, [763](#)
- VGA\_HVLEN
  - vga.c, [763](#)

- vga\_irq
  - vga.c, 764
- vga\_job
  - vga.c, 765
- VGA\_MASK
  - vga.c, 763
- vga\_read32
  - vga.c, 765
- vga\_refresh\_rate
  - vga.c, 765
- vga\_reset
  - vga.c, 765
- vga\_sec\_end
  - vga.c, 765
- vga\_sec\_start
  - vga.c, 766
- VGA\_STAT
  - vga.c, 763
- vga\_state, 179
  - baseaddr, 180
  - ctrl, 180
  - enabled, 180
  - filename, 180
  - hlen, 180
  - htim, 180
  - irq, 180
  - palette, 180
  - pics, 180
  - pindex, 180
  - refresh\_rate, 180
  - stat, 180
  - vbar, 180
  - vbindx, 180
  - vlen, 180
  - vtim, 180
- VGA\_VBARA
  - vga.c, 763
- VGA\_VBARB
  - vga.c, 763
- VGA\_VTIM
  - vga.c, 763
- vga\_write32
  - vga.c, 766
- vlen
  - vga\_state, 180
- vpn\_mask
  - dmmu, 86
  - immu, 129
- vstamp
  - COFF\_AOUTHDR, 40
- vtim
  - vga\_state, 180
- wait\_for\_tcp\_connect
  - tcp.c, 673
- waiting\_for\_dma
  - eth\_device, 113
- WARN
  - debug.h, 823
- WARN\_
  - debug.h, 823
- WARN\_ON
  - debug.h, 823
- WARNING
  - cpu-config.c, 207
- way
  - bpb\_entry, 30
  - btic\_entry, 34
  - dc\_set, 70
- wfds
  - eth\_device, 113
- width
  - INFOHEADER, 131
- word\_enabled
  - dev\_generic, 77
- words\_transferred
  - dma\_channel, 81
- working
  - eth\_device, 113
- WP\_ACCESS
  - rsp-server.c, 540
- WP\_READ
  - rsp-server.c, 540
- WP\_WRITE
  - rsp-server.c, 540
- write
  - channel\_ops, 39
- WRITE\_BUFFER
  - atacmd.h, 627
- write\_dat16
  - mem\_ops, 152
- write\_dat32
  - mem\_ops, 152
- write\_dat8
  - mem\_ops, 152
- WRITE\_DMA
  - atacmd.h, 627
- WRITE\_DMA\_QUEUED
  - atacmd.h, 627
- WRITE\_MULTIPLE
  - atacmd.h, 627
- write\_packet
  - vapi.c, 873
- WRITE\_SECTOR
  - atacmd.h, 627
- WRITE\_SECTORS
  - atacmd.h, 627
- write\_to\_reg

- generate.c, 379
- write\_up
  - config, 55
- writelfunc16
  - mem\_ops, 152
- writelfunc32
  - mem\_ops, 152
- writelfunc8
  - mem\_ops, 152
- writehit
  - cachestats\_entry, 36
- writemiss
  - cachestats\_entry, 36
- writeprog32
  - mem\_ops, 152
- writeprog32\_dat
  - mem\_ops, 152
- writeprog8
  - mem\_ops, 152
- writeprog8\_dat
  - mem\_ops, 152
- x\_ary
  - COFF\_auxent, 43
- x\_dimen
  - COFF\_auxent, 43
- x\_endndx
  - COFF\_auxent, 43
- x\_fcn
  - COFF\_auxent, 43
- x\_fcny
  - COFF\_auxent, 43
- x\_file
  - COFF\_auxent, 43
- x\_fname
  - COFF\_auxent, 43
- x\_fsize
  - COFF\_auxent, 43
- x\_inno
  - COFF\_auxent, 43
- x\_innoptr
  - COFF\_auxent, 43
- x\_insz
  - COFF\_auxent, 43
- x\_misc
  - COFF\_auxent, 43
- x\_n
  - COFF\_auxent, 43
- x\_nlinno
  - COFF\_auxent, 43
- x\_nreloc
  - COFF\_auxent, 43
- x\_offset
  - COFF\_auxent, 43
- x\_scn
  - COFF\_auxent, 43
- x\_scnlen
  - COFF\_auxent, 43
- x\_size
  - COFF\_auxent, 43
- x\_sym
  - COFF\_auxent, 43
- x\_tagndx
  - COFF\_auxent, 43
- x\_tv
  - COFF\_auxent, 43
- x\_tvfill
  - COFF\_auxent, 43
- x\_tvlen
  - COFF\_auxent, 43
- x\_tvndx
  - COFF\_auxent, 43
- x\_tvran
  - COFF\_auxent, 43
- x\_zeroes
  - COFF\_auxent, 43
- xchg\_insn
  - load.c, 497
- xglue
  - dyn-rec.h, 353
- xref
  - op\_queue, 158
- xresolution
  - INFOHEADER, 131
- xterm.c
  - basename, 679
  - MAX\_XTERM\_ARGS, 679
  - xterm\_channel\_ops, 679
  - xterm\_close, 679
  - xterm\_init, 679
  - xterm\_open, 679
- xterm.h
  - xterm\_channel\_ops, 680
- xterm\_channel, 181
  - argv, 181
  - fds, 181
  - pid, 181
- xterm\_channel\_ops
  - xterm.c, 679
  - xterm.h, 680
- xterm\_close
  - xterm.c, 679
- xterm\_init
  - xterm.c, 679
- xterm\_open
  - xterm.c, 679
- yresolution

INFOHEADER, [131](#)