

IOports_rs232_rdx	52	IO/D1
IO_conn_pln2	50	IO/D2
IO_conn_pln4	49	IO/D3
IO_conn_pln6	46	IO/D3
IOports_clk_sel_1	44	IO/MOSI/CSL_B
IOports_clk_sel_2	41	IO/GCLK1
IOports_clk_sel_3	40	IO/GCLK15
IO_conn_pln1	39	IO/VREF
IO_conn_pln3	37	IO/D4
IO_conn_pln5	36	IO/D5
IO_conn_pln7	35	IO/D6
IO_conn_pln8	34	IO/D7
IO_conn_pln9	33	IO
IO_conn_pln10	32	IO
IO_conn_pln11	31	IO/VS0
IO_conn_pln12	30	IO/VS1
IO_conn_pln13	29	IO/VS2
IO_conn_pln15	28	IO/RDWR_B
IO_conn_pln17	27	IO/CS0_B
IO_MOD_pin1	21	IO/VREF
IO_MOD_pin2	20	IO
IO_MOD_pin3	19	IO
IO_MOD_pin4	16	IO/HLCLK7
IO_MOD_pin5	15	IO/LHCLK6
IO_MOD_pin6	13	IO/LHCLK3
IO_MOD_pin7	12	IO/LHCLK2
IO_MOD_pin9	10	IO/LHCLK1
IOports_sw_B	9	IO/VREF
IOports_led_B	7	IO
IOports_sw_7	6	IO
IOports_led_7	5	IO
IOports_sw_6	4	IO
IOports_led_6	3	IO

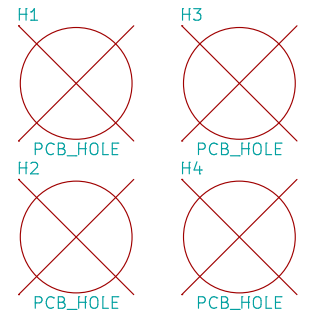
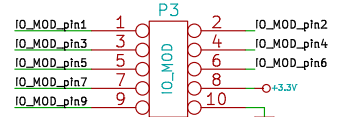
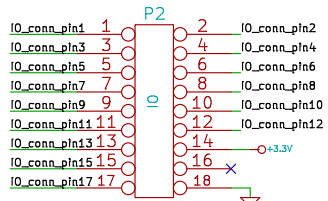
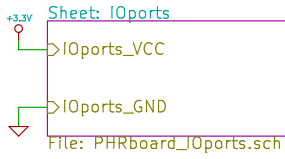
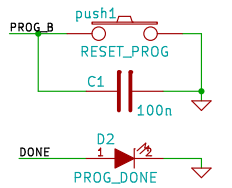
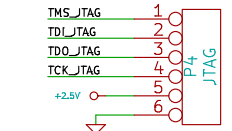
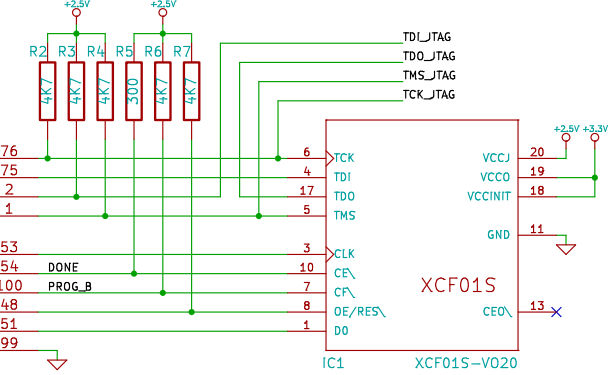
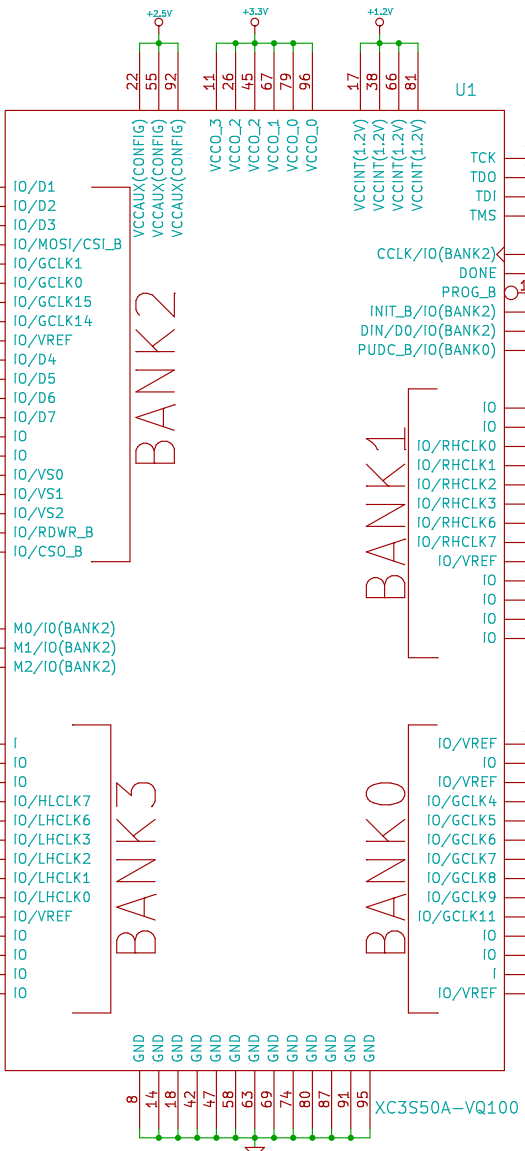

Facultad Regional Córdoba		
Universidad Tecnológica Nacional		
Centro Universitario de Automoción y Robótica		
File: PHRboard.sch		
Sheet: /		
Title: PHR Board		
Size: A4	Date: 17 aug 2013	Rev: 1.0
KiCad E.D.A. eeschema (2012-apr-16-27)-stable		Id: 1/3