

Low noise low drop voltage regulator with shutdown function

Features

- Output current up to 200 mA
- Low dropout voltage (500 mV max at $I_{OUT} = 200$ mA)
- Very low quiescent current: 0.1 μ A in OFF mode and max 250 μ A in ON mode at $I_{OUT} = 0$ mA
- Low output noise: typ. 30 μ V at $I_{OUT} = 60$ mA and 10 Hz < f < 80 kHz
- Wide range of output voltages
- Internal current and thermal limit
- V_{OUT} tolerance $\pm 2\%$ (at 25 °C)
- Operative input voltage from:
 $V_{OUT} + 0.5$ to 14 V (for $V_{OUT} > 2$ V)
 or from 2.5 V to 14 V (for $V_{OUT} < 2$ V)

Description

The LK112Sxx is a low dropout linear regulator with a built in electronic switch. The internal switch can be controlled by TTL or CMOS logic levels. The device is ON state when the control pin is pulled to a logic high level. An external capacitor can be used connected to the noise bypass pin to lower the output noise level to 30

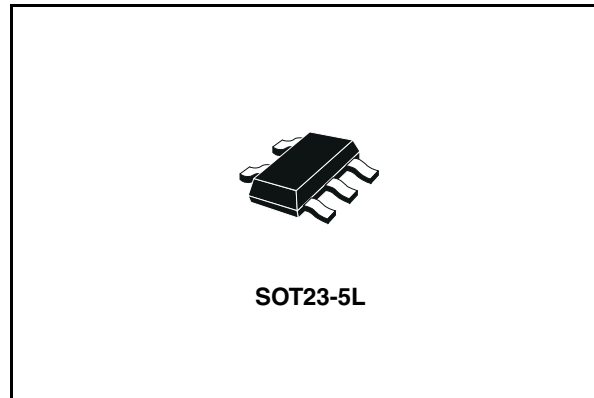

μ Vrms. An internal PNP pass transistor is used to achieve a low dropout voltage.

The LK112Sxx has a very low quiescent current in ON MODE while in OFF MODE the I_q is reduced down to 100 nA max. The internal thermal shutdown circuitry limits the junction temperature to below 150 °C. The load current is internally monitored and the device will shutdown in the presence of a short circuit or overcurrent condition at the output.

Table 1. Device summary

Part numbers			
LK112SXX13	LK112SXX24	LK112SXX36	LK112SXX45
LK112SXX14	LK112SXX26	LK112SXX37	LK112SXX46
LK112SXX18	LK112SXX28	LK112SXX38	LK112SXX47
LK112SXX19	LK112SXX29	LK112SXX39	LK112SXX48
LK112SXX20	LK112SXX31	LK112SXX41	LK112SXX49
LK112SXX21	LK112SXX33	LK112SXX42	LK112SXX50
LK112SXX22	LK112SXX34	LK112SXX43	
LK112SXX23	LK112SXX35	LK112SXX44	

Contents

1	Diagram	3
2	Pin configuration	4
3	Maximum ratings	5
4	Electrical characteristics	6
5	Typical characteristics	7
6	Package mechanical data	12
7	Order codes	15
8	Revision history	16

1 Diagram

Figure 1. Schematic diagram

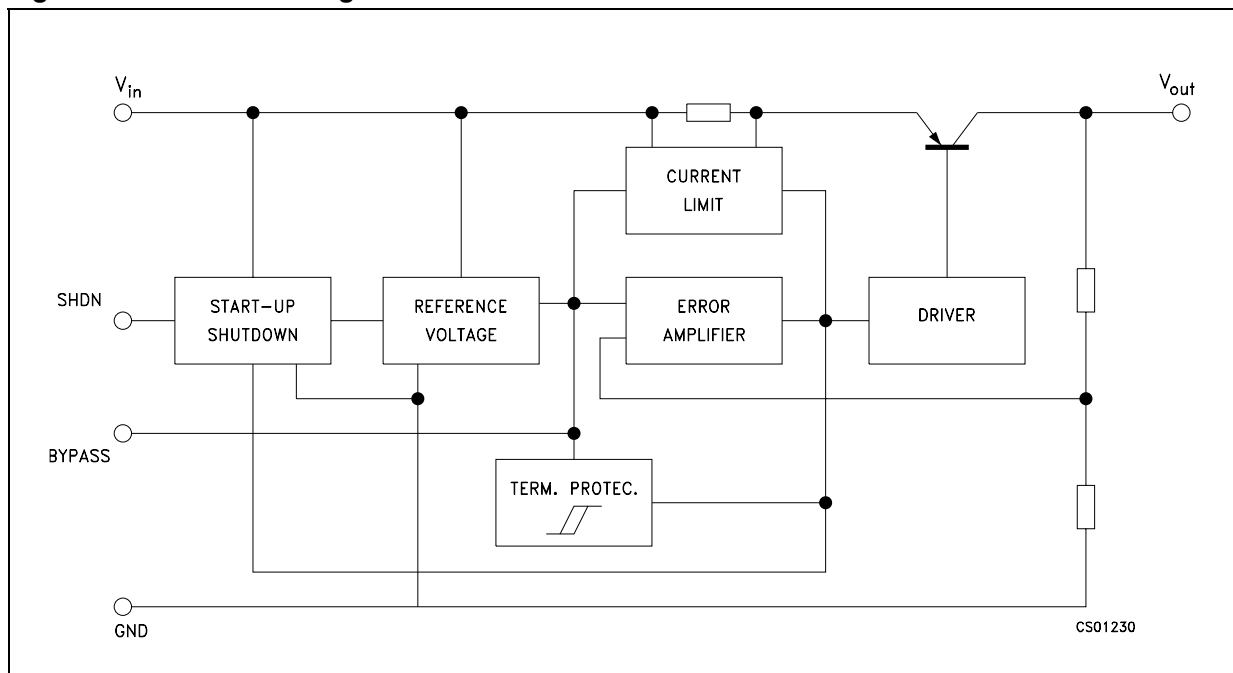

2 Pin configuration

Figure 2. Pin connection (top view)

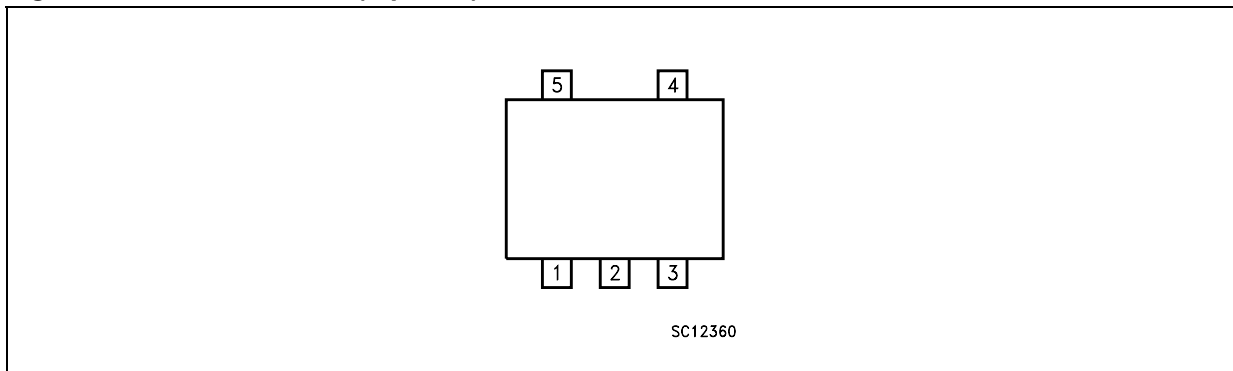

Table 2. Pin description

Pin n°	Symbol	Note
1	SHDN	Shutdown Input: Disables the regulator when is connected to GND or to positive voltage less than 0.6 V
2	GND	Ground Pin: Internally connected to the die attach flag to decrease the total thermal resistance and increase the package ability to dissipate power.
3	Bypass	Bypass Pin: Bypass with 0.1 μ F to improve the V_{REF} thermal noise performances.
4	OUT	Output port
5	IN	Input port

3 Maximum ratings

Table 3. Absolute maximum ratings

Symbol	Parameter	Value	Unit
V_I	DC input voltage	16	V
V_{SHDN}	DC input voltage	16	V
I_O	Output current	Internally limited	
T_{STG}	Storage temperature range	-55 to 150	°C
T_{OP}	Operating junction temperature range	-40 to 125	°C

Table 4. Thermal data

Symbol	Parameter	SOT23-5L	Unit
R_{thJC}	Thermal resistance junction-case	81	°C/W
R_{thJA}	Thermal resistance junction-ambient	255	°C/W

4 Electrical characteristics

Table 5. Electrical characteristics for LK112S ($T_J = 25\text{ }^\circ\text{C}$, $V_{IN} = V_{OUT} + 1\text{ V}$ ⁽¹⁾, $I_{OUT} = 0\text{ mA}$, $V_{SHDN} = 1.8\text{ V}$, $C_I = 1\text{ }\mu\text{F}$, $C_O = 2.2\text{ }\mu\text{F}$, $C_{BYPASS} = 0.1\text{ }\mu\text{F}$ unless otherwise specified)

Symbol	Parameter	Test conditions	Min.	Typ.	Max.	Unit
I_d	Quiescent current	ON MODE (except I_{SHDN})		175	250	μA
		OFF MODE, $V_I = 8\text{ V}$, $V_{SHDN} = 0\text{ V}$		0	0.1	μA
V_O	Output voltage	$I_O = 30\text{ mA}$	(see table)			
ΔV_O	Line regulation	$V_I = V_O + 1\text{ V}$ to $V_O + 6\text{ V}$, $V_O \leq 5.6\text{ V}$		0.7	20	mV
		$V_I = V_O + 1\text{ V}$ to $V_O + 6\text{ V}$, $V_O > 5.6\text{ V}$		0.8	40	mV
ΔV_O	Load regulation	$I_O = 1$ to 60 mA		15	30	mV
		$I_O = 1$ to 200 mA		30	90	mV
V_d	Dropout voltage	$I_O = 60\text{ mA}$ ⁽²⁾		0.17	0.24	V
		$I_O = 200\text{ mA}$ ⁽²⁾		0.35	0.5	V
I_{SC}	Short circuit current		200			mA
SVR	Supply voltage rejection	$V_I = V_O + 1.5\text{ V}$, $C_{BYP} = 0.1\text{ }\mu\text{F}$ $C_O = 10\text{ }\mu\text{F}$, $f = 400\text{ Hz}$, $I_O = 30\text{ mA}$		55		dB
eN	Output noise voltage	$B = 10\text{ Hz}$ to 80 kHz , $C_{BYP} = 0.1\text{ }\mu\text{F}$ $C_O = 10\text{ }\mu\text{F}$, $V_I = V_O + 1.5\text{ V}$, $I_O = 60\text{ mA}$		30		μV_{rms}
I_{SHDN}	Shutdown input current	$V_{SHDN} = 1.8\text{ V}$, Output ON		12	35	μA
V_{SHDN}	Shutdown input logic	Output ON	1.8			V
		Output OFF			0.6	
$\Delta V_O/T_J$	Output voltage temperature coefficient	$I_O = 10\text{ mA}$		0.09		mV/ $^\circ\text{C}$

1. For version with output voltage less than 2V $V_{IN} = 2.4\text{ V}$
2. Only for version with output voltage more than 2.1V

5 Typical characteristics

(Unless otherwise specified, $T_J = 25\text{ }^\circ\text{C}$, $C_I = 1\text{ }\mu\text{F}$, $C_O = 2.2\text{ }\mu\text{F}$, $C_{BYP} = 100\text{ nF}$)

Figure 3. Output voltage vs temperature

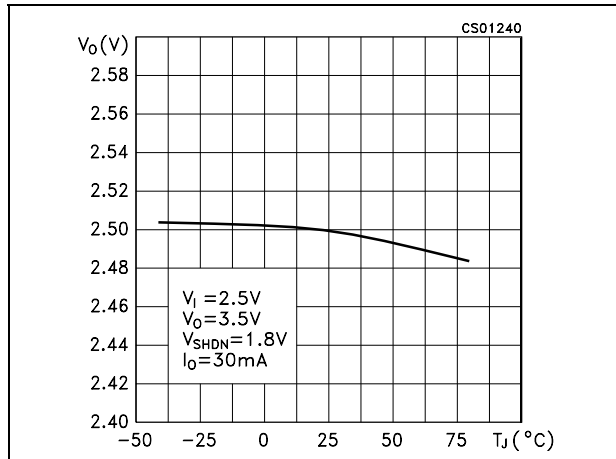

Figure 4. Output voltage vs temperature

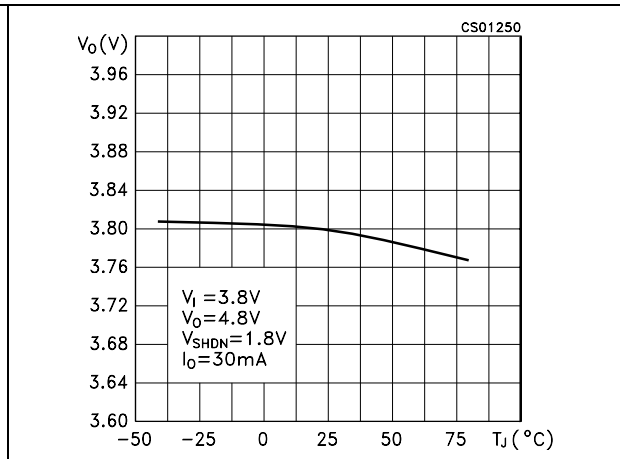

Figure 5. Line regulation vs temperature

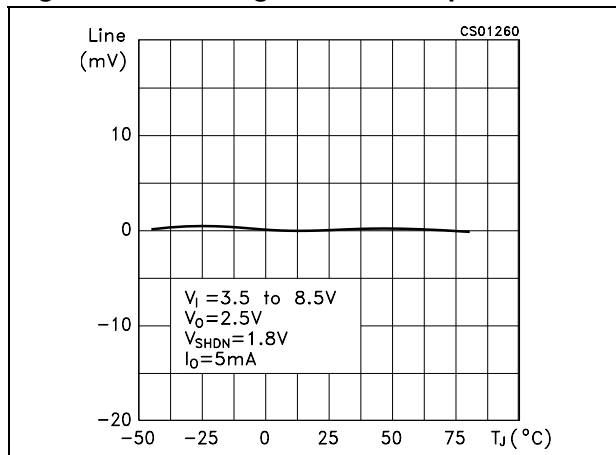

Figure 6. Load regulation vs temperature

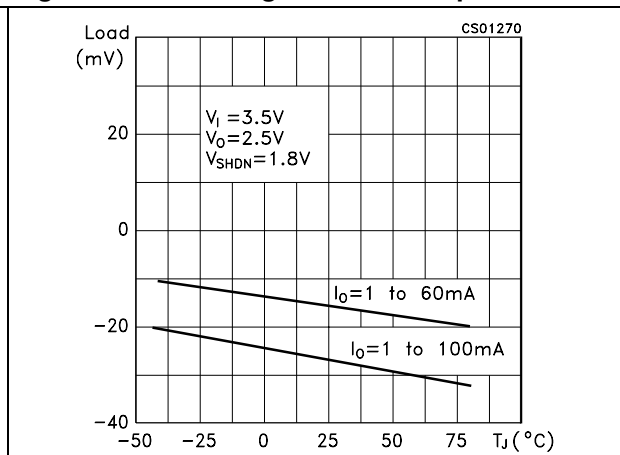

Figure 7. Dropout voltage vs temperature

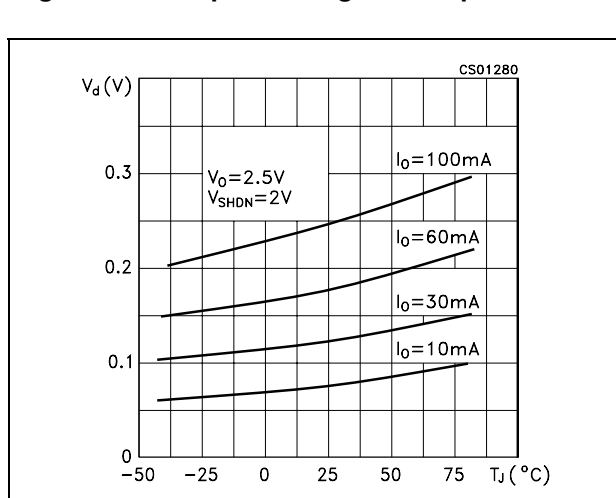

Figure 8. Short circuit current vs dropout voltage

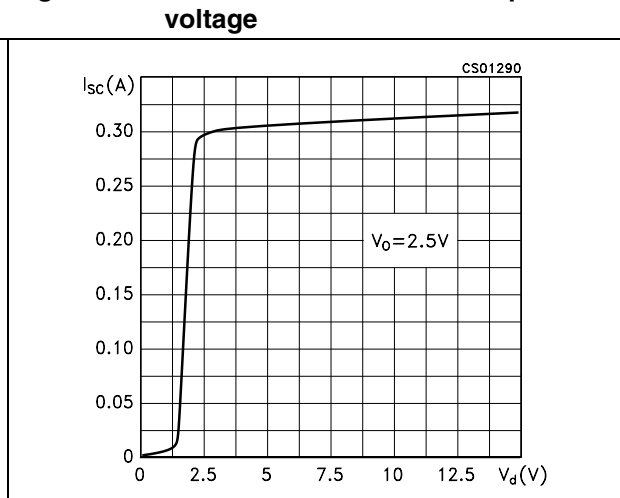

Figure 9. Output voltage vs input voltage

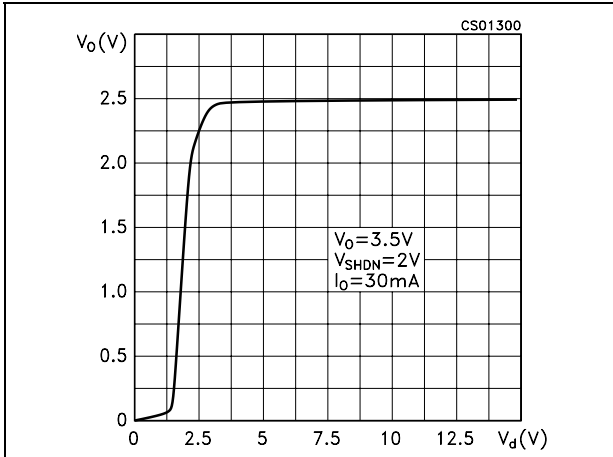

Figure 10. Shutdown voltage vs temperature

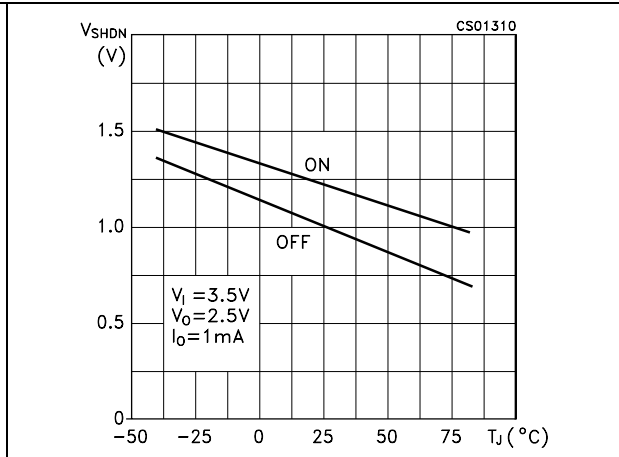

Figure 11. Shutdown current vs shutdown voltage

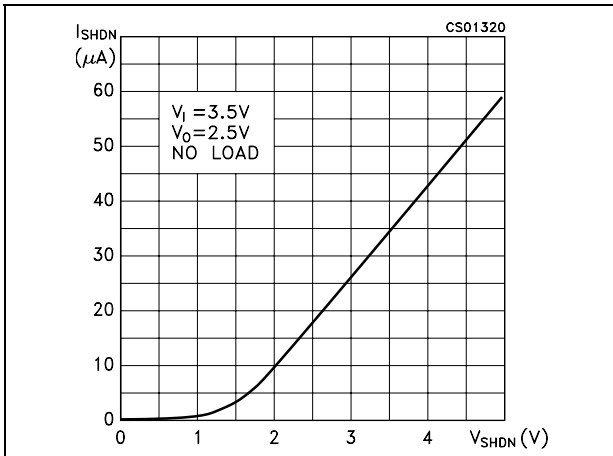

Figure 12. Supply voltage rejection vs temperature

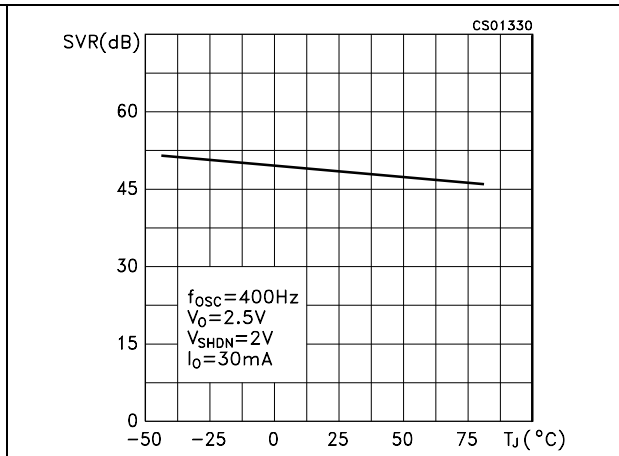

Figure 13. Supply voltage rejection vs output current

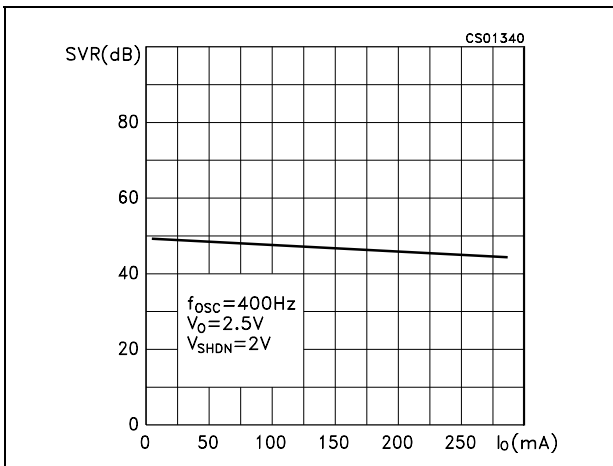

Figure 14. Supply voltage rejection vs frequency

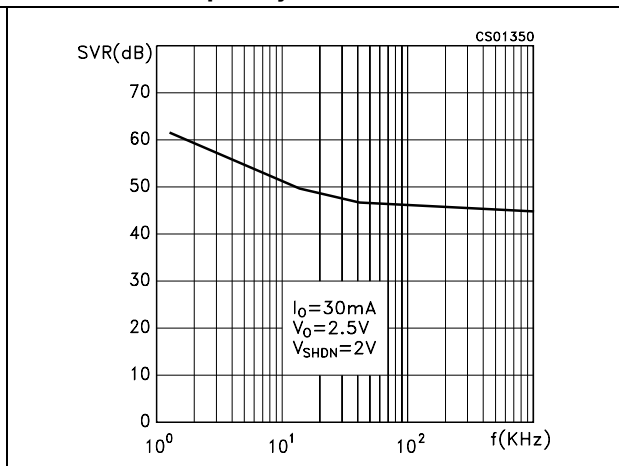

Figure 15. Supply voltage rejection vs temperature

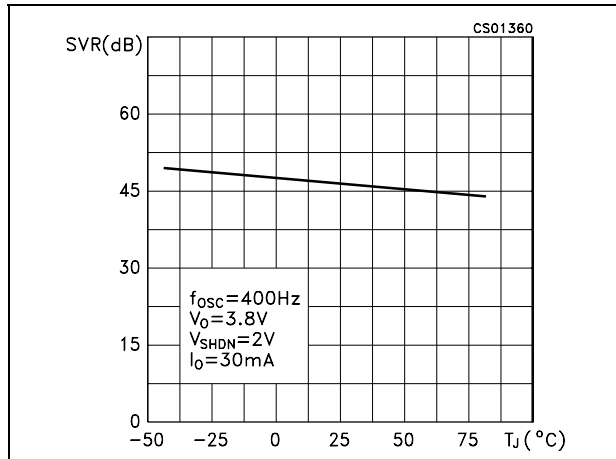

Figure 16. Quiescent current vs temperature

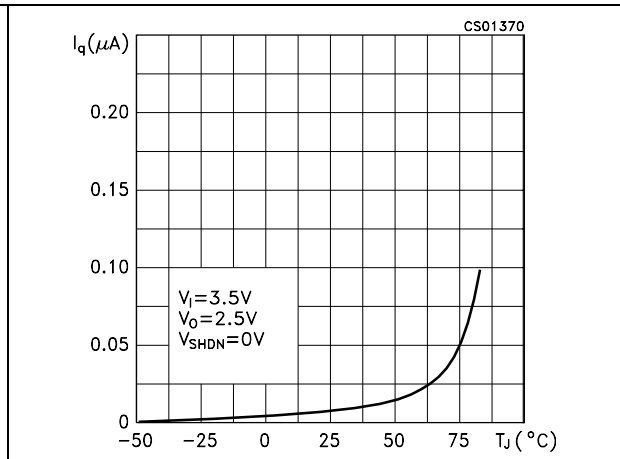

Figure 17. Quiescent current vs input voltage

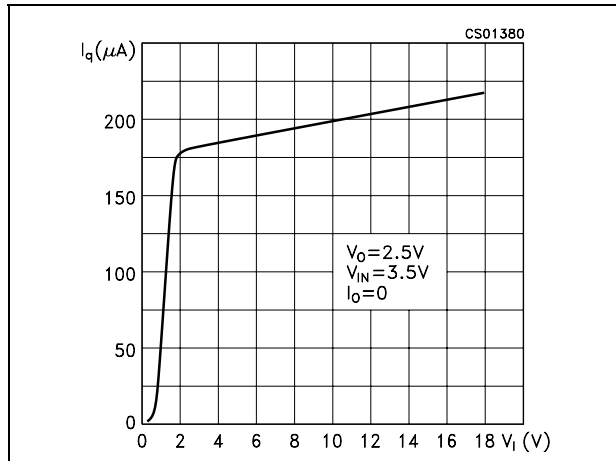

Figure 18. Quiescent current vs shutdown voltage

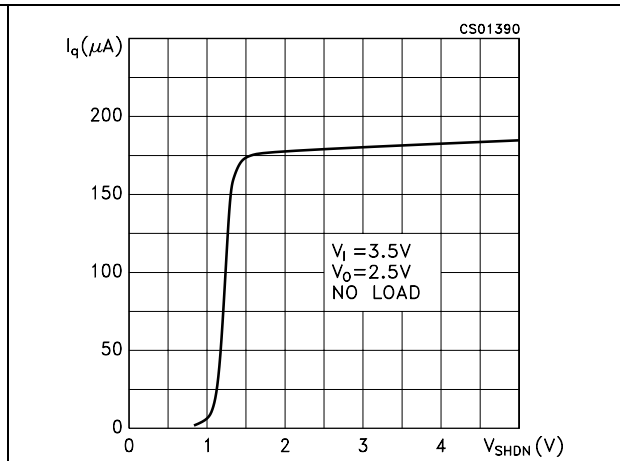

Figure 19. Quiescent current vs temperature

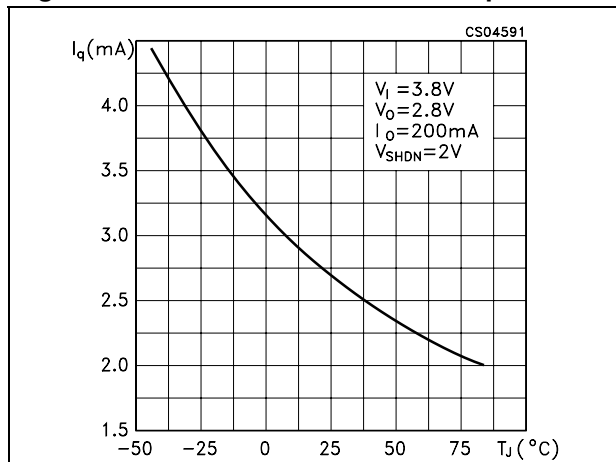

Figure 20. Reverse current vs reverse voltage

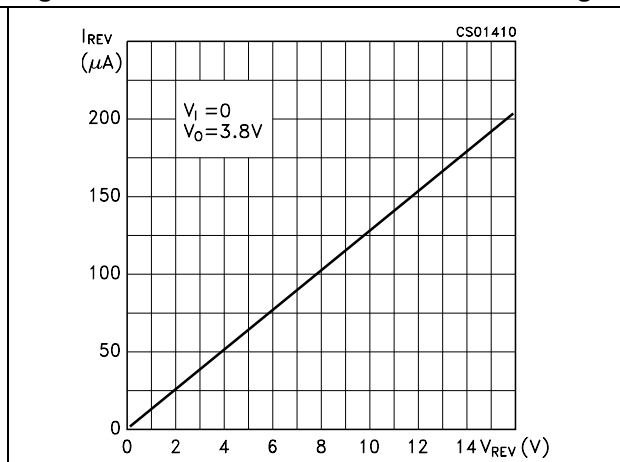

Figure 21. Stability

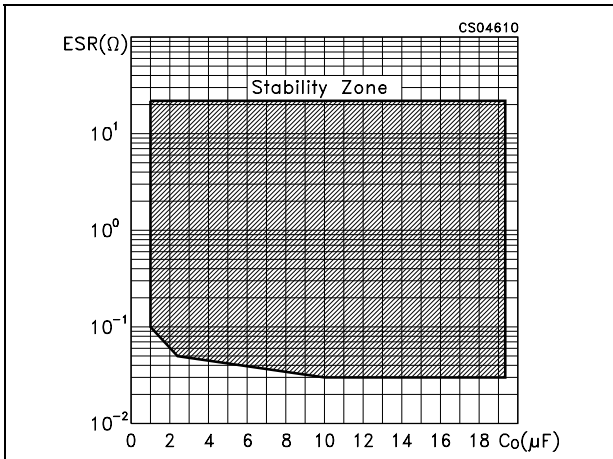

Figure 22. Spectrum noise

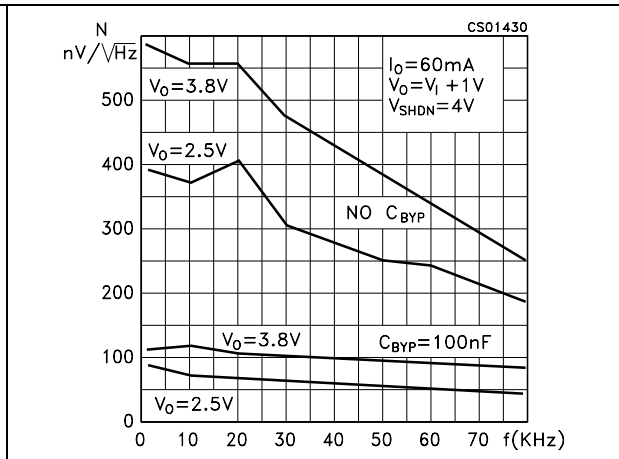

Figure 23. Start-up transient

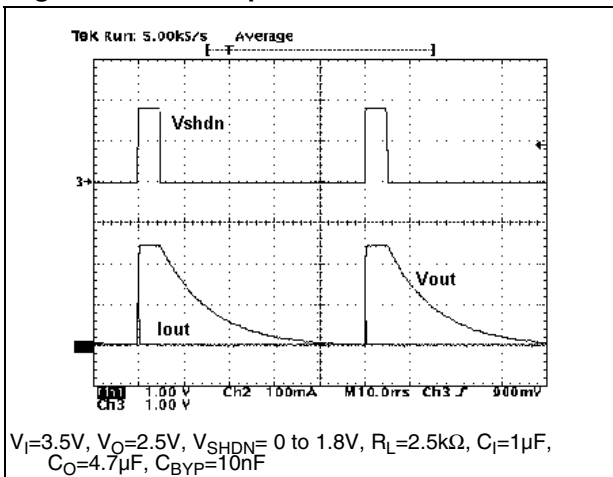

Figure 24. Start-up transient

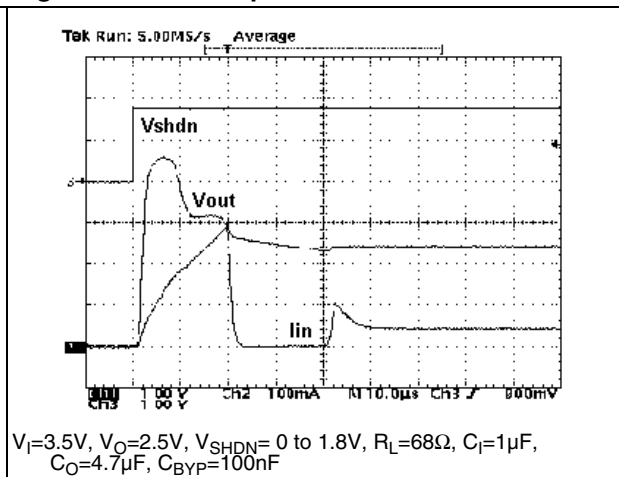

Figure 25. Line transient

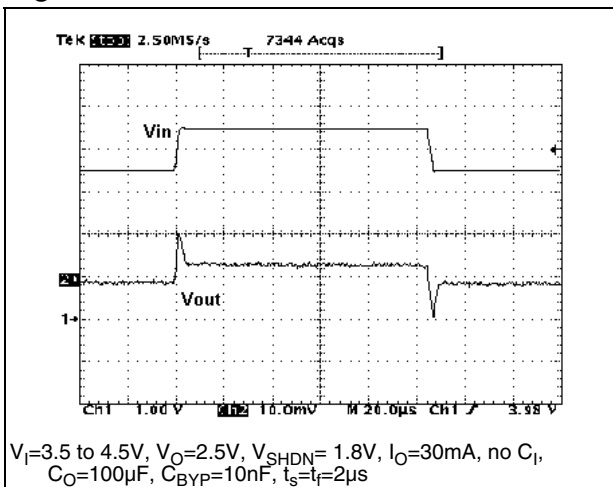

Figure 26. Line transient

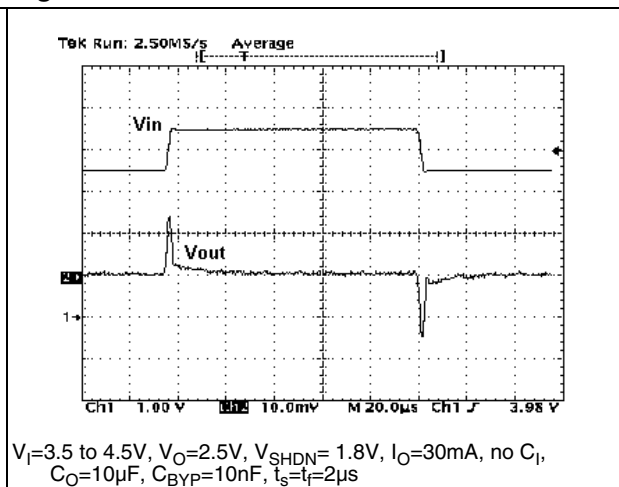

Figure 27. Line transient

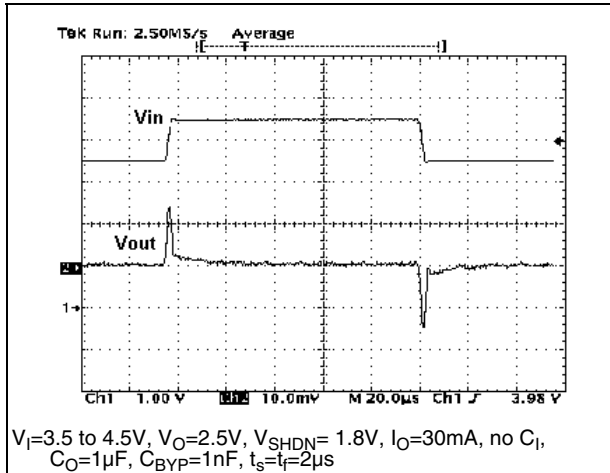

Figure 28. Load transient

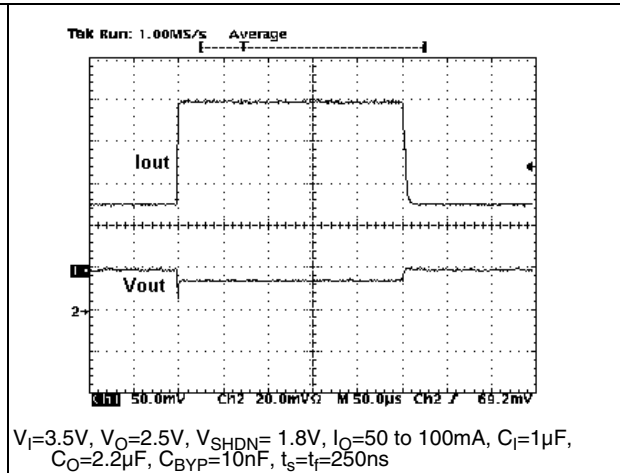

Figure 29. Load transient

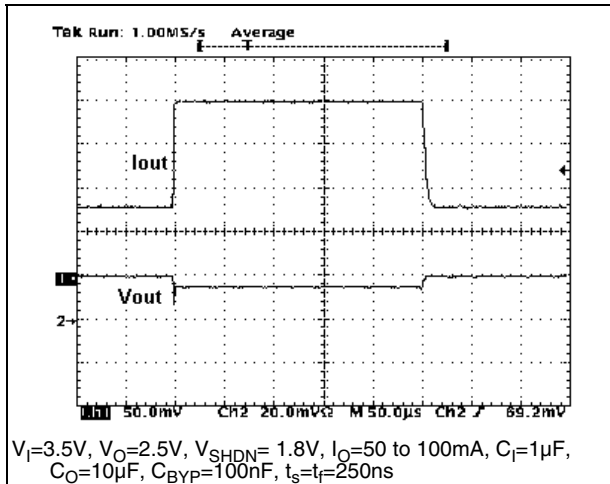
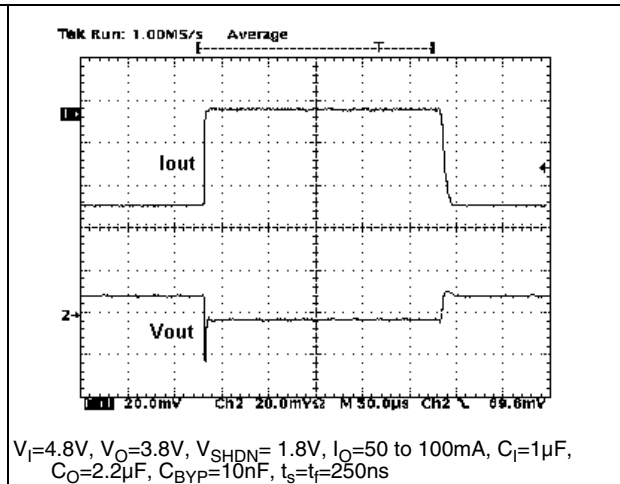

Figure 30. Load transient



6 Package mechanical data

In order to meet environmental requirements, ST offers these devices in ECOPACK[®] packages. These packages have a lead-free second level interconnect. The category of second Level Interconnect is marked on the package and on the inner box label, in compliance with JEDEC Standard JESD97. The maximum ratings related to soldering conditions are also marked on the inner box label. ECOPACK is an ST trademark. ECOPACK specifications are available at: www.st.com.

SOT23-5L mechanical data

Dim.	mm.			mils.		
	Min.	Typ.	Max.	Min.	Typ.	Max.
A	0.90		1.45	35.4		57.1
A1	0.00		0.10	0.0		3.9
A2	0.90		1.30	35.4		51.2
b	0.35		0.50	13.7		19.7
C	0.09		0.20	3.5		7.8
D	2.80		3.00	110.2		118.1
E	1.50		1.75	59.0		68.8
e		0.95			37.4	
H	2.60		3.00	102.3		118.1
L	0.10		0.60	3.9		23.6

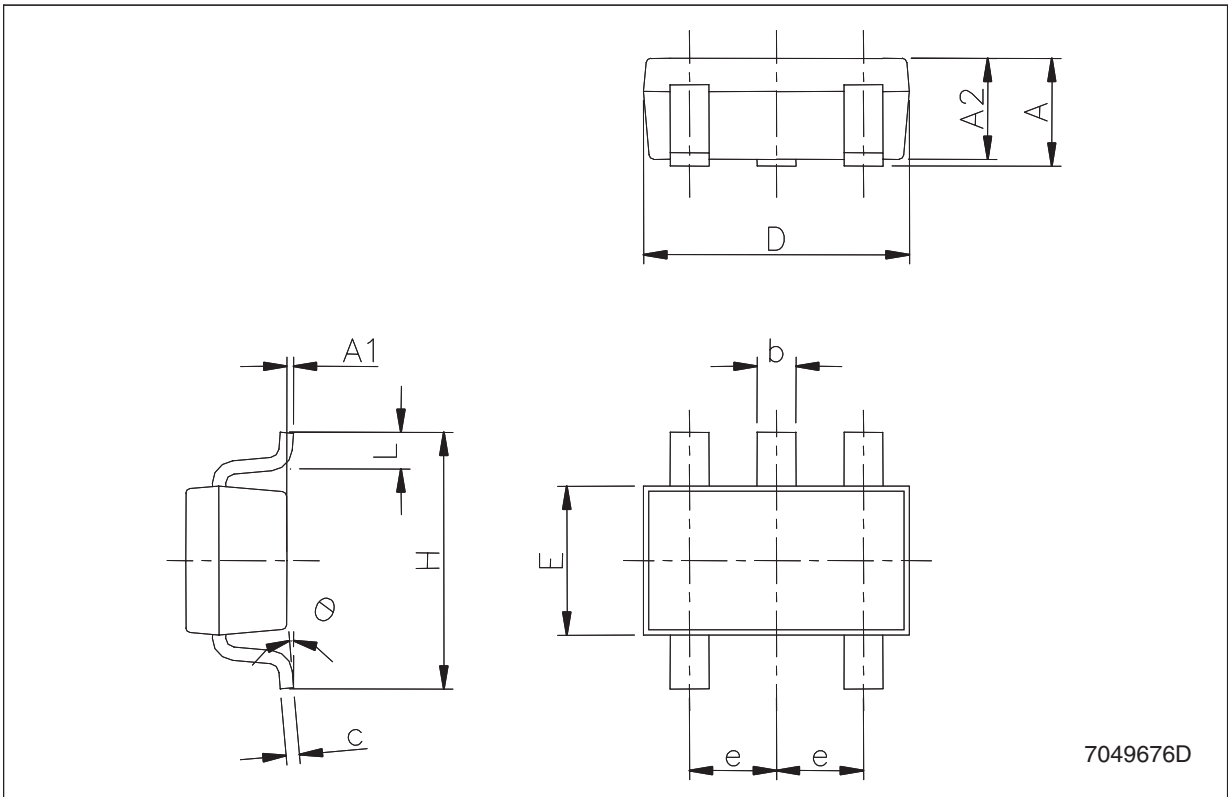

Tape & reel SOT23-xL mechanical data

Dim.	mm.			inch.		
	Min.	Typ.	Max.	Min.	Typ.	Max.
A			180			7.086
C	12.8	13.0	13.2	0.504	0.512	0.519
D	20.2			0.795		
N	60			2.362		
T			14.4			0.567
Ao	3.13	3.23	3.33	0.123	0.127	0.131
Bo	3.07	3.17	3.27	0.120	0.124	0.128
Ko	1.27	1.37	1.47	0.050	0.054	0.058
Po	3.9	4.0	4.1	0.153	0.157	0.161
P	3.9	4.0	4.1	0.153	0.157	0.161

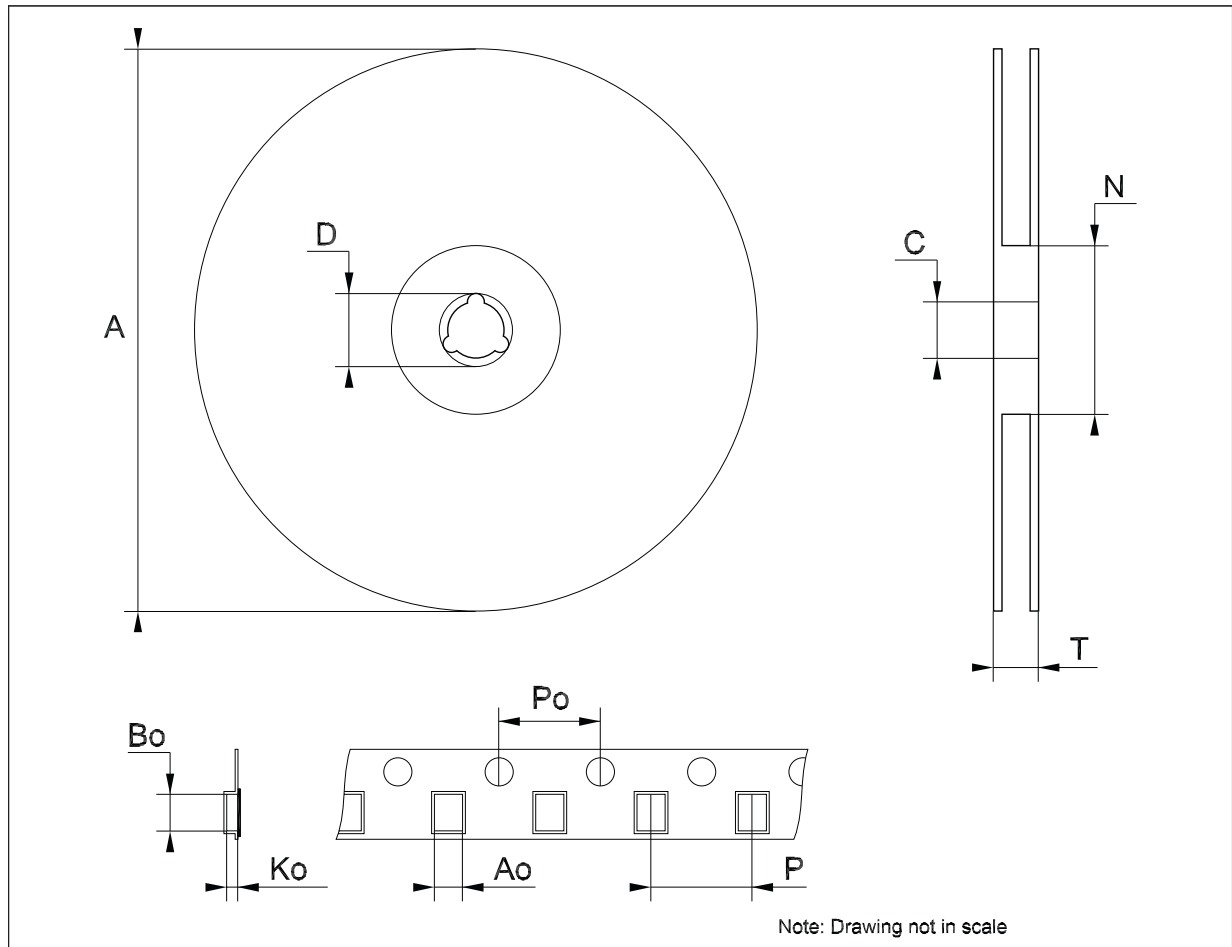

7 Order codes

Table 6. Order codes

Part number	Output voltage	V _{OUT} Min.	V _{OUT} Max.	Test voltage
LK112SM13TR ⁽¹⁾	1.3V	1.24V	1.36V	2.4V
LK112SM14TR ⁽¹⁾	1.4V	1.34V	1.46V	2.4V
LK112SM18TR	1.8V	1.74V	1.86V	2.4V
LK112SM19TR ⁽¹⁾	1.9V	1.84V	1.96V	2.4V
LK112SM20TR ⁽¹⁾	2.0V	1.94V	2.06V	3.0V
LK112SM21TR ⁽¹⁾	2.1V	2.04V	2.16V	3.1V
LK112SM22TR ⁽¹⁾	2.2V	2.14V	2.26V	3.2V
LK112SM23TR ⁽¹⁾	2.3V	2.24V	2.36V	3.3V
LK112SM24TR ⁽¹⁾	2.4V	2.34V	2.46V	3.4V
LK112SM26TR ⁽¹⁾	2.6V	2.54V	2.66V	3.6V
LK112SM28TR	2.8V	2.74V	2.86V	3.8V
LK112SM29TR ⁽¹⁾	2.9V	2.84V	2.96V	3.9V
LK112SM31TR ⁽¹⁾	3.1V	3.04V	3.16V	4.1V
LK112SM33TR	3.3V	3.24V	3.36V	4.3V
LK112SM34TR ⁽¹⁾	3.4V	3.335V	3.465V	4.4V
LK112SM35TR ⁽¹⁾	3.5V	3.435V	3.565V	4.5V
LK112SM36TR ⁽¹⁾	3.6V	3.535V	3.655V	4.6V
LK112SM37TR ⁽¹⁾	3.7V	3.630V	3.770V	4.7V
LK112SM38TR ⁽¹⁾	3.8V	3.725V	3.875V	4.8V
LK112SM39TR ⁽¹⁾	3.9V	3.825V	3.975V	4.9V
LK112SM41TR ⁽¹⁾	4.1V	4.020V	4.180V	5.1V
LK112SM42TR ⁽¹⁾	4.2V	4.120V	4.280V	5.2V
LK112SM43TR ⁽¹⁾	4.3V	4.215V	4.385V	5.3V
LK112SM44TR ⁽¹⁾	4.4V	4.315V	4.485V	5.4V
LK112SM45TR ⁽¹⁾	4.5V	4.410V	4.590V	5.5V
LK112SM46TR ⁽¹⁾	4.6V	4.510V	4.690V	5.6V
LK112SM47TR ⁽¹⁾	4.7V	4.605V	4.795V	5.7V
LK112SM48TR ⁽¹⁾	4.8V	4.705V	4.895V	5.8V
LK112SM49TR ⁽¹⁾	4.9V	4.800V	5.000V	5.9V
LK112SM50TR	5.0V	4.900V	5.100V	6.0V

1. Available on request.

8 Revision history

Table 7. Document revision history

Date	Revision	Changes
31-Aug-2004	3	Mistake on fig. 19.
31-Jan-2005	4	Change maturity code.
12-Jun-2006	5	Order codes updated.
17-Oct-2006	6	The T _{OP} value on table 2 updated.
20-Jul-2007	7	Add Table 1 in cover page.
21-Sep-2007	8	Features updated.
11-Dec-2007	9	Modified: Table 6 .
12-Feb-2008	10	Modified: Table 6 on page 15 .
10-Jul-2008	11	Modified: Table 1 on page 1 and Table 6 on page 15 .

Please Read Carefully:

Information in this document is provided solely in connection with ST products. STMicroelectronics NV and its subsidiaries ("ST") reserve the right to make changes, corrections, modifications or improvements, to this document, and the products and services described herein at any time, without notice.

All ST products are sold pursuant to ST's terms and conditions of sale.

Purchasers are solely responsible for the choice, selection and use of the ST products and services described herein, and ST assumes no liability whatsoever relating to the choice, selection or use of the ST products and services described herein.

No license, express or implied, by estoppel or otherwise, to any intellectual property rights is granted under this document. If any part of this document refers to any third party products or services it shall not be deemed a license grant by ST for the use of such third party products or services, or any intellectual property contained therein or considered as a warranty covering the use in any manner whatsoever of such third party products or services or any intellectual property contained therein.

UNLESS OTHERWISE SET FORTH IN ST'S TERMS AND CONDITIONS OF SALE ST DISCLAIMS ANY EXPRESS OR IMPLIED WARRANTY WITH RESPECT TO THE USE AND/OR SALE OF ST PRODUCTS INCLUDING WITHOUT LIMITATION IMPLIED WARRANTIES OF MERCHANTABILITY, FITNESS FOR A PARTICULAR PURPOSE (AND THEIR EQUIVALENTS UNDER THE LAWS OF ANY JURISDICTION), OR INFRINGEMENT OF ANY PATENT, COPYRIGHT OR OTHER INTELLECTUAL PROPERTY RIGHT.

UNLESS EXPRESSLY APPROVED IN WRITING BY AN AUTHORIZED ST REPRESENTATIVE, ST PRODUCTS ARE NOT RECOMMENDED, AUTHORIZED OR WARRANTED FOR USE IN MILITARY, AIR CRAFT, SPACE, LIFE SAVING, OR LIFE SUSTAINING APPLICATIONS, NOR IN PRODUCTS OR SYSTEMS WHERE FAILURE OR MALFUNCTION MAY RESULT IN PERSONAL INJURY, DEATH, OR SEVERE PROPERTY OR ENVIRONMENTAL DAMAGE. ST PRODUCTS WHICH ARE NOT SPECIFIED AS "AUTOMOTIVE GRADE" MAY ONLY BE USED IN AUTOMOTIVE APPLICATIONS AT USER'S OWN RISK.

Resale of ST products with provisions different from the statements and/or technical features set forth in this document shall immediately void any warranty granted by ST for the ST product or service described herein and shall not create or extend in any manner whatsoever, any liability of ST.

ST and the ST logo are trademarks or registered trademarks of ST in various countries.

Information in this document supersedes and replaces all information previously supplied.

The ST logo is a registered trademark of STMicroelectronics. All other names are the property of their respective owners.

© 2008 STMicroelectronics - All rights reserved

STMicroelectronics group of companies

Australia - Belgium - Brazil - Canada - China - Czech Republic - Finland - France - Germany - Hong Kong - India - Israel - Italy - Japan - Malaysia - Malta - Morocco - Singapore - Spain - Sweden - Switzerland - United Kingdom - United States of America

www.st.com