

FIG. 83a

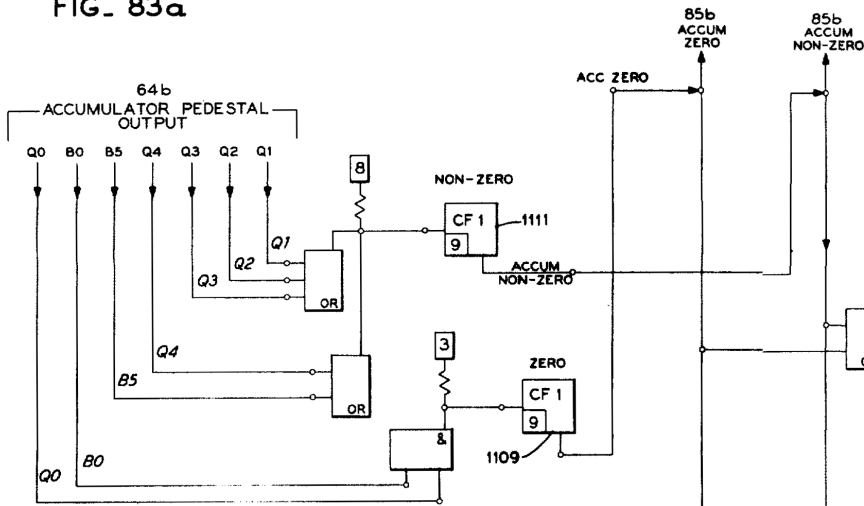

FIG. 83b

