

DE0-Nano-SoC

MY FIRST HPS

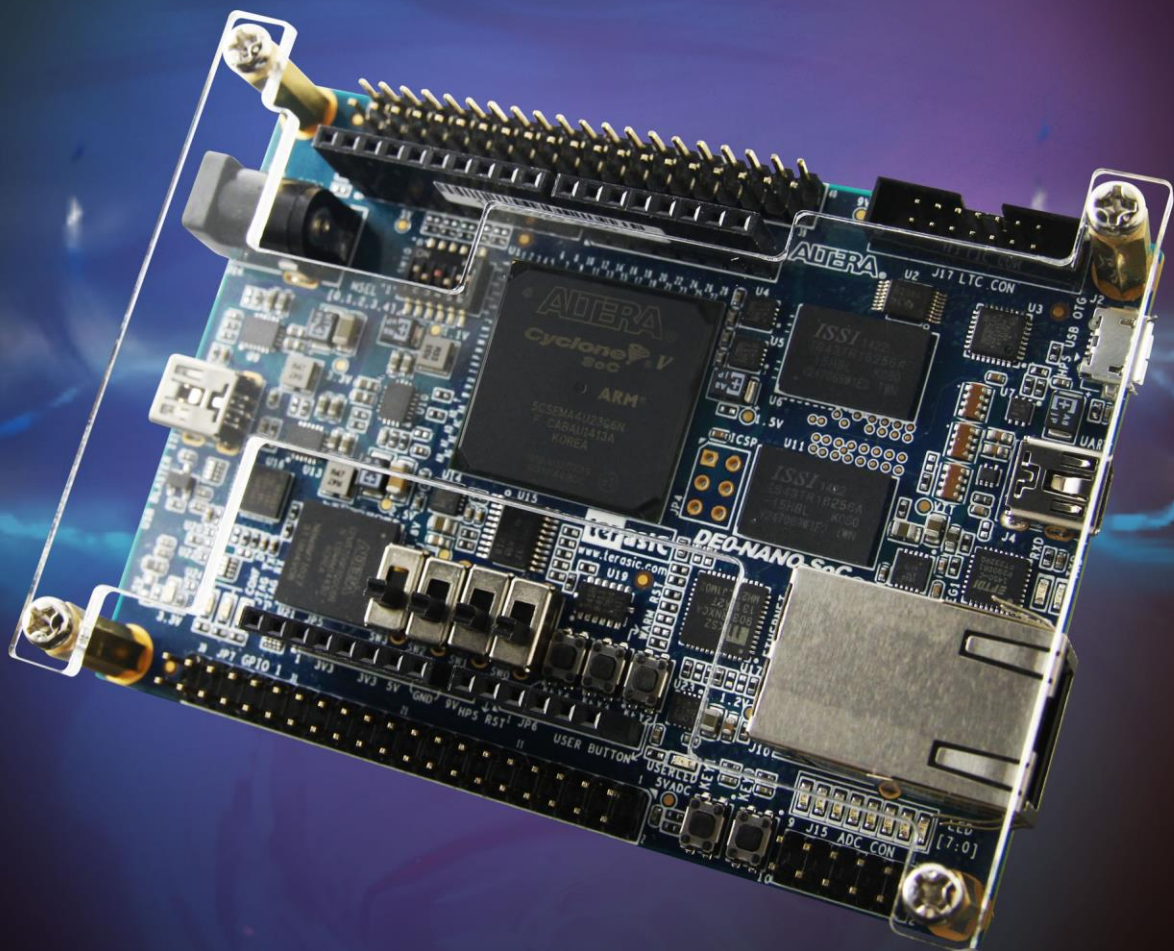

terasic
www.terasic.com

ALTERA
UNIVERSITY
PROGRAM

Copyright © 2003-2015 Terasic Inc. All Rights Reserved.

Chapter 1	<i>Introduction</i>	1
1.1	Design Flow	1
1.2	Before You Begin	2
1.3	What You Will Learn	6
Chapter 2	<i>Assign The Device</i>	7
2.1	Assign The Device	7
Chapter 3	<i>Design Entry</i>	11
3.1	Add a PLL Megafunction	11
3.2	Add a Multiplexer	26
3.3	Assign the Pins	33
3.4	Create a Default TimeQuest SDC File	35
Chapter 4	<i>Compile and Verify Your Design</i>	37
4.1	Compile Your Design	37
4.2	Program the FPGA Device	39
4.3	Verify The Hardware	45
Chapter 5	<i>Appendix</i>	48
5.1	Headquarter & Branches	48

This tutorial provides comprehensive information that will help you understand how to create a FPGA design and run it on your DE0-Nano-SoC development board. The following sections provide a quick overview of the design flow, explain what you need to get started, and describe what you will learn.

1.1 Design Flow

Figure 1-1 shows the FPGA design flow block diagram.

The standard FPGA design flow starts with design entry using schematics or a hardware description language (HDL), such as Verilog HDL or VHDL. In this step, you can create a digital circuit that is implemented inside the FPGA. The flow then proceeds through compilation, simulation, programming, and verification in the FPGA hardware.

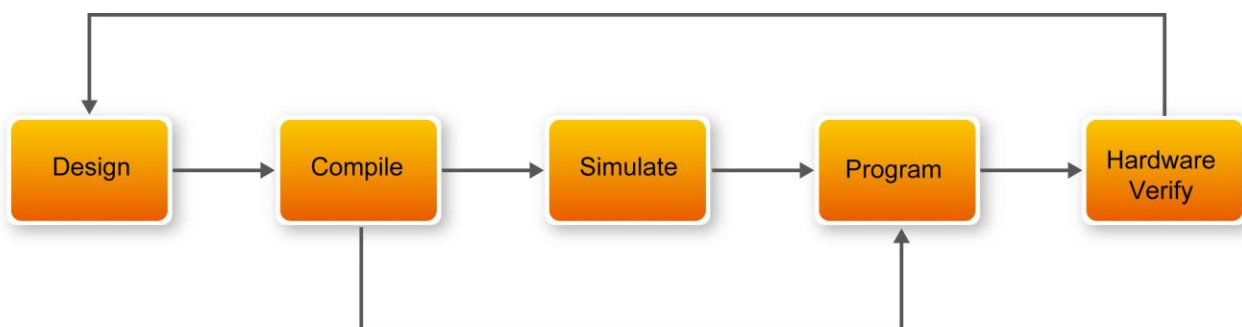

Figure 1-1 Design Flow

This tutorial guides you through all of the steps except for simulation. Although it is not covered in this document, simulation is very important to learn, and there are entire applications devoted to simulating hardware designs. There are two types of simulation, Functional and Timing. Functional simulation allows you to verify that your code is manipulating the inputs and outputs appropriately. Timing (or post place-and-route) simulation verifies that the design meets timing and functions appropriately in the device.

1.2 Before You Begin

This tutorial assumes the following prerequisites

- You generally know what a FPGA is. This tutorial does not explain the basic concepts of programmable logic.
- You are somewhat familiar with digital circuit design and electronic design automation (EDA) tools.
- You have installed the Altera Quartus II 14.1 software on your computer. If you do not have the Quartus II software, you can download it from the Altera web site at www.altera.com/download.
- You have a DE0-Nano-SoC Development Board on which you will test your project. Using a development board helps you to verify whether your design is really working.
- You have gone through the quick start guide and/or the getting started user guide for your development kit. These documents ensure that you have:
 - Installed the required software.
 - Determined that the development board functions properly and is connected to your computer.

Next step you should installed the USB-BlasterII driver, Plug in the 5-volt adapter to provide power to the board. Use the USB cable to connect the leftmost USB connector on the DE0-NANO-SoC board to a USB port on a computer that runs the Quartus II software. Turn on the power switch on the DE0-NANO-SoC board.

The computer will recognize the new hardware connected to its USB port and Power on the board as shown in **Figure 1-2**, but it will be unable to proceed if it does not have the required driver already installed. The DE0-Nano-SoC board is programmed by using Altera USB-Blaster II mechanism. If the USB-BlasterII driver is not already installed, the Driver Software Installation in **Figure 1-3** will appear. Click close.

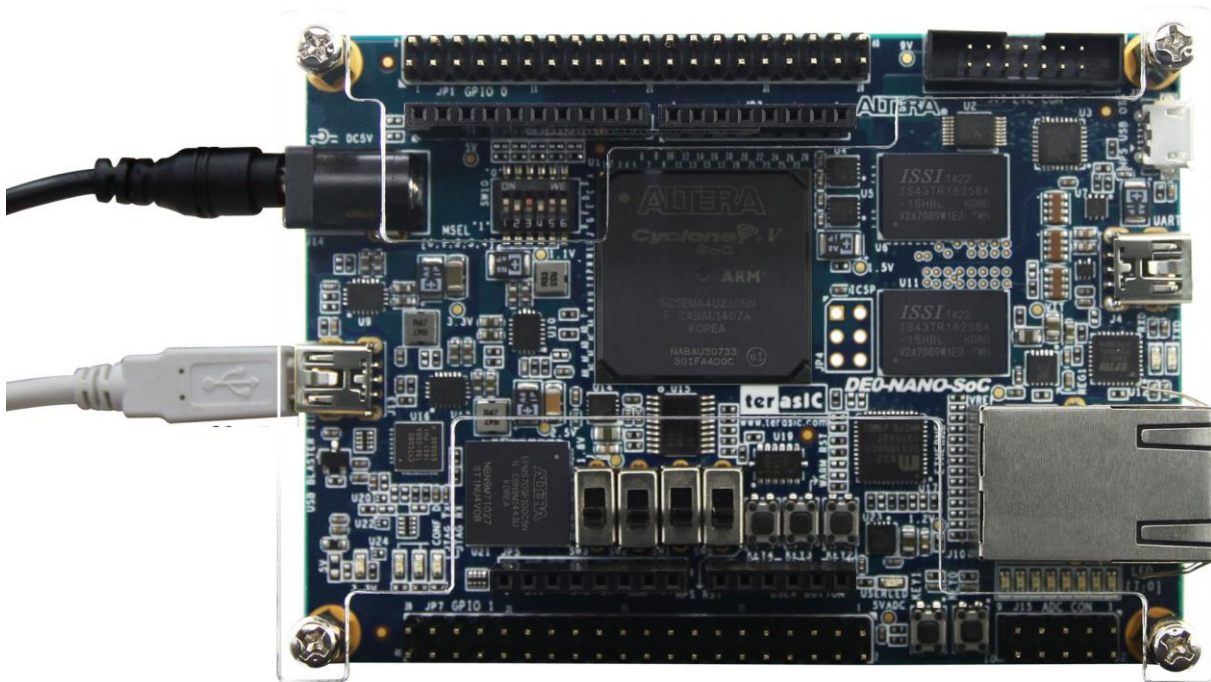

Figure 1-2 Connection Setup

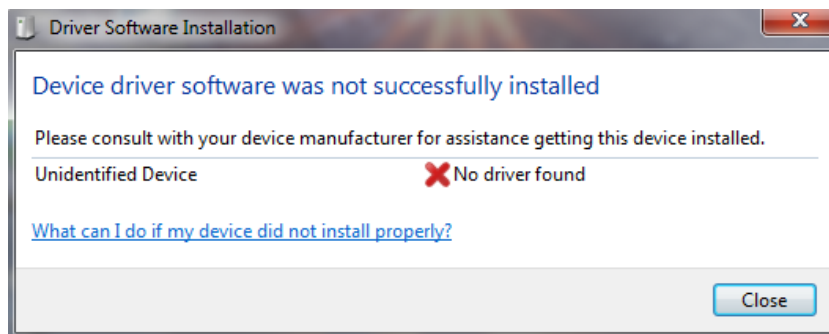

Figure 1-3 Driver Software Installation

Since the desired driver is not available on the Windows Update Web site, open the Computer Management and select the Device Manager. This leads to the window in **Figure 1-4**.

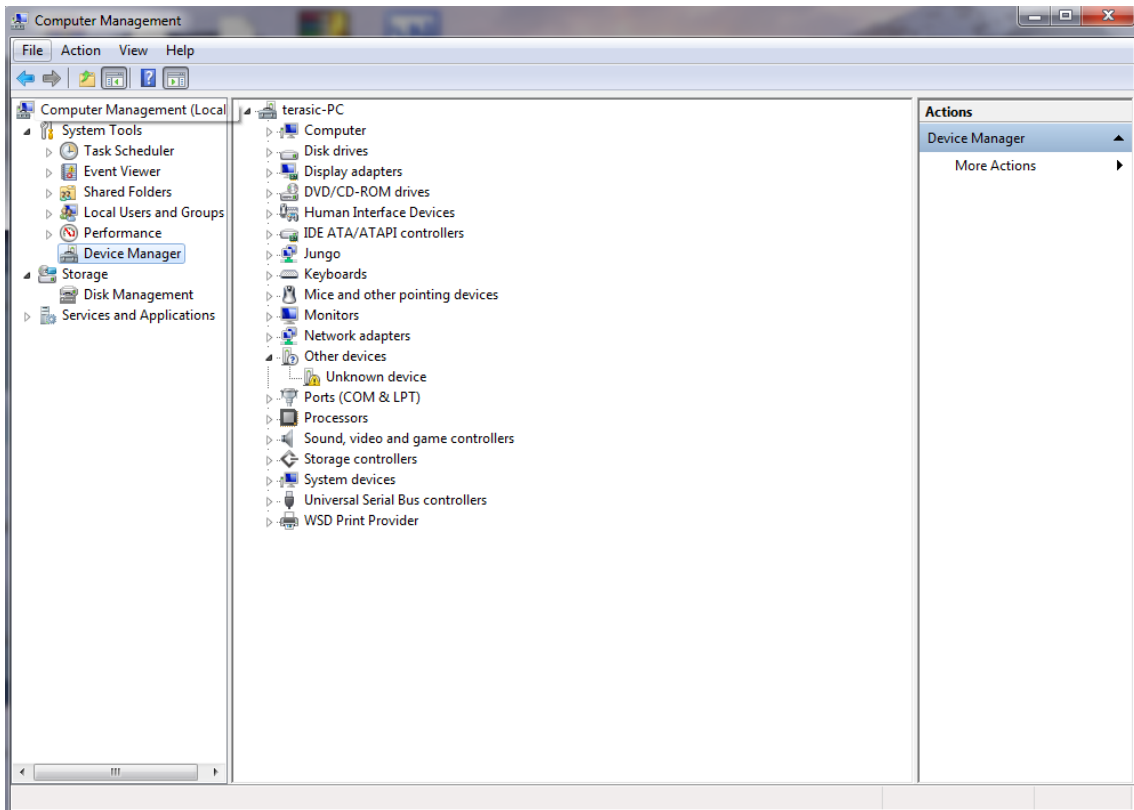

Figure 1-4 Device Manager

Right click Other devices>Unknown device and select Update Driver Software... This leads to the window in Figure 1-5.

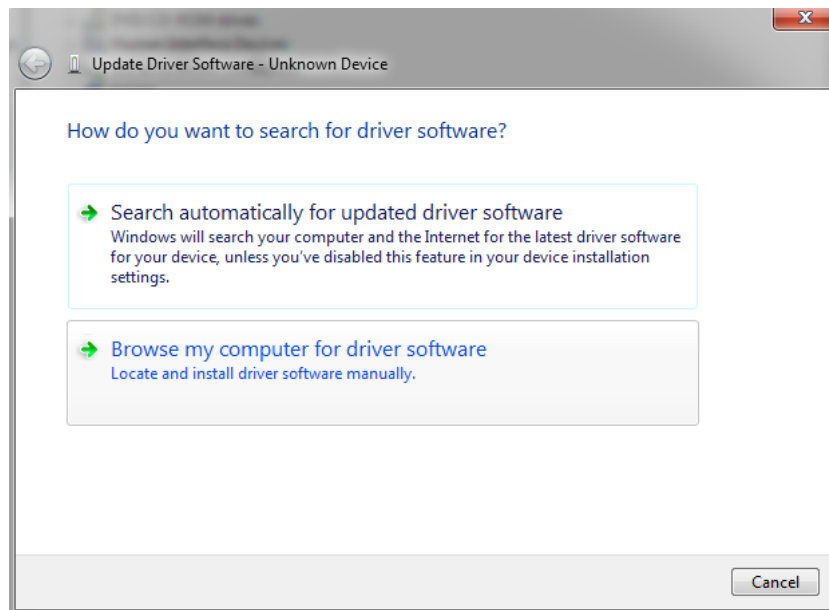

Figure 1-5 Update Driver Software

The driver is available within the Quartus II software. Hence, click Browse my computer for device software to get to **Figure 1-6**.

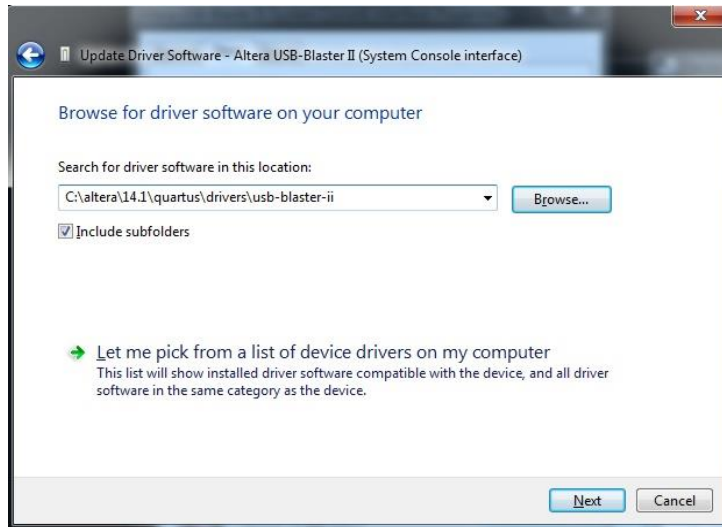

Figure 1-6 Specify the location of the driver

Now, click Browse to get to the pop-up box in **Figure 1-7** Find the desired driver, which is at location C:\altera\14.1\quartus\drivers\usb-blaster-ii. Click OK and then upon returning to Figure 1-6.click Next.

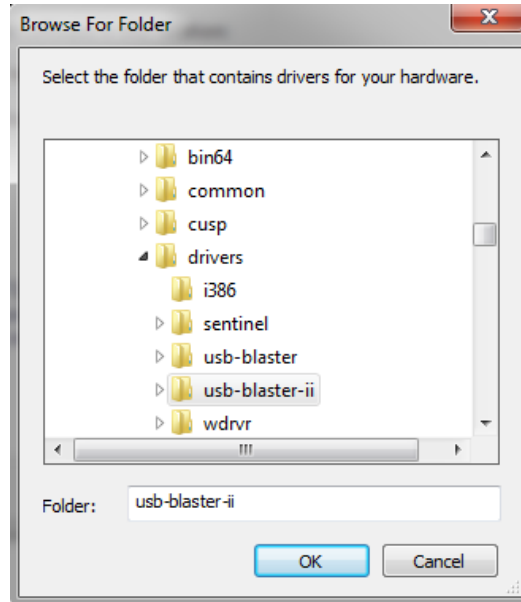

Figure 1-7 Browse to find the location

The driver will now be installed as indicated in **Figure 1-8** Click close and you can start using the DE0-Nano-SoC board.

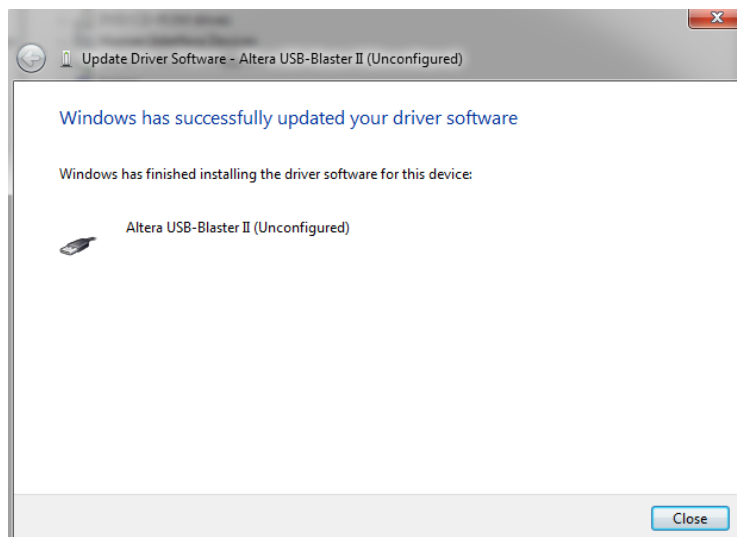

Figure 1-8 The driver is installed

1.3 What You Will Learn

In this tutorial you will perform the following tasks:

Create a design that causes LEDs on the development board to blink at a speed that is controlled by an input key — This design is easy to create and gives you visual feedback that the design works. Of course, you can use your DE0-Nano-SoC board to run other designs as well. For the LED design, you will write Verilog HDL code for a simple 32-bit counter, add a phase-locked loop (PLL) megafunction as the clock source, and add a 2-input multiplexer megafunction. When the design is running on the board, you can press an input switch to multiplex the counter bits that drive the output LEDs.

Becoming familiar with Quartus II design tools—This tutorial will not make you an expert, but at the end, you will understand basic concepts about Quartus II projects, such as entering a design using a schematic editor and HDL, compiling your design, and downloading it into the FPGA on your DE0-Nano-SoC development board.

Develop a foundation to learn more about FPGAs — For example, you can create and download digital signal processing (DSP) functions onto a single chip, or build a multi-processor system, or create anything else you can imagine all on the same chip. You don't have to scour data books to find the perfect logic device or create your own ASIC. All you need is your computer, your imagination, and an DE0-Nano-SoC FPGA development board.

Assign The Device

You begin this tutorial by creating a new Quartus II project. A project is a set of files that maintain information about your FPGA design. The Quartus II Settings File (.qsf) and Quartus II Project File (.qpf) files are the primary files in a Quartus II project. To compile a design or make pin assignments, you must first create a project.

2.1 Assign The Device

1. In the Quartus II software, select File > New Project Wizard. The Introduction page opens. See **Figure 2-1**.

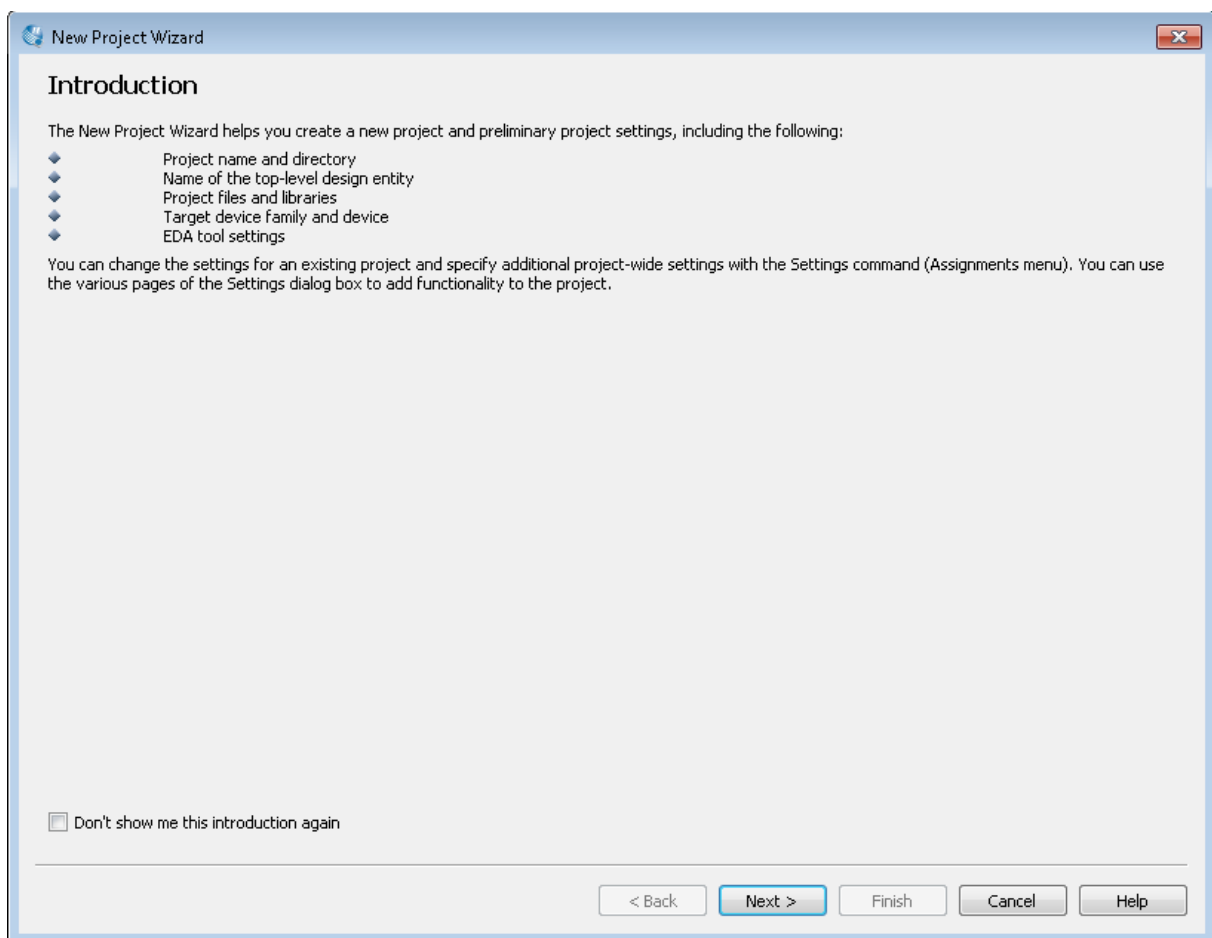

Figure 2-1 New Project Wizard introduction

2. Click Next.
3. Enter the following information about your project:
 - a. What is the working directory for this project? Enter a directory in which you will store your Quartus II project files for this design.
 - b. For example, C:\My_design\my_first_fpga.
 - c. File names, project names, and directories in the Quartus II software cannot contain spaces.
 - d. What is the name of this project? Type my_first_fpga.
 - e. What is the name of the top-level design entity for this project? Type my_first_fpga. See **Figure 2-2**.

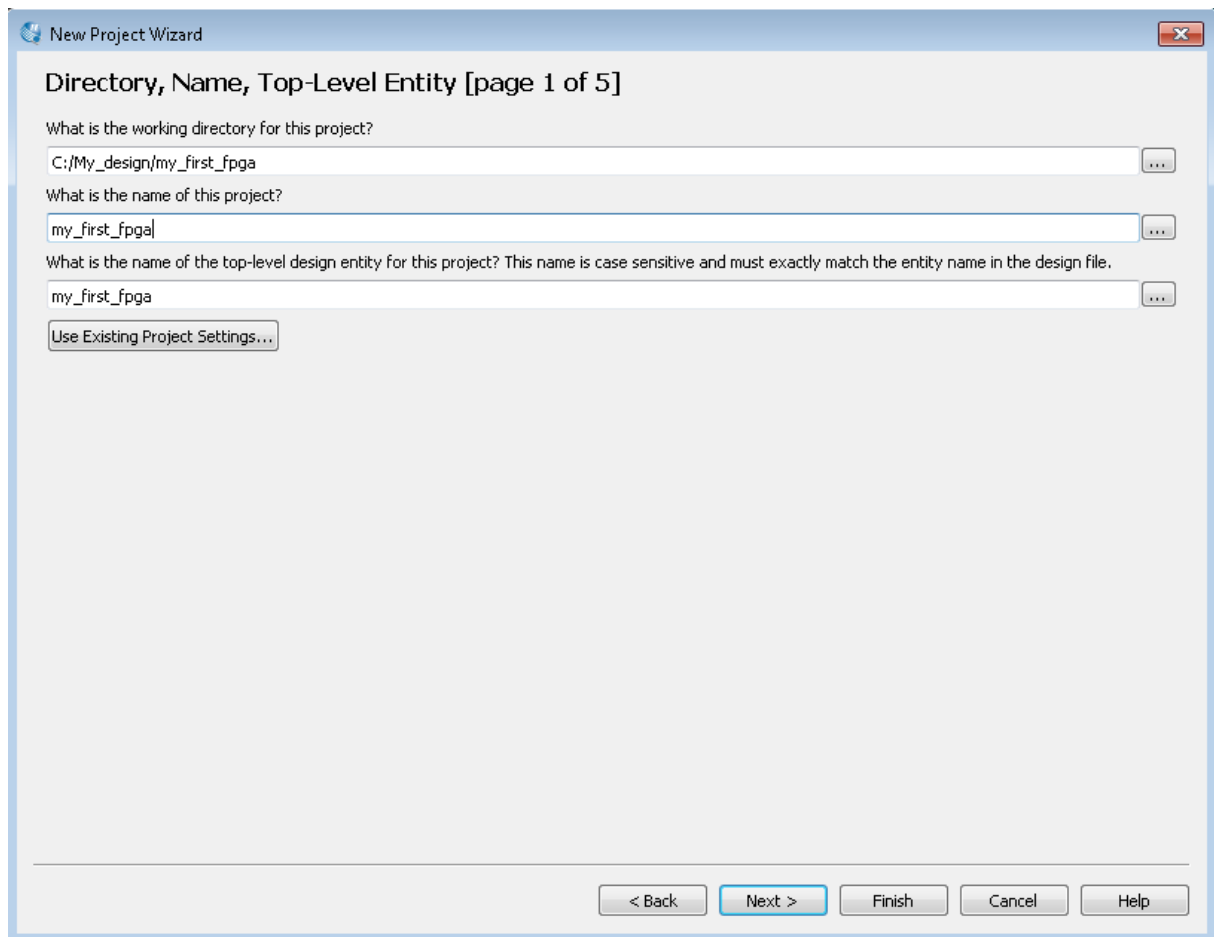

Figure 2-2 Project information

- f. Click Next.

g. You will assign a specific FPGA device to the design and make pin assignments. See [Figure 2-3](#).

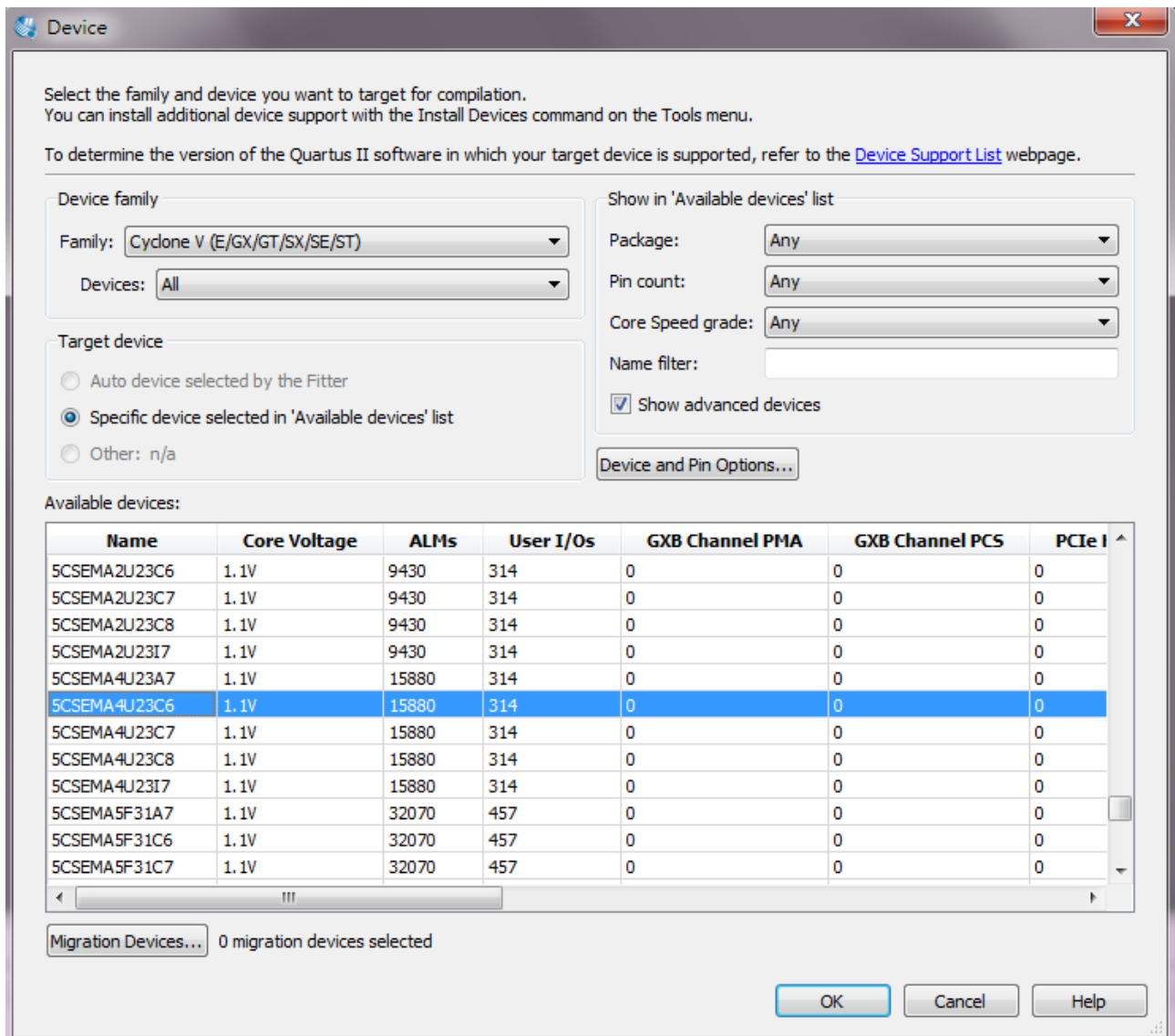

Figure 2-3 Specify the Device Example

h. Click Finish.

4. When prompted, choose Yes to create the my_first_fpga project directory. You just created your first Quartus II FPGA project. See [Figure 2-4](#).

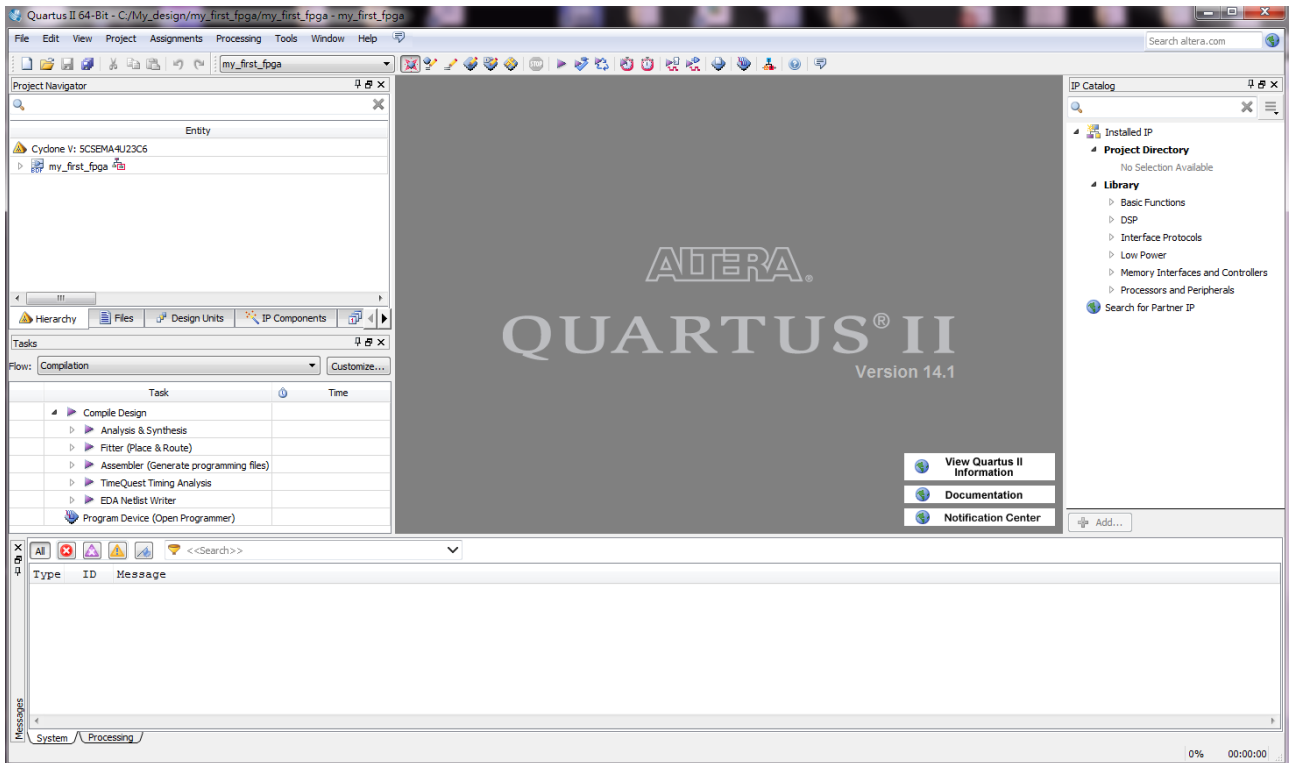

Figure 2-4 my_first_fpga project

3.1 Add a PLL Megafunction

This section describes How to Add a PLL Megafunction

In the design entry step you create a schematic or Block Design File (.bdf) that is the top-level design. You will add library of parameterized modules (LPM) functions and use Verilog HDL code to add a logic block. When creating your own designs, you can choose any of these methods or a combination of them.

1. Choose File > New > Block Diagram/Schematic File (see **Figure 3-1** to create a new file, Block1.bdf, which you will save as the top-level design.

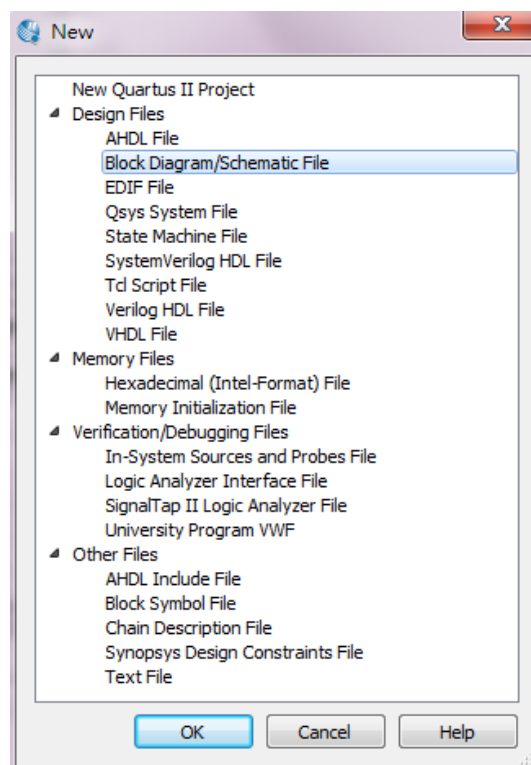

Figure 3-1 New BDF

2. Click OK.

3. Choose File > Save As and enter the following information.

- File name: my_first_fpga
- Save as type: Block Diagram/Schematic File (*.bdf)

4. Click Save. The new design file appears in the Block Editor (see **Figure 3-2**).

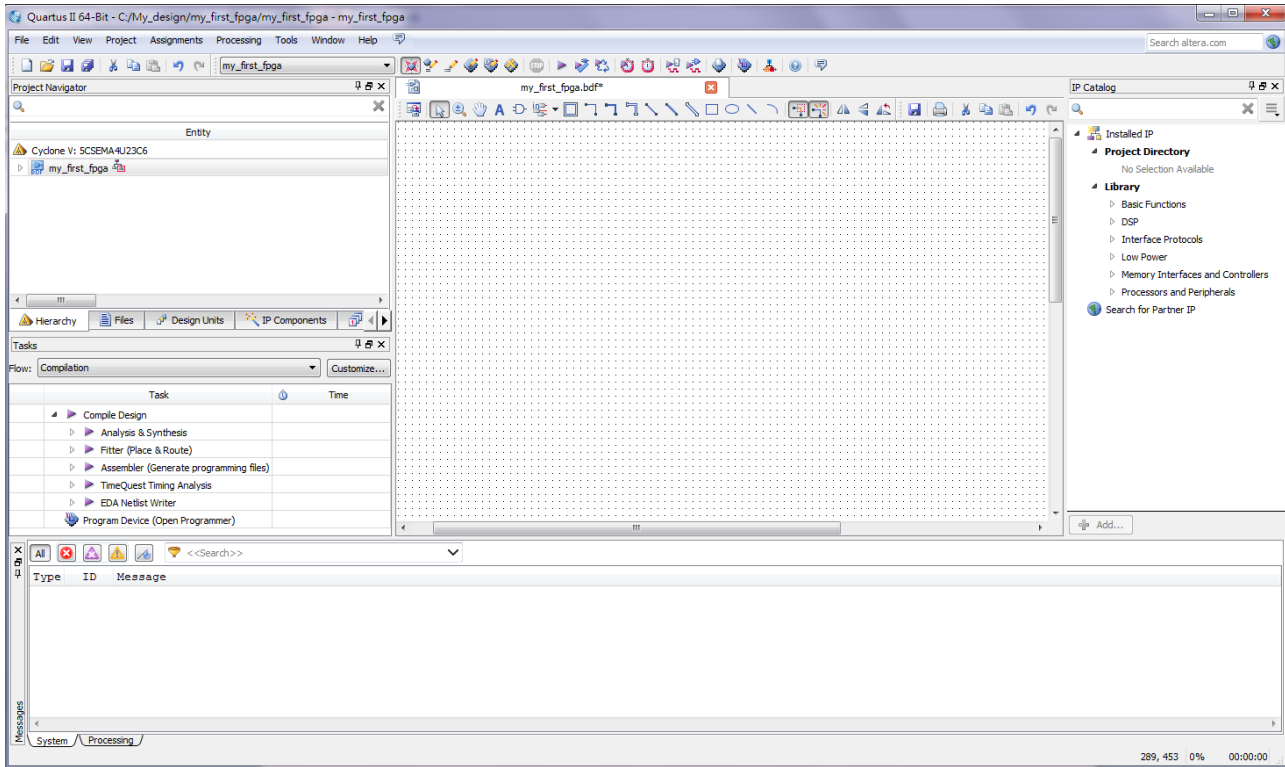

Figure 3-2 Bank BDF

5. Add HDL code to the blank block diagram by choosing File > New > Verilog HDL File.

6. Click OK to create a new file Verilog1.v, which you will save as simple_counter.v.

7. Select File > Save As and enter the following information (see **Figure 3-3**).

- File name: simple_counter.v
- Save as type: Verilog HDL File (*.v, *.vlg, *.verilog)

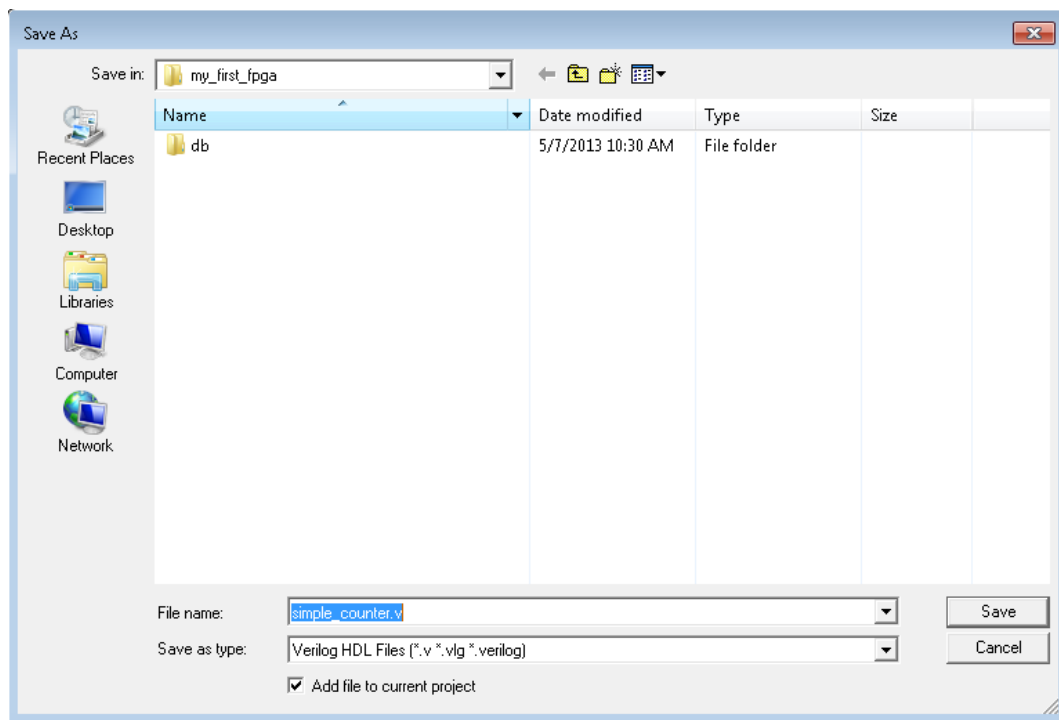

Figure 3-3 Saving the Verilog HDL file

The resulting empty file is ready for you to enter the Verilog HDL code.

8. Type the following Verilog HDL code into the blank `simple_counter.v` file (see **Figure 3-4** The Verilog File of `simple_counter.v`).

```
//It has a single clock input and a 32-bit output port

module simple_counter (
                                CLOCK_50,
                                counter_out
                                );

input  CLOCK_50 ;

output [31:0] counter_out;

reg     [31:0] counter_out;

always @ (posedge CLOCK_50)           // on positive clock edge
```

```

begin

counter_out <= #1 counter_out + 1; // increment counter

end

endmodule                                     // end of module counter

```

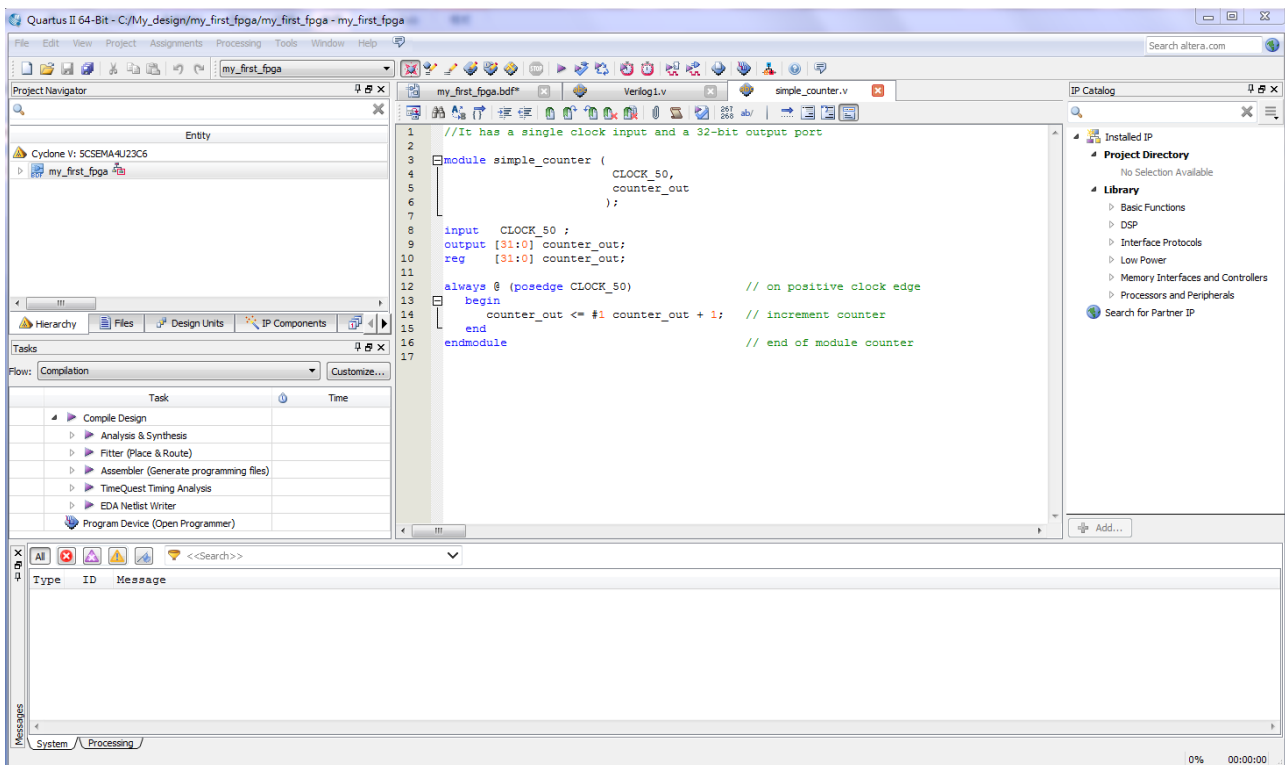

Figure 3-4 The Verilog File of simple_counter.v

9. Save the file by choosing File > Save, pressing Ctrl + s, or by clicking the floppy disk icon.
10. Choose File > Create/Update > Create Symbol Files for Current File to convert the simple_counter.v file to a Symbol File (.sym). You use this Symbol File to add the HDL code to your BDF schematic.

The Quartus II software creates a Symbol File and displays a message (see **Figure 3-5**).

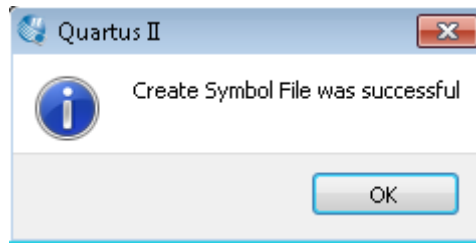

Figure 3-5 Create Symbol File was Successful

11. Click OK.
12. To add the simple_counter.v symbol to the top-level design, click the my_first_fpga.bdf tab.
13. Insert Symbol or click Add Symbol on the toolbar.
14. Double-click the Project directory to expand it.
15. Select the newly created simple_counter symbol by clicking it's icon.

You can also double-click in a blank area of the BDF to open the Symbol dialog box (see [Figure 3-6](#)).

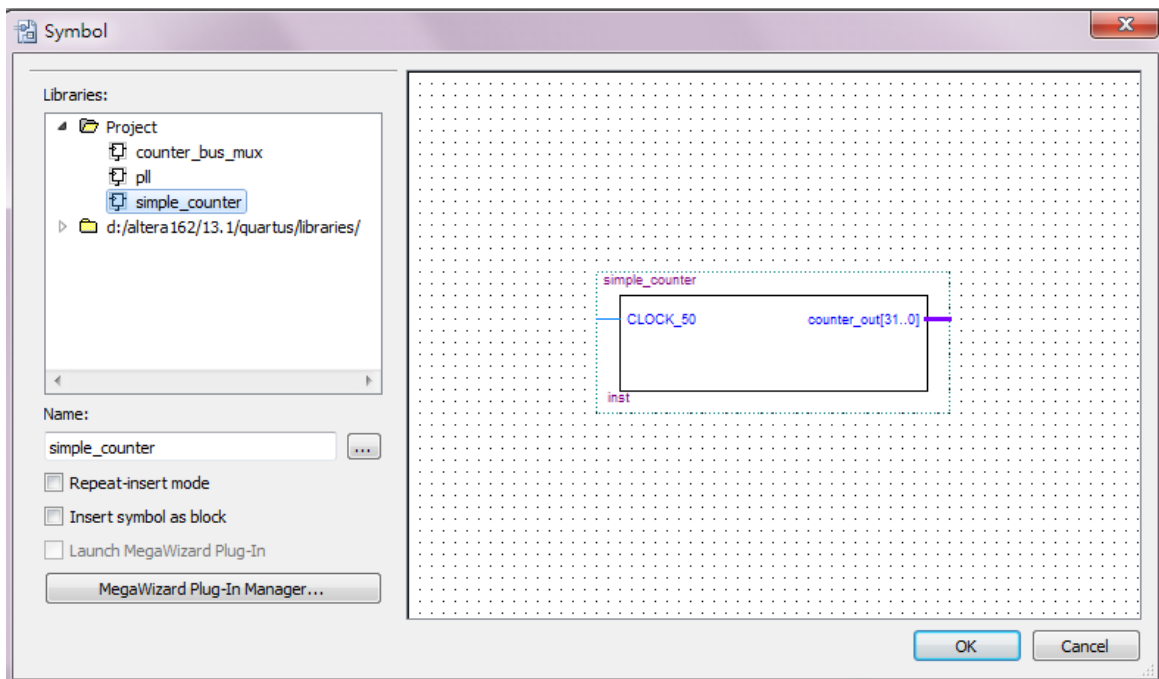

Figure 3-6 Adding the Symbol to the BDF

16. Click OK.
17. Move the cursor to the BDF grid; the symbol image moves with the cursor. Click to place the simple_counter symbol onto the BDF. You can move the block after placing it by simply clicking

and dragging it to where you want it and releasing the mouse button to place it. See **Figure 3-7**.

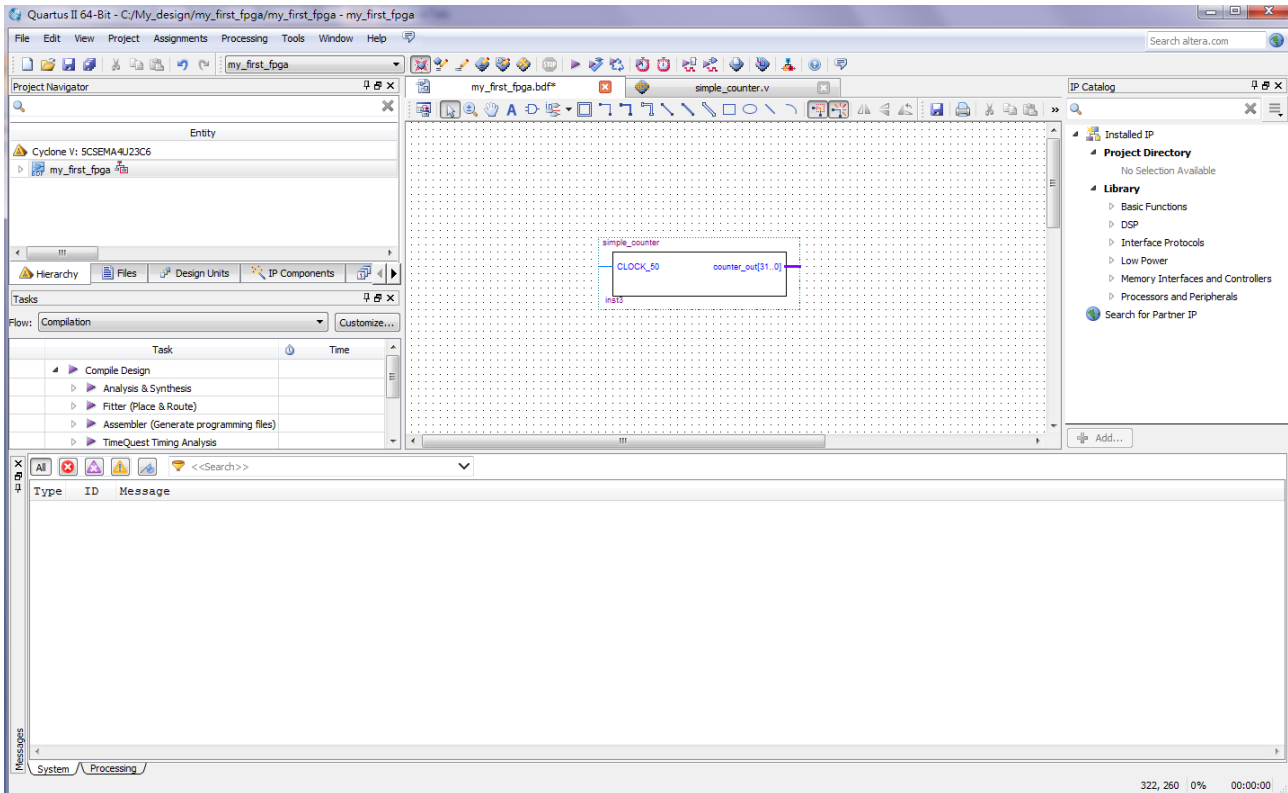

Figure 3-7 Placing the simple_counter symbol

18. Press the Esc key or click an empty place on the schematic grid to cancel placing further instances of this symbol.
19. Save your project regularly.

Using Quartus Add a PLL Megafunction.

Megafunctions, such as the ones available in the LPM, are pre-designed modules that you can use in FPGA designs. These Altera-provided megafunctions are optimized for speed, area, and device family. You can increase efficiency by using a megafunction instead of writing the function yourself. Altera also provides more complex functions, called MegaCore functions, which you can evaluate for free but require a license file for use in production designs. This tutorial design uses a PLL clock source to drive a simple counter. A PLL uses the on-board oscillator (DE0-Nano-SoC Board is 50 MHz) to create a constant clock frequency as the input to the counter. To create the clock source, you will add a pre-built LPM megafunction named Altera PLL.

1. Choose Edit > Insert Symbol or click Add Symbol on the toolbar---
2. Tools > Click IP Catalog (see **Figure 3-8**).

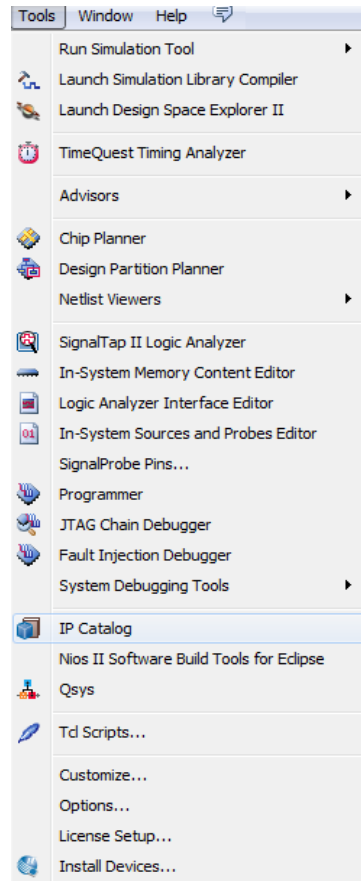

Figure 3-8 Tools Icon

3. Selecting IP Catalog.
4. Selection Altera PLL in the Library/Clocks/PLL , click "+Add" bar. See **Figure 3-9**
 - a. Under IP variation file type, Choose Verilog HDL.
 - b. Under IP variation file, Type pll.v at the end of the already create directory name.
 - c. Click OK.

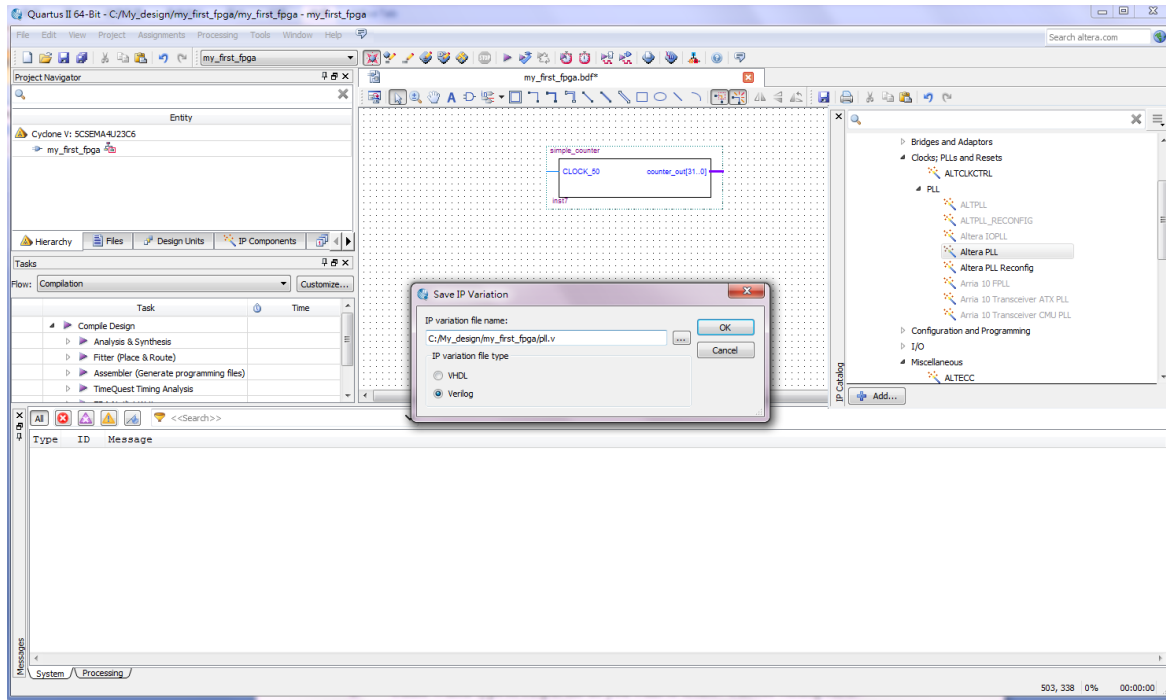

Figure 3-9 IP Catalog Selections

5. In the Altera PLL windows, make the following selections (see **Figure 3-10**).
 - a. The device speed grade choose 6 for DE0-Nano-SoC.
 - b. Set the frequency of the refclk input 50 MHz.

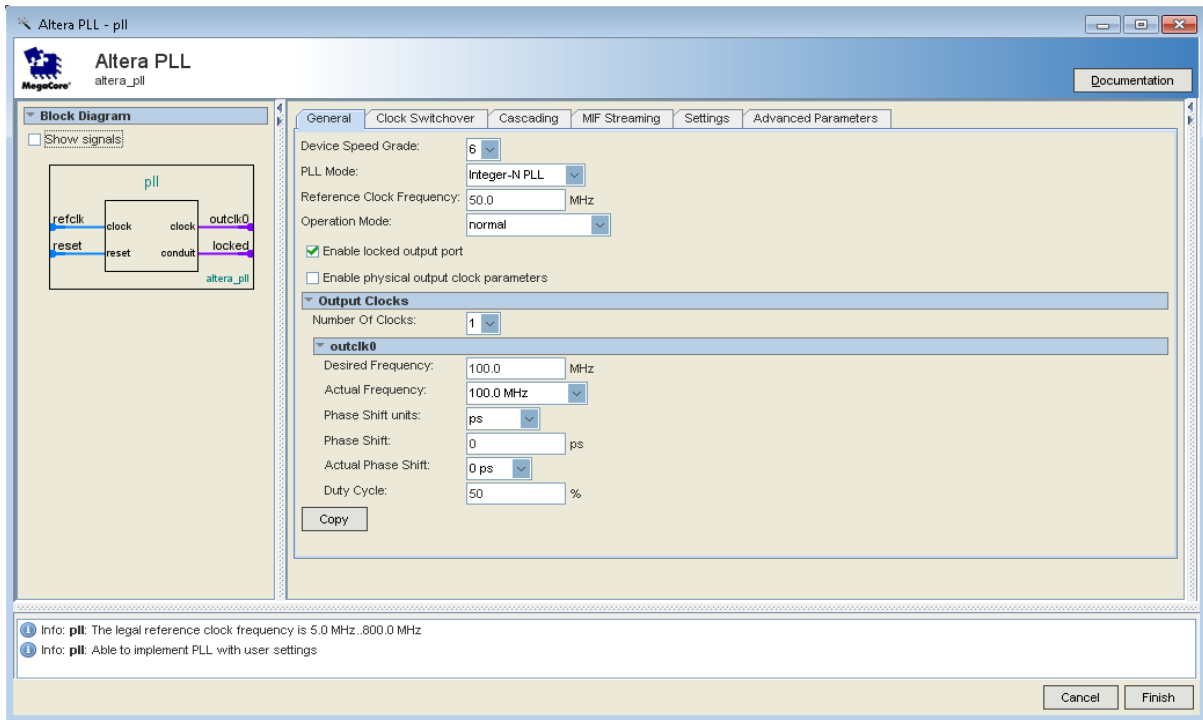

Figure 3-10 Selections of Altera PLL windows

- Turn off the Enable locked output port option on IP windows. As you turn it off, pin disappear from the PLL block’s graphical preview. See Figure 3-11 for an example.

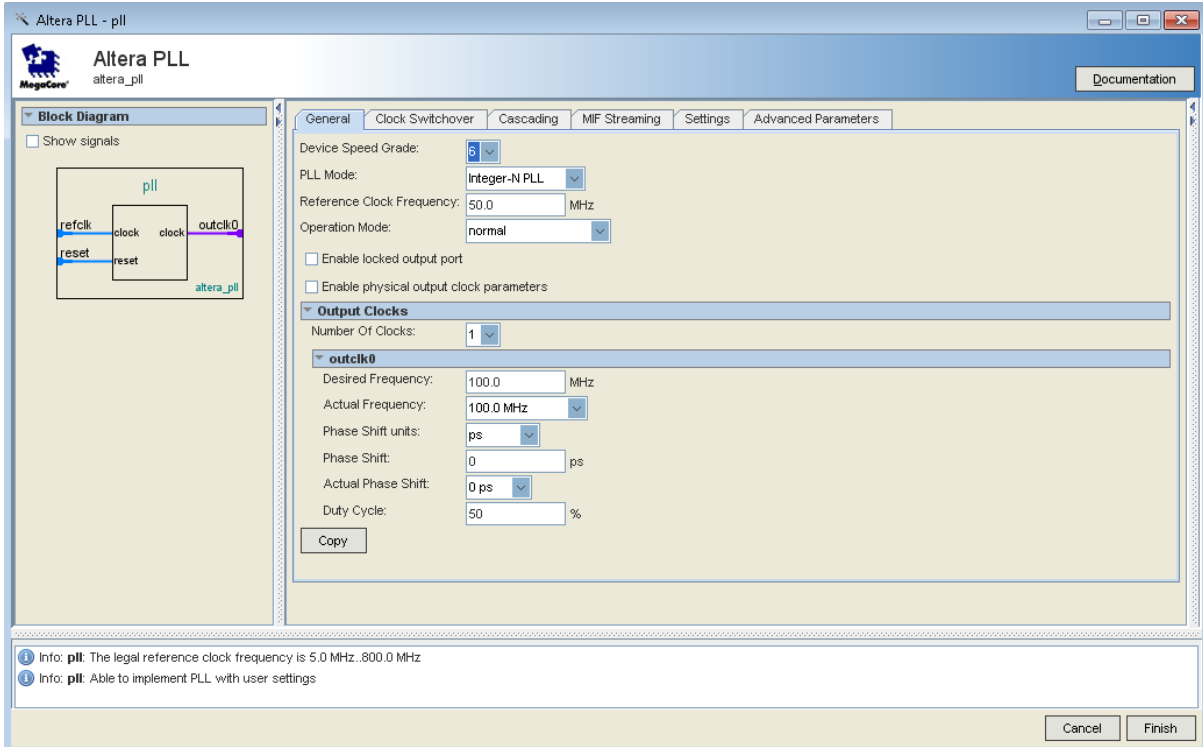

Figure 3-11 Selections of Altera PLL windows

- Then, make the following selection (see Figure 3-12).

In Desired Frequency, keyin 5.0 .

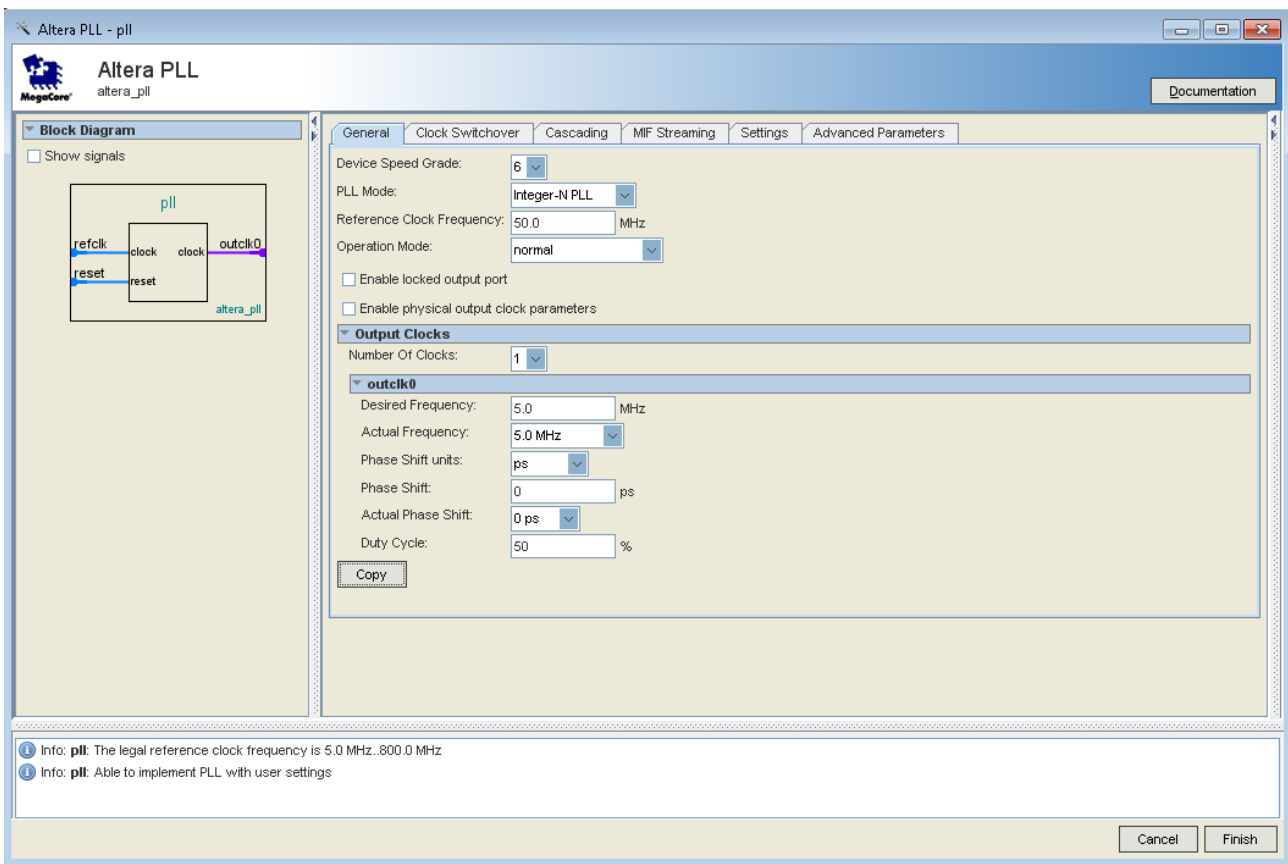

Figure 3-12 Selections of Altera PLL windows

8. Click Finish. It leads to [Figure 3-13](#). Click Exit.

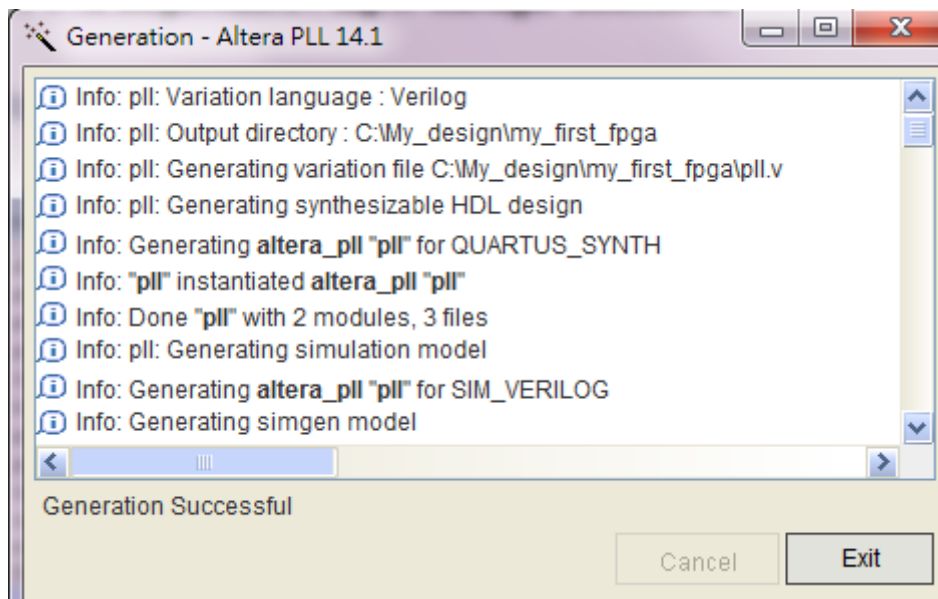

Figure 3-13 PLL Generation

9. The Symbol window opens, showing the newly created PLL megafunction. See [Figure 3-14](#).

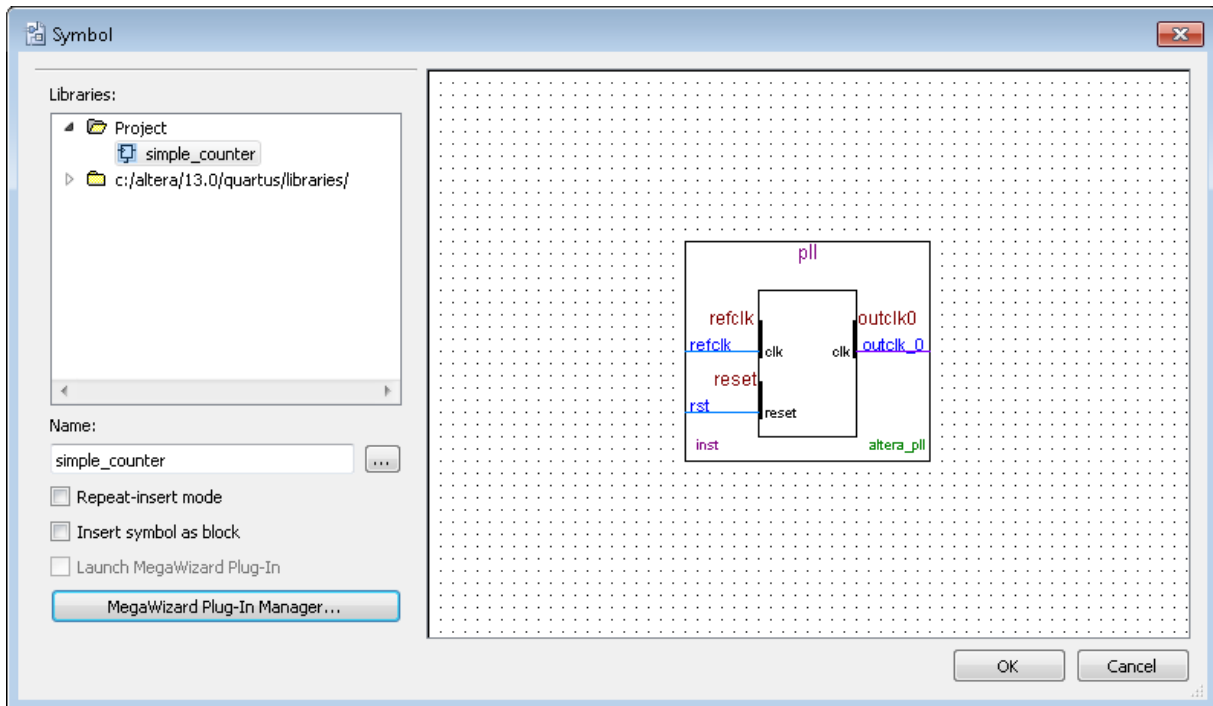

Figure 3-14 PLL Symbol

10. Click OK and place the pll symbol onto the BDF to the left of the simple_counter symbol. You can move the symbols around by holding down the left mouse button, helping you ensure that they line up properly. See Figure 3-15.

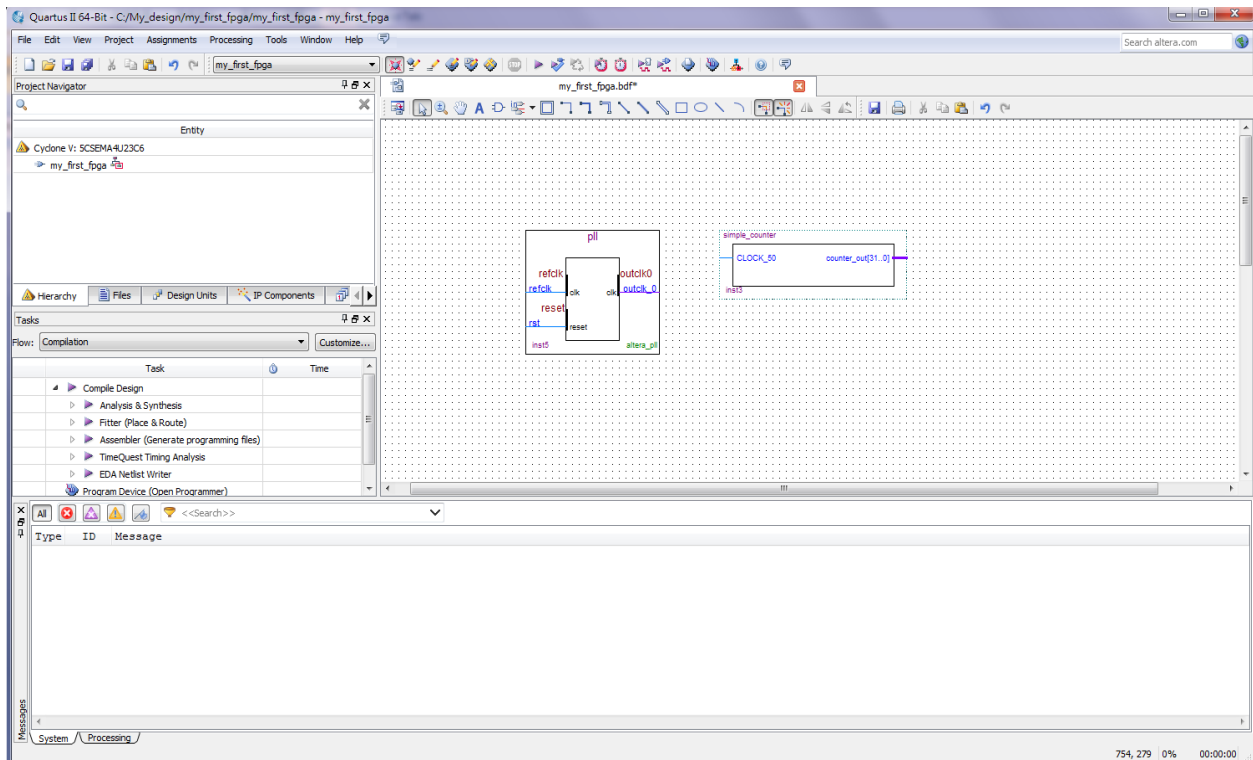

Figure 3-15 Place the PLL Symbol

11. Move the mouse so that the cursor (also called the selection tool) is over the pll symbol's outclk_0 output pin. The orthogonal node tool (cross-hair) icon appears.
12. Click and drag a bus line from the outclk_0 output to the simple_counter clock input. This action ties the pll output to the simple_counter input (see **Figure 3-16**).

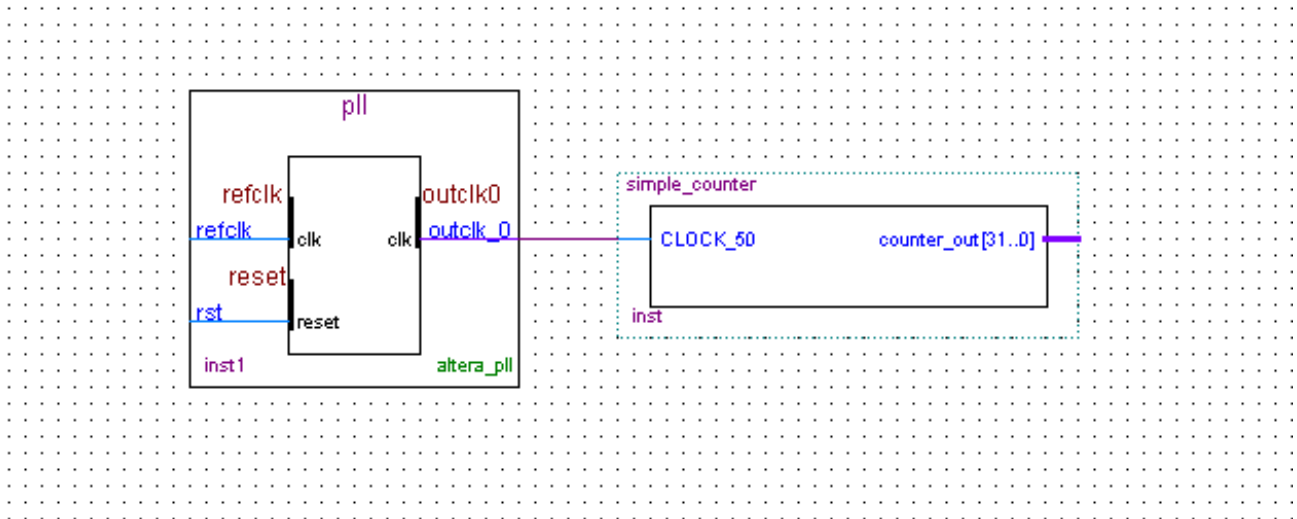

Figure 3-16 Draw a Bus Line connect pll outclk_0 port to simple_counter CLOCK_50 port

13. Add an input pin and an output bus with the following steps:
 - a. Choose Edit > Insert Symbol.
 - b. Under Libraries, select quartus/libraries > primitives > pin >input. See **Figure 3-17**
 - c. Click OK

If you need more room to place symbols, you can use the vertical and horizontal scroll bars at the edges of the BDF window to view more drawing space.

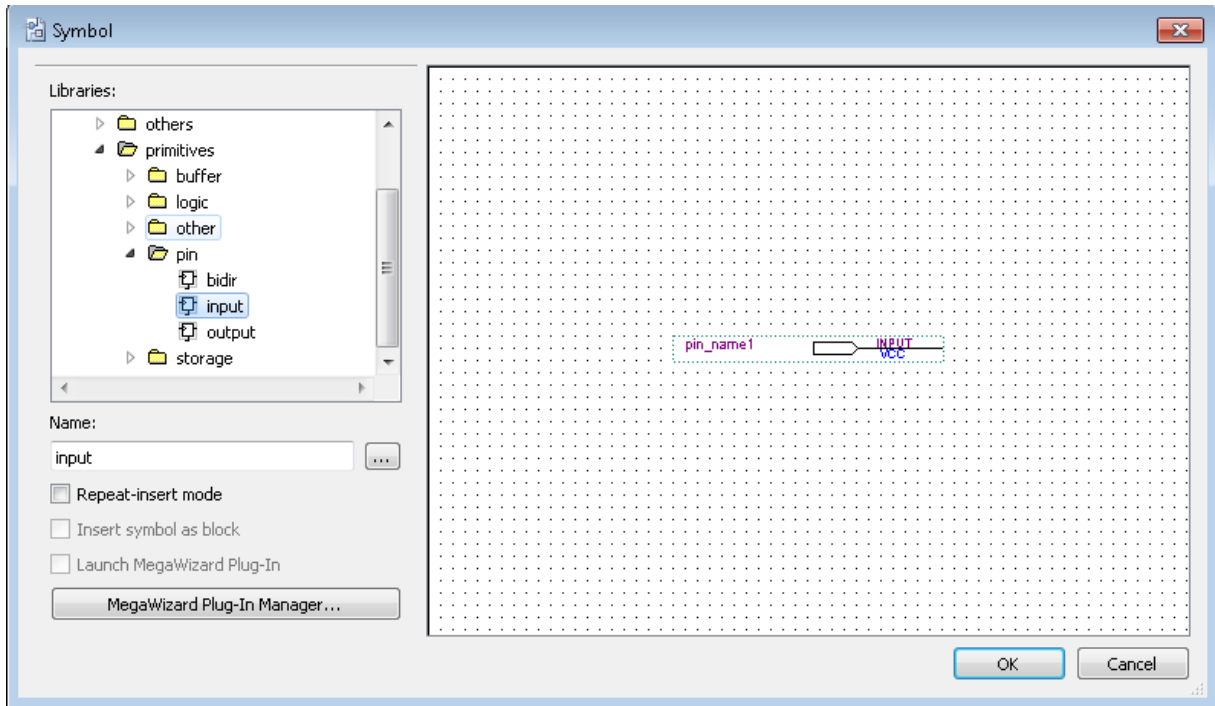

Figure 3-17 Input pin symbol

- d. Place the new pin onto the BDF so that it is touching the input to the pll symbol.
- e. Use the mouse to click and drag the new input pin to the left; notice that the ports remain connected as shown in **Figure 3-18**.

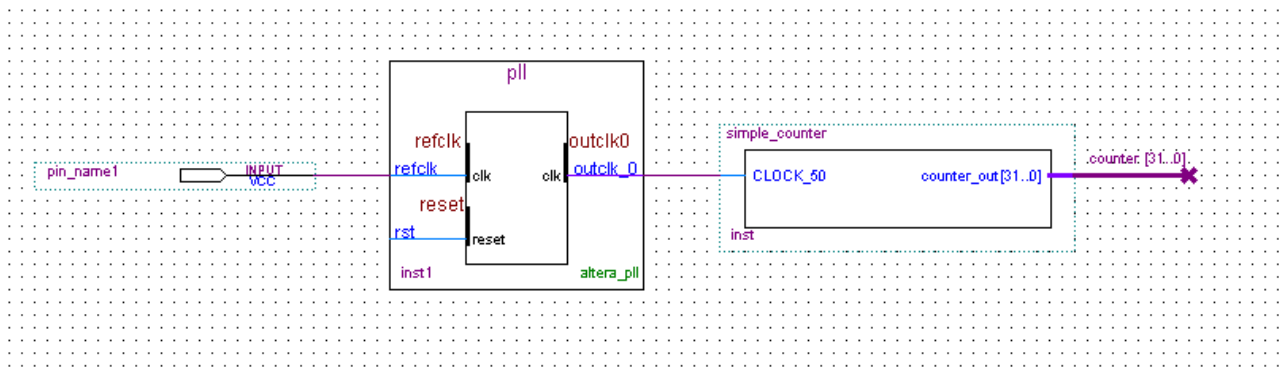

Figure 3-18 Connecting the PLL symbol and Input port

- f. Change the pin name by double-clicking pin_name and typing CLOCK_50 (see **Figure 3-19**). This name correlates to the oscillator clock that is connected to the FPGA.
- g. Using the Orthogonal Bus tool, draw a bus line connected on one side to the simple_counter output port, and leave the other end unconnected at about 4 to 8 grid spaces to the right of the simple_counter.

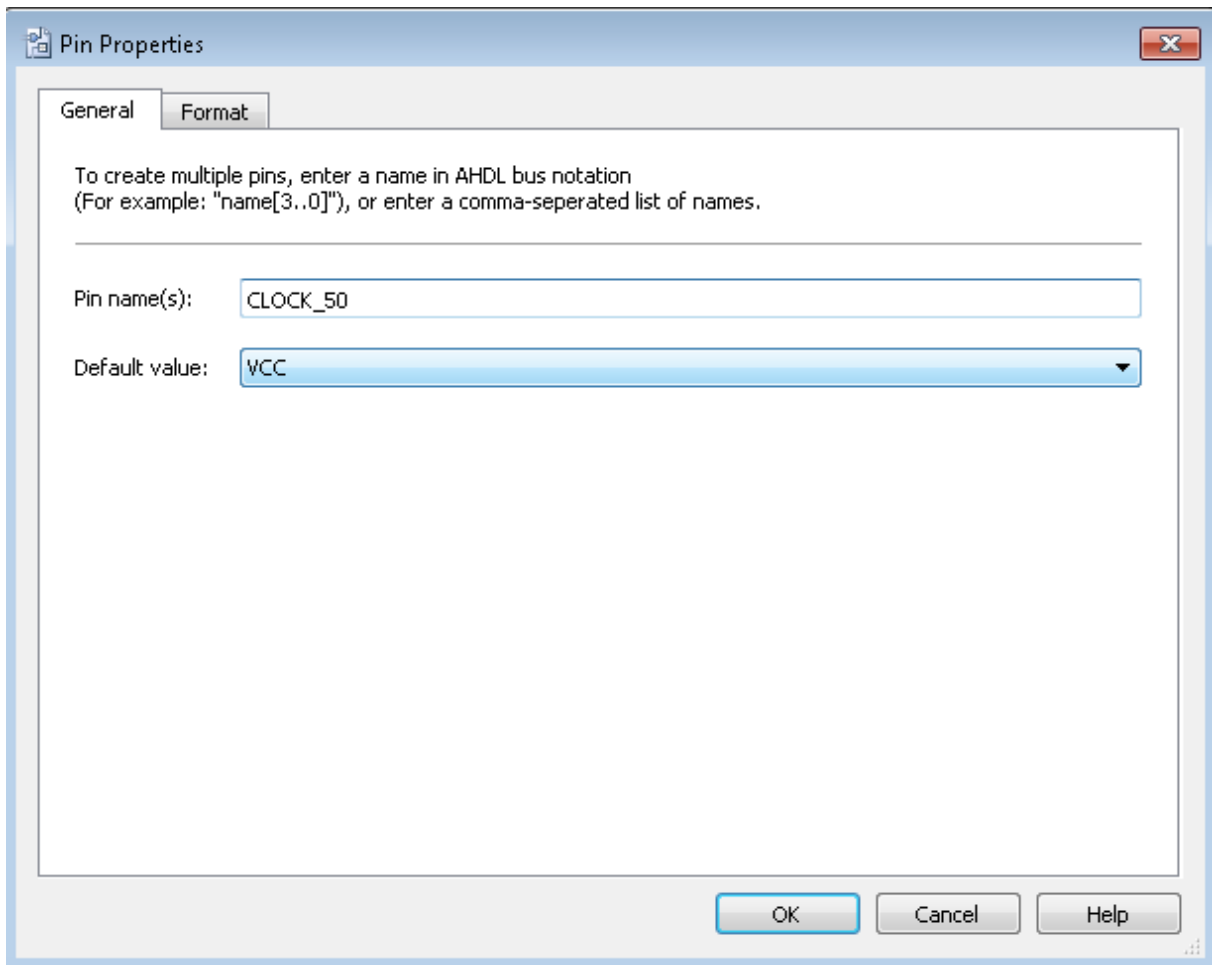

Figure 3-19 Change the input port name

- h. Right-click the new output bus line and choose Properties.
- i. Using the Orthogonal Bus tool, draw a bus line connected on one side to the simple_counter output port, and leave the other end unconnected at about 6 to 8 grid spaces to the right of the simple_counter.
- j. Type counter [31..0] as the bus name (see **Figure 3-20**). The notation [X..Y] is the Quartus II method for specifying the bus width in BDF schematics, where X is the most significant bit (MSB) and Y is the least significant bit (LSB).
- k. Click OK. **Figure 3-21** shows the BDF.

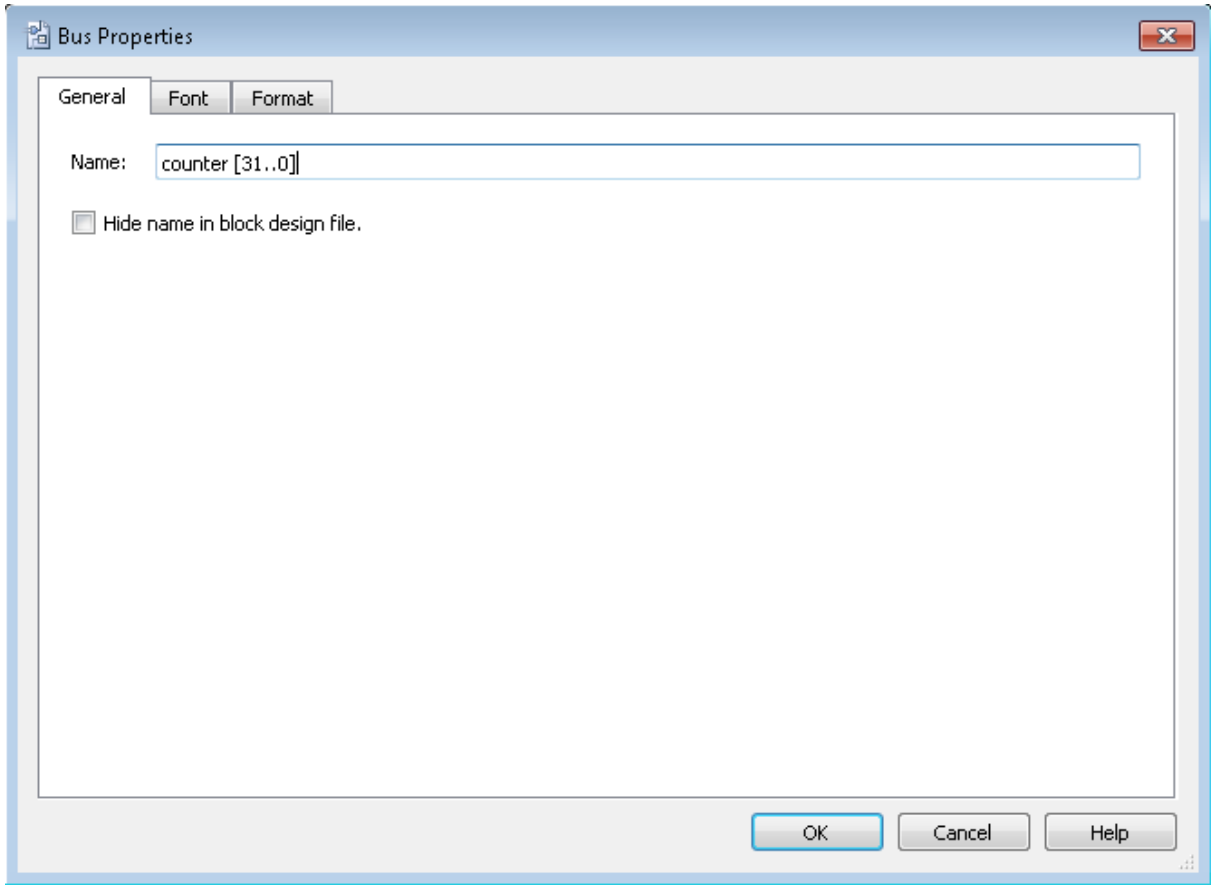

Figure 3-20 Change the output BUS name

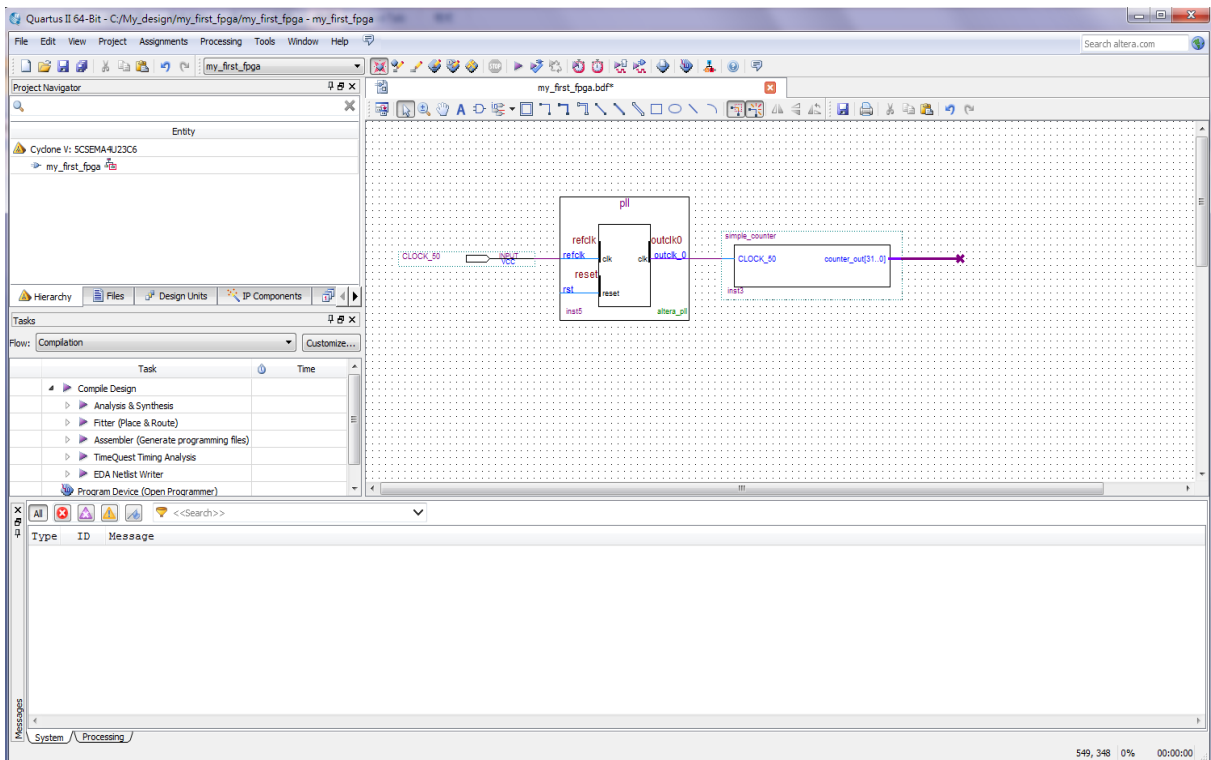

Figure 3-21 BDF

3.2 Add a Multiplexer

This design uses a multiplexer to route the simple_counter output to the LED pins on the DE0-Nano-SoC development board. You will use the MegaWizard Plug-In Manager to add the multiplexer, lpm_mux. The design multiplexes two variations of the counter bus to four LEDs on the DE0-Nano-SoC development board.

1. Choose Edit > Insert Symbol.
2. Click Megawizard Plug-in Manager.
3. Click Next.
4. Choose Installed Plug-Ins > Gates > LPM_MUX.
5. Choose the device family that corresponds to the device on the development board you are using, choose Verilog HDL as the output file type, and name the output file counter_bus_mux.v (see [Figure 3-22](#)).
6. Click OK.

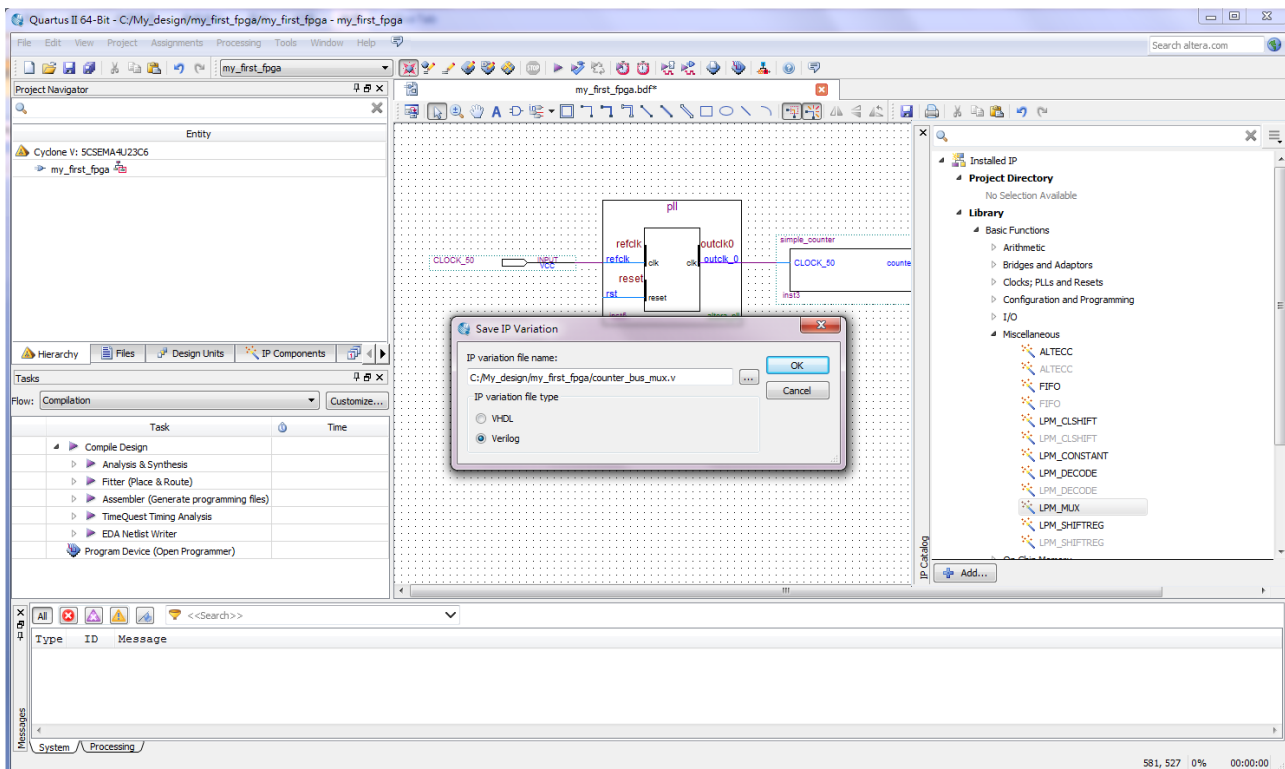

Figure 3-22 Selecting lpm_mux

7. Under How many 'data' inputs do you want? Select 2 inputs (default).

8. Under how wide should the 'data' input and 'result' output be? Select 4 (see **Figure 3-23**).

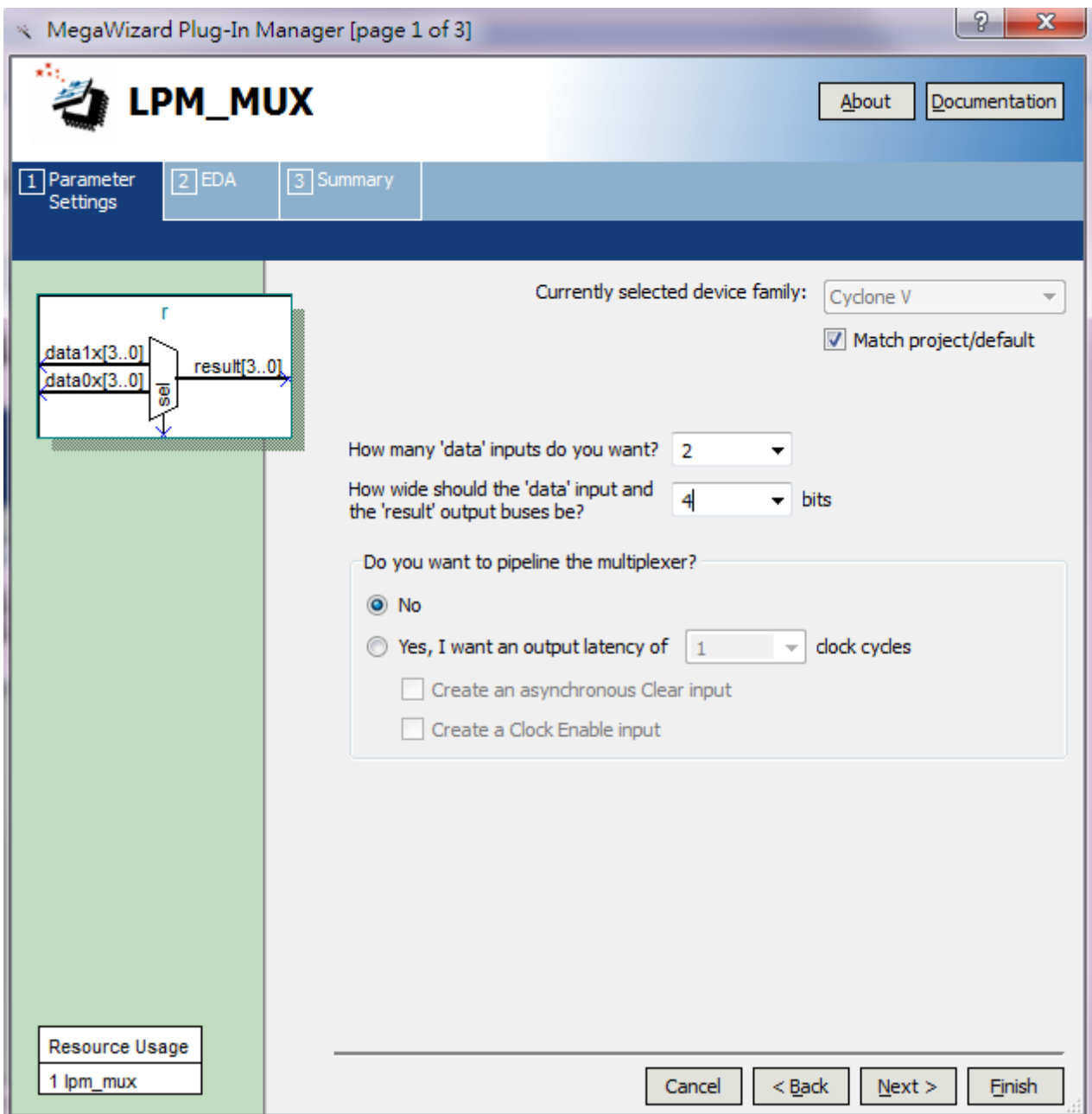

Figure 3-23 lpm_mux settings

9. Click Next.

10. Click Finish twice. The Symbol window appears (see **Figure 3-24** for an example).

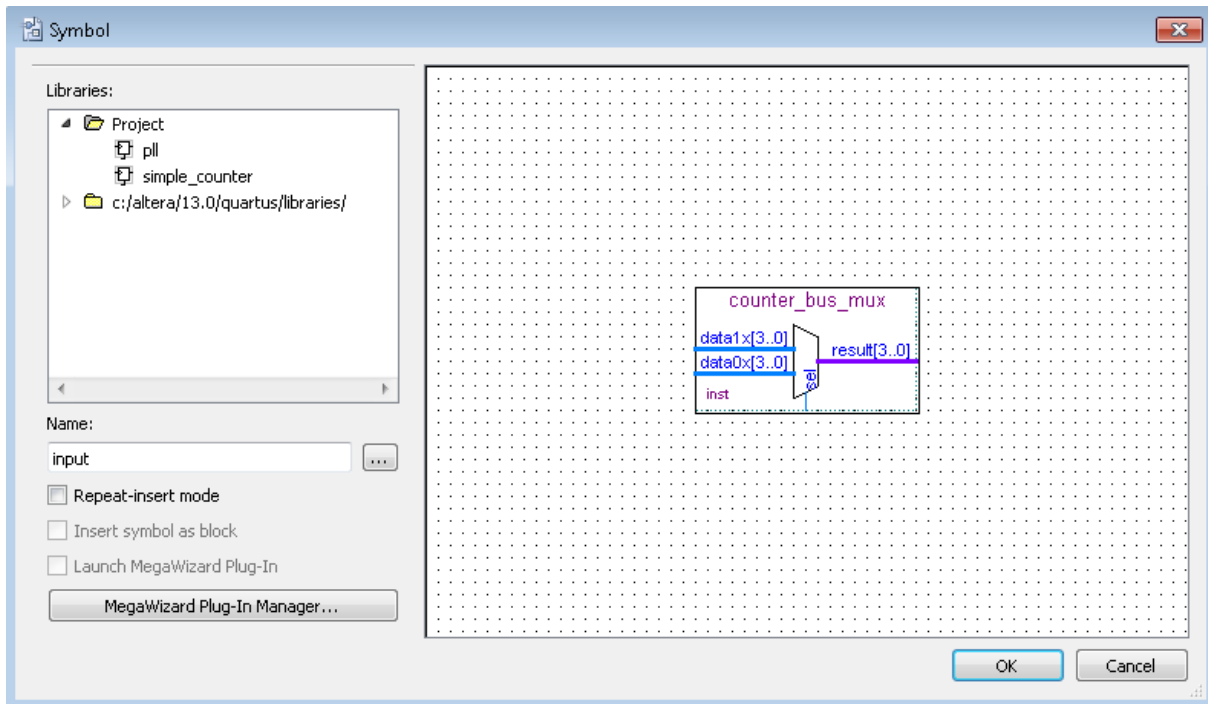

Figure 3-24 lpm_mux Symbol

11. Click OK
12. Place the counter_bus_mux symbol below the existing symbols on the BDF. See [Figure 3-25](#)

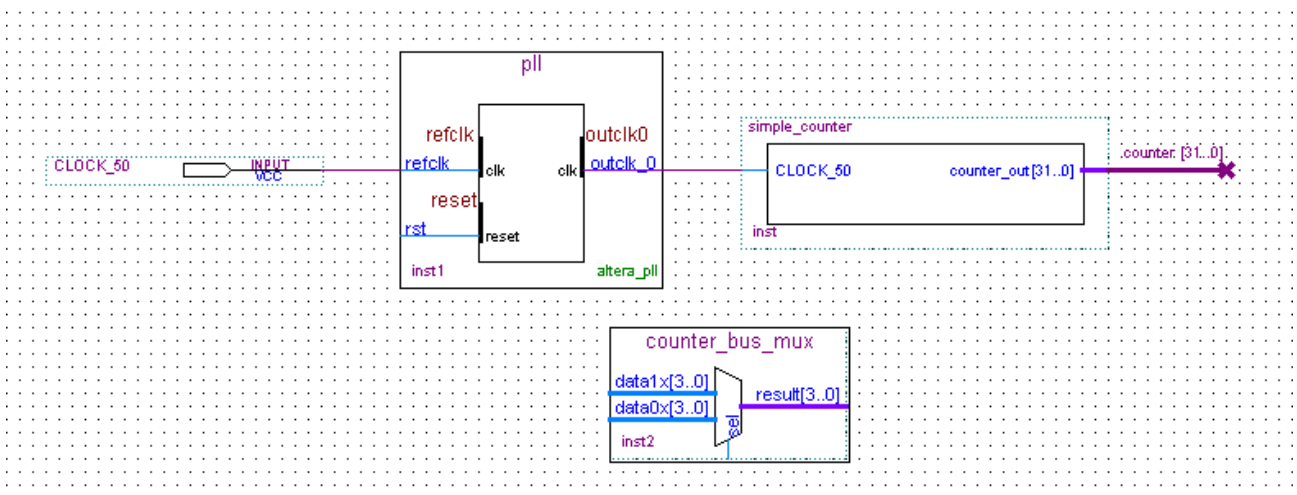

Figure 3-25 Place the lpm_mux symbol

13. Add input buses and output pins to the counter_bus_mux symbol as follows:
 - a. Using the Orthogonal Bus tool, draw bus lines from the data1x[3..0] and data0x[3..0].

Input ports to about 8 to 12 grid spaces to the left of counter_bus_mux.

- b. Draw a bus line from the result [3..0] output port to about 4 to 8 grid spaces to the right of counter_bus_mux.
- c. Right-click the bus line connected to data1x[3..0] and choose Properties.
- d. Name the bus counter[26..23], which selects only those counter output bits to connect to the four bits of the data1x input.

Because the input busses to counter_bus_mux have the same names as the output bus from simple_counter, (counter[x .. y]) the Quartus II software knows to connect these busses.

- e. Click OK.
- f. Right-click the bus line connected to data0x[3..0] and choose Properties.
- g. Name the bus counter [24..21], which selects only those counter output bits to connect to the four bits of the data1x input.
- h. Click OK. **Figure 3-26** shows the renamed buses.

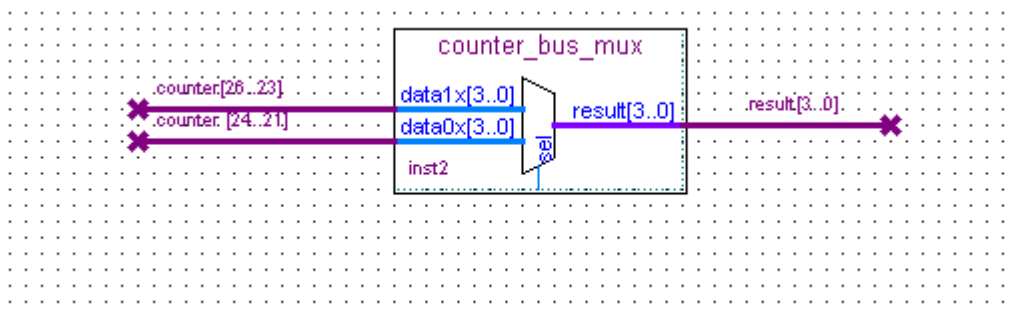

Figure 3-26 Renamed counter_bus_mux Bus Lines

If you have not done so yet, have your project file before continuing.

- 14. Choose Edit > Insert Symbol.
- 15. Under Libraries, double-click quartus/libraries/ > primitives > pin > output (see **Figure 3-27**).

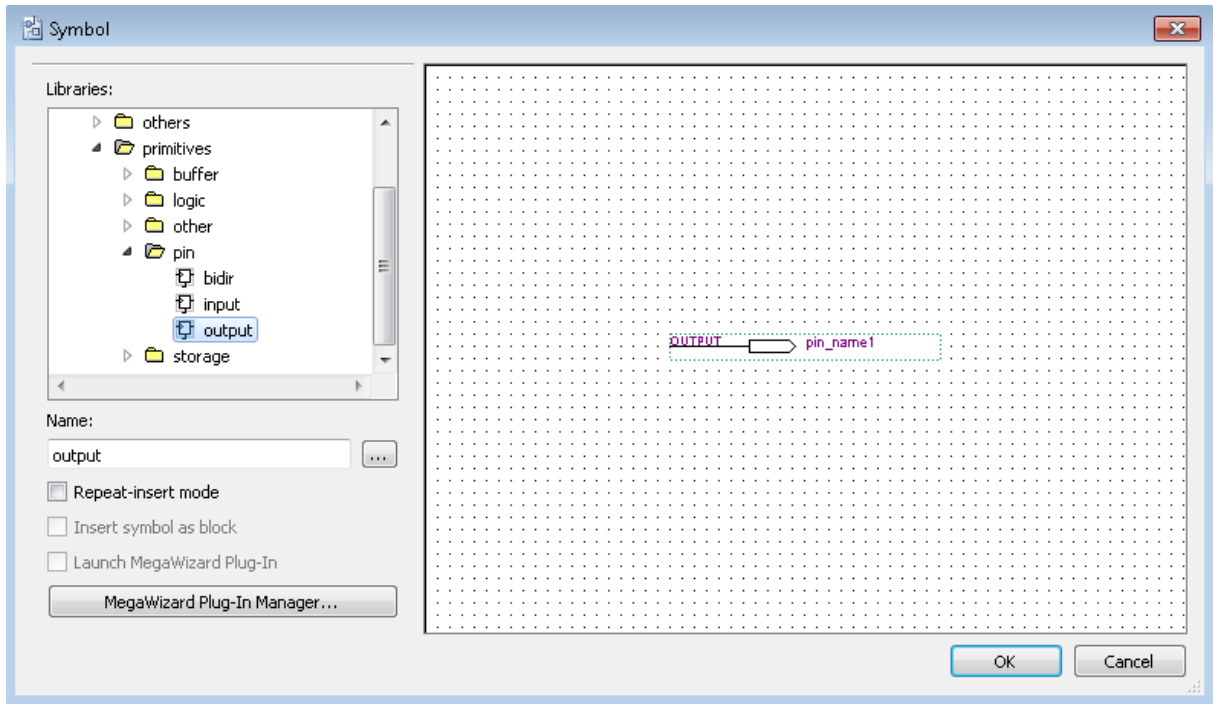

Figure 3-27 choose an output pin

16. Click OK.
17. Place this output pin so that it connects to the counter_bus_mux result [3..0] bus output line.
18. Rename the output pin as LED [3..0] as described in steps 13 c and d. (see **Figure 3-28**).

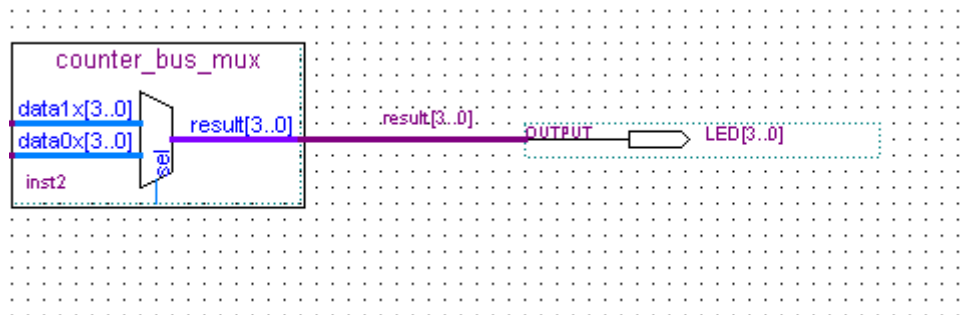

Figure 3-28 Rename the output pin

19. Attach an input pin to the multiplexer select line using an input pin:
 - a. Choose Edit > Insert Symbol.
 - b. Under Libraries, double-click quartus/libraries/ > primitives > pin > input.
 - c. Click OK.
20. Place this input pin below counter_bus_mux.

21. Connect the input pin to the counter_bus_mux sel pin.
22. Rename the input pin as KEY [0].
23. Place another input pin at the left of the pll and rename it as KEY[1] (see **Figure 3-29**).
24. Choose Edit > Insert Symbol.
25. Under Libraries, double-click quartus/libraries/ > primitives > logic > not (see **Figure 3-30**).
26. Click OK.
27. Place this not pin so that it connects to KEY[1] and the pll rst (see **Figure 3-31**).

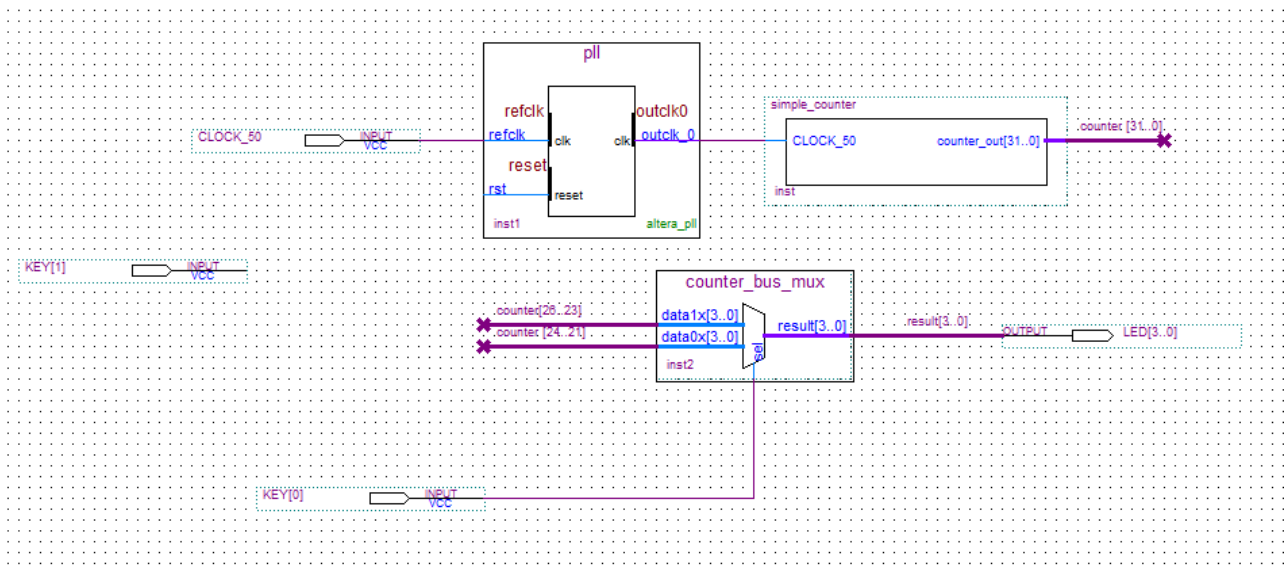

Figure 3-29 Adding the KEY [1:0] Input Pin

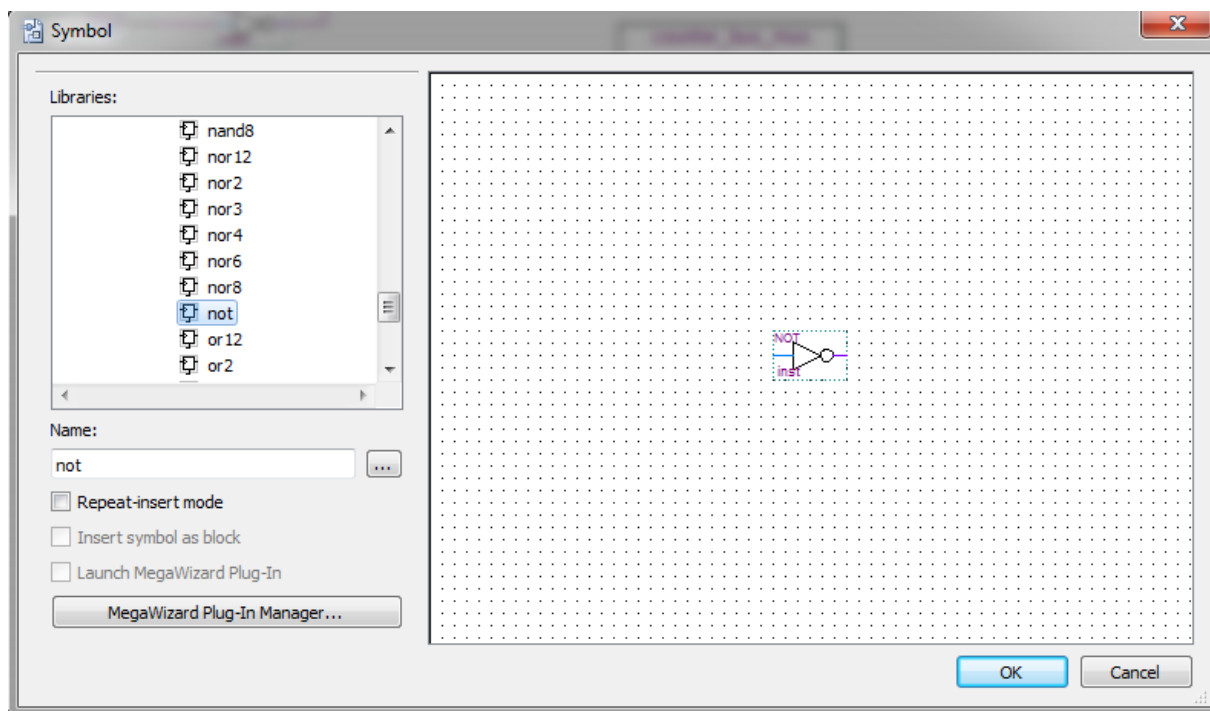

Figure 3-30 choose an not pin

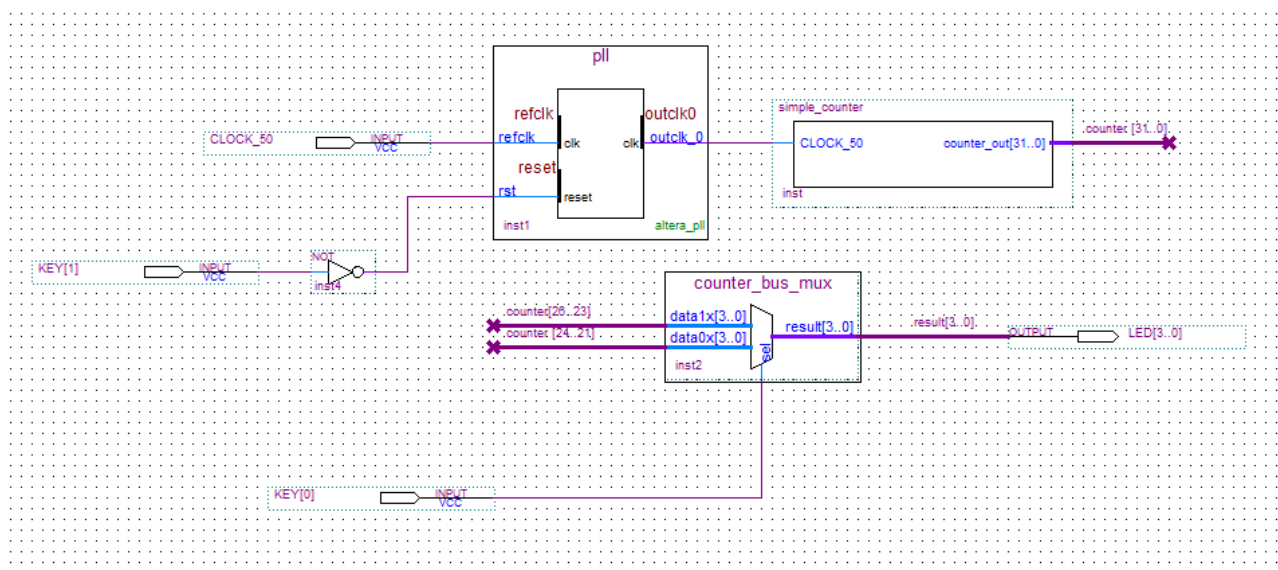

Figure 3-31 Place the not pin

You have finished adding symbols to your design. You can add notes or information to the project as text using the Text tool on the toolbar (indicated with the A symbol). For example, you can add the label “OFF = SLOW, ON = FAST” to the KEY [0] input pin and add a project description, such as “My First FPGA Project.”

3.3 Assign the Pins

In this section, you will make pin assignments. Before making pin assignments, perform the following steps:

1. Choose Processing > Start > Start Analysis & Elaboration in preparation for assigning pin locations.
2. Click OK in the message window that appears after analysis and elaboration completes.

To make pin assignments that correlate to the KEY[1:0] and CLOCK_50 input pins and LED[3..0] output pin, perform the following steps:

1. Choose Assignments > Pin Planner, which opens the Pin Planner, a spreadsheet-like table of specific pin assignments. The Pin Planner shows the design's six pins. See [Figure 3-32](#).

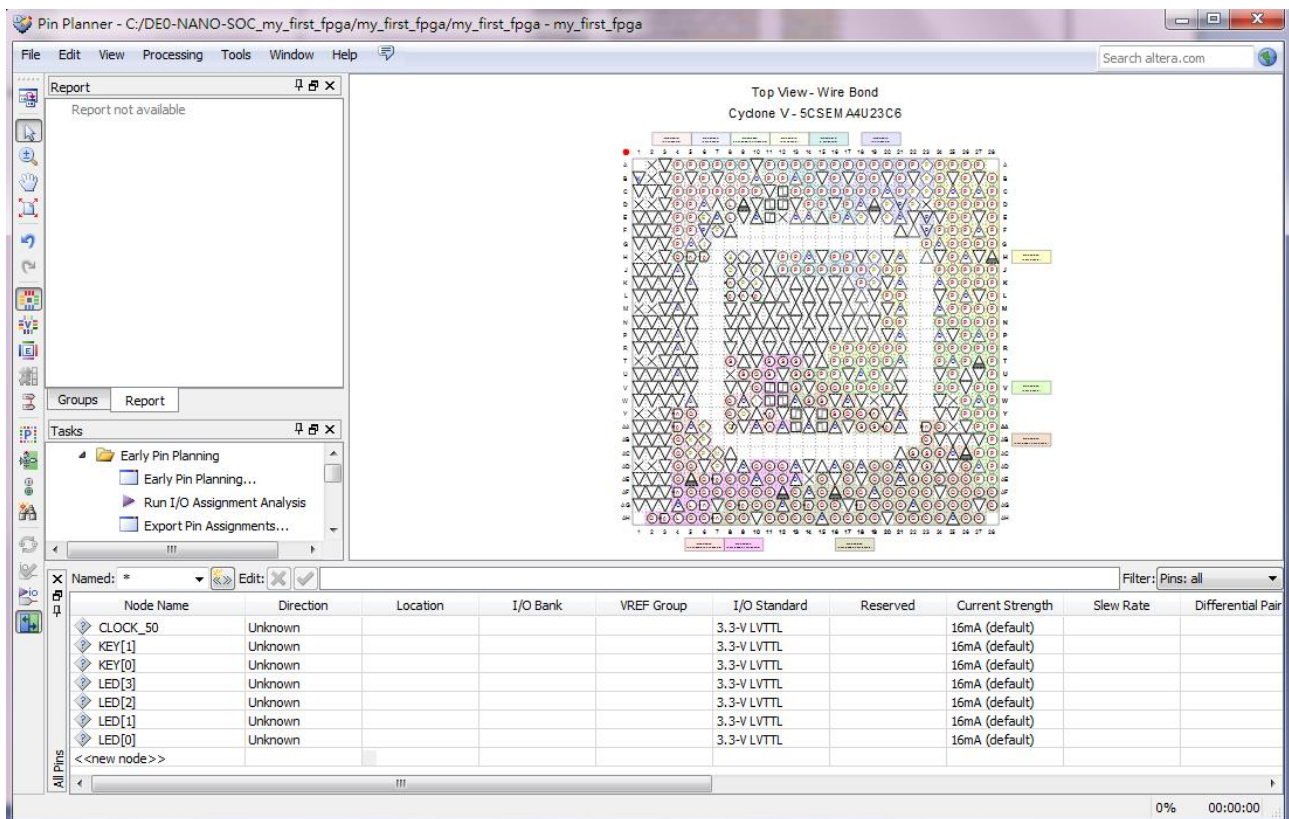

Figure 3-32 Pin Planner Example

2. In the Location column next to each of the seven node names, add the coordinates (pin numbers) as shown in [Table 3-1](#) for the actual values to use with your DE0-Nano-SoC board.

Table 3-1 Pin Information Setting

<i>Pin Name</i>	<i>FPGA Pin Location</i>
CLOCK_50	V11
KEY[1]	AH16
KEY[0]	AH17
LED[3]	V15
LED[2]	V16
LED[1]	AA24
LED[0]	W15

Double-click in the Location column for any of the seven pins to open a drop-down list and type the location shown in the table alternatively, you can select the pin from a drop-down list. For example, if you type F1 and press the Enter key, the Quartus II software fills in the full PIN_F1 location name for you. The software also keeps track of corresponding FPGA data such as the I/O bank and VREF Group. Each bank has a distinct color, which corresponds to the top-view wire bond drawing in the upper right window. See **Figure 3-33**.

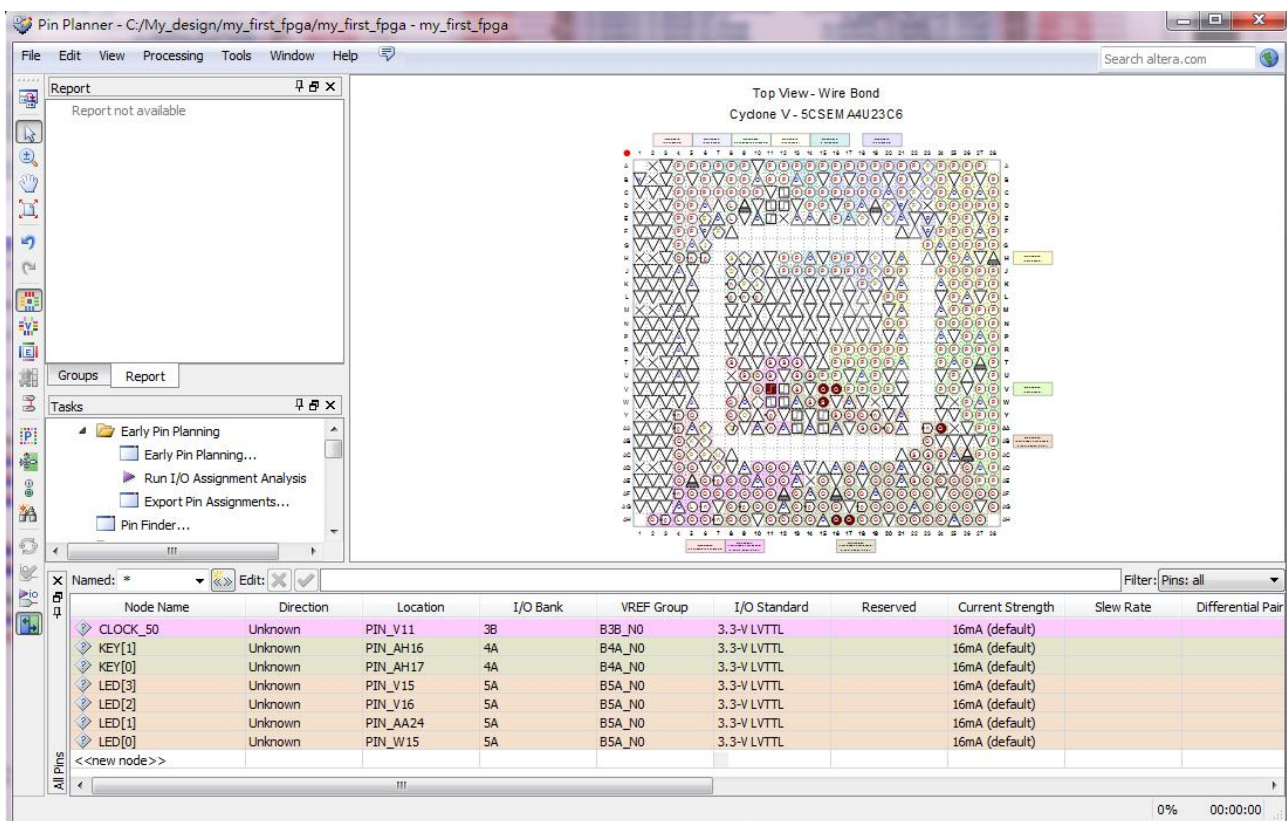

Figure 3-33 Completed Pin Planning Example

Now, you are finished creating your Quartus II design!

3.4 Create a Default TimeQuest SDC File

Timing settings are critically important for a successful design. For this tutorial you will create a basic Synopsys Design Constraints File (.sdc) that the Quartus II TimeQuest Timing Analyzer uses during design compilation. For more complex designs, you will need to consider the timing requirements more carefully.

To create an SDC, perform the following steps:

1. Open the TimeQuest Timing Analyzer by choosing Tools > TimeQuest Timing Analyzer.
2. Choose File > New SDC file. The SDC editor opens.
3. Type the following code into the editor:

```
create_clock -name "CLOCK_50" -period 20.000ns [get_ports {CLOCK_50}]
```

```
derive_pll_clocks
```

```
derive_clock_uncertainty
```

4. Save this file as my_first_fpga.sdc (see [Figure 3-34](#)).

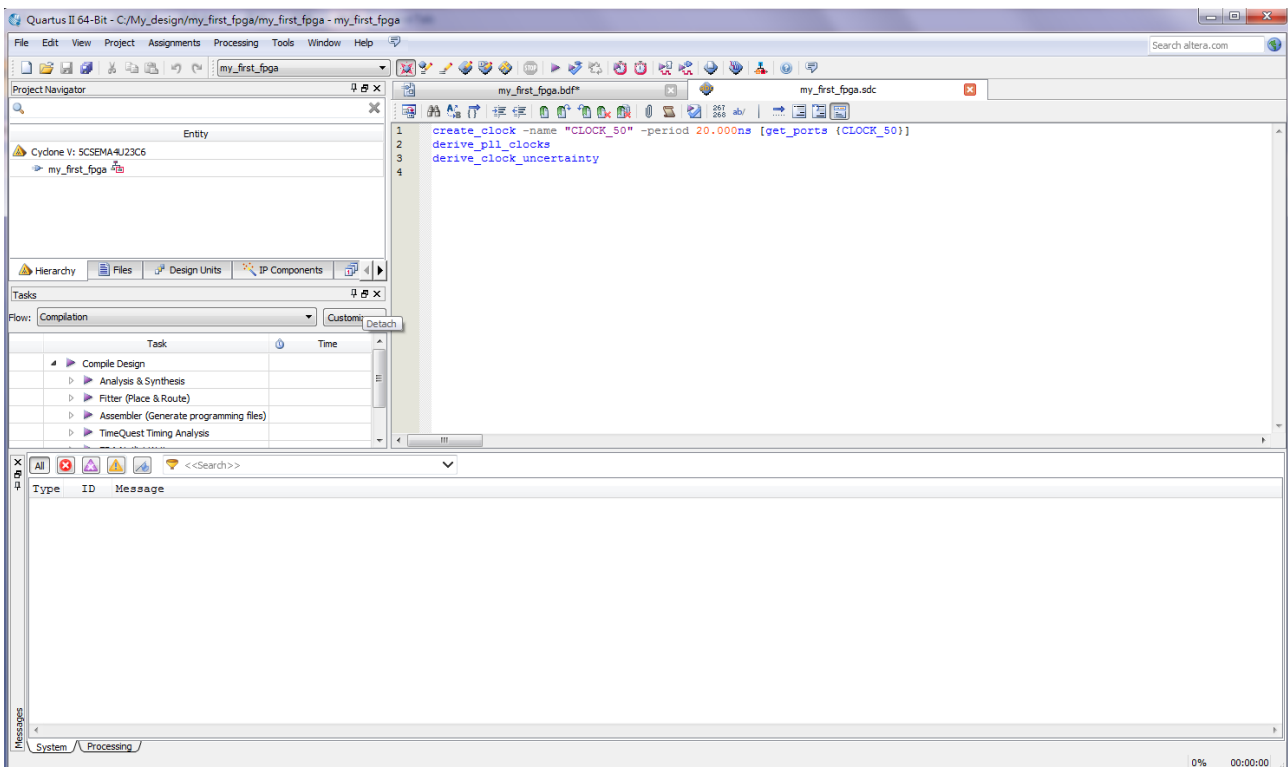

Figure 3-34 Default SDC

Naming the SDC with the same name as the top-level file except for the .sdc extension causes the Quartus II software to use this timing analysis file automatically by default. If you used another name, you would need to add the SDC to the assignments file list.

Compile and Verify Your Design

After creating your design you must compile it. Compilation converts the design into a bitstream that can be downloaded into the FPGA. The most important output of compilation is an SRAM Object File (.sof), which you use to program the device. The software also generates other report files that provide information about your code as it compiles.

4.1 Compile Your Design

If you want to store .SOF in memory device (such as flash or EEPROMs), you must first convert the SOF to a file type specifically for the targeted memory device.

Now that you have created a complete Quartus II project and entered all assignments, you can compile the design.

In the Processing menu, choose Start Compilation or click the Play button on the toolbar.

If you are asked to save changes to your BDF, click Yes.

While compiling your design, the Quartus II software provides useful information about the compilation (see **Figure 4-1**).

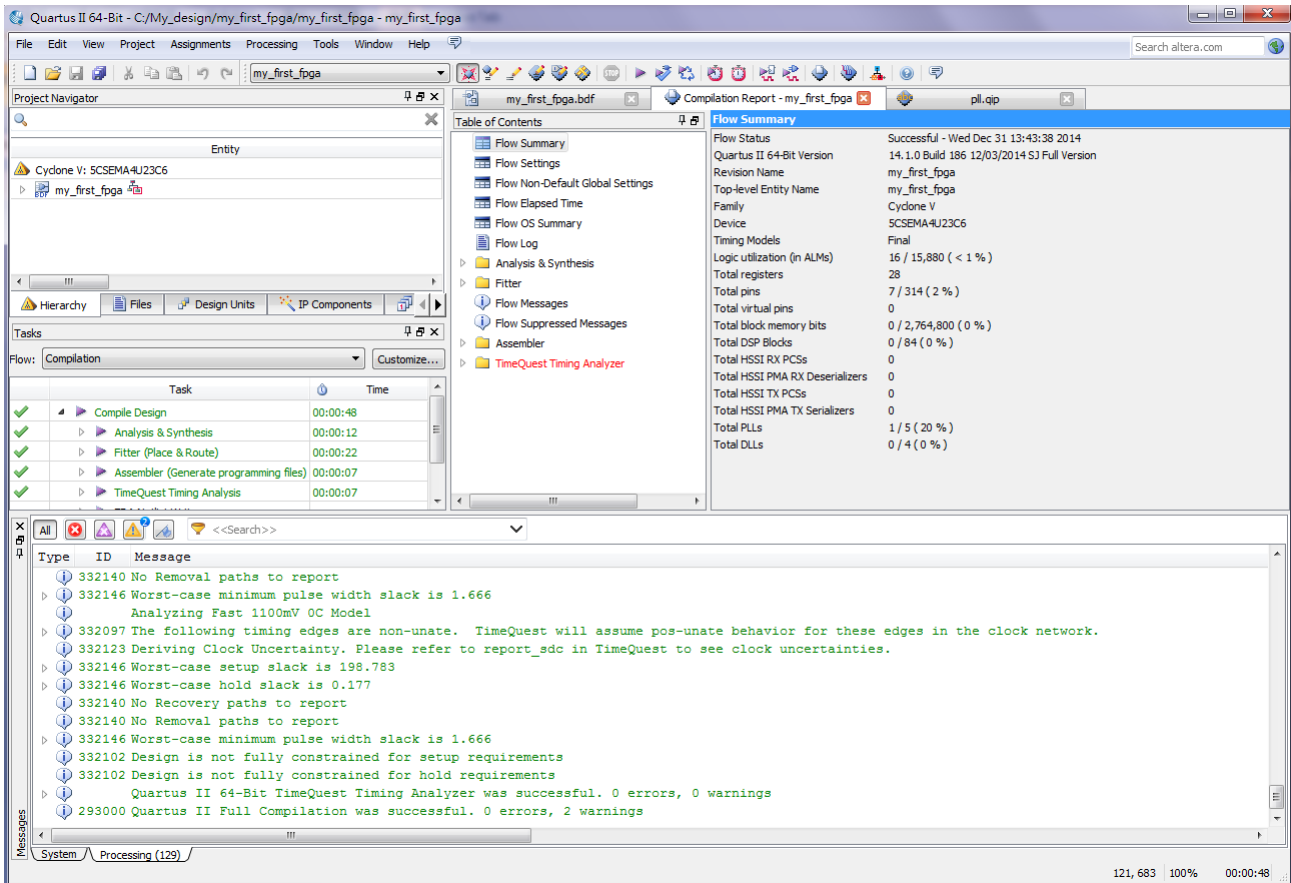

Figure 4-1 Compilation Message for project

When compilation is complete, the Quartus II software displays a message. Click OK to close the message box.

The Quartus II Messages window displays many messages during compilation. It should not display any critical warnings; it may display a few warnings that indicate that the device timing information is preliminary or that some parameters on the I/O pins used for the LEDs were not set. The software provides the compilation results in the Compilation Report tab as shown in **Figure 4-2**.

Flow Summary	
Flow Status	Successful - Wed Dec 31 13:43:38 2014
Quartus II 64-Bit Version	14.1.0 Build 186 12/03/2014 SJ Full Version
Revision Name	my_first_fpga
Top-level Entity Name	my_first_fpga
Family	Cyclone V
Device	5CSEMA4U23C6
Timing Models	Final
Logic utilization (in ALMs)	16 / 15,880 (< 1 %)
Total registers	28
Total pins	7 / 314 (2 %)
Total virtual pins	0
Total block memory bits	0 / 2,764,800 (0 %)
Total DSP Blocks	0 / 84 (0 %)
Total HSSI RX PCSs	0
Total HSSI PMA RX Deserializers	0
Total HSSI TX PCSs	0
Total HSSI PMA TX Serializers	0
Total PLLs	1 / 5 (20 %)
Total DLLs	0 / 4 (0 %)

Figure 4-2 Compilation Report Example

4.2 Program the FPGA Device

After compiling and verifying your design you are ready to program the FPGA on the development board. You download the SOF you just created into the FPGA using the USB-BlasterII circuitry on the board. Set up your hardware for programming using the following steps:

- a) Connect the power supply cable to your board and to a power outlet.
- b) For the DE0-Nano-SoC board, connect the USB-BlasterII (included in your development kit) to J13 and the USB cable to the USB-BlasterII. Connect the other end of the USB cable to the host computer.

Refer to the getting started user guide for detailed instructions on how to connect the cables.

- c) Turn the DE0-Nano-SoC board on using the on/off switch.

Program the FPGA using the following steps.

1. Choose Tools > Programmer. The Programmer window opens. See **Figure 4-3**.

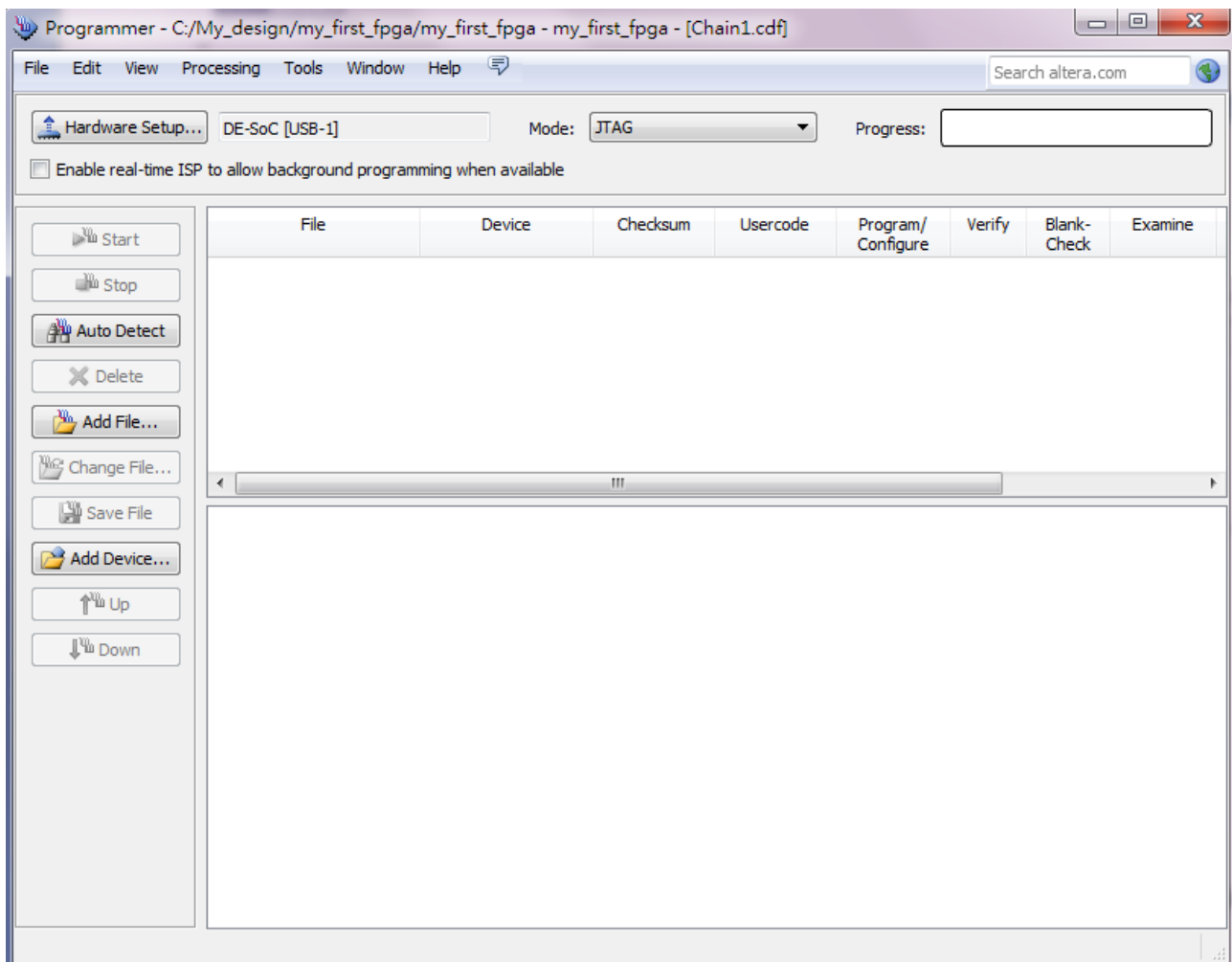

Figure 4-3 Programmer Window

2. Click Hardware Setup.
3. If it is not already turned on, turn on the DE0-Nano-SoC [USB-1] option under currently selected hardware. See **Figure 4-4**.

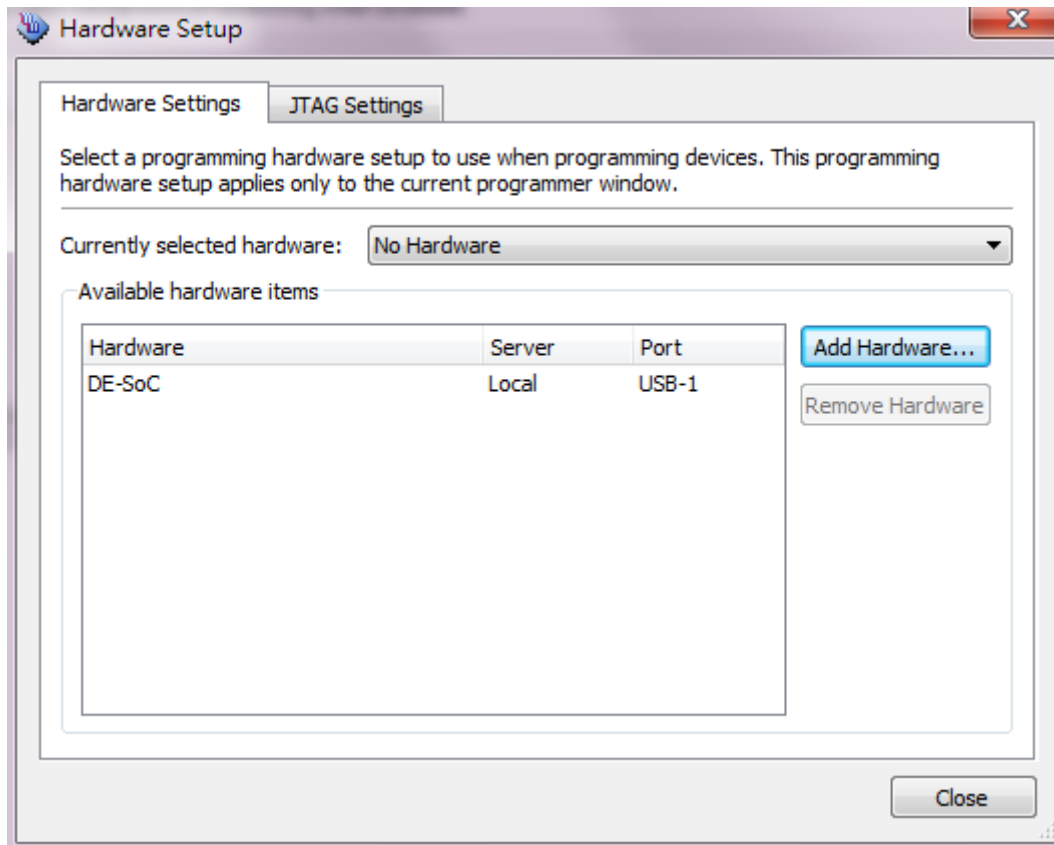

Figure 4-4 Hardware Setting

4. Click Close.
5. Click Auto Detect to detect all the devices on the JTAG chain.
6. Select 5CSEMA4 and click OK.

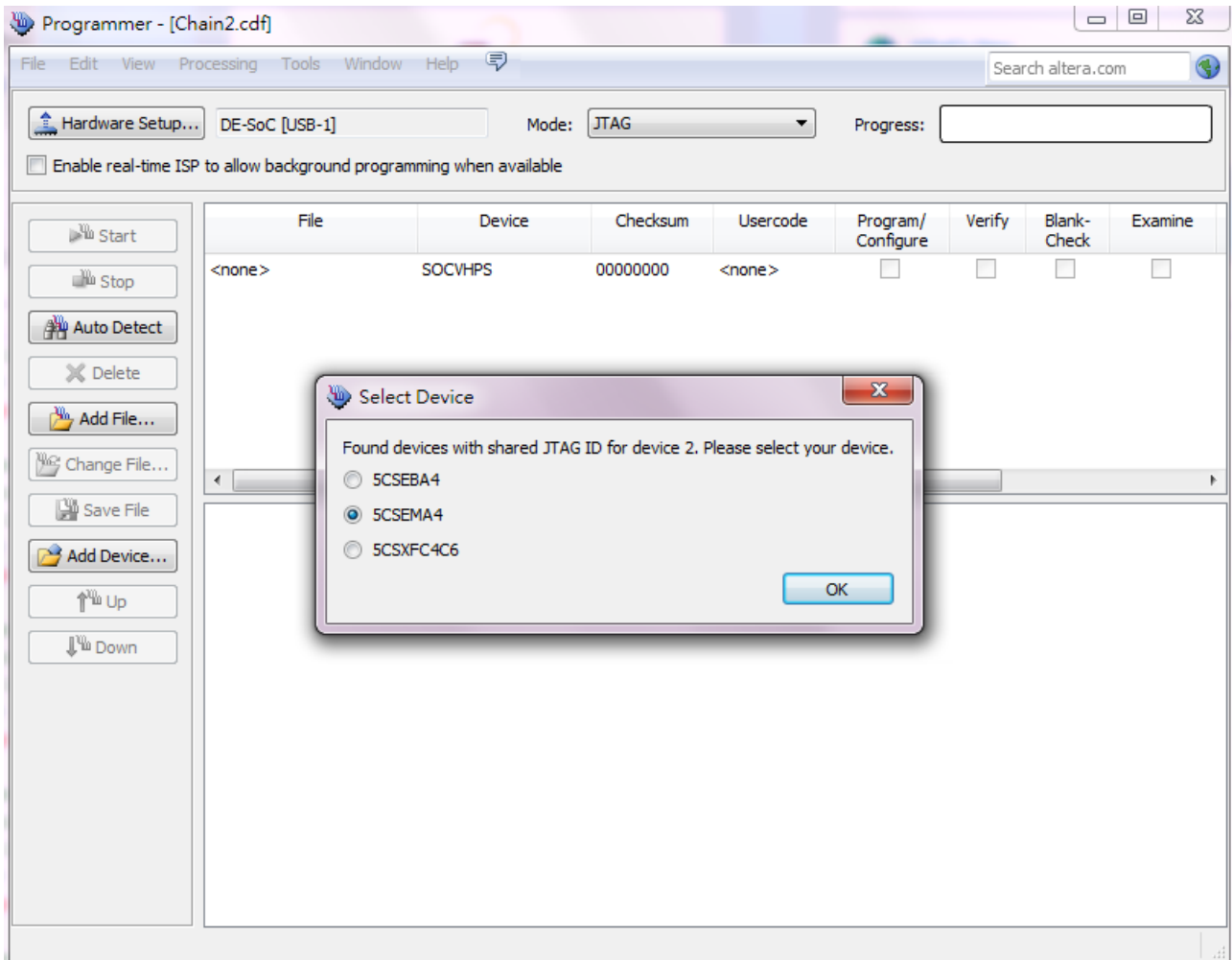

Figure 4-5 Select FPGA Device

7. Click Yes to match device list.

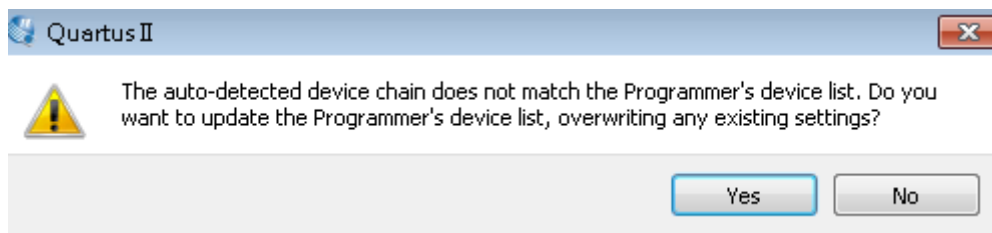

Figure 4-6 Warning for device list not match

8. Both HPS and FPGA will be list on the programmer. Select FPGA device and click Change File a .sof file.

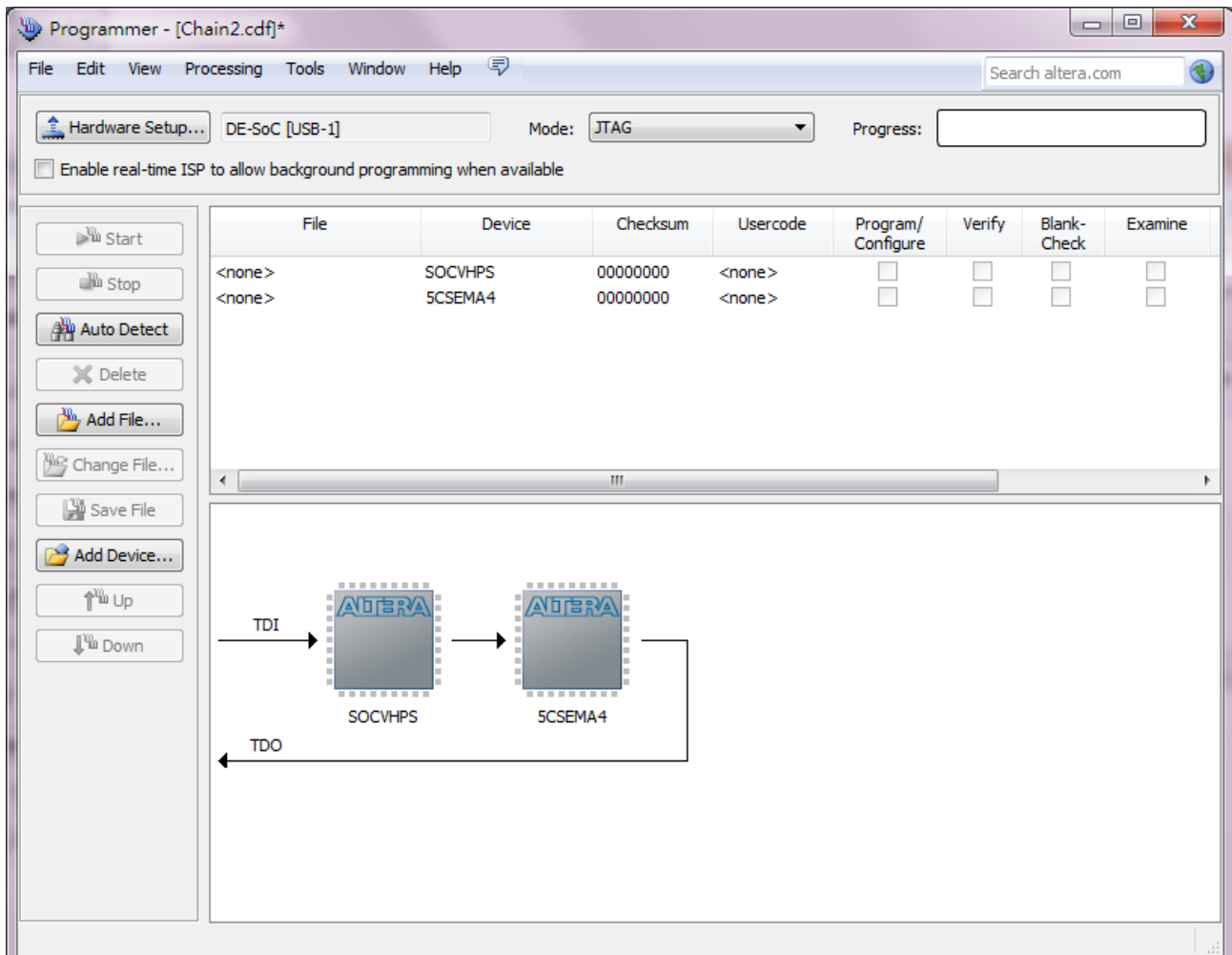

Figure 4-7 Programmer window

9. Selecting the my_first_fpga.sof file from the project directory (see [Figure 4-8](#)), select to Program/Configure and click Start to program .sof file into FPGA.

[Figure 4-8](#)),

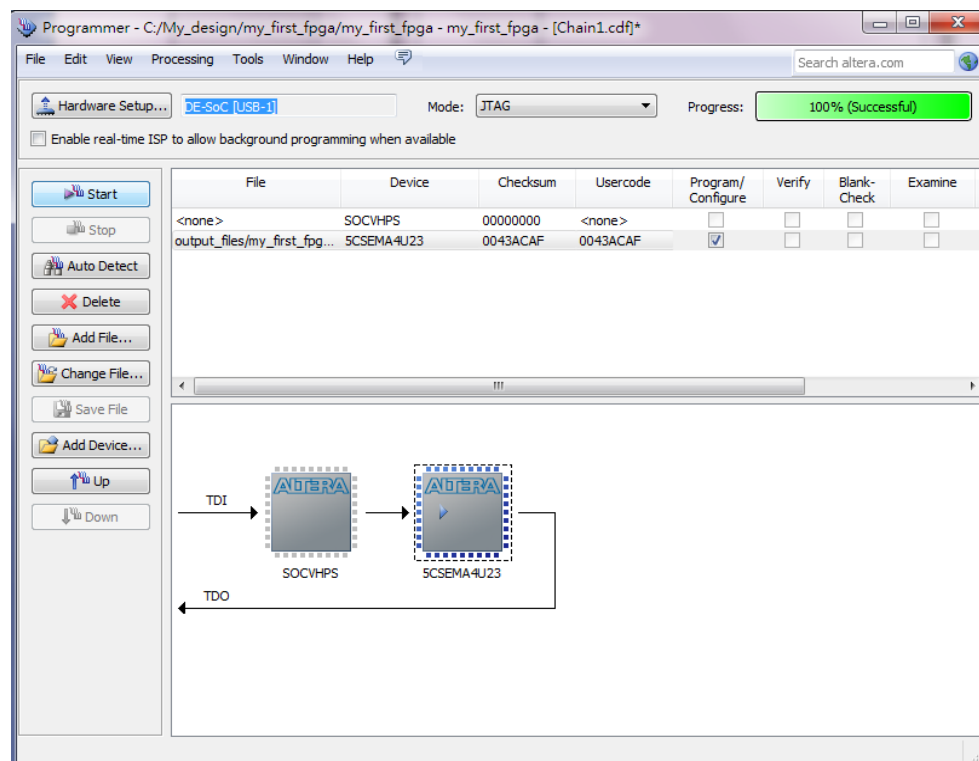
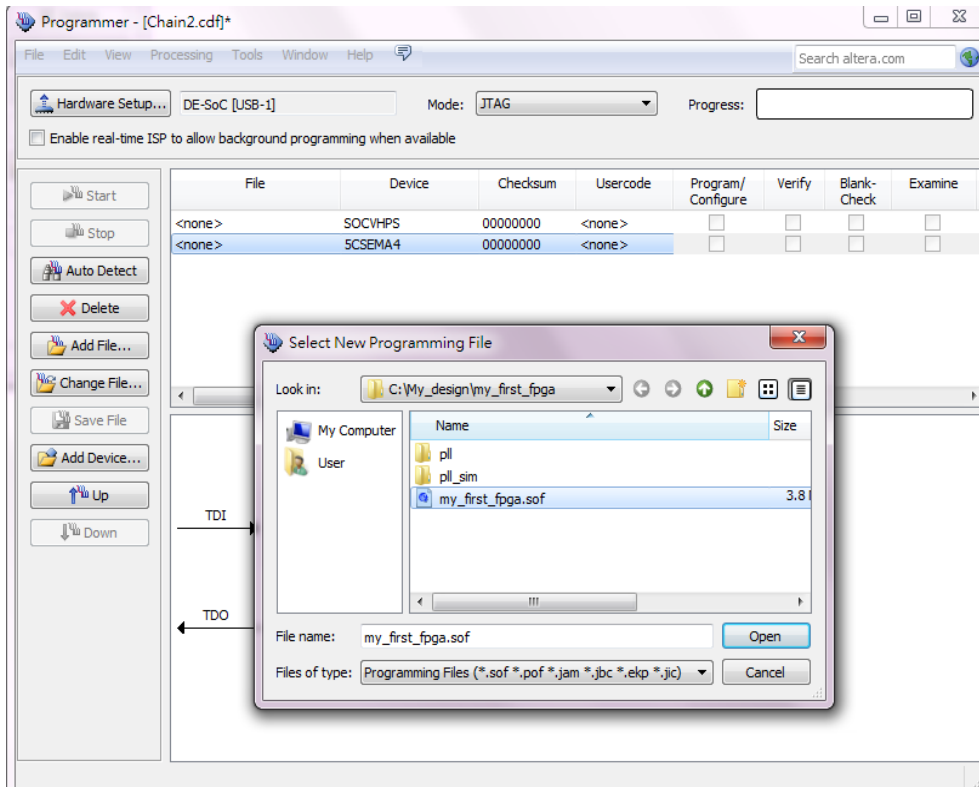

Figure 4-8 Downloading Complete

Congratulations, you have created, compiled, and programmed your first FPGA design! The compiled SRAM Object File (.sof) is loaded onto the FPGA on the development board and the design should be running.

4.3 Verify The Hardware

When you verify the design in hardware, you observe the runtime behavior of the FPGA hardware design and ensure that it is functioning appropriately.

Verify the design by performing the following steps:

1. Observe that the four development board LEDs appear to be advancing slowly in a binary count pattern, which is driven by the `simple_counter` bits [26..23].

The LEDs are active high, therefore, when counting begins all LEDs are turned off (the 0000 state).

2. Press and hold `KEY [0]` on the development board and observe that the LEDs advance more quickly. Pressing this `KEY` causes the design to multiplex using the faster advancing part of the counter (bits [24..21]).

3. If other LEDs emit faintness light, Choose `Assignments > Device`. Click `Device` and `Pin Options`. See [Figure 4-8](#).

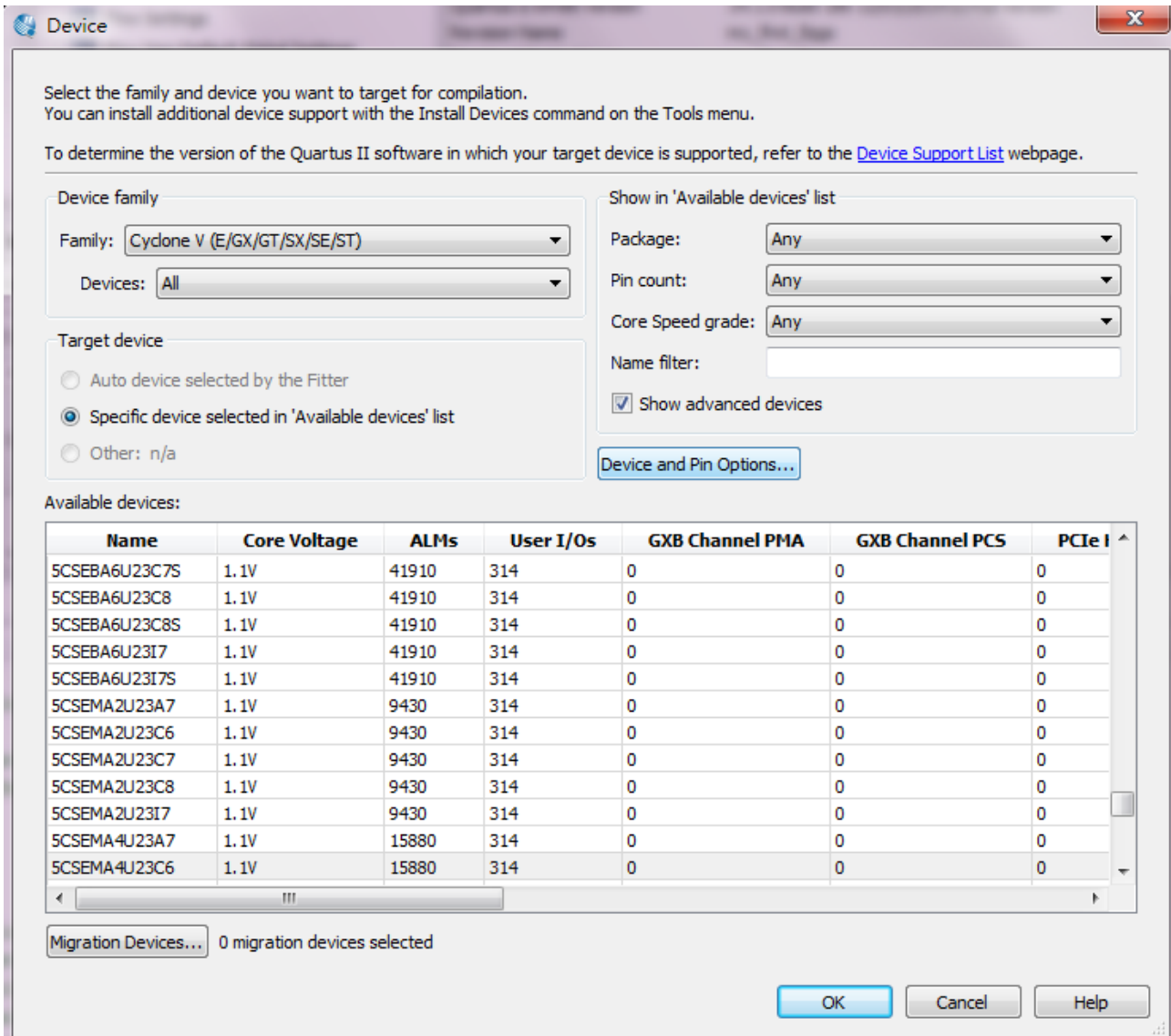

Figure 4-8 Device and Options

Choose Unused Pins. Reserve all unused pins: Choose the As input tri-stated option. See **Figure 4-9**.

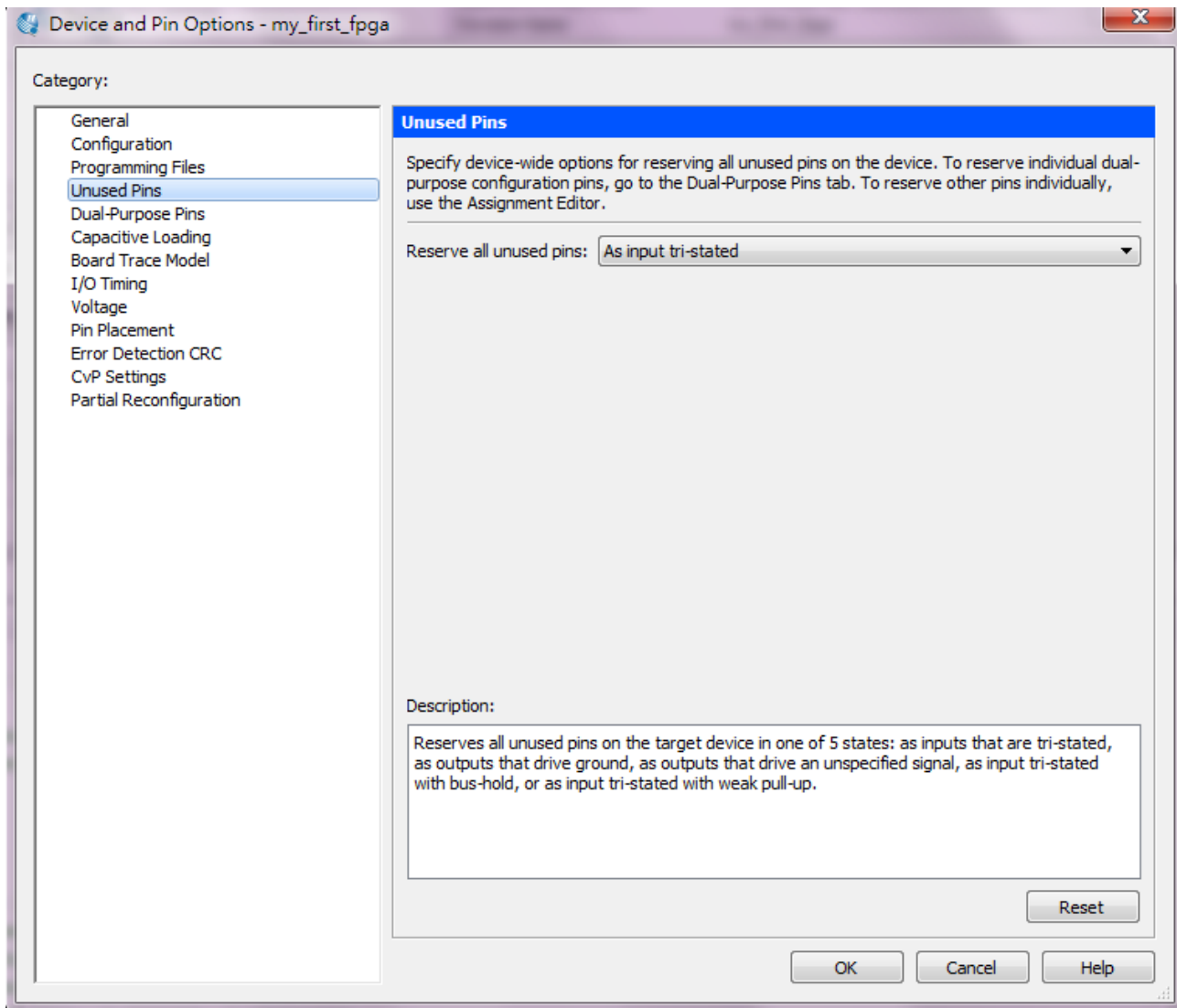

Figure 4-9 Setting unused pins

Click twice OK.

4. In the Processing menu, choose Start Compilation. After the compile, Choose Tools > Programmer. Select the my_first_fpga.sof file from the project directory. Click Start. At this time you could find the other LEDs are unlighted.

5.1 Headquarter & Branches

- Tel : +886-3-575-0880
- Fax : +886-3-572-6690
- Add : 9F, No.176, Sec.2, Gongdao 5th Rd, East Dist, Hsinchu City, Taiwan 300-70
- Email : sales@terasic.com / support@terasic.com