

# 7 Series FPGAs Packaging and Pinout

## *Product Specification*

UG475 (v1.10) November 15, 2013



## NOTICE OF DISCLAIMER

The information disclosed to you hereunder (the “Materials”) is provided solely for the selection and use of Xilinx products. To the maximum extent permitted by applicable law: (1) Materials are made available “AS IS” and with all faults, Xilinx hereby DISCLAIMS ALL WARRANTIES AND CONDITIONS, EXPRESS, IMPLIED, OR STATUTORY, INCLUDING BUT NOT LIMITED TO WARRANTIES OF MERCHANTABILITY, NON-INFRINGEMENT, OR FITNESS FOR ANY PARTICULAR PURPOSE; and (2) Xilinx shall not be liable (whether in contract or tort, including negligence, or under any other theory of liability) for any loss or damage of any kind or nature related to, arising under, or in connection with, the Materials (including your use of the Materials), including for any direct, indirect, special, incidental, or consequential loss or damage (including loss of data, profits, goodwill, or any type of loss or damage suffered as a result of any action brought by a third party) even if such damage or loss was reasonably foreseeable or Xilinx had been advised of the possibility of the same. Xilinx assumes no obligation to correct any errors contained in the Materials or to notify you of updates to the Materials or to product specifications. You may not reproduce, modify, distribute, or publicly display the Materials without prior written consent. Certain products are subject to the terms and conditions of Xilinx’s limited warranty, please refer to Xilinx’s Terms of Sale which can be viewed at <http://www.xilinx.com/legal.htm#tos>; IP cores may be subject to warranty and support terms contained in a license issued to you by Xilinx. Xilinx products are not designed or intended to be fail-safe or for use in any application requiring fail-safe performance; you assume sole risk and liability for use of Xilinx products in such critical applications, please refer to Xilinx’s Terms of Sale which can be viewed at <http://www.xilinx.com/legal.htm#tos>.

## AUTOMOTIVE APPLICATIONS DISCLAIMER

XILINX PRODUCTS ARE NOT DESIGNED OR INTENDED TO BE FAIL-SAFE, OR FOR USE IN ANY APPLICATION REQUIRING FAIL-SAFE PERFORMANCE, SUCH AS APPLICATIONS RELATED TO: (I) THE DEPLOYMENT OF AIRBAGS, (II) CONTROL OF A VEHICLE, UNLESS THERE IS A FAIL-SAFE OR REDUNDANCY FEATURE (WHICH DOES NOT INCLUDE USE OF SOFTWARE IN THE XILINX DEVICE TO IMPLEMENT THE REDUNDANCY) AND A WARNING SIGNAL UPON FAILURE TO THE OPERATOR, OR (III) USES THAT COULD LEAD TO DEATH OR PERSONAL INJURY. CUSTOMER ASSUMES THE SOLE RISK AND LIABILITY OF ANY USE OF XILINX PRODUCTS IN SUCH APPLICATIONS.

© Copyright 2011–2013 Xilinx, Inc. XILINX, the Xilinx logo, Virtex, Kintex, Artix, Zynq, Spartan, ISE, Vivado, and other designated brands included herein are trademarks of Xilinx in the United States and other countries. All other trademarks are the property of their respective owners.

## Revision History

The following table shows the revision history for this document.

Date	Version	Revision
03/01/2011	1.0	Initial Xilinx release.
04/06/2011	1.1	Removed the SBG324 package from the entire document. Added three Kintex-7 devices: XC7K355T, XC7K420T, and XC7K480T. Updated disclaimer and copyright on <a href="#">page 2</a> . Updated package size of FF1156 in <a href="#">Table 1-1</a> . Updated <a href="#">DXP_0</a> , <a href="#">DXN_0</a> in <a href="#">Table 1-11</a> . The <a href="#">Table 2-2</a> single ASCII device files have been updated for both the <a href="#">XC7K70T</a> and <a href="#">XC7K160T</a> . All ASCII TXT files and the overall ZIP file have been updated on the web. Updated the XC7K70TFBG676 figures: <a href="#">Figure 3-37</a> , <a href="#">Figure 3-38</a> , <a href="#">Figure 3-39</a> , and <a href="#">Figure 3-40</a> . Added information to <a href="#">Chapter 4, Mechanical Drawings</a> , <a href="#">Chapter 5, Thermal Specifications</a> , and <a href="#">Chapter 6, Package Marking</a> .

Date	Version	Revision
06/14/2011	1.2	<p>Added Virtex-7 device information including updating <a href="#">Table 1-1</a>, adding <a href="#">Table 1-3</a>, <a href="#">Table 1-9</a>, <a href="#">Table 2-3</a>, and <a href="#">Table 3-3</a>. In <a href="#">Table 1-11</a>, updated <a href="#">Note 3</a>, the <a href="#">Configuration Pins</a> section, and the <a href="#">Analog to Digital Converter (XADC) Pins</a> section.</p> <p>Updated <a href="#">Figure 3-35</a>, <a href="#">Figure 3-36</a>, <a href="#">Figure 3-39</a>, <a href="#">Figure 3-40</a>, <a href="#">Figure 3-43</a>, <a href="#">Figure 3-44</a>, <a href="#">Figure 3-47</a>, <a href="#">Figure 3-48</a>, <a href="#">Figure 3-51</a>, <a href="#">Figure 3-52</a>, <a href="#">Figure 3-55</a>, and <a href="#">Figure 3-56</a>. Added <a href="#">Figure 3-56</a> through <a href="#">Figure 3-120</a>.</p> <p>Added <a href="#">Figure 4-27</a> the mechanical drawing for the Kintex-7 devices FFG1156 package. Also added some Virtex-7 device mechanical drawings in <a href="#">Figure 4-27</a> through <a href="#">Figure 4-33</a>.</p> <p>Added thermal resistance data to <a href="#">Table 5-1</a>.</p>
10/03/2011	1.3	<p>Added Artix-7 device information including updating <a href="#">Table 1-1</a>, adding <a href="#">Table 1-3</a>, <a href="#">Table 1-7</a>, <a href="#">Table 2-1</a>, and <a href="#">Table 3-1</a>.</p> <p>Clarified the interposer in <a href="#">Figure 1-12</a> and <a href="#">Figure 1-11</a>. Revised horizontal center for the XC7VX415T in <a href="#">Figure 1-13</a>. Updated the <a href="#">DXP_0</a>, <a href="#">DXN_0</a> description and notes in <a href="#">Table 1-11</a>. Added devices to the <a href="#">Die Level Bank Numbering Overview</a> section. Clarified the <a href="#">I/O banks summary</a> section.</p> <p>Added Artix-7 device diagrams in the CSG324 package. Added XC7V585T device diagrams <a href="#">Figure 3-69</a> through <a href="#">Figure 3-76</a>.</p> <p>Moved AD4P/N, AD12P/N, and AD5P/N pins from [IO_L2P_T0_35:IO_L4N_T0_35] to [IO_L1P_T0_35:IO_L3N_T0_35] in <a href="#">Figure 3-77</a>, <a href="#">Figure 3-81</a>, <a href="#">Figure 3-101</a>, <a href="#">Figure 3-105</a>, <a href="#">Figure 3-109</a>, <a href="#">Figure 3-113</a>, and <a href="#">Figure 3-117</a>.</p> <p>Fixed the labeling for EMCCLK in <a href="#">Figure 3-61</a>, <a href="#">Figure 3-69</a>, <a href="#">Figure 3-77</a>, <a href="#">Figure 3-81</a>, <a href="#">Figure 3-101</a>, <a href="#">Figure 3-105</a>, <a href="#">Figure 3-109</a>, <a href="#">Figure 3-113</a>, and <a href="#">Figure 3-117</a>.</p> <p>Updated the mechanical drawings for <a href="#">Figure 4-31</a> and <a href="#">Figure 4-33</a>.</p> <p>Updated thermal resistance data in <a href="#">Table 5-1</a>.</p> <p>Updated <a href="#">Chapter 6, Package Marking</a>.</p>
10/17/2011	1.4	<p>Revised the <a href="#">FBG484 Package</a> section describing <a href="#">XC7K160T Banks</a>.</p> <p>Added the mechanical drawings: <a href="#">Figure 4-31</a> and <a href="#">Figure 4-34</a>. Updated <a href="#">Figure 4-33</a> to include the FF(G)1928 package.</p> <p>Added thermal resistance data to <a href="#">Table 5-1</a>.</p>
02/03/2012	1.5	<p>Updated <a href="#">Table 1-3</a> and <a href="#">Table 1-5</a> and added <a href="#">Table 1-6</a>. Updated <a href="#">Table 1-7</a> and <a href="#">Table 1-8</a> and added <a href="#">Table 1-9</a>. Revised <a href="#">Note 2</a> in <a href="#">Table 1-11</a>. Removed <a href="#">Figures 1-1</a> and <a href="#">1-2</a> along with references to the XC7A8, XC7A15, XC7A30T, and XC7A50T. Added <a href="#">Figure 1-2</a> and <a href="#">Figure 1-3</a>. Clarified <a href="#">Figure 1-6</a> though <a href="#">Figure 1-9</a>, <a href="#">Figure 1-11</a>, <a href="#">Figure 1-15</a>, and <a href="#">Figure 1-18</a>.</p> <p>Updated <a href="#">Table 2-3</a> and added <a href="#">Table 2-4</a>.</p> <p>Added devices to <a href="#">Table 3-1</a> and revised <a href="#">Table 3-2</a> (XC7K420T and XC7K480T). Updated <a href="#">Table 3-3</a> and added <a href="#">Table 3-4</a> and <a href="#">Table 3-5</a>.</p> <p>Revised specifications in:</p> <ul style="list-style-type: none"> <li>• <a href="#">Figure 4-14</a>: FB/FBG484 Flip-Chip Lidless BGA (Kintex-7 FPGAs) (1.0 mm Pitch)</li> <li>• <a href="#">Figure 4-17</a>: FB/FBG676 Flip-Chip Lidless BGA (Kintex-7 FPGAs) (1.0 mm Pitch).</li> <li>• <a href="#">Figure 4-22</a>: FB/FBG900 Flip-Chip Lidless BGA (Kintex-7 FPGAs) (1.0 mm Pitch) and combined with <a href="#">Figure 4-6</a>.</li> <li>• <a href="#">Figure 4-30</a>: FF/FFG1157 and FF/FFG1158 Flip-Chip BGA (Virtex-7 FPGAs) (1.0 mm Pitch).</li> </ul> <p>Added thermal resistance data to <a href="#">Table 5-1</a> and added <a href="#">Soldering Guidelines</a> section.</p> <p>Added <a href="#">Appendix B</a>.</p>

Date	Version	Revision
05/24/2012	1.6	<p>Removed the FFG1933 and FLG1933 packages throughout. Added the FLG1926 package where appropriate.</p> <p>Updated the <a href="#">Introduction in Chapter 1</a>. Updated XC7K420T in <a href="#">Table 1-9</a>. Added <a href="#">Note 7 to Table 1-11</a>. Updated the description and figure in the <a href="#">XC7K420T Banks</a> and <a href="#">XC7VX550T Banks</a> sections.</p> <p>Updated <a href="#">Figure 3-22</a>, <a href="#">Figure 3-26</a>, <a href="#">Figure 3-30</a>, and <a href="#">Figure 3-34</a>. Added <a href="#">Figure 3-145</a> through <a href="#">Figure 3-148</a>.</p> <p>Added <a href="#">Figure 4-6: FB/FBG676 Flip-Chip Lidless BGA Package Specifications for Artix-7 FPGAs</a>. Revised specifications and added capacitor location figures for:</p> <ul style="list-style-type: none"> <li>• <a href="#">Figure 4-17: FB/FBG676 Flip-Chip Lidless BGA Package Specifications for Kintex-7 FPGAs</a> <ul style="list-style-type: none"> <li>• <a href="#">Figure 4-20: XC7K325T FB/FBG676 Die Dimensions with Capacitor Locations</a></li> <li>• <a href="#">Figure 4-21: XC7K410T FB/FBG676 Die Dimensions with Capacitor Locations</a></li> </ul> </li> <li>• <a href="#">Figure 4-22: FB/FBG900 Flip-Chip Lidless BGA Package Specifications for Kintex-7 FPGAs</a> <ul style="list-style-type: none"> <li>• <a href="#">Figure 4-23: XC7K325T FB/FBG900 Die Dimensions with Capacitor Locations</a></li> <li>• <a href="#">Figure 4-24: XC7K410T FB/FBG900 Die Dimensions with Capacitor Locations</a></li> </ul> </li> <li>• <a href="#">Figure 4-27: FF/FFG1156 Flip-Chip BGA Package Specification for Kintex-7 FPGAs</a></li> <li>• <a href="#">Figure 4-30: FF/FFG1157 and FF/FFG1158 Flip-Chip BGA Package Specification for Virtex-7 FPGAs</a></li> </ul> <p>Added <a href="#">Thermal Management Strategy</a>, <a href="#">Some Thermal Management Options</a>, and updated <a href="#">Soldering Guidelines</a> in <a href="#">Chapter 5</a>.</p> <p>Updated <a href="#">Table A-1</a>.</p>
07/20/2012	1.7	<p>In <a href="#">Table 1-11</a>, updated the <a href="#">Other Pins</a> section.</p> <p>Added the XC7VH290T, XC7VH580T, and XC7VH870T and associated HCG packages to all appropriate chapters, tables, and figures. Added the SBG484 package for the XC7A200T devices to all appropriate chapters, tables, and figures.</p> <p>Updated the XC7VX1140T-FLG1926 headings in <a href="#">Table 2-4</a>, <a href="#">Figure 3-145</a> through <a href="#">Figure 3-148</a>, and <a href="#">Figure 4-34</a>.</p> <p>Updated GTP Quad numbers in <a href="#">Figure 1-1</a>, <a href="#">Figure 3-10</a>, and <a href="#">Figure 3-14</a>. Also added numbers to <a href="#">Figure 3-13</a> and <a href="#">Figure 3-16</a>. Updated the XC7V585T-FFG1761 figures: <a href="#">Figure 3-73</a> and <a href="#">Figure 3-76</a>.</p> <p>Added new mechanical drawings for the <a href="#">Artix-7 FPGAs in Chapter 4</a> along with <a href="#">Figure 4-19</a>, <a href="#">Figure 4-35</a>, and <a href="#">Figure 4-36</a>, and updated <a href="#">Figure 4-26</a>.</p> <p>In <a href="#">Table 5-1</a>, updated data throughout and added XC7VX1140T (FL1926) and XC7VH580T data.</p> <p>Added <a href="#">Figure 6-3: Artix-7 Device Package Marking</a>.</p>
10/15/2012	1.8	<p>Removed the following devices: XC7A350T, XC7V1500T, XC7VH290T.</p> <p>Added <a href="#">Figure 4-18</a> and updated drawing in <a href="#">Figure 4-19</a>. Added <a href="#">Note 5 to Figure 4-30</a>. Updated A2 dimension in <a href="#">Figure 4-33</a>. Updated aaa dimension in <a href="#">Figure 4-32</a> and <a href="#">Figure 4-34</a>.</p> <p>Updated the <a href="#">JEDEC Moisture Sensitivity Level (MSL)</a> for the <a href="#">Flip-Chip</a> packages on <a href="#">page 257</a>.</p>

Date	Version	Revision
02/14/2013	1.9	<p>Clarified pins in <a href="#">Figure 3-25</a>.</p> <p>Updated <a href="#">Figure 4-10</a> and <a href="#">Figure 4-14</a> and added <a href="#">Figure 4-15</a> and <a href="#">Figure 4-16</a>. Revised <a href="#">Figure 4-26</a> and <a href="#">Figure 4-30</a>.</p> <p>In <a href="#">Table 5-1</a>, updated data for <a href="#">Artix-7 FPGAs</a>, <a href="#">XC7K160T FF/FFG676</a>, <a href="#">Virtex-7 T FPGAs</a> and <a href="#">XC7VX1140T</a>.</p> <p>Updated <a href="#">Appendix B</a>.</p>
11/15/2013	1.10	<p>Updated disclaimer on <a href="#">page 2</a>.</p> <p>Added the XQ devices and RB/RF/RS package information throughout document.</p> <p>Added <a href="#">Note 1</a> to <a href="#">Table 1-2</a> and <a href="#">Note 6</a> to <a href="#">Table 1-11</a>. Revised the super logic region numbers in <a href="#">Figure 1-20</a>.</p> <p>Removed the Virtex-7 HT devices (HCG packages). Before removal, revised the super logic region numbers in <a href="#">Figure 1-20</a>: <a href="#">XC7VH870T Banks</a>. For packaging and pinout information on the Virtex-7 HT devices see <a href="http://www.xilinx.com/member/gtz/index.htm">www.xilinx.com/member/gtz/index.htm</a>.</p> <p>Updated the legend in <a href="#">Figure 3-77</a>, <a href="#">Figure 3-80</a>, <a href="#">Figure 3-81</a>, <a href="#">Figure 3-84</a>, <a href="#">Figure 3-145</a>, <a href="#">Figure 3-148</a>, <a href="#">Figure 3-149</a>, <a href="#">Figure 3-152</a>, <a href="#">Figure 3-153</a>, and <a href="#">Figure 3-156</a>.</p> <p>Updated the A and A2 dimensions in <a href="#">Figure 4-10: FF/FFG1156 Flip-Chip BGA Package Specification for Artix-7 FPGAs</a>, <a href="#">page 214</a>.</p> <p>Added <a href="#">Note 1</a> and updated the data in <a href="#">Table 5-1</a>. Updated the <a href="#">Pb-Free Reflow Soldering in Chapter 5</a> discussion.</p> <p>Removed the engineering sample notation from the top mark drawings in <a href="#">Figure 6-1</a>, <a href="#">Figure 6-2</a>, and <a href="#">Figure 6-3</a>. Updated the L2E description in <a href="#">Table 6-1</a>.</p> <p>Updated <a href="#">Appendix A</a>.</p>



# Table of Contents

---

Revision History .....	2
<b>Preface: About This Guide</b>	
Guide Contents .....	13
Additional Resources .....	13
<b>Chapter 1: Packaging Overview</b>	
Summary .....	15
Introduction .....	15
Device/Package Combinations and Maximum I/Os .....	16
Serial Transceiver Channels by Device/Package .....	18
Pin Definitions .....	24
Pin Compatibility Between Packages .....	28
Die Level Bank Numbering Overview .....	29
Banking and Clocking Summary .....	29
XC/XQ7A100T Bank .....	30
FTG256 Package .....	30
CSG324 Package .....	30
FGG484 Package .....	30
FGG676 Package .....	30
XC/XQ7A200T Banks .....	31
SBG484 and RS484 Package .....	31
FBG484 and RB484 Packages .....	31
FBG676 and RB676 Packages .....	31
FBG1156 Package .....	31
XC7K70T Banks .....	32
FBG484 Package .....	32
FBG676 Package .....	32
XC7K160T Banks .....	33
FBG484 Package .....	33
FBG676 and FFG676 Packages .....	33
XC/XQ7K325T Banks .....	34
FBG676, FFG676, and RF676 Packages .....	34
FBG900, FFG900, and RF900 Packages .....	34
XC7K355T Banks .....	35
FFG901 Package .....	35
XC/XQ7K410T Banks .....	36
FBG676, FFG676, and RF676 Packages .....	36
FBG900, FFG900, and RF900 Packages .....	36
XC7K420T Banks .....	37
FFG901 Package .....	37
FFG1156 Package .....	37
XC7K480T Banks .....	38
FFG901 Package .....	38
FFG1156 Package .....	38

XC/XQ7V585T Banks . . . . .	39
FFG1157 and RF1157 Packages . . . . .	39
FFG1761 and RF1761 Packages . . . . .	39
XC7V2000T Banks . . . . .	40
FHG1761 Package . . . . .	40
FLG1925 Package . . . . .	40
XC/XQ7VX330T Banks . . . . .	42
FFG1157 and RF1157 Packages . . . . .	42
FFG1761 and RF1761 Packages . . . . .	42
XC7VX415T Banks . . . . .	43
FFG1157 Package . . . . .	43
FFG1158 Package . . . . .	43
FFG1927 Package . . . . .	43
XC/XQ7VX485T Banks . . . . .	44
FFG1157 Package . . . . .	44
FFG1158 Package . . . . .	44
FFG1761 and RF1761 Packages . . . . .	44
FFG1927 Package . . . . .	44
FFG1930 and RF1930 Packages . . . . .	44
XC7VX550T Banks . . . . .	46
FFG1158 Package . . . . .	46
FFG1927 Package . . . . .	46
XC/XQ7VX690T Banks . . . . .	47
FFG1157 and RF1157 Packages . . . . .	47
FFG1158 Package . . . . .	47
FFG1761 and RF1761 Packages . . . . .	47
FFG1926 Package . . . . .	47
FFG1927 Package . . . . .	47
FFG1930 and RF1930 Packages . . . . .	47
XC/XQ7VX980T Banks . . . . .	49
FFG1926 Package . . . . .	49
FFG1928 Package . . . . .	49
FFG1930 and RF1930 Packages . . . . .	49
XC7VX1140T Banks . . . . .	51
FLG1926 Package . . . . .	51
FLG1928 Package . . . . .	51
FLG1930 Package . . . . .	51

## Chapter 2: 7 Series FPGAs Package Files

About ASCII Package Files . . . . .	53
ASCII Pinout Files . . . . .	54

## Chapter 3: Device Diagrams

Summary . . . . .	57
<b>Artix-7 FPGAs Device Diagrams.</b> . . . . .	58
CS/CSG324 Packages—7A100T . . . . .	58
FTG256 Package—7A100T . . . . .	61
FG/FGG484 Packages—7A100T . . . . .	63
FGG676 Package—7A100T . . . . .	66
SBG484/RB484 Packages—7A200T . . . . .	69
FBG484/RB484 Packages—7A200T . . . . .	72



FBG676/RB676 Packages—7A200T .....	75
FFG1156 Package—7A200T .....	78
<b>Kintex-7 FPGAs Device Diagrams .....</b>	<b>82</b>
FB/FBG484 Packages—7K70T and 7K160T .....	82
FB/FBG676 Packages—7K70T .....	85
FB/FBG676 Packages—7K160T, 7K325T, and 7K410T .....	88
FB/FBG900 Packages—7K325T and 7K410T .....	91
FF/FFG676 or RF676 Packages—7K160T, 7K325T, and 7K410T .....	95
FF/FFG900 and RF900 Packages—7K325T and 7K410T .....	98
FF/FFG901 Packages—7K355T .....	102
FF/FFG901 Packages—7K420T and 7K480T .....	106
FF/FFG1156 Packages—7K420T and 7K480T .....	110
<b>Virtex-7 FPGAs Device Diagrams .....</b>	<b>114</b>
FF/FFG1157 and RF1157 Packages—7V585T .....	115
FF/FFG1761 and RF1761 Packages—7V585T .....	119
FL/FLG1925 Packages—7V2000T .....	123
FH/FHG1761 Packages—7V2000T .....	127
FF/FFG1157 and RF1157 Packages—7VX330T, 7VX415T, and 7VX690T .....	131
FF/FFG1761 and RF1761 Packages—7VX330T .....	135
FF/FFG1158 Packages—7VX415T, 7VX550T, and 7VX690T .....	139
FF/FFG1927 Packages—7VX415T .....	143
FF/FFG1157 Packages—7VX485T .....	147
FF/FFG1158 Packages—7VX485T .....	151
FF/FFG1761 and RF1761 Packages—7VX485T .....	155
FF/FFG1927 Packages—7VX485T .....	159
FF/FFG1930 and RF1930 Packages—7VX485T .....	163
FF/FFG1761 and RF1761 Packages—7VX690T .....	167
FF/FFG1926 Packages—7VX690T and 7VX980T .....	171
FF/FFG1927 Packages—7VX550T and 7VX690T .....	175
FF/FFG1930 and RF1930 Packages—7VX690T .....	179
FF/FFG1928 Packages—7VX980T .....	183
FF/FFG1930 and RF1930 Packages—7VX980T .....	187
FL/FLG1926 Packages—7VX1140T .....	191
FL/FLG1928 Packages—7VX1140T .....	195
FL/FLG1930 Packages—7VX1140T .....	199

## Chapter 4: Mechanical Drawings

<b>Summary .....</b>	<b>203</b>
Artix-7 FPGAs .....	203
Kintex-7 FPGAs .....	203
Virtex-7 FPGAs .....	204
<b>CS/CSG324 Wire-Bond Chip-Scale BGA (Artix-7 FPGAs)</b>	
<b>(0.8 mm Pitch) .....</b>	<b>205</b>
<b>FTG256 Wire-Bond Fine-Pitch Thin BGA (Artix-7 FPGAs)</b>	
<b>(1.0 mm Pitch) .....</b>	<b>206</b>
<b>SBG484 Flip-Chip Lidless BGA (Artix-7 FPGAs)</b>	
<b>(0.8 mm Pitch) .....</b>	<b>207</b>
<b>FB/FBG484 Flip-Chip Lidless BGA (Artix-7 FPGAs)</b>	
<b>(1.0 mm Pitch) .....</b>	<b>208</b>
<b>FB/FBG676 Flip-Chip Lidless BGA (Artix-7 FPGAs)</b>	
<b>(1.0 mm Pitch) .....</b>	<b>210</b>

<b>FG/FGG484 Wire-Bond Fine-Pitch BGA (Artix-7 FPGAs) (1.0 mm Pitch)</b> .....	212
<b>FG/FGG676 Wire-Bond Fine-Pitch BGA (Artix-7 FPGAs) (1.0 mm Pitch)</b> .....	213
<b>FF/FFG1156 Flip-Chip BGA (Artix-7 FPGAs) (1.0 mm Pitch)</b> .....	214
<b>RB484 Ruggedized Flip-Chip BGA (Artix-7 FPGAs) (1.0 mm Pitch)</b> .....	215
<b>RS484 Ruggedized Flip-Chip BGA (Artix-7 FPGAs) (1.0 mm Pitch)</b> .....	216
<b>RB676 Ruggedized Flip-Chip BGA (Artix-7 FPGAs) (1.0 mm Pitch)</b> .....	217
<b>FB/FBG484 Flip-Chip Lidless BGA (Kintex-7 FPGAs) (1.0 mm Pitch)</b> .....	218
<b>FB/FBG676 Flip-Chip Lidless BGA (Kintex-7 FPGAs) (1.0 mm Pitch)</b> .....	221
<b>FB/FBG900 Flip-Chip Lidless BGA (Kintex-7 FPGAs) (1.0 mm Pitch)</b> .....	226
<b>FF/FFG676 Flip-Chip BGA (Kintex-7 FPGAs) (1.0 mm Pitch)</b> .....	229
<b>FF/FFG900 and FF/FFG901 Flip-Chip BGA (Kintex-7 FPGAs) (1.0 mm Pitch)</b> .....	230
<b>FF/FFG1156 Flip-Chip BGA (Kintex-7 FPGAs) (1.0 mm Pitch)</b> .....	231
<b>RF676 Flip-Chip BGA (Kintex-7 FPGAs) (1.0 mm Pitch)</b> .....	232
<b>RF900 Flip-Chip BGA (Kintex-7 FPGAs) (1.0 mm Pitch)</b> .....	233
<b>FF/FFG1157 and FF/FFG1158 Flip-Chip BGA (Virtex-7 FPGAs) (1.0 mm Pitch)</b> .....	234
<b>FF/FFG1761 Flip-Chip BGA (Virtex-7 FPGAs) (1.0 mm Pitch)</b> .....	235
<b>FH/FHG1761 Flip-Chip BGA (Virtex-7 T FPGAs) (1.0 mm Pitch)</b> .....	236
<b>FF/FFG1926, FF/FFG1927, FF/FFG1928, and FF/FFG1930 Flip-Chip BGA (Virtex-7 XT FPGAs) (1.0 mm Pitch)</b> .....	237
<b>FL/FLG1925, FL/FLG1926, FL/FLG1928, and FL/FLG1930 Flip-Chip BGA (Virtex-7 FPGAs) (1.0 mm Pitch)</b> .....	238
<b>RF1157 Flip-Chip BGA (Virtex-7 FPGAs) (1.0 mm Pitch)</b> .....	239
<b>RF1761 Flip-Chip BGA (Virtex-7 FPGAs) (1.0 mm Pitch)</b> .....	240
<b>RF1930 Flip-Chip BGA (Virtex-7 FPGAs) (1.0 mm Pitch)</b> .....	241

## Chapter 5: Thermal Specifications

Summary .....	243
---------------	-----

<b>Introduction</b> .....	243
<b>Thermal Management Strategy</b> .....	247
Design and Silicon .....	247
Cavity-Up Plastic BGA Packages .....	248
Wire-Bond Packages .....	249
Flip-Chip Packages .....	249
Heat Sink Solutions at the System Level .....	250
<b>Some Thermal Management Options</b> .....	251
<b>Support for Compact Thermal Models (CTM)</b> .....	252
<b>Soldering Guidelines</b> .....	254
Sn/Pb Reflow Soldering .....	254
Pb-Free Reflow Soldering .....	255
<b>References</b> .....	258

## Chapter 6: Package Marking

## Appendix A: Recommended PCB Design Rules for BGA Packages

## Appendix B: Heat Sink Guidelines for Lidless Flip-Chip Packages

<b>Heat Sink Attachments for Lidless FCBGA (FB/FBG)</b> .....	265
Silicon and Decoupling Capacitors Height Consideration .....	265
<b>Types of Heat Sink Attachments</b> .....	265
Heat Sink Attachment .....	267
Component Pick-up Tool Consideration .....	267
Heat Sink Attachment Process Considerations .....	267
Package Loading Specifications .....	269
<b>Reasons for Thermal Interface Material</b> .....	270
Types of TIM .....	270
Guidelines for Thermal Interface Materials .....	270
Thermal Conductivity of the Material .....	270
Electrical Conductivity of the Material .....	271
Spreading Characteristics of the Material .....	271
Long-Term Stability and Reliability of the Material .....	271
Ease of Application .....	271
Comparing the Types of Interface Materials .....	271
Thermal Grease .....	271
Thermal Gel .....	272
Thermal Conductive Compound .....	272
Thermally Conductive Elastomeric Pads .....	273
Thermal Tapes .....	273
Phase Change Materials .....	273
<b>Thermal Material Handling Guidelines</b> .....	274



## About This Guide

---

Xilinx® 7 series FPGAs include three unified FPGA families that are all designed for lowest power to enable a common design to scale across families for optimal power, performance, and cost. The Artix®-7 family is optimized for lowest cost and absolute power for the highest volume applications. The Virtex®-7 family is optimized for highest system performance and capacity. The Kintex®-7 family is an innovative class of FPGAs optimized for the best price-performance. This guide serves as a technical reference describing the 7 series packaging and pinout specifications.

This 7 series packaging and pinout specification, part of an overall set of documentation on the 7 series FPGAs, is available on the Xilinx website at [www.xilinx.com/7](http://www.xilinx.com/7).

### Guide Contents

This manual contains the following chapters:

- [Chapter 1, Packaging Overview](#)
- [Chapter 2, 7 Series FPGAs Package Files](#)
- [Chapter 3, Device Diagrams](#)
- [Chapter 4, Mechanical Drawings](#)
- [Chapter 5, Thermal Specifications](#)
- [Chapter 6, Package Marking](#)
- [Appendix A, Recommended PCB Design Rules for BGA Packages](#)

### Additional Resources

To find additional documentation, see the Xilinx website at:

<http://www.xilinx.com/support/documentation/index.htm>.

To search the Answer Database of silicon, software, and IP questions and answers, or to create a technical support WebCase, see the Xilinx website at:

<http://www.xilinx.com/support>.



# Packaging Overview

---

## Summary

This chapter covers the following topics:

- [Introduction](#)
- [Device/Package Combinations and Maximum I/Os](#)
- [Pin Definitions](#)
- [Pin Compatibility Between Packages](#)
- [Die Level Bank Numbering Overview](#)

## Introduction

This section describes the pinouts for the 7 series FPGAs in various fine pitch and flip-chip 1.0 mm pitch BGA packages and 0.8 mm pitch chip scale packages.

Artix®-7 and Kintex®-7 devices are offered in low-cost, space-saving packages that are optimally designed for the maximum number of user I/Os.

Virtex®-7 T and Virtex-7 XT devices are offered exclusively in high performance flip-chip BGA packages that are optimally designed for improved signal integrity and jitter.

For pinout and packaging information on the Virtex-7 HT devices see [www.xilinx.com/member/gtz/index.htm](http://www.xilinx.com/member/gtz/index.htm).

Package inductance is minimized as a result of optimal placement and even distribution as well as an increased number of Power and GND pins.

All packages are available as Pb-free (additional G in package name) with selected packages including a Pb-only option.

All of the 7 series devices supported in a particular package are pinout compatible. See [Pin Compatibility Between Packages, page 28](#). Pins that are available in a device but are not available in a smaller device with a compatible package are listed as “No Connects”.

Each device is split into I/O banks to allow for flexibility in the choice of I/O standards (see [UG471, 7 Series FPGAs SelectIO Resources User Guide](#)). [Table 1-11](#) provides definitions for all pin types.

## Device/Package Combinations and Maximum I/Os

Table 1-1 shows the maximum number of user I/Os possible in the 7 series FPGAs BGA packages. Some devices are available in both Pb and Pb-free (additional G) packages as standard ordering options.

Table 1-1: 7 Series FPGAs Package Specifications

Packages <sup>(1)</sup>	Description	Package Specifications			
		Package Type	Pitch (mm)	Size (mm)	Maximum I/Os <sup>(2)</sup>
CSG324	Wire-bond chip-scale	BGA	0.8	15 x 15	210
FTG256	Wire-bond fine-pitch	BGA	1.0	17 x 17	170
FGG484		BGA	1.0	23 x 23	285
FGG676		BGA	1.0	27 x 27	300
SBG484	Flip-chip lidless	BGA	0.8	19 x 19	285
FB484/FBG484	Flip-chip lidless	BGA	1.0	23 x 23	285
RS484	Ruggedized flip-chip	BGA	0.8	19 x 19	285
RB484	Ruggedized flip-chip	BGA	1.0	23 x 23	285
FB676/FBG676	Flip-chip lidless	BGA	1.0	27 x 27	400
RB676	Ruggedized flip-chip	BGA	1.0	27 x 27	400
RF676	Ruggedized flip-chip fine-pitch	BGA	1.0	27 x 27	400
FB900/FBG900	Flip-chip lidless	BGA	1.0	31 x 31	500
RF900	Ruggedized flip-chip fine-pitch	BGA	1.0	31 x 31	500



Table 1-1: 7 Series FPGAs Package Specifications (Cont'd)

Packages <sup>(1)</sup>	Description	Package Specifications			
		Package Type	Pitch (mm)	Size (mm)	Maximum I/Os <sup>(2)</sup>
FF676/FFG676	Flip-chip fine-pitch	BGA	1.0	27 x 27	400
FF900/FFG900		BGA	1.0	31 x 31	500
FF901/FFG901		BGA	1.0	31 x 31	380
FF1156/FFG1156		BGA	1.0	35 x 35	600
FF1157/FFG1157		BGA	1.0	35 x 35	600
FF1158/FFG1158		BGA	1.0	35 x 35	350
FF1761/FFG1761		BGA	1.0	42.5 x 42.5	850
FF1926/FFG1926		BGA	1.0	45 x 45	720
FF1927/FFG1927		BGA	1.0	45 x 45	600
FF1928/FFG1928		BGA	1.0	45 x 45	480
FF1930/FFG1930		BGA	1.0	45 x 45	1000
FL1925/FLG1925		BGA	1.0	45 x 45	1200
FL1926/FLG1926		BGA	1.0	45 x 45	720
FL1928/FLG1928		BGA	1.0	45 x 45	480
FL1930/FLG1930		BGA	1.0	45 x 45	1100
FH1761/FHG1761		BGA	1.0	45 x 45	850
RF1157		Ruggedized flip-chip fine-pitch	BGA	1.0	35 x 35
RF1761	BGA		1.0	42.5 x 42.5	850
RF1930	BGA		1.0	45 x 45	1000

**Notes:**

1. Leaded package options (FFxxx/FBxxx) are available for the Kintex-7 XC7K160T, XC7K325T, XC7K355T, XC7K410T, XC7K420T, and XC7K480T devices.
2. The maximum I/O numbers do not include pins in the configuration Bank 0 (Table 1-2) or the GT serial transceivers.

Table 1-2 lists the 21 dedicated I/O pins.

Table 1-2: 7 Series FPGAs I/O Pins in the Dedicated Configuration Bank (Bank0)

DXP_0	VCCBATT_0	INIT_B_0	M0_0	TDO_0	TDI_0	GNDADC_0 <sup>(1)</sup>
DXN_0	DONE_0	VN_0	M1_0	TCK_0	VREFN_0	VCCADC_0 <sup>(1)</sup>
PROGRAM_B_0	CCLK_0	VP_0	M2_0	TMS_0	VREFP_0	CFGBVS_0

**Notes:**

1. In SSI technology devices, GNDADC and VCCADC do not have an \_0 in the pin name.

## Serial Transceiver Channels by Device/Package

Table 1-3 lists the quantity of GTP serial transceiver channels for the Artix-7 FPGAs.

Table 1-3: Serial Transceiver Channels (GTPs) by Device/Package (Artix-7 FPGAs)

Device	GTP Channels by Package										
	CSG324	FTG256	SBG484	FGG484	FGG676	FBG484	FBG676	FFG1156	RS484	RB484	RB676
XC7A100T	0	0	–	4	8	–	–	–	–	–	–
XC7A200T	–	–	4	–	–	4	8	16	–	–	–
XQ7A100T	0	–	–	4	–	–	–	–	–	–	–
XQ7A200T	–	–	–	–	–	–	–	–	4	4	8

Table 1-4 lists the quantity of GTX serial transceiver channels for the Kintex-7 FPGAs.

Table 1-4: Serial Transceiver Channels (GTXs) by Device/Package (Kintex-7 FPGAs)

Device	GTX Channels by Package								
	FBG484	FBG676	FBG900	FFG676	FFG900	FFG901	FFG1156	RF676	RF900
XC7K70T	4	8	–	–	–	–	–	–	–
XC7K160T	4	8	–	8	–	–	–	–	–
XC7K325T	–	8	16	8	16	–	–	–	–
XC7K355T	–	–	–	–	–	24	–	–	–
XC7K410T	–	8	16	8	16	–	–	–	–
XC7K420T	–	–	–	–	–	28	32	–	–
XC7K480T	–	–	–	–	–	28	32	–	–
XQ7K325T	–	–	–	–	–	–	–	8	16
XQ7K410T	–	–	–	–	–	–	–	8	16

Table 1-5 lists the quantity of GTX serial transceiver channels for the Virtex-7 T FPGAs.

Table 1-5: Serial Transceiver Channels (GTX) by Device/Package (Virtex-7 T FPGAs)

Device	FFG1157	FFG1761	FLG1925	FHG1761	RF1157	RF1761
XC7V585T	20	36	–	–	–	–
XC7V2000T	–	–	16	36	–	–
XQ7V585T	–	–	–	–	20	36

Table 1-6 lists the quantity of GTX and GTH serial transceiver channels for the Virtex-7 XT FPGAs. In all devices, a serial transceiver channel is one set of MGTRXP, MGTRXN, MGTTXP, and MGTTXN pins.

Table 1-6: Serial Transceiver Channels (GTX/GTH) by Device/Package (Virtex-7 XT FPGAs)

Device	FFG/RF		FFG		FFG/RF		FFG		FFG		FFG		FFG/RF		FLG		FLG		FLG	
	1157		1158		1761		1926		1927		1928		1930		1926		1928		1930	
	GTX	GTH	GTX	GTH	GTX	GTH	GTX	GTH	GTX	GTH	GTX	GTH	GTX	GTH	GTX	GTH	GTX	GTH	GTX	GTH
XC7VX330T	0	20	-	0	28	-	-	-	-	-	-	-	-	-	-	-	-	-	-	-
XC7VX415T	0	20	0	48	-	-	0	48	-	-	-	-	-	-	-	-	-	-	-	-
XC7VX485T	20	0	48	0	28	0	-	56	0	-	24	0	-	-	-	-	-	-	-	-
XC7VX550T	-	-	0	48	-	-	-	0	80	-	-	-	-	-	-	-	-	-	-	-
XC7VX690T	0	20	0	48	0	36	0	64	0	80	-	0	24	-	-	-	-	-	-	-
XC7VX980T	-	-	-	-	-	-	0	64	-	-	0	72	0	24	-	-	-	-	-	-
XC7VX1140T	-	-	-	-	-	-	-	-	-	-	-	-	-	0	64	0	96	0	24	-
XQ7VX330T	0	20	-	0	28	-	-	-	-	-	-	-	-	-	-	-	-	-	-	-
XQ7VX485T	-	-	-	28	0	-	-	-	-	-	24	0	-	-	-	-	-	-	-	-
XQ7VX690T	0	20	-	0	36	-	-	-	-	-	0	24	-	-	-	-	-	-	-	-
XQ7VX980T	-	-	-	-	-	-	-	-	-	-	0	24	-	-	-	-	-	-	-	-

Table 1-7 shows the number of available I/Os and the number of differential I/Os for each Artix-7 device/package combination.

Table 1-7: Available I/O Pin/Device/Package Combinations for Artix-7 FPGAs

Artix-7 Devices	User I/O Pins	Artix-7 FPGA Packages: HR I/O Banks Only									
		CSG324	FTG256	SBG484	FGG484	FGG676	FBG484	FBG676	FFG1156	RB/RS484	RB676
XC7A100T	User I/O	210	170	–	285	300	–	–	–	–	–
	Differential	202	163	–	274	288	–	–	–	–	–
XC7A200T	User I/O	–	–	285	–	–	285	400	500	–	–
	Differential	–	–	274	–	–	274	384	480	–	–
XQ7A100T	User I/O	210	–	–	285	–	–	–	–	–	–
	Differential	202	–	–	274	–	–	–	–	–	–
XQ7A200T	User I/O	–	–	–	–	–	–	–	–	285	400
	Differential	–	–	–	–	–	–	–	–	274	384

Table 1-8 shows the number of available I/Os and the number of differential I/Os for each Kintex-7 device/package combination.

Table 1-8: Available I/O Pin/Device/Package Combinations for Kintex-7 FPGAs

Kintex-7 Devices	User I/O Pins	Kintex-7 FPGA Packages: HR and HP I/O Banks																	
		FBG484		FBG676		FBG900		FFG676		FFG900		FFG901		FFG1156		RF676		RF900	
		HP	HR	HP	HR	HP	HR	HP	HR	HP	HR	HP	HR	HP	HR	HP	HR	HP	HR
XC7K70T	User I/O	100	185	100	200	-	-	-	-	-	-	-	-	-	-	-	-	-	-
	Differential	96	176	96	192	-	-	-	-	-	-	-	-	-	-	-	-	-	-
XC7K160T	User I/O	100	185	150	250	-	-	150	250	-	-	-	-	-	-	-	-	-	-
	Differential	96	176	144	240	-	-	144	240	-	-	-	-	-	-	-	-	-	-
XC7K325T	User I/O	-	-	150	250	150	350	150	250	150	350	-	-	-	-	-	-	-	-
	Differential	-	-	144	240	144	336	144	240	144	336	-	-	-	-	-	-	-	-
XC7K355T	User I/O	-	-	-	-	-	-	-	-	-	-	0	300	-	-	-	-	-	-
	Differential	-	-	-	-	-	-	-	-	-	-	0	288	-	-	-	-	-	-
XC7K410T	User I/O	-	-	150	250	150	350	150	250	150	350	-	-	-	-	-	-	-	-
	Differential	-	-	144	240	144	336	144	240	144	336	-	-	-	-	-	-	-	-
XC7K420T	User I/O	-	-	-	-	-	-	-	-	-	-	0	380	0	400	-	-	-	-
	Differential	-	-	-	-	-	-	-	-	-	-	0	366	0	384	-	-	-	-
XC7K480T	User I/O	-	-	-	-	-	-	-	-	-	-	0	380	0	400	-	-	-	-
	Differential	-	-	-	-	-	-	-	-	-	-	0	366	0	384	-	-	-	-
XQ7K325T	User I/O	-	-	-	-	-	-	-	-	-	-	-	-	-	-	150	250	150	350
	Differential	-	-	-	-	-	-	-	-	-	-	-	-	-	-	144	240	144	336
XQ7K410T	User I/O	-	-	-	-	-	-	-	-	-	-	-	-	-	-	150	250	150	350
	Differential	-	-	-	-	-	-	-	-	-	-	-	-	-	-	144	240	144	336

Table 1-9 and Table 1-10 show the number of available I/Os and the number of differential I/Os for each Virtex-7 device/package combination. When applicable, it also lists the number of user I/Os in the 3.3V-capable high-range (HR) banks and the number of 1.8V-capable high-performance (HP) banks.

Table 1-9: Available I/O Pin/Device/Package Combinations for Virtex-7 T FPGAs

Virtex-7 T Devices	User I/O Pins	Virtex-7 T FPGA Packages: HR and HP I/O Banks											
		FFG		FFG		FLG		FHG		RF		RF	
		1157		1761		1925		1761		1157		1761	
		HP	HR	HP	HR	HP	HR	HP	HR	HP	HR	HP	HR
XC7V585T	User I/O	600	0	750	100	–		–		–		–	
	Differential	576	0	720	96	–		–		–		–	
XC7V2000T	User I/O	–		–		1200	0	850	0	–		–	
	Differential	–		–		1152	0	816	0	–		–	
XQ7V585T	User I/O	–		–		–		–		600	0	750	100
	Differential	–		–		–		–		576	0	720	96

Table 1-10: Available I/O Pin/Device/Package Combinations for Virtex-7 XT FPGAs

Virtex-7 XT Devices	User I/O Pins	Virtex-7 XT FPGA Packages: HR and HP I/O Banks																			
		FFG/RF		FFG		FFG/RF		FFG		FFG		FFG		FFG/RF		FLG		FLG		FLG	
		1157		1158		1761		1926		1927		1928		1930		1926		1928		1930	
		HP	HR	HP	HR	HP	HR	HP	HR	HP	HR	HP	HR	HP	HR	HP	HR	HP	HR	HP	HR
XC7VX330T	User I/O	600	0	–		650	50	–		–		–		–		–		–		–	
	Differential	576	0	–		624	48	–		–		–		–		–		–		–	
XC7VX415T	User I/O	600	0	350	0	–		–		600	0	–		–		–		–		–	
	Differential	576	0	336	0	–		–		576	0	–		–		–		–		–	
XC7VX485T	User I/O	600	0	350	0	700	0	–		600	0	–		700	0	–		–		–	
	Differential	576	0	336	0	672	0	–		576	0	–		672	0	–		–		–	
XC7VX550T	User I/O	–		350	0	–		–		600	0	–		–		–		–		–	
	Differential	–		336	0	–		–		576	0	–		–		–		–		–	
XC7VX690T	User I/O	600	0	350	0	850	0	720	0	600	0	–		1000	0	–		–		–	
	Differential	576	0	336	0	816	0	690	0	576	0	–		960	0	–		–		–	
XC7VX980T	User I/O	–		–		–		720	0	–		480	0	900	0	–		–		–	
	Differential	–		–		–		690	0	–		460	0	864	0	–		–		–	
XC7VX1140T	User I/O	–		–		–		–		–		–		–		720	0	480	0	1100	0
	Differential	–		–		–		–		–		–		–		690	0	460	0	1056	0
XQ7VX330T	User I/O	600	0	–		650	50	–		–		–		–		–		–		–	
	Differential	576	0	–		624	48	–		–		–		–		–		–		–	

Table 1-10: Available I/O Pin/Device/Package Combinations for Virtex-7 XT FPGAs (Cont'd)

Virtex-7 XT Devices	User I/O Pins	Virtex-7 XT FPGA Packages: HR and HP I/O Banks																			
		FFG/RF		FFG		FFG/RF		FFG		FFG		FFG/RF		FLG		FLG		FLG			
		1157		1158		1761		1926		1927		1928		1930		1926		1928		1930	
		HP	HR	HP	HR	HP	HR	HP	HR	HP	HR	HP	HR	HP	HR	HP	HR	HP	HR	HP	HR
XQ7VX485T	User I/O	-	-	700	0	-	-	-	-	700	0	-	-	-	-	-	-	-	-		
	Differential	-	-	672	0	-	-	-	-	672	0	-	-	-	-	-	-	-	-		
XQ7VX690T	User I/O	600	0	-	850	0	-	-	-	1000	0	-	-	-	-	-	-	-			
	Differential	576	0	-	816	0	-	-	-	960	0	-	-	-	-	-	-	-			
XQ7VX980T	User I/O	-	-	-	-	-	-	-	-	900	0	-	-	-	-	-	-	-			
	Differential	-	-	-	-	-	-	-	-	864	0	-	-	-	-	-	-	-			

## Pin Definitions

Table 1-11 lists the pin definitions used in 7 series FPGAs packages.

**Note:** There are dedicated general purpose user I/O pins listed separately in Table 1-11. There are also multi-function pins where the pin names start with either IO\_LXXY\_ZZZ\_# or IO\_XX\_ZZZ\_#, where ZZZ represents one or more functions in addition to being general purpose user I/O. If not used for their special function, these pins can be user I/O.

Table 1-11: 7 Series FPGAs Pin Definitions

Pin Name	Type	Direction	Description
<b>User I/O Pins</b>			
IO_LXXY_# IO_XX_#	Dedicated	Input/ Output	Most user I/O pins are capable of differential signaling and can be implemented as pairs. The top and bottom I/O pins are always single ended. Each user I/O is labeled IO_LXXY_#, where: <ul style="list-style-type: none"> <li>IO indicates a user I/O pin.</li> <li>L indicates a differential pair, with XX a unique pair in the bank and Y = [P   N] for the positive/negative sides of the differential pair.</li> <li># indicates a bank number.</li> </ul>
<b>Configuration Pins</b>			
For more information, see the <i>Configuration Pin Definitions</i> table in <a href="#">UG470, 7 Series FPGAs Configuration User Guide</a> .			
CCLK_0	Dedicated <sup>(1)</sup>	Input/ Output	Configuration clock. Output in Master mode or input in Slave mode.
DONE_0	Dedicated <sup>(1)</sup>	Bidirectional	Active High, DONE indicates successful completion of configuration.
INIT_B_0	Dedicated <sup>(1)</sup>	Bidirectional (open-drain)	Active Low, indicates initialization of configuration memory.
M0_0, M1_0, or M2_0	Dedicated <sup>(1)</sup>	Input	Configuration mode selection.
PROGRAM_B_0	Dedicated <sup>(1)</sup>	Input	Active Low, asynchronous reset to configuration logic.
TCK_0	Dedicated <sup>(1)</sup>	Input	JTAG clock.
TDI_0	Dedicated <sup>(1)</sup>	Input	JTAG data input.
TDO_0	Dedicated <sup>(1)</sup>	Output	JTAG data output.
TMS_0	Dedicated <sup>(1)</sup>	Input	JTAG mode select.
CFGBVS_0	Dedicated <sup>(1)</sup>	Input	This pin selects the preconfiguration I/O standard type for the dedicated and multi-function configuration banks 0, 14, and 15. If the V <sub>CCO</sub> for banks 0, 14, or 15 is 2.5V or 3.3V, then this pin must be connect to V <sub>CCO_0</sub> . If the V <sub>CCO</sub> for banks 0, 14, and 15 are less than or equal to 1.8V, then this pin should be connected to GND. <p><b>Note:</b> To avoid device damage, this pin must be connected correctly. See the <i>Configuration Bank Voltage Select</i> section in <a href="#">UG470: 7 Series FPGAs Configuration User Guide</a> for more information.</p>
D00 through D31	Multi-function	Bidirectional	Configuration data pins.



Table 1-11: 7 Series FPGAs Pin Definitions (Cont'd)

Pin Name	Type	Direction	Description
ADV_B	Multi-function	Output	BPI Flash address valid output.
A00 through A28	Multi-function	Output	Address A00–A28 BPI address output.
RS0 or RS1	Multi-function	Output	RS0 and RS1 revision select output.
FCS_B	Multi-function	Output	BPI and SPI flash chip select.
FOE_B	Multi-function	Output	BPI flash output enable.
MOSI	Multi-function	Output	SPI flash command output. Also known as the SPI bus master output, slave input signal.
FWE_B	Multi-function	Output	BPI flash write enable.
DOUT	Multi-function	Output	Data output for serial daisy-chain configuration.
CSO_B	Multi-function	Output	Active Low chip-select output for parallel daisy-chain.
CSI_B	Multi-function	Input	SelectMAP active Low chip-select input.
PUDC_B	Multi-function	Input	Active Low input enables internal pull-ups during configuration on all SelectIO pins: 0 = Weak preconfiguration I/O pull-up resistors enabled 1 = Weak preconfiguration I/O pull-up resistors disabled
RDWR_B	Multi-function	Input	SelectMAP data bus direction control signal for reading or writing configuration data.
EMCCLK	Multi-function	Input	External master configuration clock.
<b>Power/Ground Pins</b>			
GND	Dedicated	N/A	Ground.
VCCAUX	Dedicated	N/A	1.8V power-supply pins for auxiliary circuits.
VCCAUX_IO_G# <sup>(2)</sup>	Dedicated	N/A	1.8V/2.0V power-supply pins for auxiliary I/O circuits.
VCCINT	Dedicated	N/A	0.9V/1.0V power-supply pins for the internal core logic.
VCCO_# <sup>(3)</sup>	Dedicated	N/A	Power-supply pins for the output drivers (per bank).
VCCBRAM	Dedicated	N/A	1.0V power-supply pins for the FPGA logic block RAM.
VCCBATT_0	Dedicated	N/A	Decryptor key memory backup supply; this pin should be tied to the appropriate V <sub>CC</sub> or GND when not used <sup>(4)</sup> .
VREF	Multi-function	N/A	These are input threshold voltage pins. They become user I/Os when an external threshold voltage is not needed (per bank).
<b>Analog to Digital Converter (XADC) Pins</b>			
For more information, see the <i>XADC Package Pins</i> table in <a href="#">UG480, 7 Series FPGAs XADC User Guide</a> .			
VCCADC_0 <sup>(5)(6)</sup>	Dedicated	N/A	XADC analog positive supply voltage.
GNDADC_0 <sup>(5)(6)</sup>	Dedicated	N/A	XADC analog ground reference.
VP_0 <sup>(5)</sup>	Dedicated	Input	XADC dedicated differential analog input (positive side).
VN_0 <sup>(5)</sup>	Dedicated	Input	XADC dedicated differential analog input (negative side).

Table 1-11: 7 Series FPGAs Pin Definitions (Cont'd)

Pin Name	Type	Direction	Description
VREFP_0 <sup>(5)</sup>	Dedicated	N/A	1.25V reference input.
VREFN_0 <sup>(5)</sup>	Dedicated	N/A	1.25V reference GND reference.
AD0P through AD15P AD0N through AD15N	Multi-function	Input	XADC (analog-to-digital converter) differential auxiliary analog inputs 0–15. Auxiliary channels 6, 7, 13, 14, and 15 are not supported on Kintex-7 devices.
<b>Multi-gigabit Serial Transceiver Pins (GTXE2 and GTHE2)</b>			
For more information on the GTXE2 and GTHE2 pins see the <i>Pin Description and Design Guidelines</i> section in <a href="#">UG476</a> , <i>7 Series FPGAs GTX/GTH Transceivers User Guide</i> .			
MGTXRX[0:3]	Dedicated	Input	Positive differential receive port GTX Quad.
MGTXRXN[0:3]	Dedicated	Input	Negative differential receive port GTX Quad.
MGTXTXP[0:3]	Dedicated	Output	Positive differential transmit port GTX Quad.
MGTXTXN[0:3]	Dedicated	Output	Negative differential transmit port GTX Quad.
MGTHRX[0:3]	Dedicated	Input	Positive differential receive port GTH Quad.
MGTHRXN[0:3]	Dedicated	Input	Negative differential receive port GTH Quad.
MGHTXP[0:3]	Dedicated	Output	Positive differential transmit port GTH Quad.
MGHTXN[0:3]	Dedicated	Output	Negative differential transmit port GTH Quad.
MGTAVCC_G# <sup>(7)</sup>	Dedicated	Input	1.0V analog power-supply pin for the receiver and transmitter internal circuits.
MGTAVTT_G# <sup>(7)</sup>	Dedicated	Input	1.2V analog power-supply pin for the transmit driver.
MGTVCCAUX_G# <sup>(7)</sup>	Dedicated	Input	1.8V auxiliary analog Quad PLL (QPLL) voltage supply for the transceivers.
MGTREFCLK0/1P	Dedicated	Input	Positive differential reference clock for the transceivers.
MGTREFCLK0/1N	Dedicated	Input	Negative differential reference clock for the transceivers.
MGTAVTTRCAL	Dedicated	N/A	Precision reference resistor pin for internal calibration termination. Not used for Artix-7 devices.
MGTRREF	Dedicated	Input	Precision reference resistor pin for internal calibration termination.
<b>Other Pins</b>			
MRCC	Multi-function	Input	These are the clock capable I/Os driving BUFMRs, BUFIOs, BUFGs, and MMCMs/PLLs. In addition, these pins can drive the BUFMR for multi-region BUFIO and BUFMR support. These pins become regular user I/Os when not needed as a clock. When connecting a single-ended clock to the differential CC pair of pins, it must be connected to the positive (P) side of the pair. The MRCC (multi-region) pins, when used as single region resource, can drive four BUFIOs and four BUFMR in a single bank.

Table 1-11: 7 Series FPGAs Pin Definitions (Cont'd)

Pin Name	Type	Direction	Description
SRCC	Multi-function	Input	These are the clock capable I/Os driving BUFRRs, BUFIOs, and MMCMs/PLLs. These pins become regular user I/Os when not needed for clocks. When connecting a single-ended clock to the differential CC pair of pins, it must be connected to the positive (P) side of the pair. The SRCC (single region) pins can drive four BUFIOs and four BUFRRs in a single bank.
VRN <sup>(8)</sup>	Multi-function	N/A	This pin is for the DCI voltage reference resistor of N transistor (per bank, to be pulled High with reference resistor).
VRP <sup>(8)</sup>	Multi-function	N/A	This pin is for the DCI voltage reference resistor of P transistor (per bank, to be pulled Low with reference resistor).
DXP_0, DXN_0	Dedicated	Input	Temperature-sensing diode pins (Anode: DXP; Cathode: DXN). The thermal diode is accessed by using the DXP and DXN pins in bank 0. When not used, tie to GND. To use the thermal diode an appropriate external thermal monitoring IC must be added. Consult the external thermal monitoring IC data sheet for usage guidelines. The recommended temperature monitoring solution for 7 series FPGAs uses the temperature sensor in the XADC block.
T0, T1, T2, or T3	Multi-function	Input	This pin belongs to the memory byte group 0-3.
T0_DQS, T1_DQS, T2_DQS, or T3_DQS	Multi-function	Input	The DDR DQS strobe pin that belongs to the memory byte group T0–T3.

**Notes:**

1. All dedicated pins (JTAG and configuration) are powered by V<sub>CCO\_0</sub>.
2. For devices that do not include VCCAUX\_IO\_G# pins, auxiliary I/O circuits are powered by VCCAUX pins. As indicated in [Chapter 2, 7 Series FPGAs Package Files](#), some packages include VCCAUX\_IO\_G# pins but also have auxiliary I/O circuits powered by VCCAUX pins. In this case, the VCCAUX\_IO\_G# pins exist for migration purposes only and will not connect to any internal circuitry.
3. V<sub>CCO</sub> pins in unbonded banks must be connected to the V<sub>CCO</sub> for that bank for package migration. Do NOT connect unbonded V<sub>CCO</sub> pins to different supplies. Without a package migration requirement, V<sub>CCO</sub> pins in unbonded banks can be tied to a common supply (V<sub>CCO</sub> or ground).
4. Refer to the data sheet for V<sub>CCBATT\_0</sub> specifications.
5. See [UG480, 7 Series FPGAs XADC User Guide](#) for the default connections required to support on-chip monitoring.
6. In SSI technology devices, GNDADC and VCCADC do not have an \_0 in the pin name.
7. In packages with only one MGT power group, the MGTAVCC\_G#, MGTAVTT\_G#, and MGTVCCAUX\_G# pins are labeled without the \_G#. These pins also appear without a number in the power and GND placement diagrams in [Chapter 3, Device Diagrams](#).
8. The DCI guidelines in the 7 series FPGAs are different from previous Virtex device DCI guidelines. See the DCI sections in [UG471: 7 Series FPGAs SelectIO Resources User Guide](#) for more information on the VRN/VRP pins.

## Pin Compatibility Between Packages

7 series FPGA devices are pin compatible only with other 7 series FPGA devices of the same family (Artix-7, Kintex-7, and Virtex-7) in the same package. In addition, FB/FBG, FF/FFG, FH/FHG, FL/FLG, RB, RF, and RS packages of the same pin-count designator are pin compatible.

**Note:** Pin compatible packages can have substantially different decoupling capacitor recommendations.

Some FB/FBG and RB packages include  $V_{CCAUX\_IO}$  pins that are not utilized by the I/O. These pins are placeholders to ensure pin compatibility with FF/FFG and RF packages. In the FF/FFG and RF packages, when the high-performance option is chosen for the HP I/O banks, the  $V_{CCAUX\_IO}$  pins must be connected to a separate power supply from  $V_{CCAUX}$ . Therefore, to allow for migration to the FF/FFG and RF packages,  $V_{CCAUX\_IO}$  must be connected to the appropriate voltage/regulator.

# Die Level Bank Numbering Overview

## Banking and Clocking Summary

- The center clocking backbone contains all vertical clock tracks and clock buffer connectivity.
- The CMT backbone contains all vertical CMT connectivity and is located in the CMT column.
- Not all banks are bonded out in every part/package combination.
- GTP/GTX/GTH columns summary
  - One GT Quad = Four transceivers = Four GTPE2 or GTXE2 or GTHE2 primitives.
  - Not all GT Quads are bonded out in every package.
- I/O banks summary
  - Each bank has four pairs of clock capable (CC) inputs for four differential or four single ended clock inputs.
    - Can connect to the CMT in the same region and the region above and below (with restrictions).
    - Two MRCC pairs can connect to the BUFRRs and BUFIOs in the same region/banks and the regions/banks above and below.
    - Two SRCC pairs can only connect to the BUFRRs and BUFIOs in the same region/bank.
    - There are no global clock pins (GC pins) in the 7 series FPGAs.
  - Each user I/O bank has 50 single-ended I/Os or 24 differential pairs (48 differential I/Os). The top and bottom I/O pin are always single ended. All 50 pads of a bank are not always bonded out to pins.
- Bank locations of dedicated and dual-purpose pins
  - In most devices, banks 14 and 15 always contain the dual-purpose configuration pins. Bank 15 and 35 contains the XADC auxiliary inputs; however, in Kintex-7 devices, the auxiliary inputs are only in bank 15. Bank 0 contains the dedicated configuration pins.
  - All dedicated configuration I/Os (bank 0) are 3.3V capable
- The physical XY locations for each IDELAYCTRL start at X0Y0 in the bottom left-most bank. The locations then increment by one starting with the lowest bank number in each column in the vertical Y direction and by one for each column in the horizontal X direction. IDELAYCTRLs are located in each of the HROWS.

Figure 1-1 through Figure 1-18 visually describe a die view of the FPGA bank numbering.

## XC/XQ7A100T Bank

Figure 1-1 shows the I/O and transceiver banks for the XC/XQ7A100T.

### FTG256 Package

- HR I/O banks 13 and 16 are not bonded out.
- HR I/O bank 34 is partially bonded out.
- The GTP Quads 213 and 216 are not bonded out.

### CSG324 Package

- HR I/O bank 13 is not bonded out.
- HR I/O bank 16 is partially bonded out.
- The GTP Quads 213 and 216 are not bonded out.

### FGG484 Package

- HR I/O bank 13 is partially bonded out.
- The GTP Quad 213 is not bonded out.

### FGG676 Package

- All HR I/O banks and the GTP Quads are fully bonded out in this package.

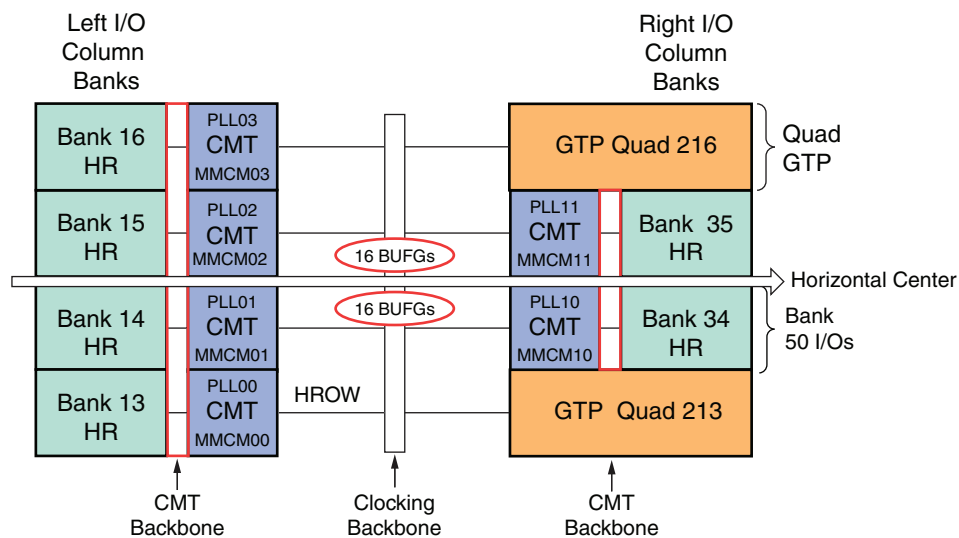

UG475\_c1\_03\_062712

Figure 1-1: XC/XQ7A100T Banks

## XC/XQ7A200T Banks

Figure 1-2 shows the I/O and transceiver banks for the XC/XQ7A200T.

### SBG484 and RS484 Package

- HR I/O bank 13 is partially bonded out.
- HR I/O banks 12, 32, 33, and 36 are not bonded out.
- The GTP Quads 113, 116, and 213 are not bonded out.

### FBG484 and RB484 Packages

- HR I/O bank 13 is partially bonded out.
- HR I/O banks 12, 32, 33, and 36 are not bonded out.
- The GTP Quads 113, 116, and 213 are not bonded out.

### FBG676 and RB676 Packages

- HR I/O banks 32 and 36 are not bonded out.
- The GTP Quads 113 and 116 are not bonded out.

### FBG1156 Package

- All HR I/O banks and the GTP Quads are fully bonded out in this package.

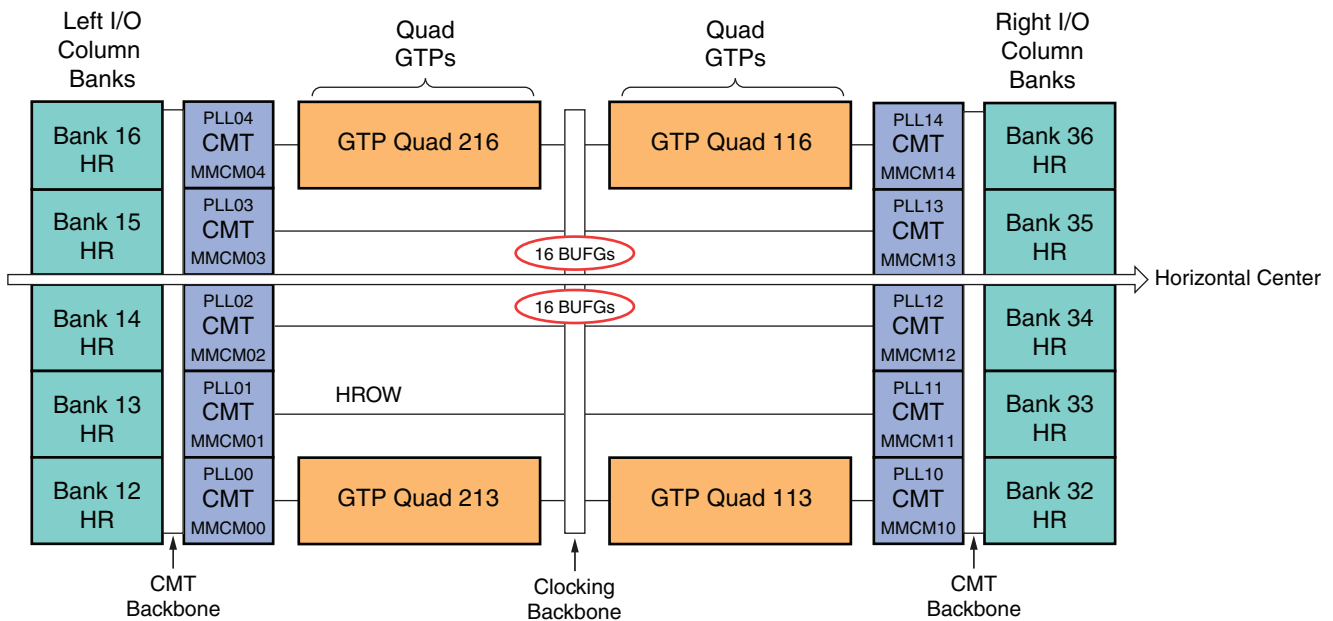

UG475\_c1\_04\_050212

Figure 1-2: XC/XQ7A200T Banks

## XC7K70T Banks

Figure 1-3 shows the I/O and transceiver banks for the XC7K70T.

### FBG484 Package

- HR I/O bank 16 is partially bonded out.
- All HP I/O banks are fully bonded out.
- The GTX Quad 116 is not bonded out.

### FBG676 Package

- All HR and HP I/O banks and the GTX Quads are fully bonded out in this package.

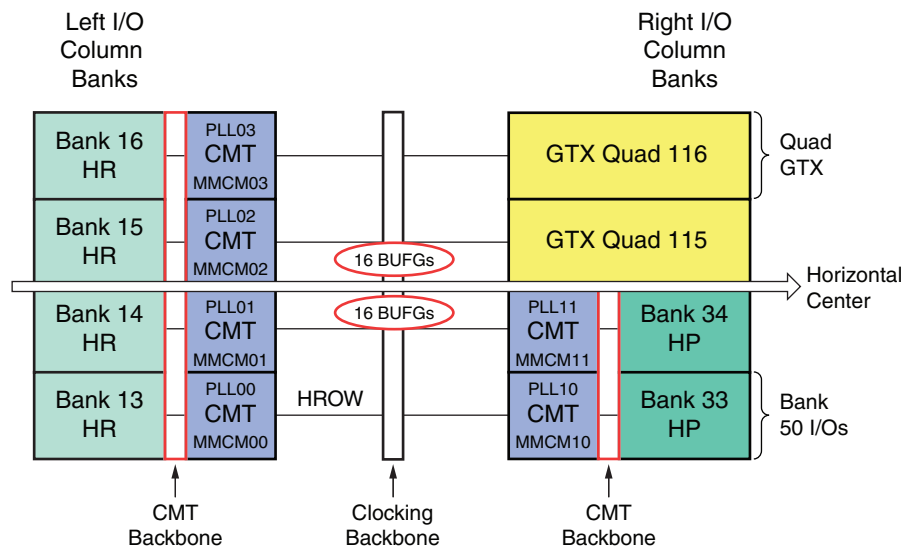

Figure 1-3: XC7K70T Banks



## XC7K160T Banks

Figure 1-4 shows the I/O and transceiver banks for the XC7K160T.

### FBG484 Package

- HR I/O bank 12 is not bonded out and bank 16 is partially bonded out.
- HP I/O bank 32 is not bonded out.
- The GTX Quad 116 is not bonded out.

### FBG676 and FFG676 Packages

- All HR and HP I/O banks and the GTX Quads are fully bonded out in these packages.

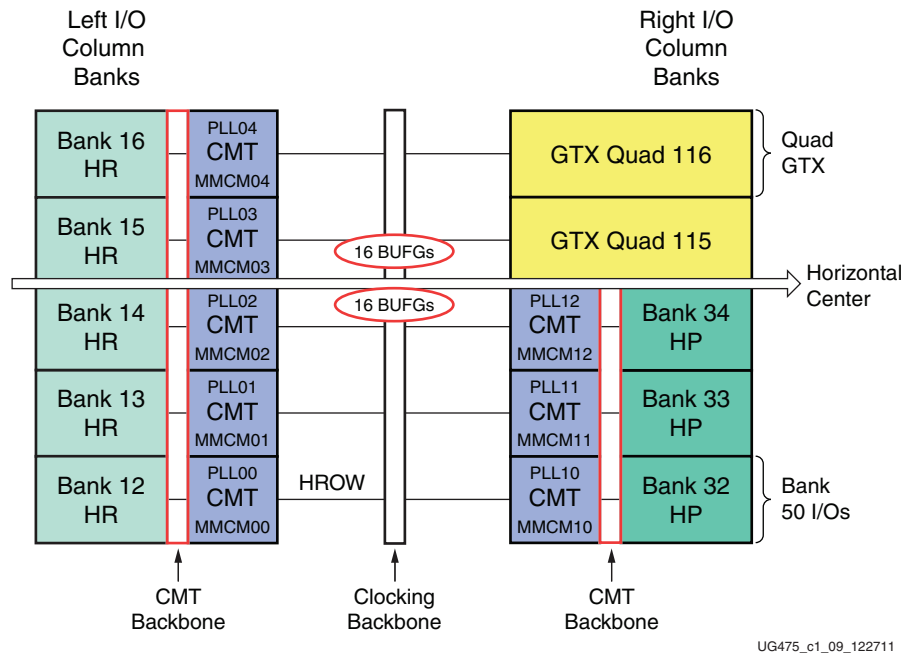

UG475\_c1\_09\_122711

Figure 1-4: XC7K160T Banks

## XC/XQ7K325T Banks

Figure 1-5 shows the I/O and transceiver banks for the XC/XQ7K325T.

### FBG676, FFG676, and RF676 Packages

- HR I/O banks 17 and 18 are not bonded out.
- All HP I/O banks are fully bonded out.
- GTX Quads 117 and 118 are not bonded out.

### FBG900, FFG900, and RF900 Packages

All HR and HP I/O banks and the GTX Quads are fully bonded out in these packages.

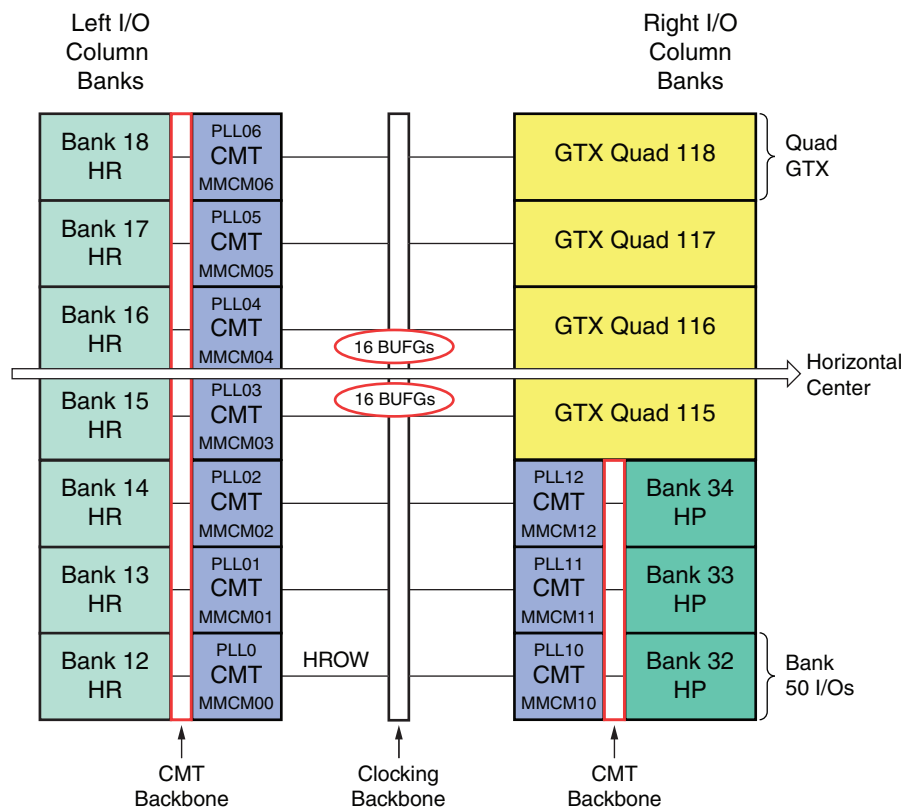

Figure 1-5: XC/XQ7K325T Banks

## XC7K355T Banks

Figure 1-6 shows the I/O and transceiver banks for the XC7K355T.

### FFG901 Package

All HR I/O banks and the GTX Quads are fully bonded out in this package.

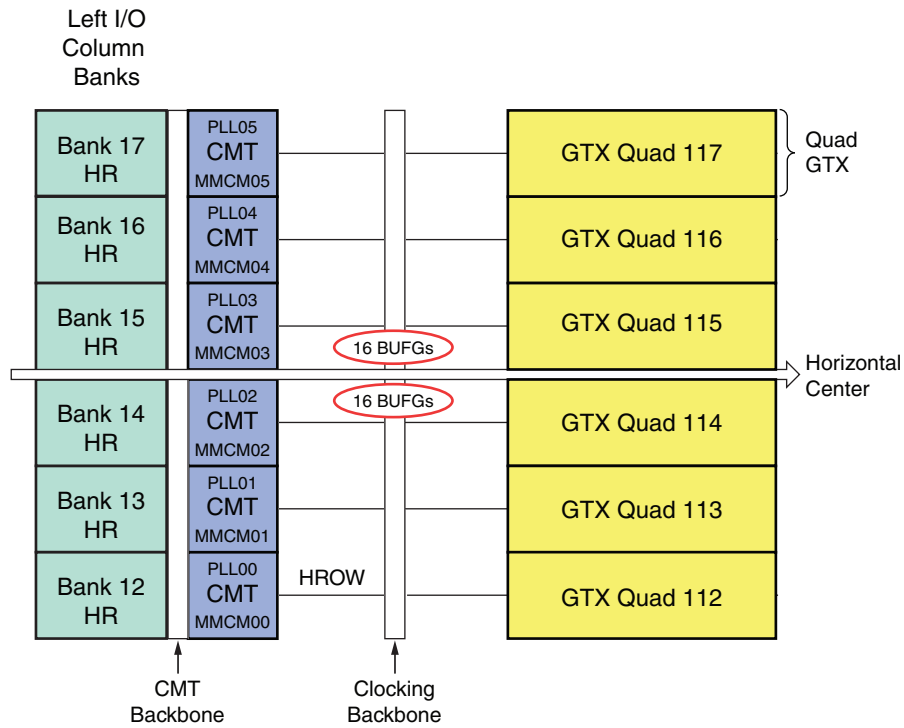

Figure 1-6: XC7K355T Banks

## XC/XQ7K410T Banks

Figure 1-7 shows the I/O and transceiver banks for the XC/XQ7K410T.

### FBG676, FFG676, and RF676 Packages

- HR I/O banks 17 and 18 are not bonded out.
- All HP I/O banks are fully bonded out.
- GTX Quads 117 and 118 are not bonded out.

### FBG900, FFG900, and RF900 Packages

All HR and HP I/O banks and the GTX Quads are fully bonded out in these packages.

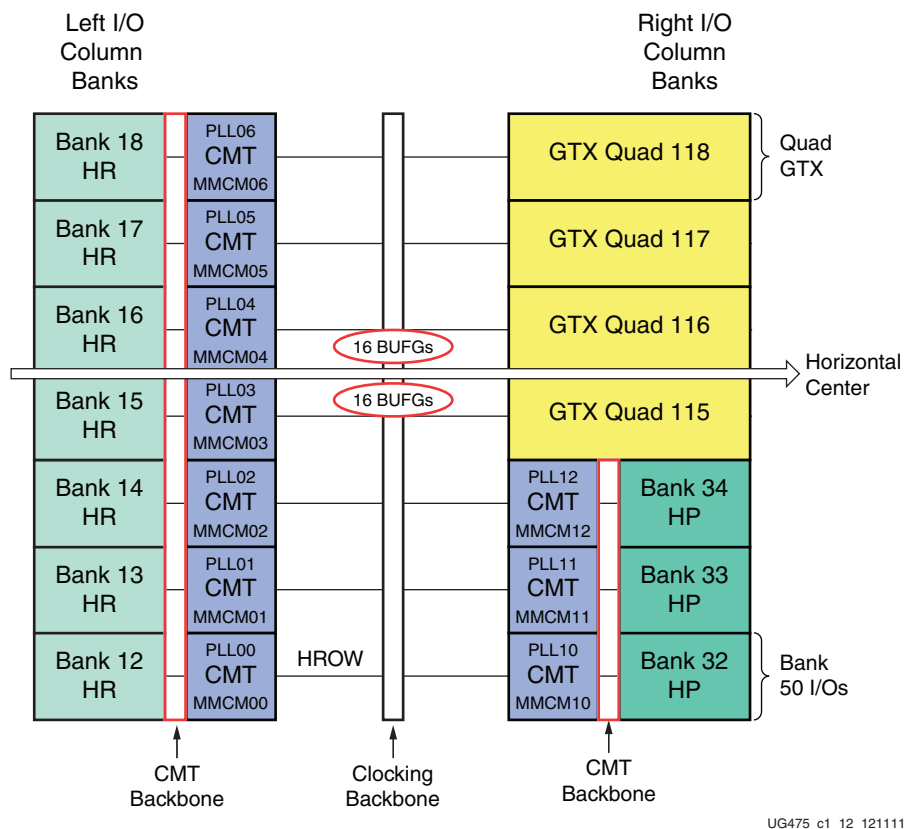

Figure 1-7: XC/XQ7K410T Banks

## XC7K420T Banks

Figure 1-8 shows the I/O and transceiver banks for the XC7K420T.

### FFG901 Package

- HR I/O bank 18 is not fully bonded out.
- GTX Quad 118 is not bonded out.

### FFG1156 Package

- All HR I/O banks and the GTX Quads are fully bonded out in this package.

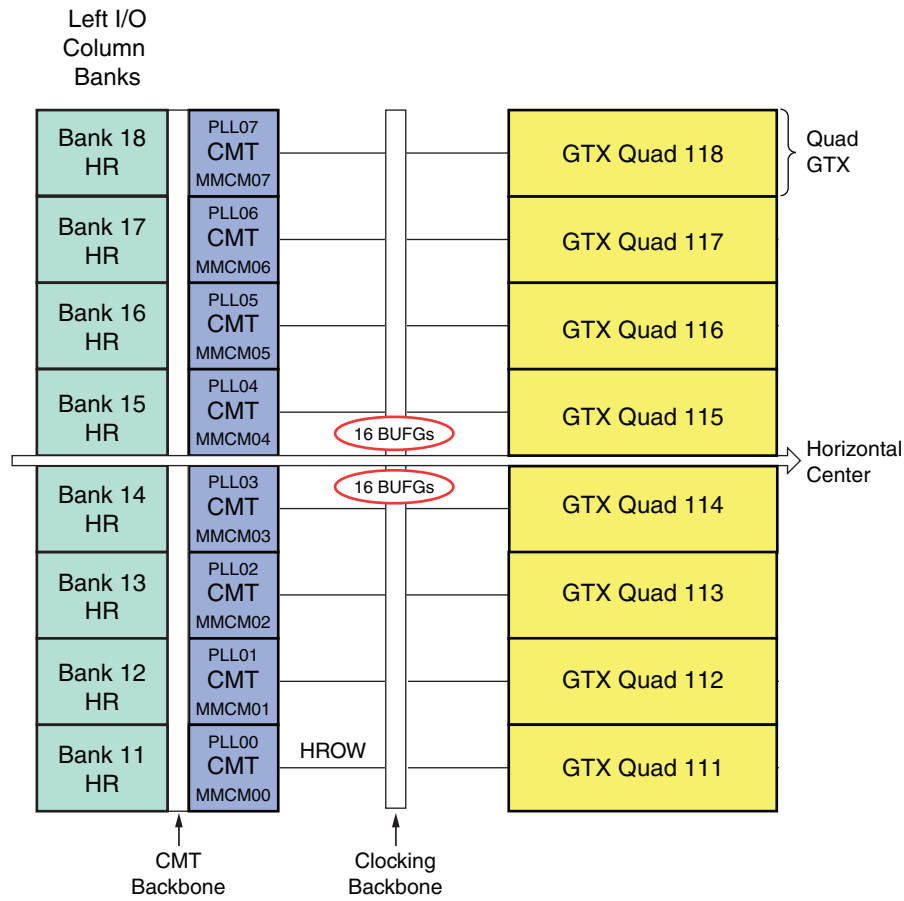

UG475\_c1\_13\_042012

Figure 1-8: XC7K420T Banks

## XC7K480T Banks

Figure 1-9 shows the I/O and transceiver banks for the XC7K480T.

### FFG901 Package

- HR I/O bank 18 is not fully bonded out.
- GTX Quad 118 is not bonded out.

### FFG1156 Package

- All HR I/O banks and the GTX Quads are fully bonded out in this package.

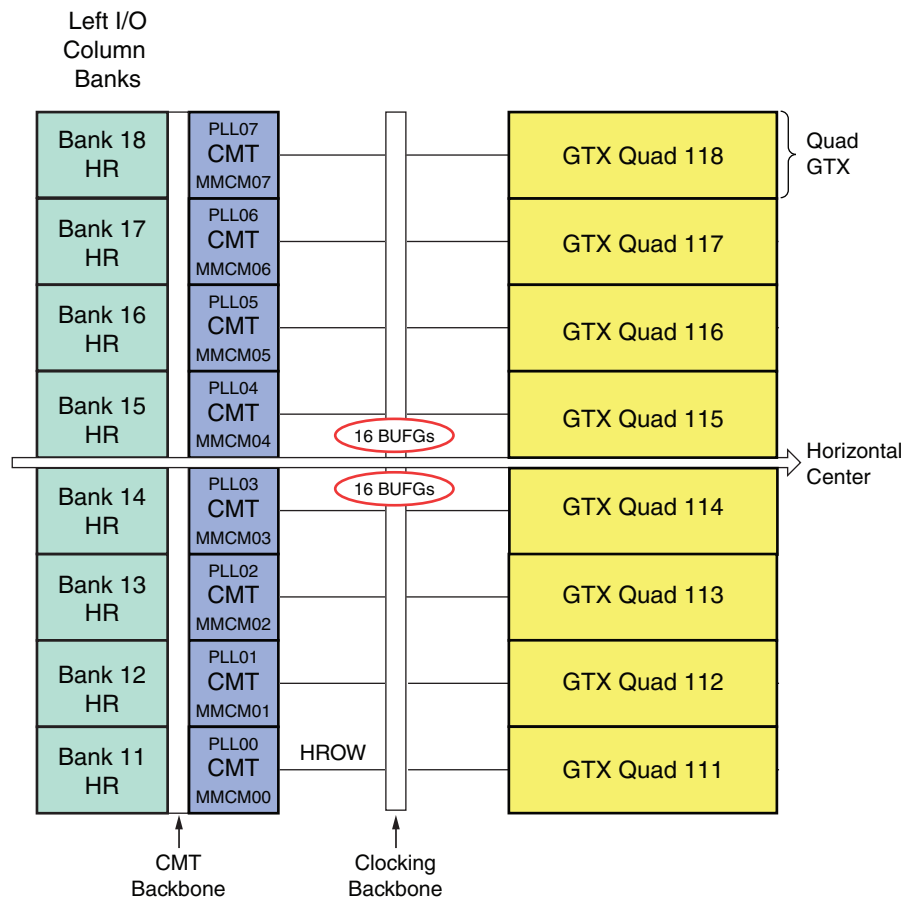

UG475\_c1\_14\_042012

Figure 1-9: XC7K480T Banks

## XC/XQ7V585T Banks

Figure 1-10 shows the I/O and transceiver banks for the XC/XQ7V585T.

### FFG1157 and RF1157 Packages

- All HR I/O banks (11, 12, and 13) are not bonded out.
- HP I/O banks 31, 32, and 33 are not bonded out.
- GTX Quads 111, 112, 113, and 119 are not bonded out.

### FFG1761 and RF1761 Packages

- HR I/O bank 11 is not bonded out.
- All HP I/O banks and the GTX Quads are fully bonded out in these packages.

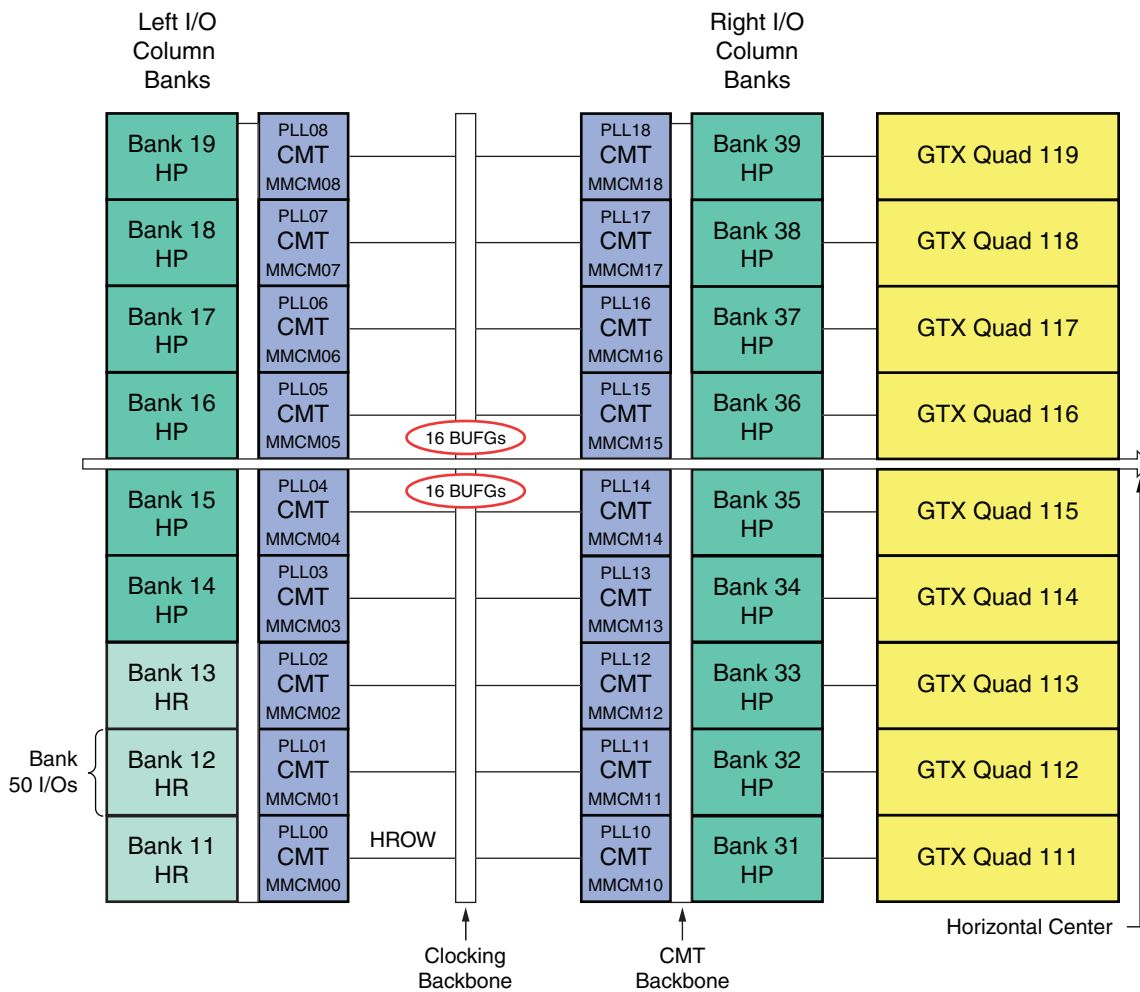

Figure 1-10: XC/XQ7V585T Banks

## XC7V2000T Banks

Figure 1-11 shows the I/O and transceiver banks for the XC7V2000T.

### FHG1761 Package

- HP I/O banks 11, 20, 21, 22, 40, 41, and 42 are not bonded out.
- GTX Quads 120, 121, and 122 are not bonded out.

### FLG1925 Package

- All HP I/O banks are fully bonded out in this package.
- GTX Quads 111, 116, 117, 118, 119, 120, 121, and 122 are not bonded out.



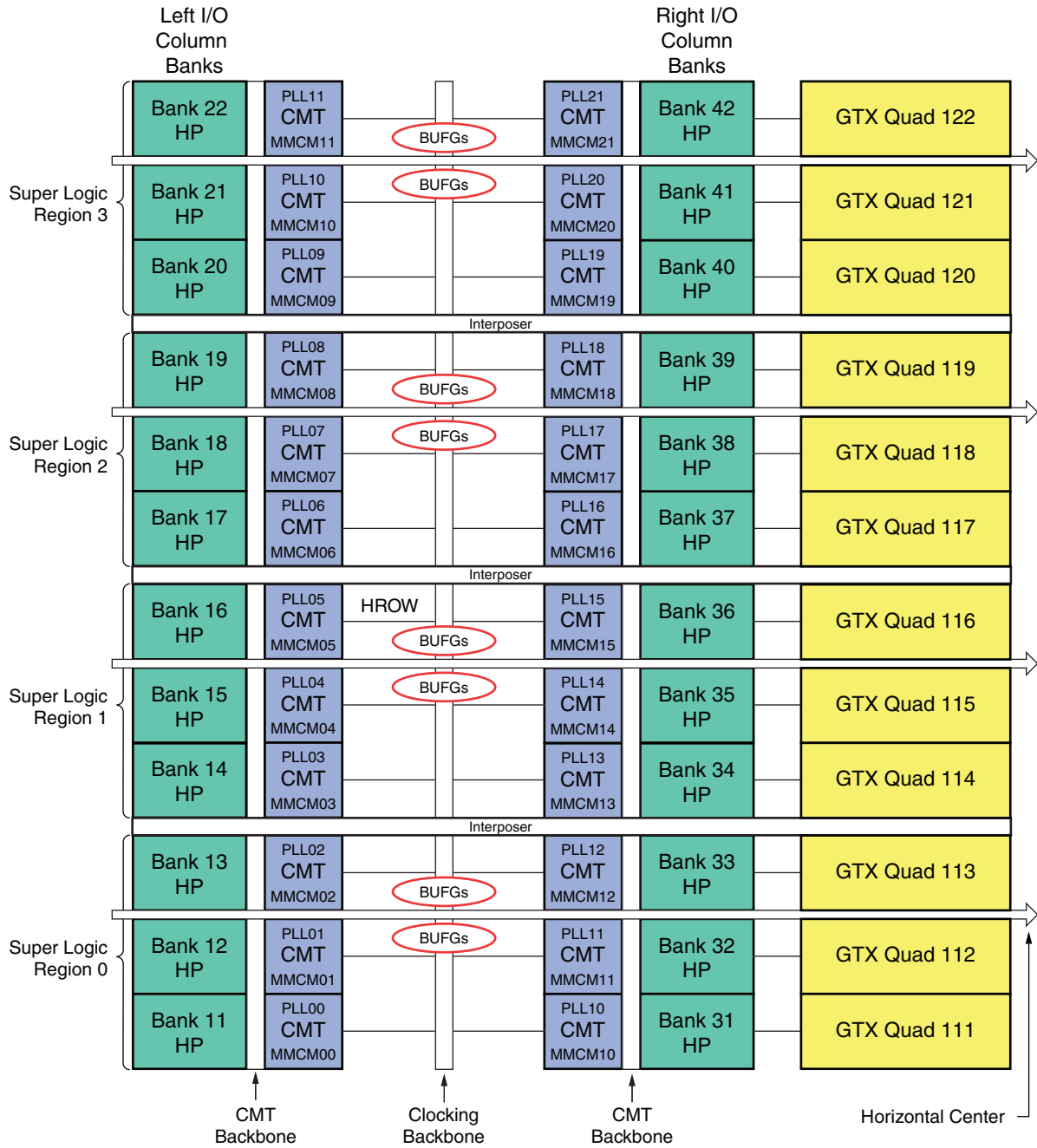

UG475\_c1\_17\_121111

Figure 1-11: XC7V2000T Banks

## XC/XQ7VX330T Banks

Figure 1-12 shows the I/O and transceiver banks for the XC/XQ7VX330T.

### FFG1157 and RF1157 Packages

- HR I/O bank 13 is not bonded out.
- HP I/O bank 33 is not bonded out.
- GTH Quads 113 and 119 are not bonded out.

### FFG1761 and RF1761 Packages

All HR and HP I/O banks and the GTH Quads are fully bonded out in these packages.

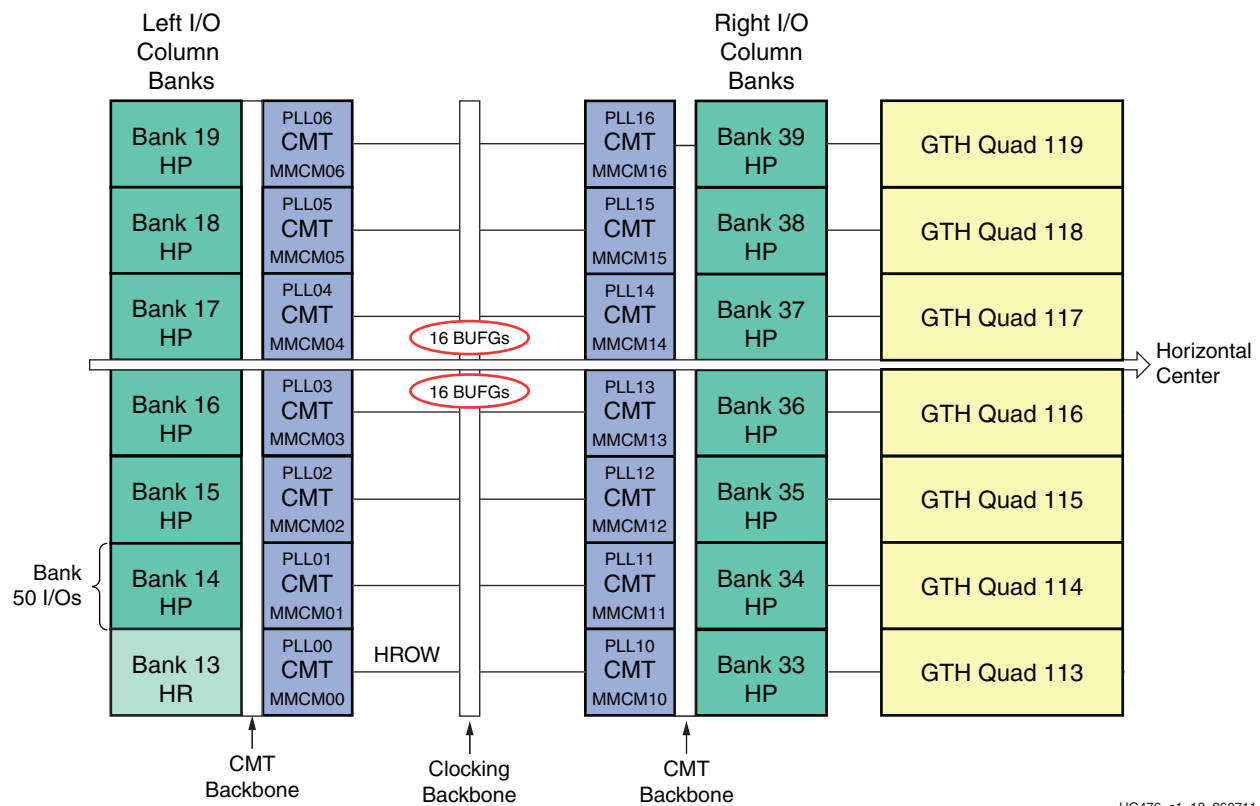

Figure 1-12: XC/XQ7VX330T Banks

UG476\_c1\_18\_060711

## XC7VX415T Banks

Figure 1-13 shows the I/O and transceiver banks for the XC7VX415T.

### FFG1157 Package

- All HP I/O banks are fully bonded out.
- GTH Quads 119, 214, 215, 216, 217, 218, and 219 are not bonded out.

### FFG1158 Package

- HP I/O banks 18, 19, 37, 38, and 39 are not bonded out.
- GTH Quads are fully bonded out in this package.

### FFG1927 Package

All HP I/O banks and the GTH Quads are fully bonded out in this package.

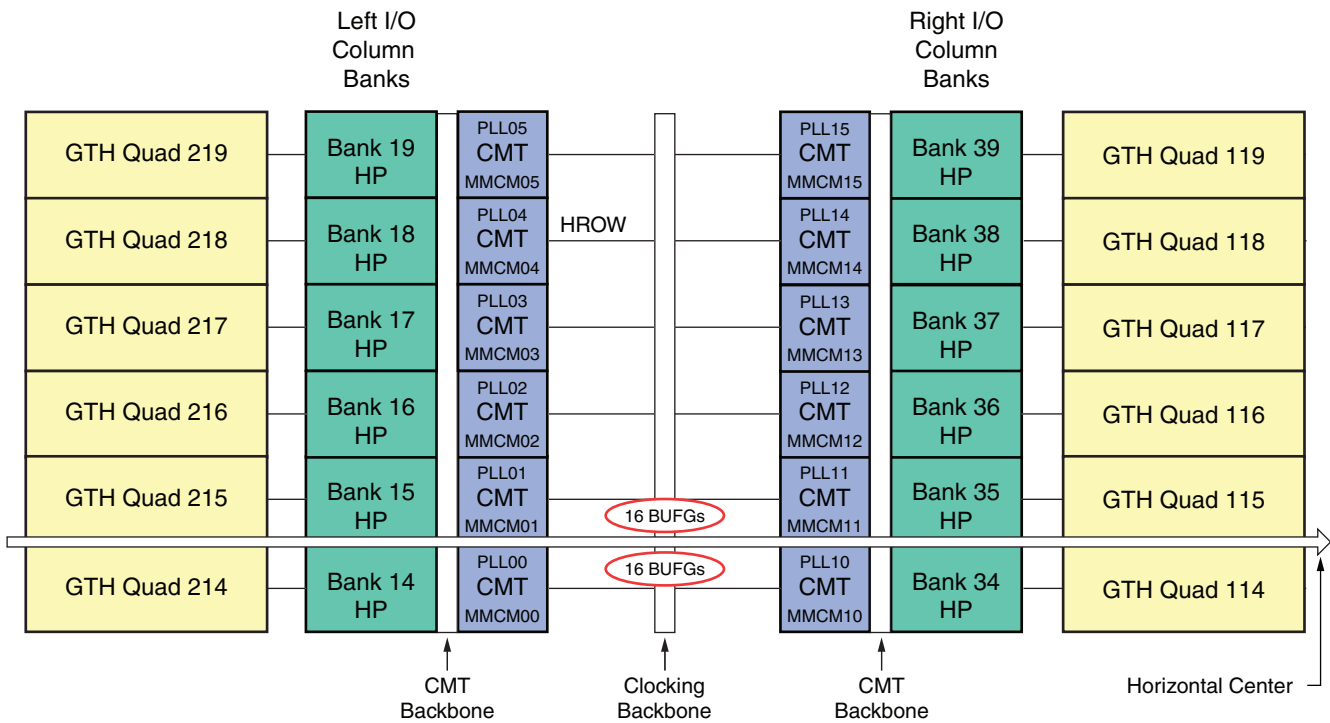

UG476\_c1\_19\_071411

Figure 1-13: XC7VX415T Banks

## XC/XQ7VX485T Banks

Figure 1-14 shows the I/O and transceiver banks for the XC/XQ7VX485T.

### FFG1157 Package

- HP I/O banks 13 and 33 are not bonded out.
- GTX Quads 113, 119, 213, 214, 215, 216, 217, 218, and 219 are not bonded out.

### FFG1158 Package

- HP I/O banks 13, 18, 19, 33, 37, 38, and 39 are not bonded out.
- GTX Quads 113 and 213 are not bonded out.

### FFG1761 and RF1761 Packages

- All HP I/O banks are fully bonded out in these packages.
- GTX Quads 213, 214, 215, 216, 217, 218, and 219 are not bonded out.

### FFG1927 Package

- HP I/O banks 13 and 33 are not bonded out.
- All the GTX Quads are fully bonded out in this package.

### FFG1930 and RF1930 Packages

- All HP I/O banks are fully bonded out in these packages.
- GTX Quads 119, 213, 214, 215, 216, 217, 218, and 219 are not bonded out.

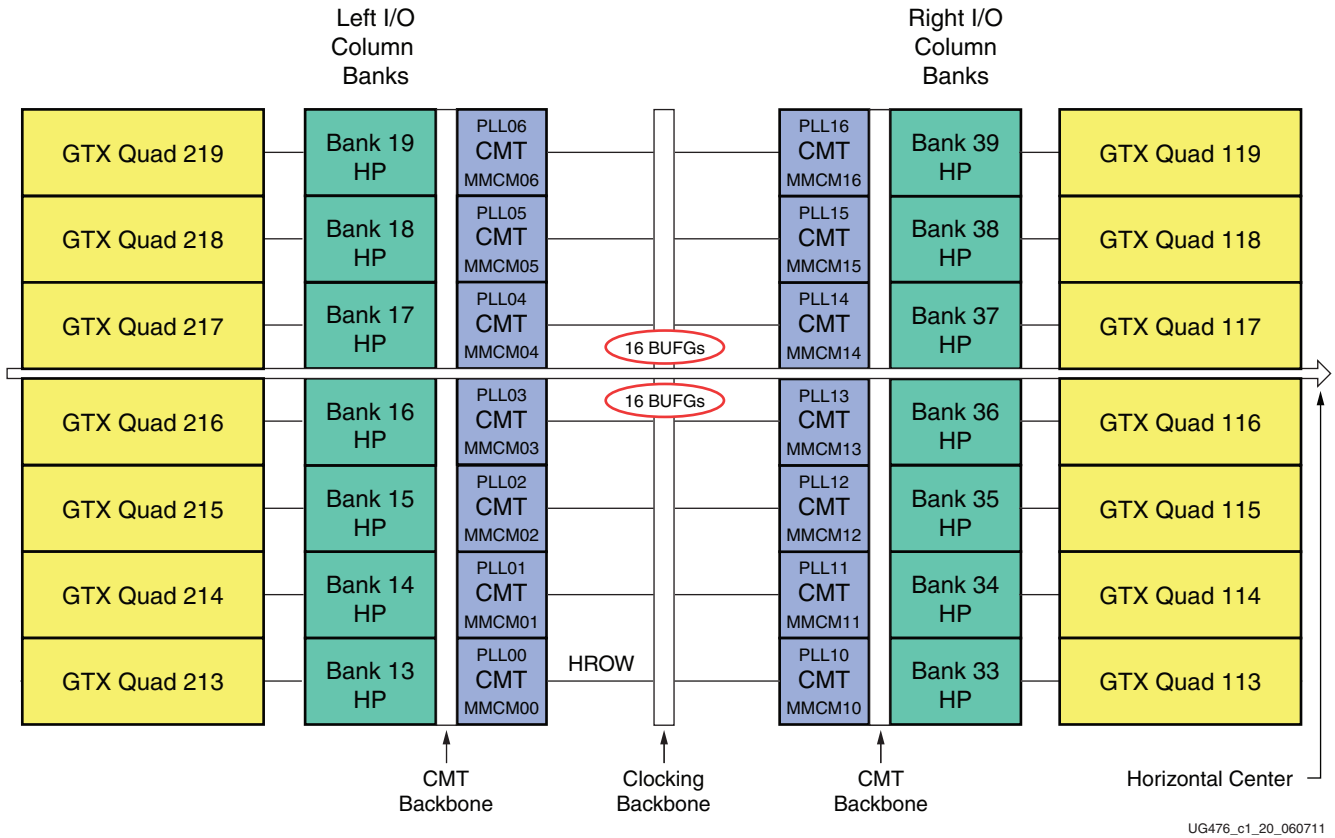

UG476\_c1\_20\_060711

Figure 1-14: XC/Q7VX485T Banks

## XC7VX550T Banks

Figure 1-15 shows the I/O and transceiver banks for the XC7VX550T.

### FFG1158 Package

- HP I/O banks 10, 11, 12, 13, 18, 19, 30, 31, 32, 33, 37, 38, and 39 are not bonded out.
- GTH Quads 110, 111, 112, 113, 210, 211, 212, and 213 are not bonded out.

### FFG1927 Package

- HP I/O banks 10, 11, 12, 13, 30, 31, 32, and 33 are not bonded out.
- All GTH Quads are fully bonded out in this package.



UG475\_c1\_21\_042012

Figure 1-15: XC7VX550T Banks

## XC/XQ7VX690T Banks

Figure 1-16 shows the I/O and transceiver banks for the XC/XQ7VX690T.

### FFG1157 and RF1157 Packages

- HP I/O banks 10, 11, 12, 13, 30, 31, 32, and 33 are not bonded out.
- GTH Quads 110, 111, 112, 113, 119, 210, 211, 212, 213, 214, 215, 216, 217, 218, and 219 are not bonded out.

### FFG1158 Package

- HP I/O banks 10, 11, 12, 13, 18, 19, 30, 31, 32, 33, 37, 38, and 39 are not bonded out.
- GTH Quads 110, 111, 112, 113, 210, 211, 212, and 213 are not bonded out.

### FFG1761 and RF1761 Packages

- HP I/O banks 10, 11, and 30 are not bonded out.
- GTH Quads 110, 210, 211, 212, 213, 214, 215, 216, 217, 218, and 219 are not bonded out.

### FFG1926 Package

- HP I/O bank 17 is partially bonded out.
- HP I/O banks 18, 19, 37, 38, and 39 are not bonded out.
- GTH Quads 110, 119, 210, and 219 are not bonded out.

### FFG1927 Package

- HP I/O banks 10, 11, 12, 13, 30, 31, 32, and 33 are not bonded out.
- All GTH Quads are fully bonded out in this package.

### FFG1930 and RF1930 Packages

- All HP I/O banks are fully bonded out in these packages.
- GTH Quads 110, 111, 112, 119, 210, 211, 212, 213, 214, 215, 216, 217, 218, and 219 are not bonded out.



UG475\_c1\_22\_081211

Figure 1-16: XC/Q7VX690T Banks



## XC/XQ7VX980T Banks

Figure 1-17 shows the I/O and transceiver banks for the XC/XQ7VX980T.

### FFG1926 Package

- HP I/O bank 17 is partially bonded out.
- HP I/O banks 18, 37, and 38 are not bonded out.
- GTH Quads 110 and 210 are not bonded out.

### FFG1928 Package

- HP I/O bank 16 is partially bonded out.
- HP I/O banks 10, 11, 12, 17, 18, 30, 31, and 32 are not bonded out.
- All GTH Quads are fully bonded out in this package.

### FFG1930 and RF1930 Packages

- All HP I/O banks are fully bonded out in these packages.
- GTH Quads 110, 111, 112, 210, 211, 212, 213, 214, 215, 216, 217, and 218 are not bonded out.

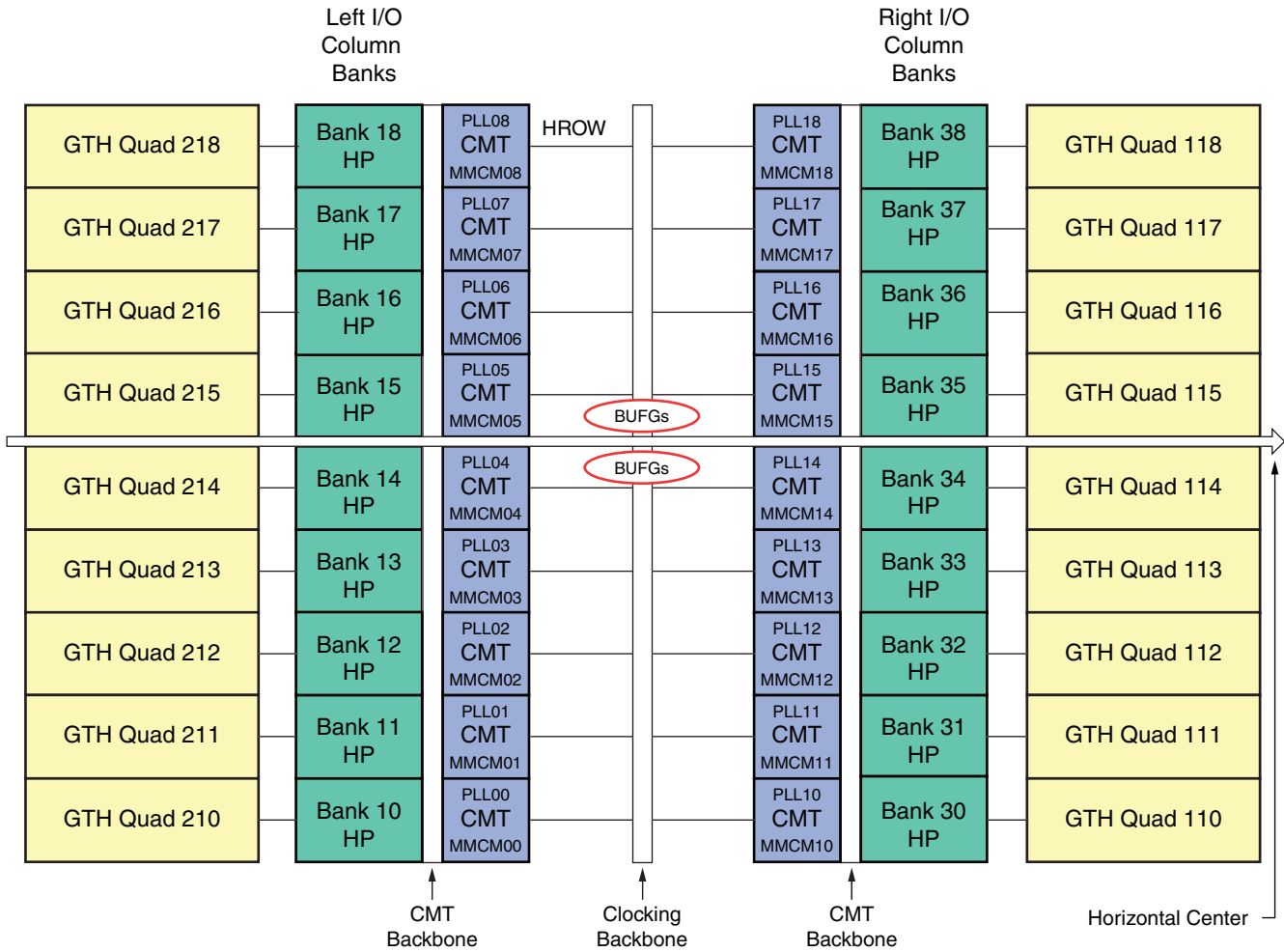

UG475\_c1\_23\_111011

Figure 1-17: XC/Q7VX980T Banks

## XC7VX1140T Banks

Figure 1-18 shows the I/O and transceiver banks for the XC7VX1140T.

### FLG1926 Package

- HP I/O bank 17 is partially bonded out.
- HP I/O banks 18, 19, 20, 21, 37, 38, 39, 40, and 41 are not bonded out.
- GTH Quads 110, 119, 120, 121, 210, 219, 220, and 221 are not bonded out.

### FLG1928 Package

- HP I/O bank 16 is partially bonded out.
- HP I/O banks 10, 11, 12, 17, 18, 19, 20, 21, 30, 31, 32, 39, 40, and 41 are not bonded out.
- All GTH Quads are fully bonded out in this package.

### FLG1930 Package

- HP I/O banks 40 and 41 are not bonded out.
- GTH Quads 110, 111, 112, 119, 120, 121, 210, 211, 212, 213, 214, 215, 216, 217, 218, 219, 220, and 221 are not bonded out.

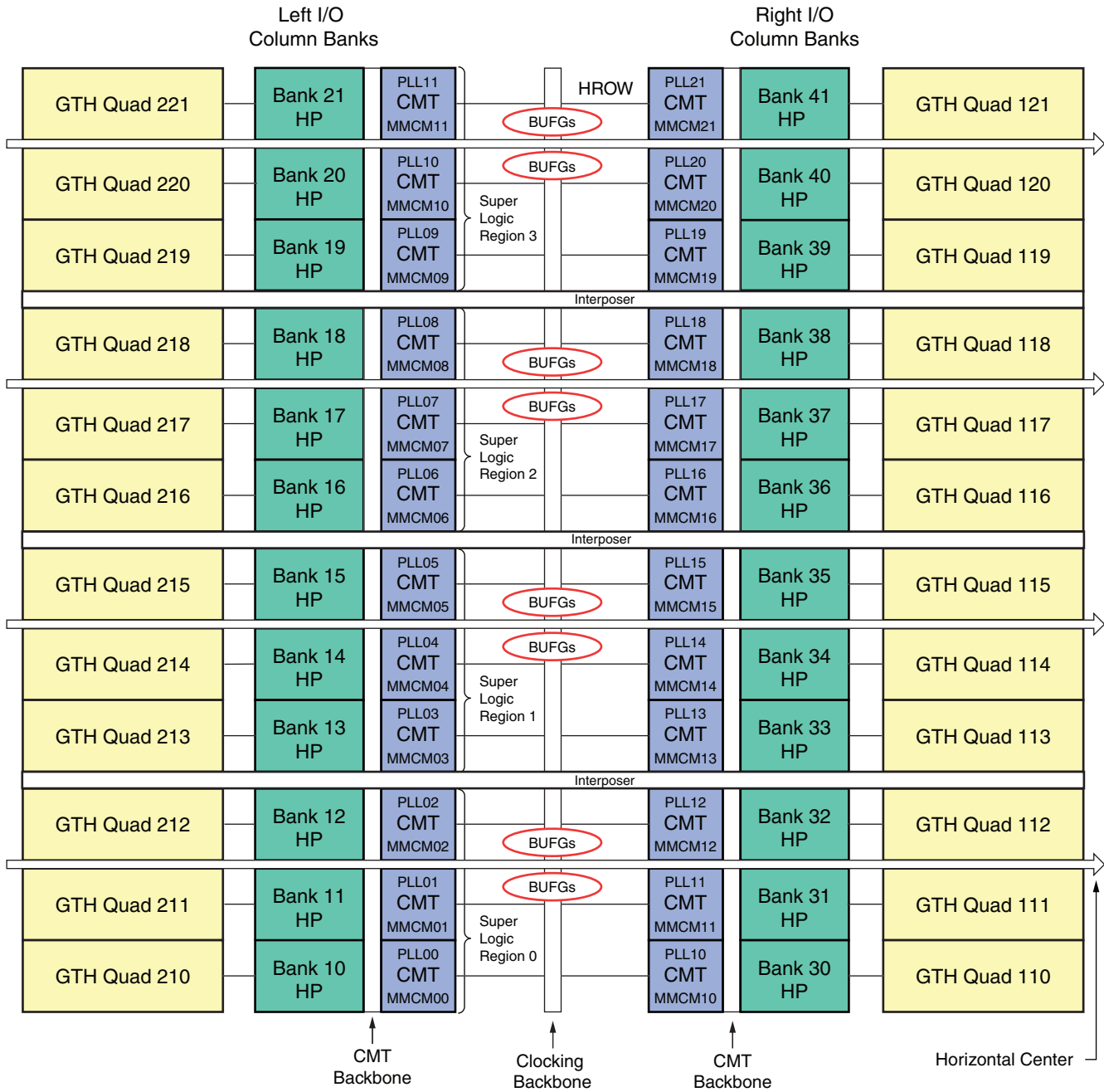

UG475\_c1\_24\_121111

Figure 1-18: XC7VX1140T Banks

# 7 Series FPGAs Package Files

---

## About ASCII Package Files

The ASCII files for each package include a comma-separated-values (CSV) version and a text version optimized for a browser or text editor. Each of the files consists of the following:

- Device/Package name (*FPGA Family—Device—Package*), date and time of creation
- Eight columns containing data for each pin:
  - Pin—Pin location on the package.
  - Pin Name—The name of the assigned pin.
  - Memory Byte Group—Memory byte group between 0 and 3. For more information on the memory byte group, see [UG586](#), *7 Series FPGAs Memory Interface Solutions User Guide*.
  - Bank—Bank number.
  - V<sub>CCAUX</sub> Group—Number corresponding to the V<sub>CCAUX\_IO</sub> power supply for the given pin. V<sub>CCAUX</sub> is shown for packages with only one V<sub>CCAUX</sub> group.
  - Super Logic Region—Number corresponding to the super logic region (SLR) in the devices implemented with stacked silicon interconnect (SSI) technology.
  - I/O Type—CONFIG, HR, HP, or GT (GTP, GTX, GTH) depending on the I/O type. For more information on the I/O type, see [UG471](#), *7 Series FPGAs SelectIO Resources User Guide*.
  - No-Connect—This list of devices is used for migration between devices that have the same package size and are not connected at that specific pin.
- Total number of pins in the package.

## ASCII Pinout Files

This chapter includes the pinout information tables for the following device/packages.

**Note:** All package files are ASCII files in TXT and CSV file format.

To download all available Artix-7 FPGAs package/device/pinout files click here:

<http://www.xilinx.com/support/packagefiles/artix-7-pkgs.htm>

**Note:** Only the available files listed in [Table 2-1](#) are linked and consolidated in the above ZIP file.

Table 2-1: Artix-7 FPGAs Package/Device Pinout Files

Device	CSG324	FTG256	SBG484	FG(G)484	FGG676	FBG484	FBG676	FFG1156	RB484	RS484	RB676
XC7A100T	<a href="#">CSG324</a>	<a href="#">FTG256</a>		<a href="#">FGG484</a>	<a href="#">FGG676</a>						
XC7A200T			<a href="#">SBG484</a>			<a href="#">FBG484</a>	<a href="#">FBG676</a>	<a href="#">FFG1156</a>			
XQ7A100T	<a href="#">CG324</a>			<a href="#">FG484</a>							
XQ7A200T									RB484	RS484	RB676

To download all available Kintex-7 FPGAs package/device/pinout files click here:

<http://www.xilinx.com/support/packagefiles/kintex-7-pkgs.htm>

**Note:** Only the available files listed in [Table 2-2](#) are linked and consolidated in the above ZIP file.

Table 2-2: Kintex-7 FPGAs Package/Device Pinout Files

Device	FB484/ FBG484	FB676/ FBG676	FB900/ FBG900	FF676/ FFG676	FF900/ FFG900	FF901/ FFG901	FF1156/ FFG1156	RF676	RF900
XC7K70T	<a href="#">FBG484</a>	<a href="#">FBG676</a>							
XC7K160T	<a href="#">FB484/ FBG484</a>	<a href="#">FB676/ FBG676</a>		<a href="#">FF676/ FFG676</a>					
XC7K325T		<a href="#">FB676/ FBG676</a>	<a href="#">FB900/ FBG900</a>	<a href="#">FF676/ FFG676</a>	<a href="#">FF900/ FFG900</a>				
XC7K355T						<a href="#">FF901/ FFG901</a>			
XC7K410T		<a href="#">FB676/ FBG676</a>	<a href="#">FB900/ FBG900</a>	<a href="#">FF676/ FFG676</a>	<a href="#">FF900/ FFG900</a>				
XC7K420T						<a href="#">FF901/ FFG901</a>	<a href="#">FF1156/ FFG1156</a>		
XC7K480T						<a href="#">FF901/ FFG901</a>	<a href="#">FF1156/ FFG1156</a>		
XQ7K325T								RF676	RF900
XQ7K410T								RF676	RF900

To download all available Virtex-7 FPGAs package/device/pinout files click here:

<http://www.xilinx.com/support/packagefiles/virtex-7-pkgs.htm>

**Note:** Only the available files listed in Table 2-3 and Table 2-4 are linked and consolidated in the above ZIP file.

Table 2-3: Virtex-7 T FPGAs Package/Device Pinout Files

Device	FF1157/FFG1157	FF1761/FFG1761	FL1925/FLG1925	FH1761/FHG1761	RF1157	RF1761
XC7V585T	<a href="#">FF1157/FFG1157</a>	<a href="#">FF1761/FFG1761</a>				
XC7V2000T			<a href="#">FL1925/FLG1925</a>	<a href="#">FH1761/FHG1761</a>		
XQ7V585T					RF1157	RF1761

Table 2-4: Virtex-7 XT FPGAs Package/Device Pinout Files

Device	FF1157 FFG1157 RF1157	FF1158 FFG1158	FF1761 FFG1761 RF1761	FF1926 FFG1926	FF1927 FFG1927	FF1928 FFG1928	FF1930 FFG1930 RF1930	FL1926 FLG1926	FL1928 FLG1928	FL1930 FLG1930
XC7VX330T	<a href="#">FF1157/ FFG1157</a>		<a href="#">FF1761/ FFG1761</a>							
XC7VX415T	<a href="#">FF1157/ FFG1157</a>	<a href="#">FF1158/ FFG1158</a>			<a href="#">FF1927/ FFG1927</a>					
XC7VX485T	<a href="#">FF1157/ FFG1157</a>	<a href="#">FF1158/ FFG1158</a>	<a href="#">FF1761/ FFG1761</a>		<a href="#">FF1927/ FFG1927</a>		<a href="#">FF1930/ FFG1930</a>			
XC7VX550T		<a href="#">FF1158/ FFG1158</a>			<a href="#">FF1927/ FFG1927</a>					
XC7VX690T	<a href="#">FF1157/ FFG1157</a>	<a href="#">FF1158/ FFG1158</a>	<a href="#">FF1761/ FFG1761</a>	<a href="#">FF1926/ FFG1926</a>	<a href="#">FF1927/ FFG1927</a>		<a href="#">FF1930/ FFG1930</a>			
XC7VX980T				<a href="#">FF1926/ FFG1926</a>		<a href="#">FF1928/ FFG1928</a>	<a href="#">FF1930/ FFG1930</a>			
XC7VX1140T								<a href="#">FL1926/ FLG1926</a>	<a href="#">FL1928/ FLG1928</a>	<a href="#">FL1930/ FLG1930</a>
XQ7VX330T	RF1157		RF1761							
XQ7VX485T			RF1761				RF1930			
XQ7VX690T	RF1157		RF1761				RF1930			
XQ7VX980T							RF1930			





# Device Diagrams

---

## Summary

This chapter provides pinout, high-performance and high-range I/O bank, memory groupings, and power and ground placement diagrams for each 7 series FPGA package/device combination.

- [Artix-7 FPGAs Device Diagrams, page 58](#)
- [Kintex-7 FPGAs Device Diagrams, page 82](#)
- [Virtex-7 FPGAs Device Diagrams, page 114](#)

The figures provide a top-view perspective.

The symbols for the multi-function I/O pins are represented by only one of the available pin functions; with precedence (by functionality) in this order:

- ADV\_B, FCS\_B, FOE\_B, MOSI, FWE\_B, DOUT\_CSO\_B, CSI\_B, PUDC\_B, or RDWR\_B
- RS0–RS1
- AD0P/AD0N–AD15P/AD15N
- EMCCLK
- VRN, VRP, or VREF
- D00–D31
- A00–A28
- DQS, MRCC, or SRCC

For example, a pin description such as IO\_L8P\_SRCC\_12 is represented with a SRCC symbol, a pin description such as IO\_L19N\_T3\_A09\_D25\_VREF\_14 is represented with a VREF symbol, and a pin description such as IO\_L21N\_T3\_DQS\_A06\_D22\_14 is represented with a D0–D31 symbol.

**Note:** For brevity, the device prefixes for Xilinx commercial (XC), defense-grade (XQ), and automotive (XA) are missing.

# Artix-7 FPGAs Device Diagrams

Table 3-1: Artix-7 FPGAs Device Diagrams Cross-Reference

Device	CS/CSG324	FTG256	SBG484 RS484	FG/FGG484	FGG676	FBG484 RB484	FBG676 RB676	FFG1156
7A100T	page 58	page 61		page 63	page 66			
7A200T			page 69			page 72	page 75	page 78

## CS/CSG324 Packages—7A100T

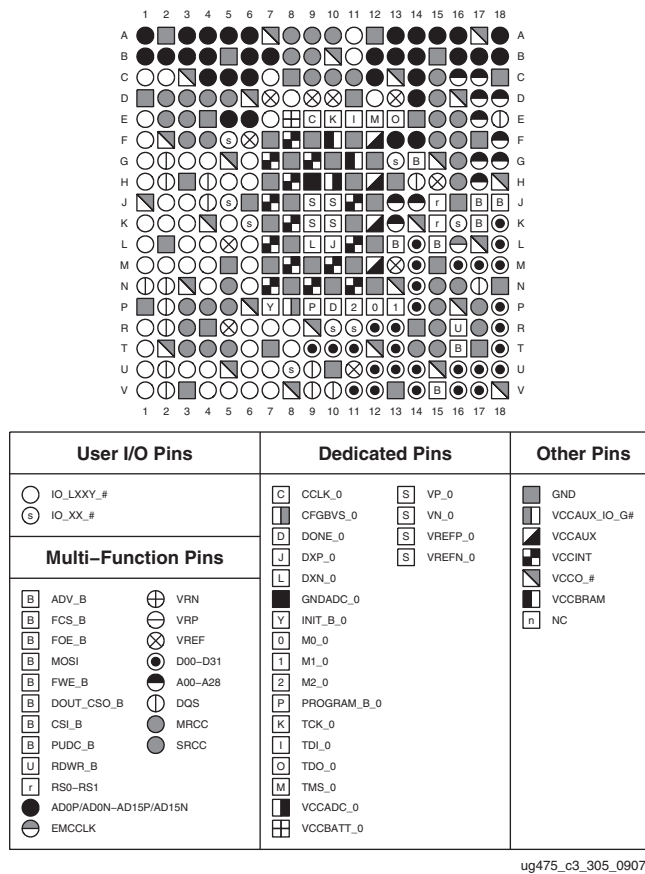

Figure 3-1: CS/CSG324 Packages—7A100T Pinout Diagram

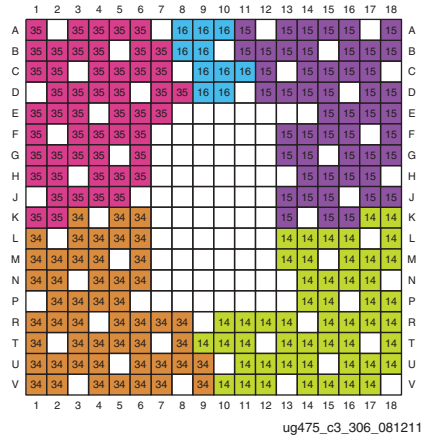

Figure 3-2: CS/CSG324 Packages—7A100T I/O Banks

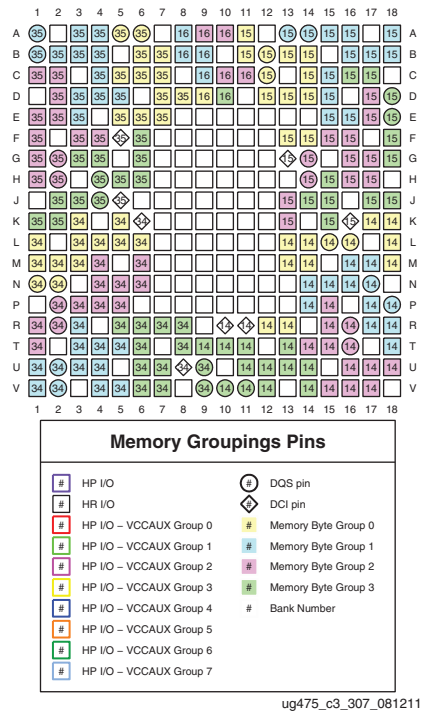
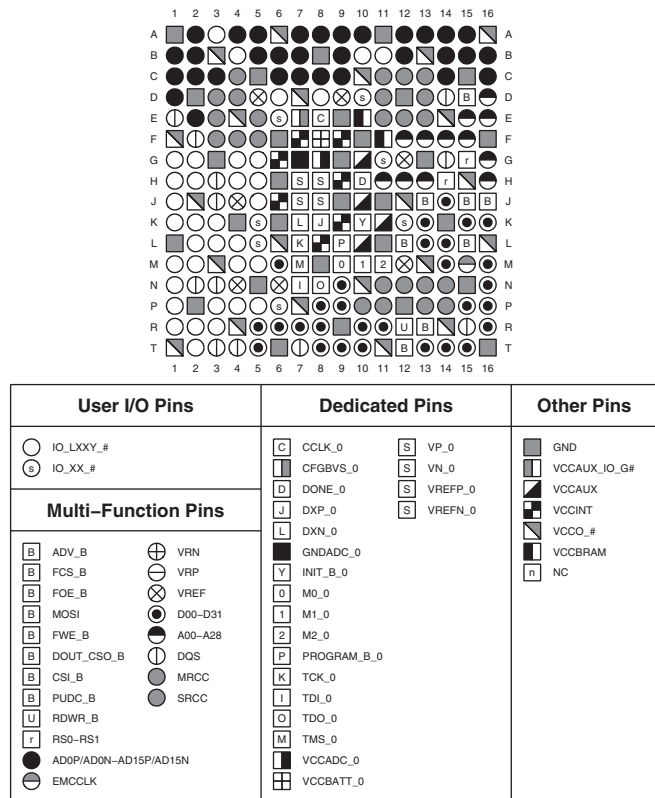

Figure 3-3: CS/CSG324 Packages—7A100T Memory Groupings



### FTG256 Package—7A100T



ug475\_c3\_317\_122711

Figure 3-5: FTG256 Package—7A100T Pinout Diagram

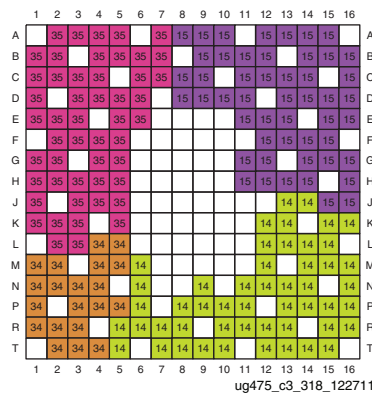

ug475\_c3\_318\_122711

Figure 3-6: FTG256 Package—7A100T I/O Banks

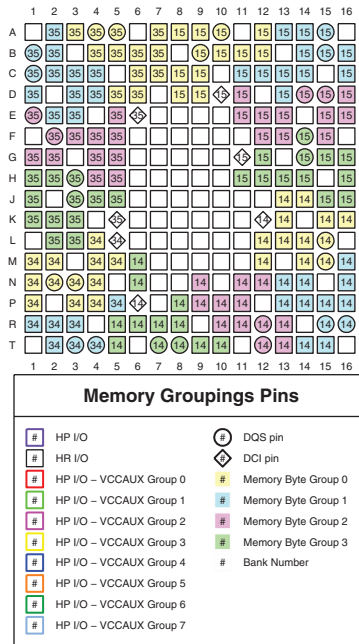

ug475\_c3\_319\_122711

Figure 3-7: FTG256 Package—7A100T Memory Groupings

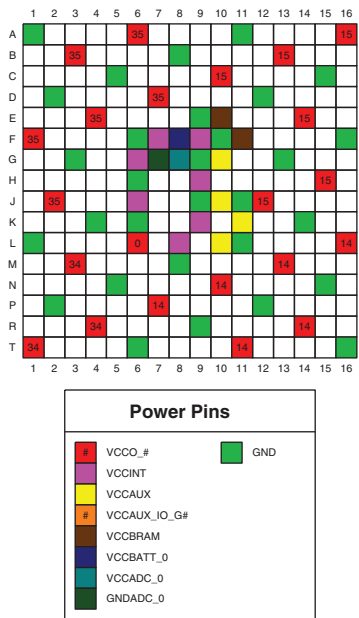

ug475\_c3\_320\_122711

Figure 3-8: FTG256 Package—7A100T Power and GND Placement

### FG/FGG484 Packages—7A100T

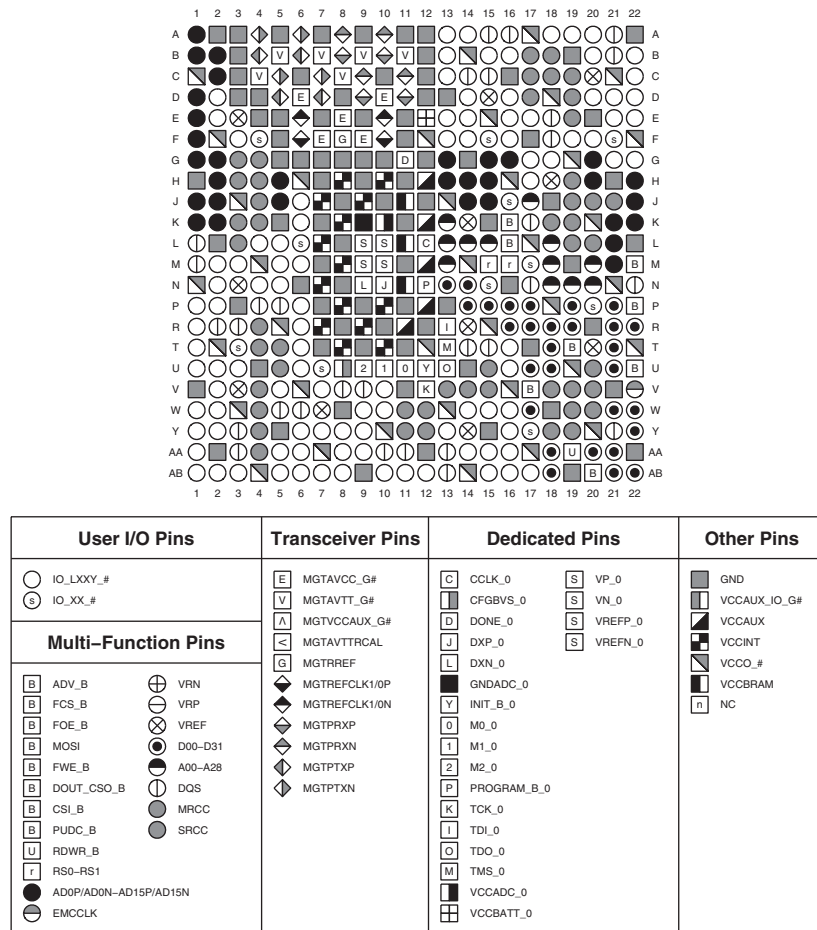

ug475\_c3\_325\_122811

Figure 3-9: FG/FGG484 Packages—7A100T Pinout Diagram

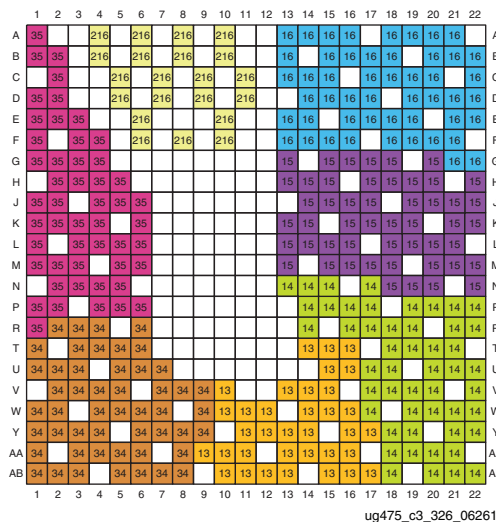

ug475\_c3\_326\_062612

Figure 3-10: FG/FGG484 Packages—7A100T I/O Banks

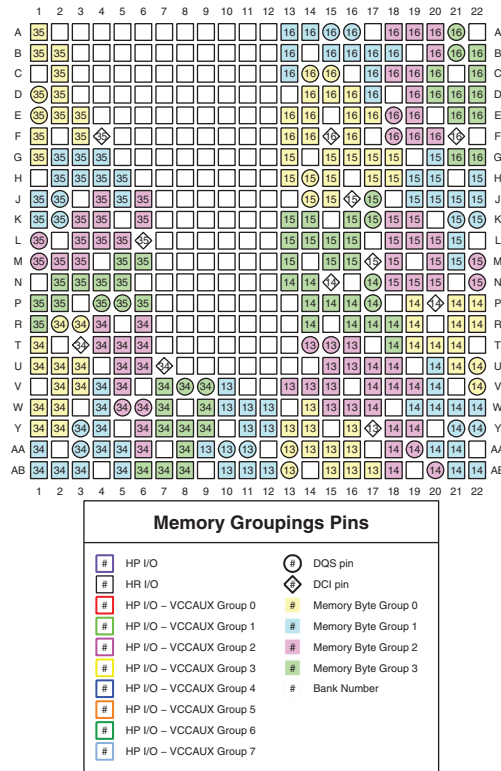

ug475\_c3\_327\_122811

Figure 3-11: FG/FGG484 Packages—7A100T Memory Groupings



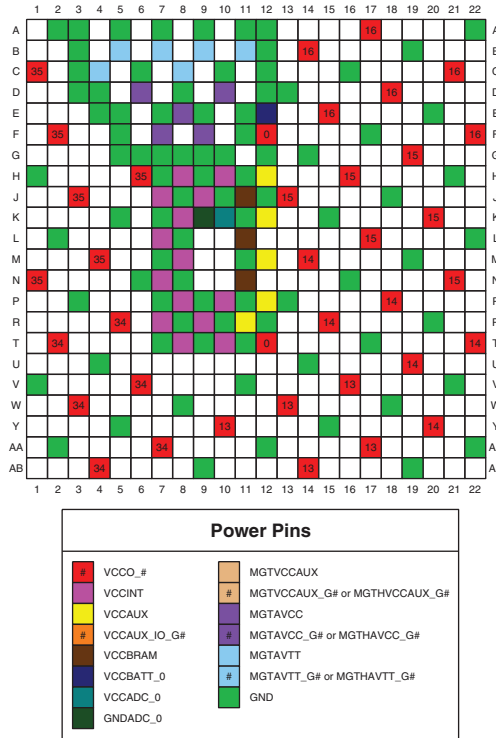

ug475\_c3\_328\_122811

Figure 3-12: FG/FGG484 Packages—7A100T Power and GND Placement

## FGG676 Package—7A100T

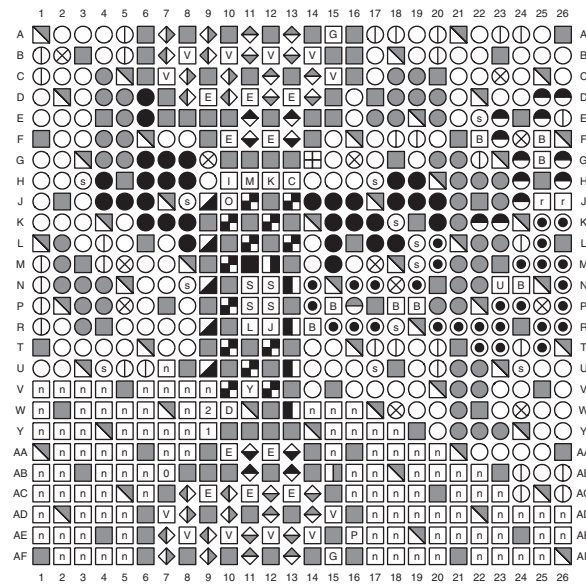

User I/O Pins	Transceiver Pins	Dedicated Pins	Other Pins
<ul style="list-style-type: none"> <li>○ IO_LXXY_#</li> <li>⊙ IO_XX_#</li> </ul>	<ul style="list-style-type: none"> <li>⊞ MGTAVCC_G#</li> <li>⊞ MGTAVTT_G#</li> <li>⊞ MGTVCCAUX_G#</li> <li>⊞ MGTAVTTRCAL</li> <li>⊞ MGTTRREF</li> <li>⊞ MGTREFCLK1/0P</li> <li>⊞ MGTREFCLK1/0N</li> <li>⊞ MGTTPRXP</li> <li>⊞ MGTTPRXN</li> <li>⊞ MGTTPTXP</li> <li>⊞ MGTTPTXN</li> </ul>	<ul style="list-style-type: none"> <li>⊞ CCLK_0</li> <li>⊞ CFGBVS_0</li> <li>⊞ DONE_0</li> <li>⊞ DXP_0</li> <li>⊞ DXN_0</li> <li>⊞ GNDADC_0</li> <li>⊞ INIT_B_0</li> <li>⊞ M0_0</li> <li>⊞ M1_0</li> <li>⊞ M2_0</li> <li>⊞ PROGRAM_B_0</li> <li>⊞ TCK_0</li> <li>⊞ TDI_0</li> <li>⊞ TDO_0</li> <li>⊞ TMS_0</li> <li>⊞ VCCADC_0</li> <li>⊞ VCCBATT_0</li> </ul>	<ul style="list-style-type: none"> <li>⊞ GND</li> <li>⊞ VCCAUX_IO_G#</li> <li>⊞ VCCAUX</li> <li>⊞ VCCINT</li> <li>⊞ VCCO_#</li> <li>⊞ VCCBRAM</li> <li>⊞ NC</li> </ul>
<b>Multi-Function Pins</b>			
<ul style="list-style-type: none"> <li>⊞ ADV_B</li> <li>⊞ FCS_B</li> <li>⊞ FOE_B</li> <li>⊞ MOSI</li> <li>⊞ FWE_B</li> <li>⊞ DOUT_CSO_B</li> <li>⊞ CSI_B</li> <li>⊞ PUDC_B</li> <li>⊞ RDWR_B</li> <li>⊞ RS0-RS1</li> <li>⊞ AD0P/AD0N--AD15P/AD15N</li> <li>⊞ EMCCLK</li> </ul>	<ul style="list-style-type: none"> <li>⊞ VRN</li> <li>⊞ VRP</li> <li>⊞ VREF</li> <li>⊞ D00-D31</li> <li>⊞ A00-A28</li> <li>⊞ DQS</li> <li>⊞ MRCC</li> <li>⊞ SRCC</li> </ul>		

ug475\_c3\_329\_070512

Figure 3-13: FGG676 Package—7A100T Pinout Diagram

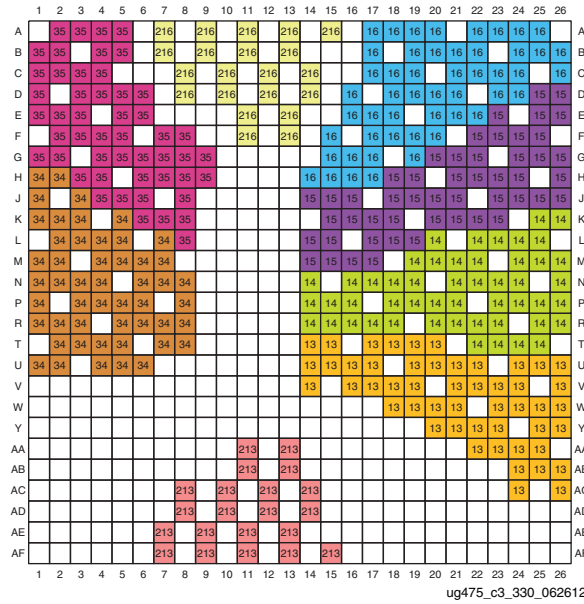

Figure 3-14: FGG676 Package—7A100T I/O Banks

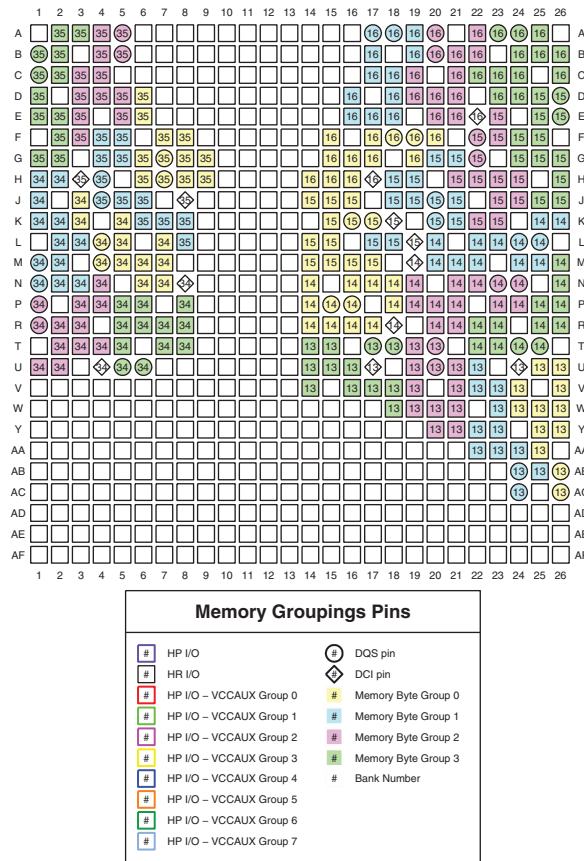
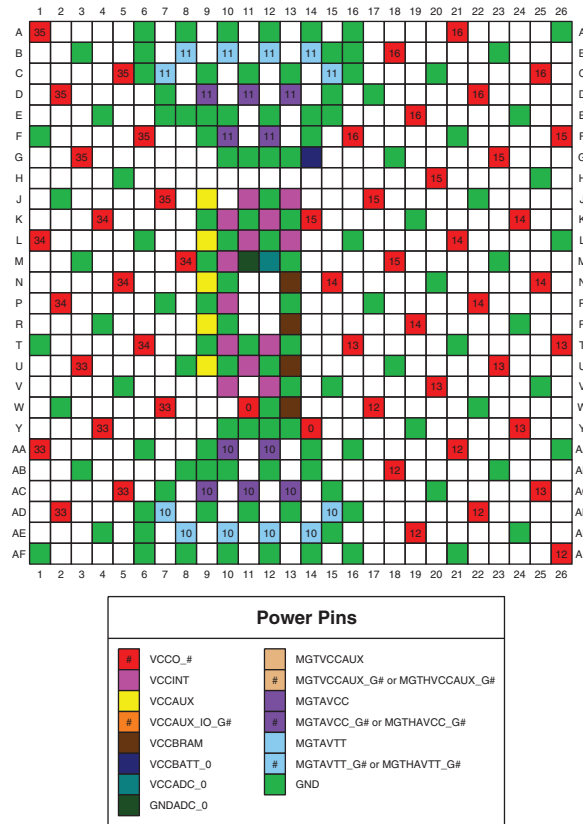

Figure 3-15: FGG676 Package—7A100T Memory Groupings



ug475\_c3\_332\_070512

Figure 3-16: FGG676 Package—7A100T Power and GND Placement

### SBG484/RB484 Packages—7A200T

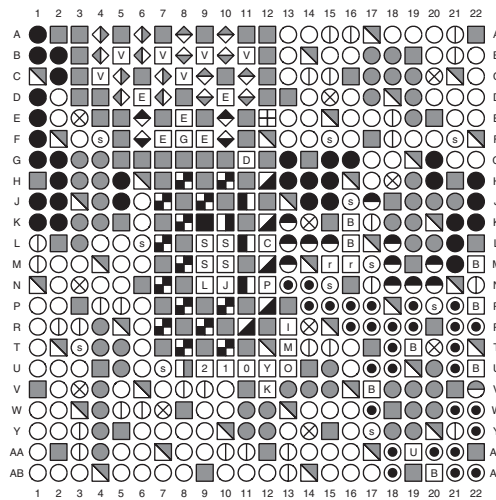

User I/O Pins	Transceiver Pins	Dedicated Pins	Other Pins
<ul style="list-style-type: none"> <li>○ IO_LXXY_#</li> <li>⊙ IO_XX_#</li> </ul>	<ul style="list-style-type: none"> <li>E MGTAVCC_G#</li> <li>V MGTAVTT_G#</li> <li>A MGTAVCCAUX_G#</li> <li>&lt; MGTAVTTRCAL</li> <li>G MGTREFREF</li> <li>◇ MGTREFCLK1/0P</li> <li>◇ MGTREFCLK1/0N</li> <li>◇ MGTTPRXP</li> <li>◇ MGTTPRXN</li> <li>◇ MGTTPTXP</li> <li>◇ MGTTPTXN</li> </ul>	<ul style="list-style-type: none"> <li>C CCLK_0</li> <li>CF CFBVS_0</li> <li>B DONE_0</li> <li>J DXP_0</li> <li>L DXN_0</li> <li>Y GNDADC_0</li> <li>0 M0_0</li> <li>1 M1_0</li> <li>2 M2_0</li> <li>P PROGRAM_B_0</li> <li>K TCK_0</li> <li>I TDI_0</li> <li>O TDO_0</li> <li>M TMS_0</li> <li>VCCADC_0</li> <li>VCCBATT_0</li> <li>S VP_0</li> <li>S VN_0</li> <li>S VREFP_0</li> <li>S VREFN_0</li> </ul>	<ul style="list-style-type: none"> <li>■ GND</li> <li>■ VCCAUX_IO_G#</li> <li>■ VCCAUX</li> <li>■ VCCINT</li> <li>■ VCCO_#</li> <li>■ VCCBRAM</li> <li>n NC</li> </ul>
<p><b>Multi-Function Pins</b></p> <ul style="list-style-type: none"> <li style="width: 50%;">B ADV_B</li> <li style="width: 50%;">⊕ VRN</li> <li style="width: 50%;">B FCS_B</li> <li style="width: 50%;">⊖ VRP</li> <li style="width: 50%;">B FOE_B</li> <li style="width: 50%;">⊗ VREF</li> <li style="width: 50%;">B MOSI</li> <li style="width: 50%;">● D00-D31</li> <li style="width: 50%;">B FWE_B</li> <li style="width: 50%;">● A00-A28</li> <li style="width: 50%;">B DOUT_CSO_B</li> <li style="width: 50%;">⊙ DQS</li> <li style="width: 50%;">B CSI_B</li> <li style="width: 50%;">● MRCC</li> <li style="width: 50%;">B PUDC_B</li> <li style="width: 50%;">● SRCC</li> <li style="width: 50%;">U RDWR_B</li> <li style="width: 50%;">R R50-RS1</li> <li style="width: 50%;">● AD0P/AD0N-AD15P/AD15N</li> <li style="width: 50%;">⊖ EMCCLK</li> </ul>			

ug475\_c3\_309\_070612

Figure 3-17: SBG484/RB484 Packages—7A200T Pinout Diagram

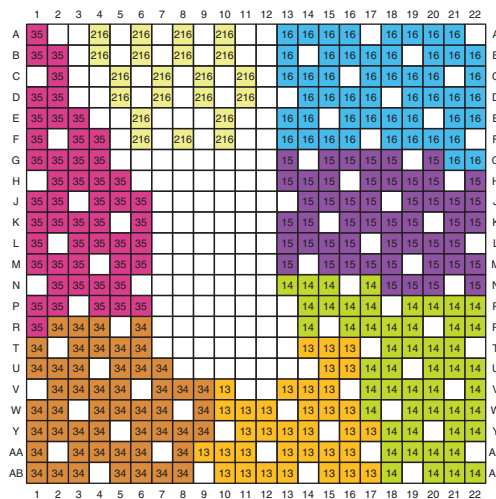

ug475\_c3\_310\_070612

Figure 3-18: SBG484/RB484 Packages—7A200T I/O Banks

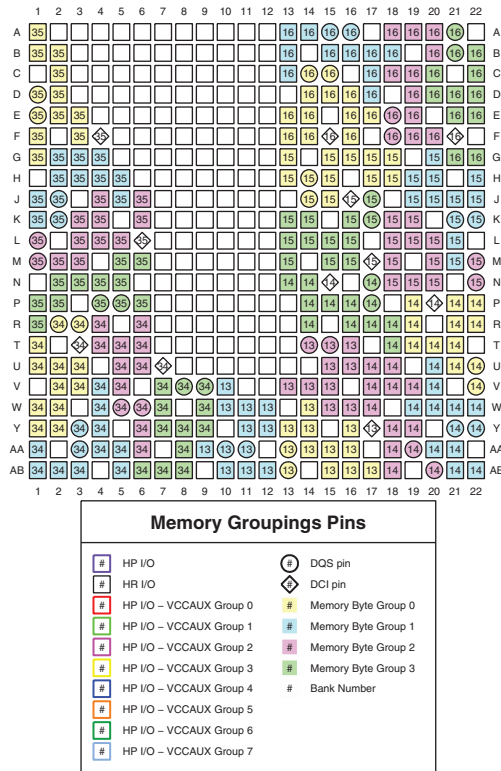

ug475\_c3\_311\_070612

Figure 3-19: SBG484/RB484 Packages—7A200T Memory Groupings

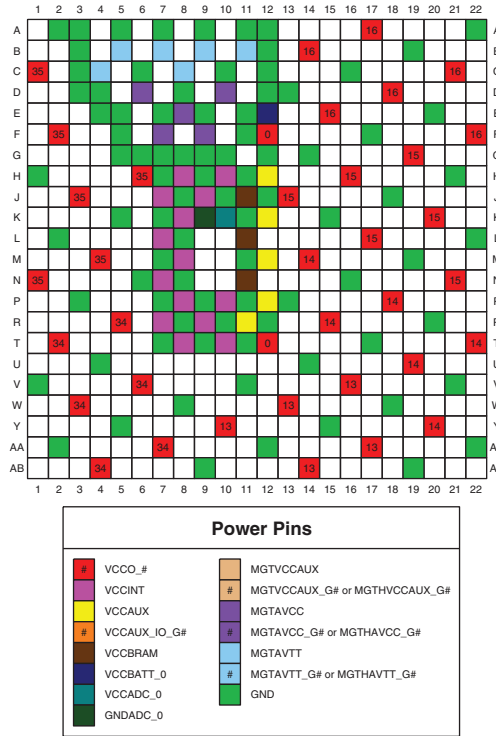

ug475\_c3\_312\_070612

Figure 3-20: SBG484/RB484 Packages—7A200T Power and GND Placement

## FBG484/RB484 Packages—7A200T

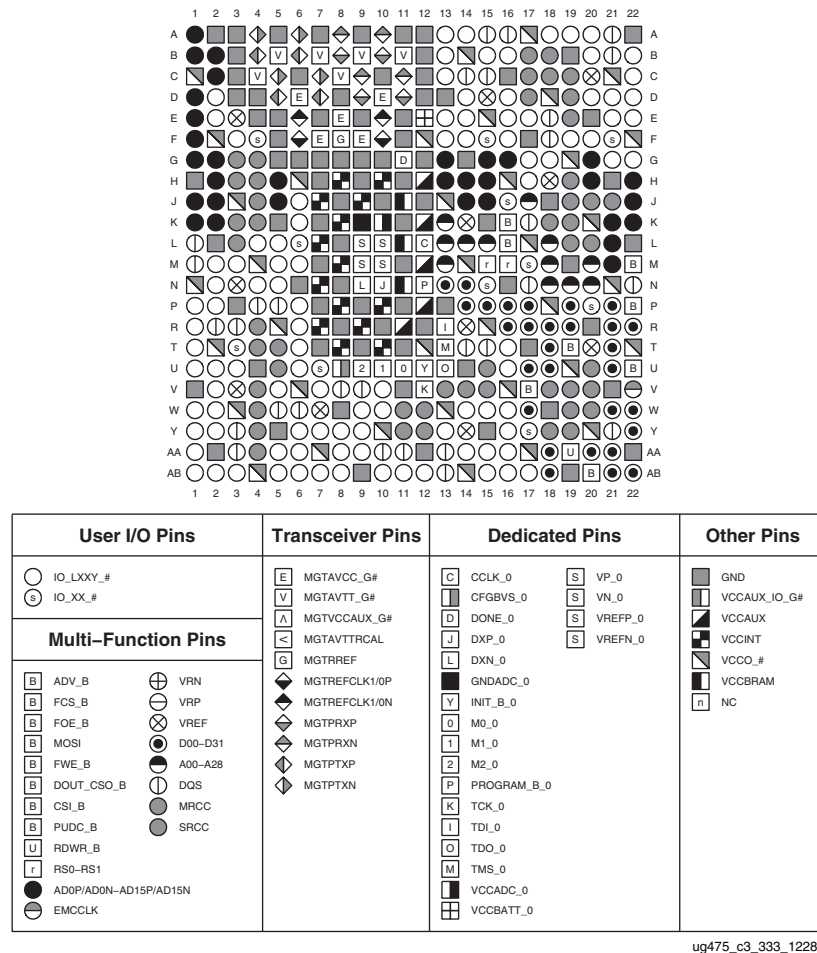

Figure 3-21: FBG484/RB484 Packages—7A200T Pinout Diagram

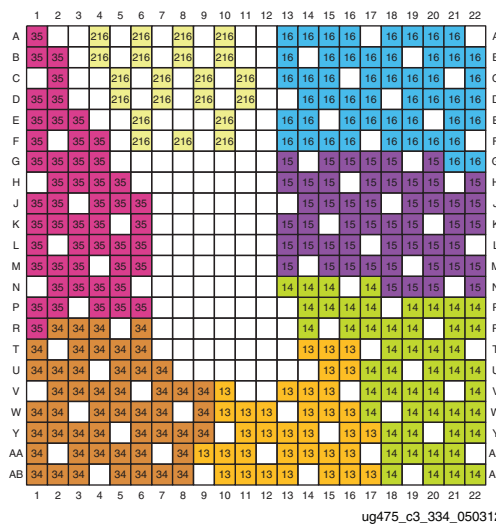

Figure 3-22: FBG484/RB484 Packages—7A200T I/O Banks



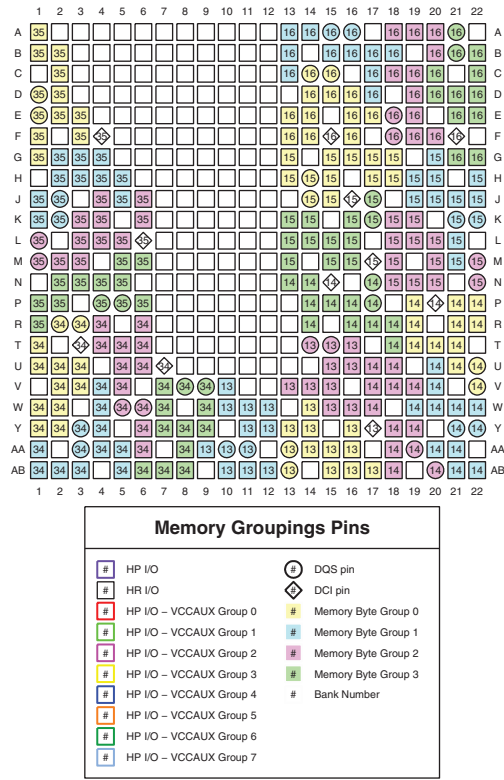
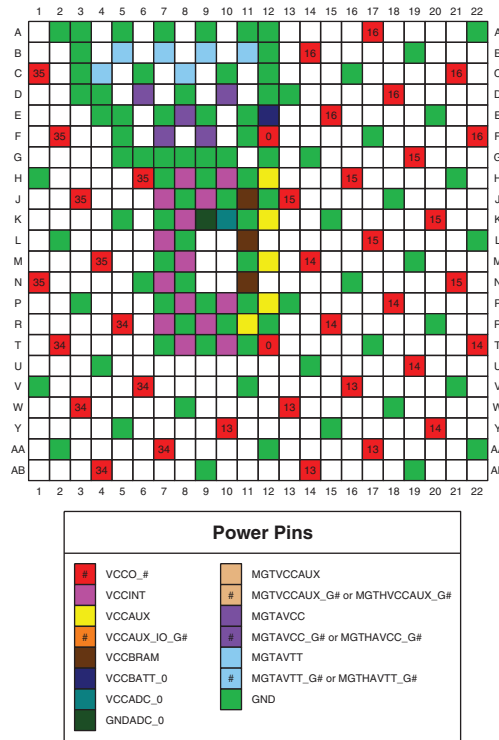

Figure 3-23: FBG484/RB484 Packages—7A200T Memory Groupings



ug475\_c3\_336\_122811

Figure 3-24: FBG484/RB484 Packages—7A200T Power and GND Placement

### FBG676/RB676 Packages—7A200T

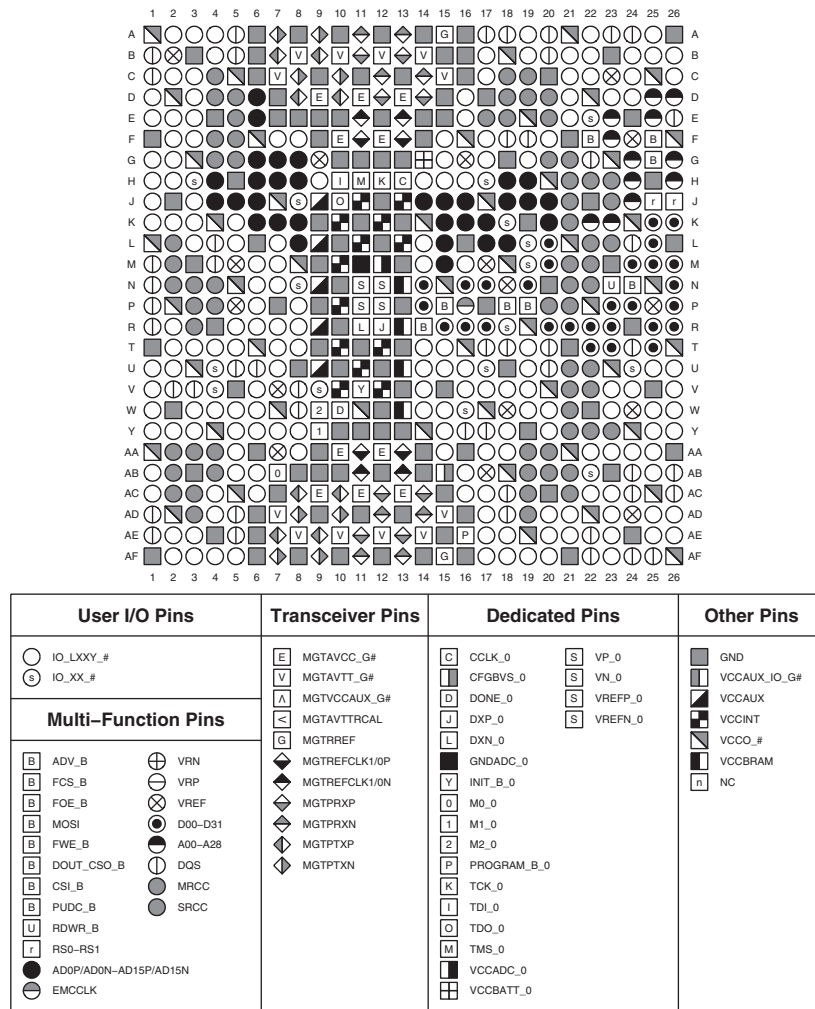

ug475\_c3\_337\_013113

Figure 3-25: FBG676/RB676 Packages—7A200T Pinout Diagram

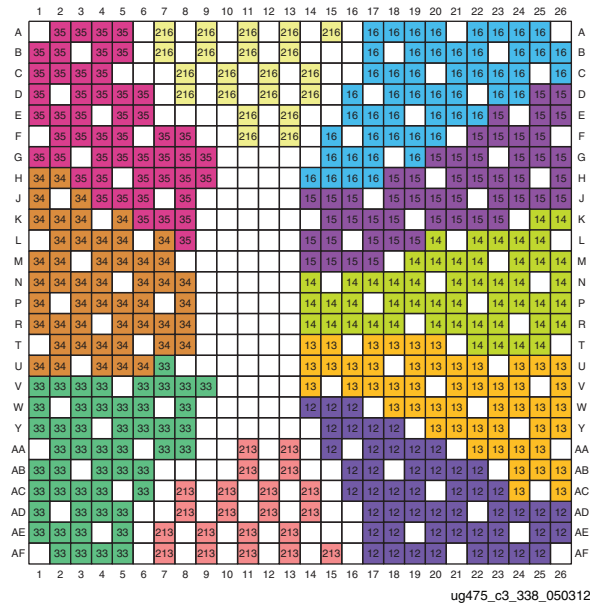

Figure 3-26: FBG676/RB676 Packages—7A200T I/O Banks

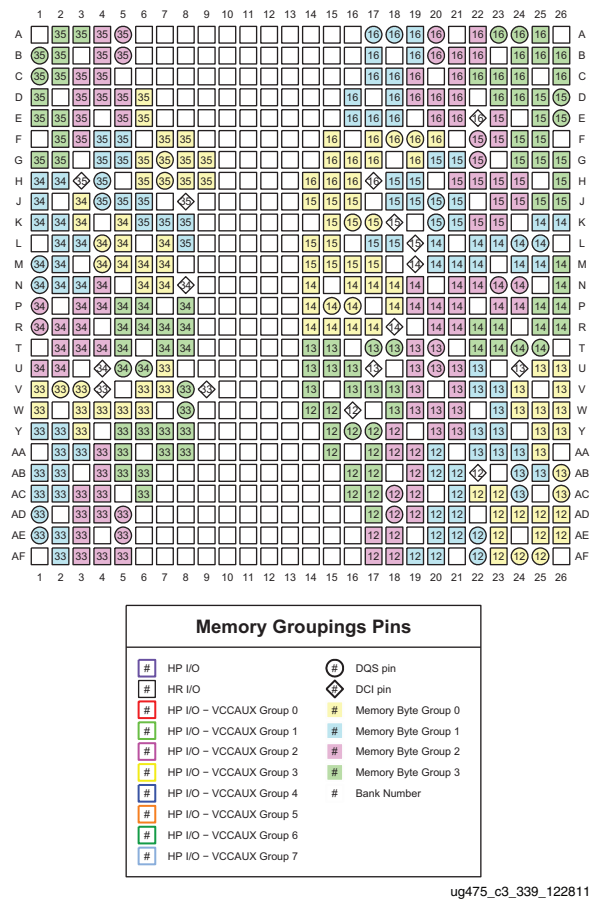
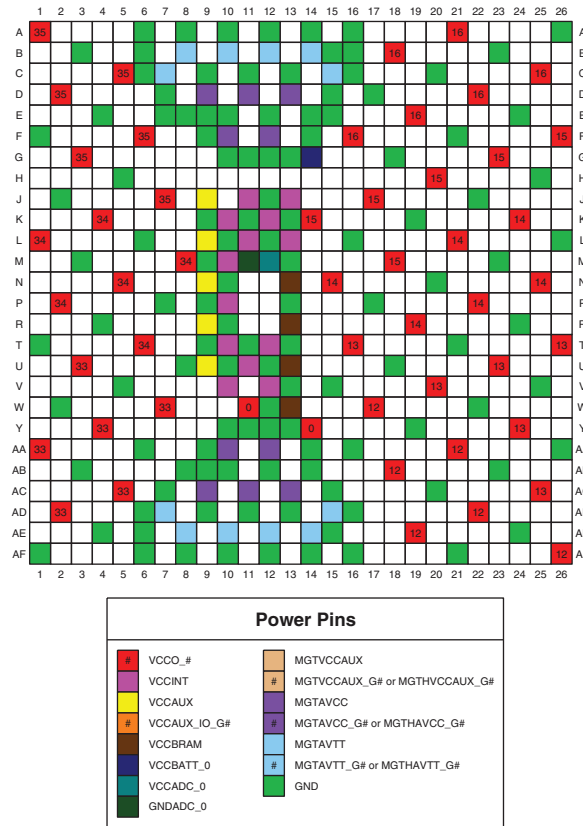

Figure 3-27: FBG676/RB676 Packages—7A200T Memory Groupings



ug475\_c3\_340\_122811

Figure 3-28: FBG676/RB676 Packages—7A200T Power and GND Placement

## FFG1156 Package—7A200T

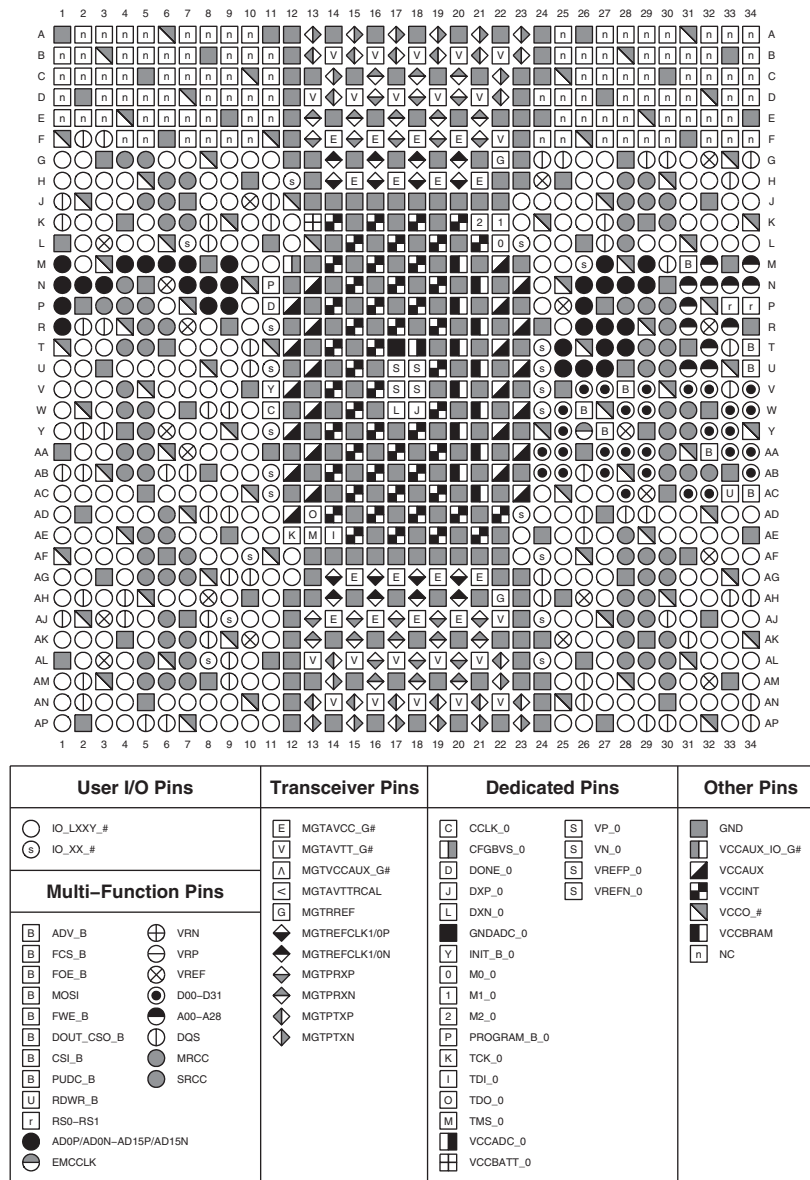

ug475\_c3\_341\_122811

Figure 3-29: FFG1156 Package—7A200T Pinout Diagram

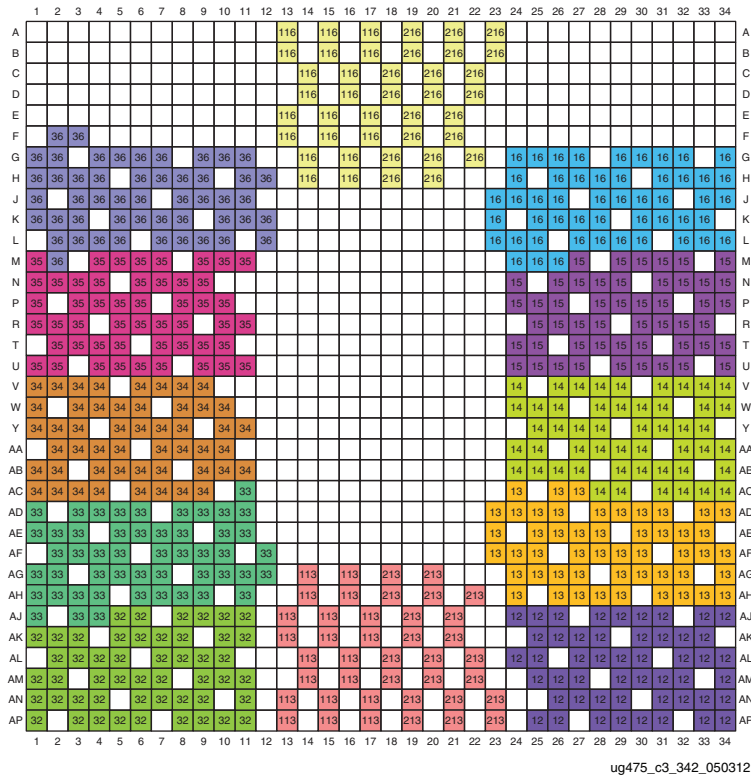
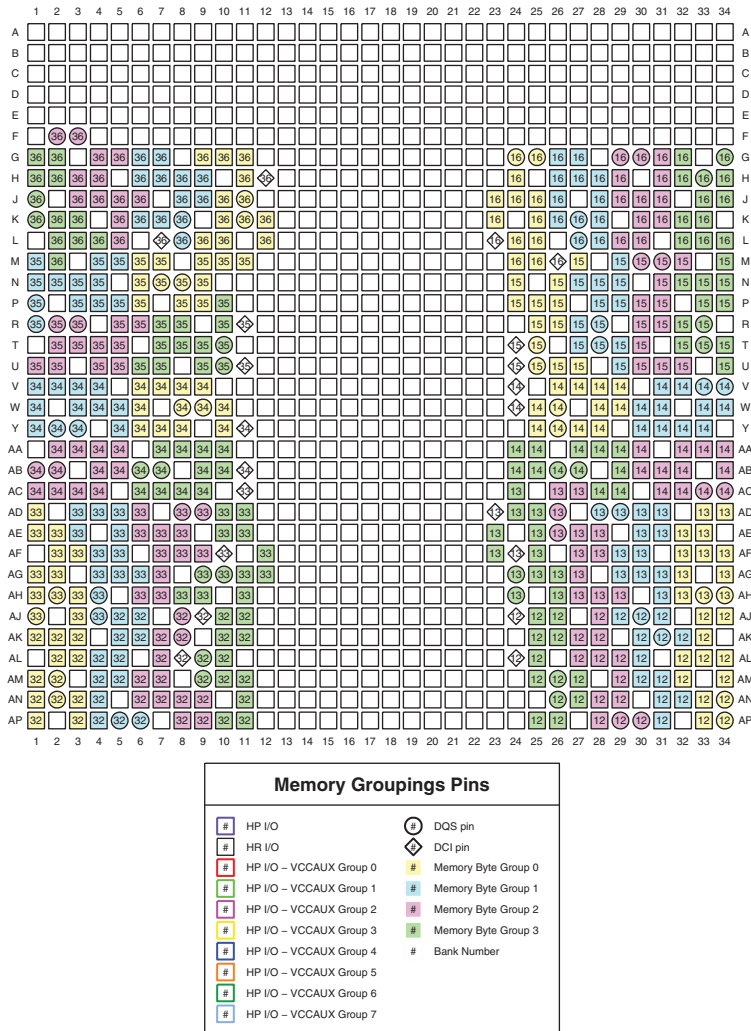

Figure 3-30: FFG1156 Package—7A200T I/O Banks



ug475\_c3\_343\_122811

Figure 3-31: FFG1156 Package—7A200T Memory Groupings



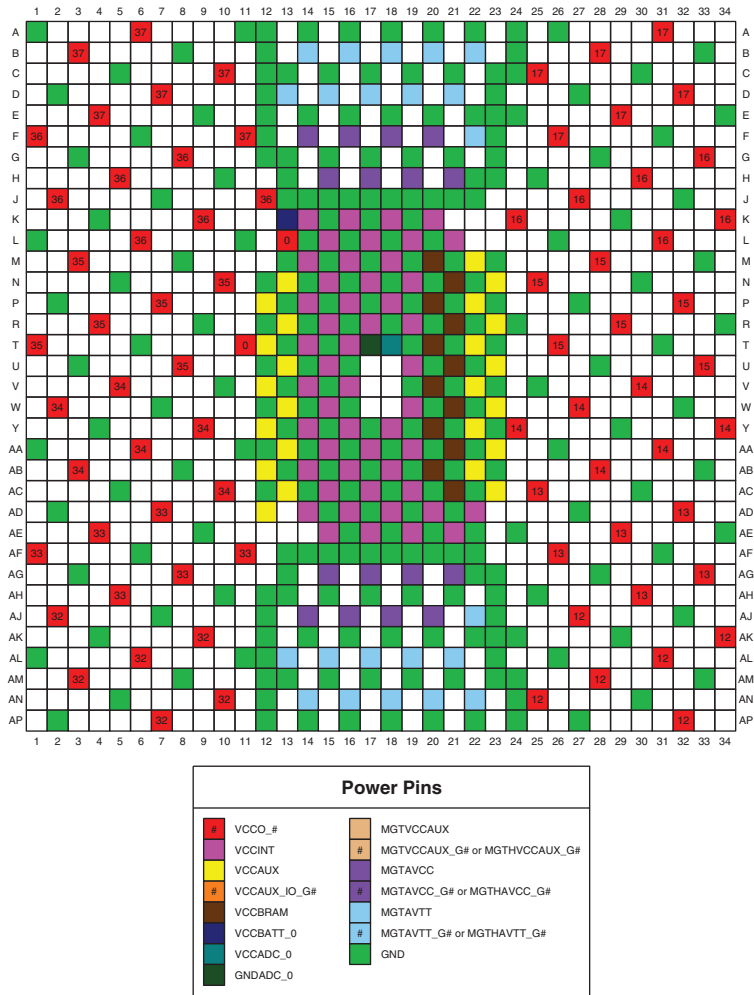

ug475\_c3\_344\_122811

Figure 3-32: FFG1156 Package—7A200T Power and GND Placement

# Kintex-7 FPGAs Device Diagrams

Table 3-2: Kintex-7 FPGAs Device Diagrams Cross-Reference

Device	FB/FBG484	FB/FBG676	FB/FBG900	FF/FFG676 RF676	FF/FFG900 RF900	FF/FFG901	FF/FFG1156
7K70T	<a href="#">page 82</a>	<a href="#">page 85</a>					
7K160T	<a href="#">page 82</a>	<a href="#">page 88</a>		<a href="#">page 95</a>			
7K325T		<a href="#">page 88</a>	<a href="#">page 91</a>	<a href="#">page 95</a>	<a href="#">page 98</a>		
7K355T						<a href="#">page 102</a>	
7K410T		<a href="#">page 88</a>	<a href="#">page 91</a>	<a href="#">page 95</a>	<a href="#">page 98</a>		
7K420T						<a href="#">page 106</a>	<a href="#">page 110</a>
7K480T						<a href="#">page 106</a>	<a href="#">page 110</a>

## FB/FBG484 Packages—7K70T and 7K160T

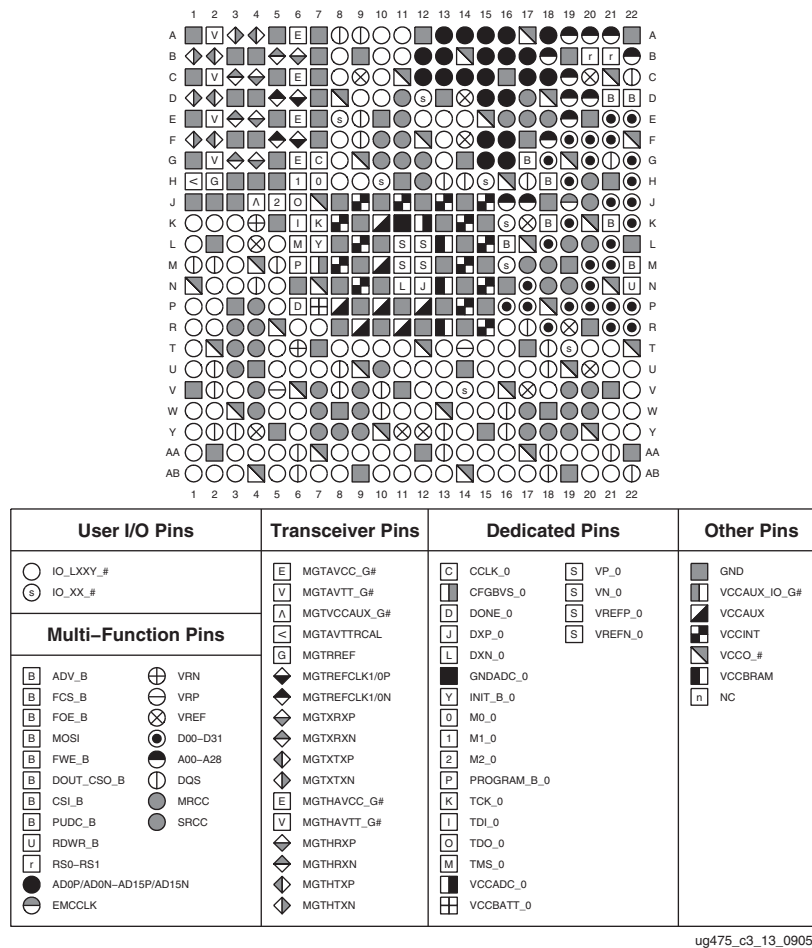

Figure 3-33: FB/FBG484 Packages—7K70T and 7K160T Pinout Diagram

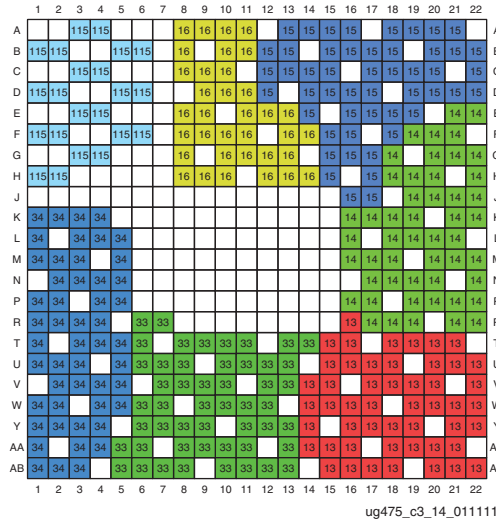

Figure 3-34: FB/FBG484 Packages—7K70T and 7K160T I/O Banks

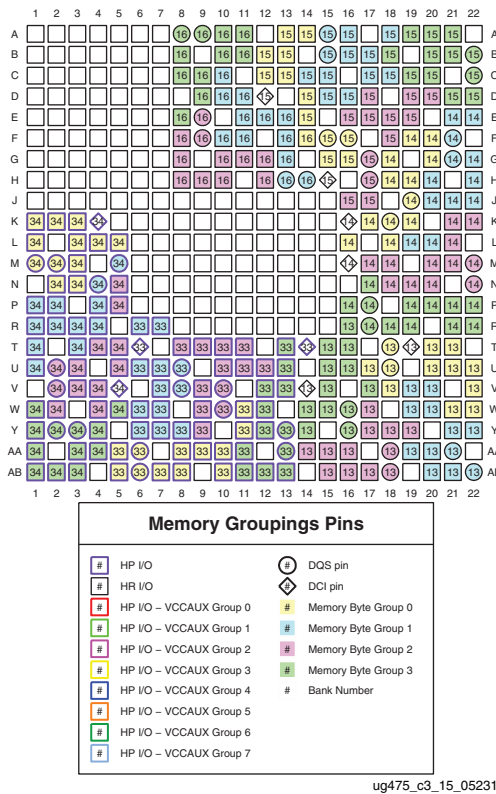
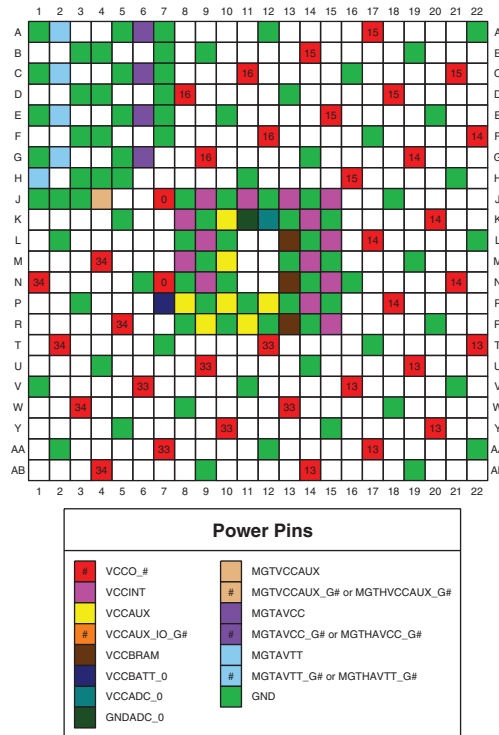

Figure 3-35: FB/FBG484 Packages—7K70T and 7K160T Memory Groupings



ug475\_c3\_16\_052311

Figure 3-36: FB/FBG484 Packages—7K70T and 7K160T Power and GND Placement

### FB/FBG676 Packages—7K70T

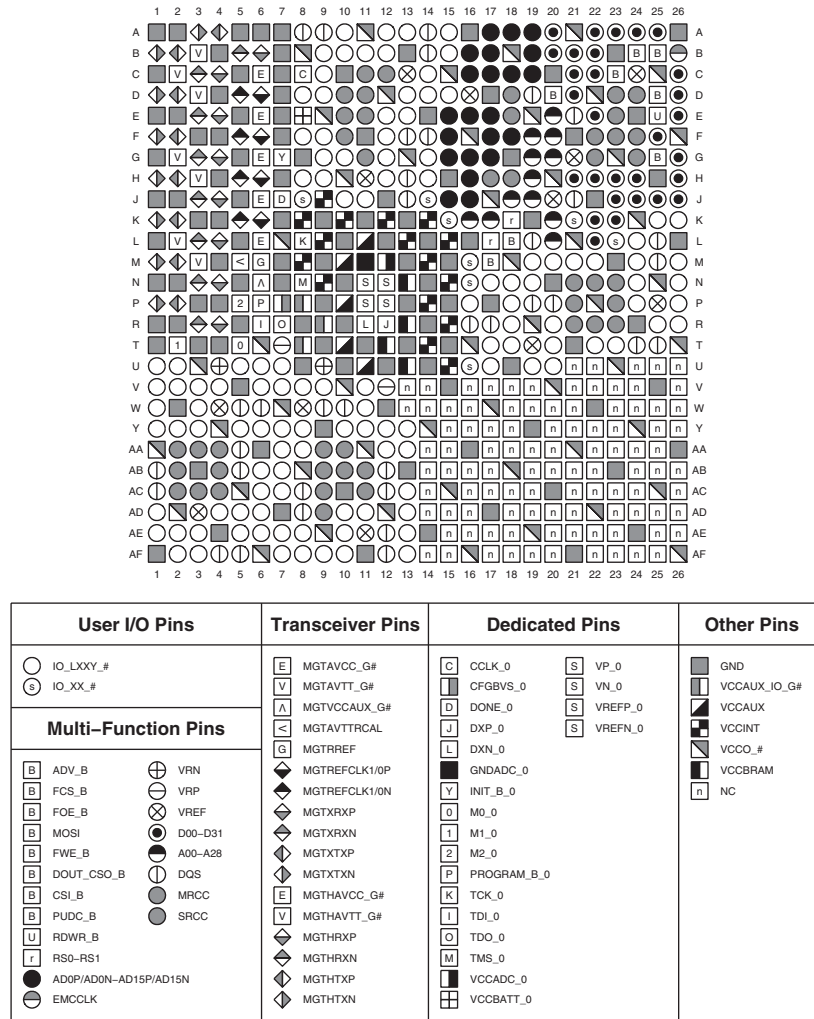

ug475\_c3\_05\_090511

Figure 3-37: FB/FBG676 Packages—7K70T Pinout Diagram



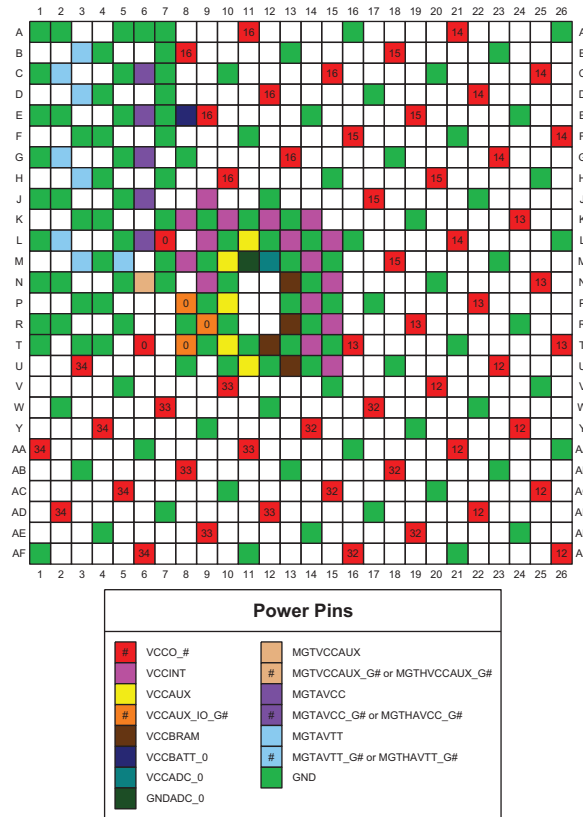

ug475\_c3\_08\_052311

Figure 3-40: FB/FBG676 Packages—7K70T Power and GND Placement

## FB/FBG676 Packages—7K160T, 7K325T, and 7K410T

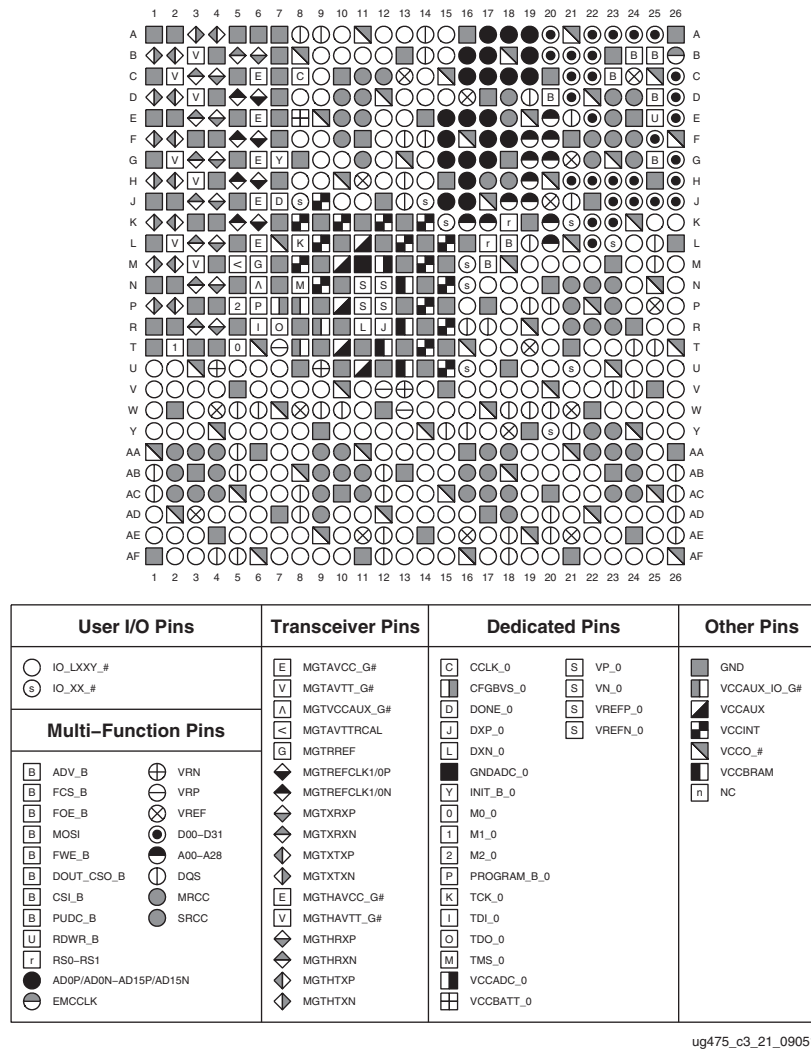

Figure 3-41: FB/FBG676 Packages—7K160T, 7K325T, and 7K410T Pinout Diagram



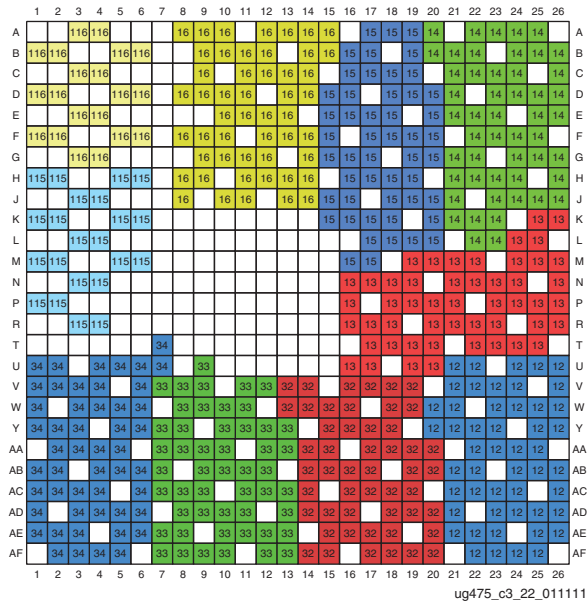

Figure 3-42: FB/FBG676 Packages—7K160T, 7K325T, and 7K410T I/O Banks

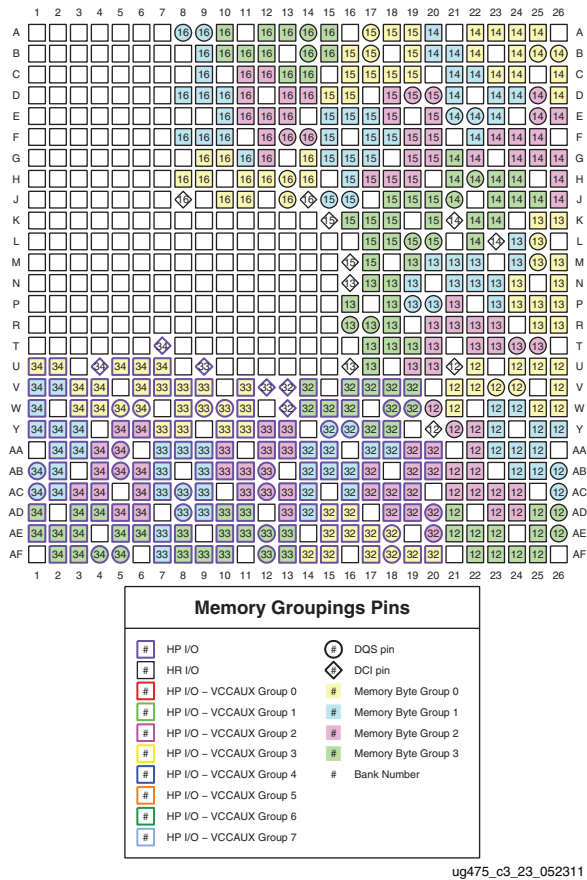
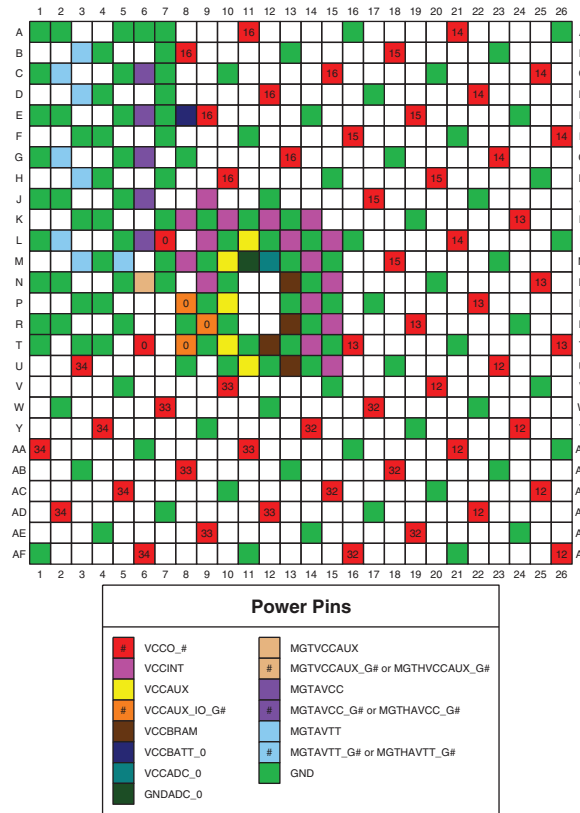

Figure 3-43: FB/FBG676 Packages—7K160T, 7K325T, and 7K410T Memory Groupings



ug475\_c3\_24\_052311

Figure 3-44: FB/FBG676 Packages—7K160T, 7K325T, and 7K410T Power and GND Placement

## FB/FBG900 Packages—7K325T and 7K410T

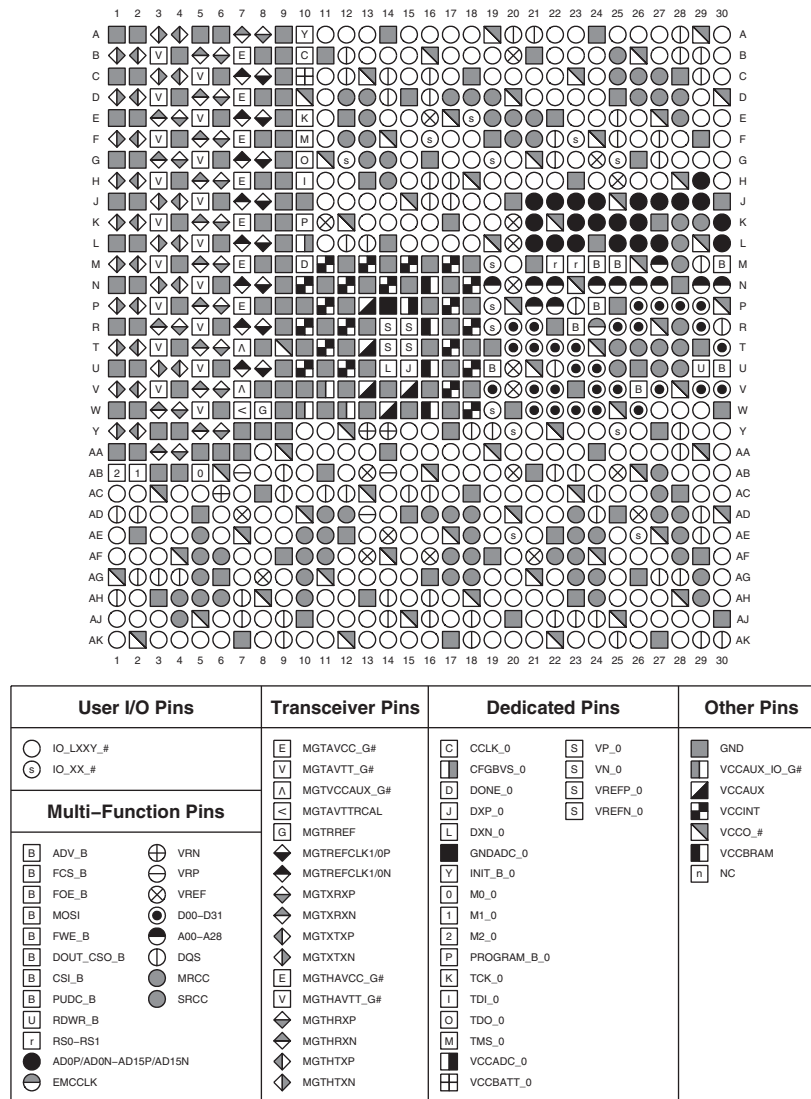

ug475\_c3\_25\_090511

Figure 3-45: FB/FBG900 Packages—7K325T and 7K410T Pinout Diagram

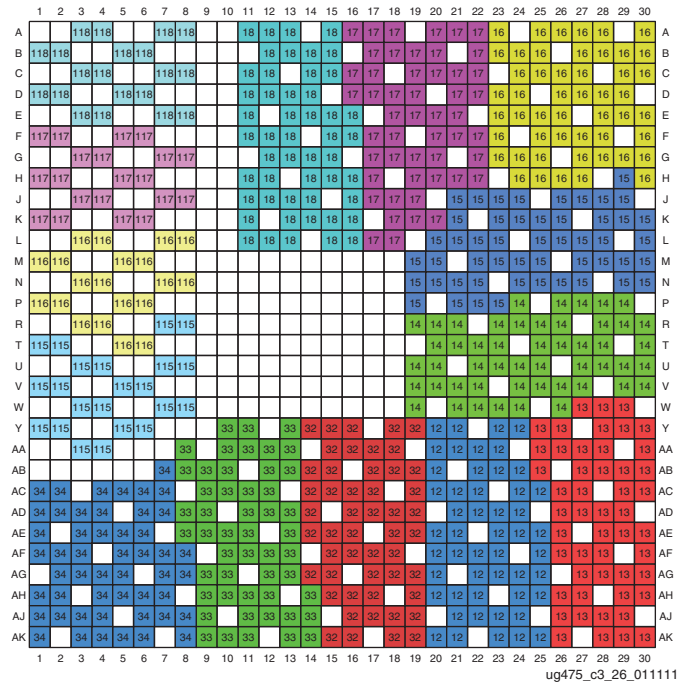
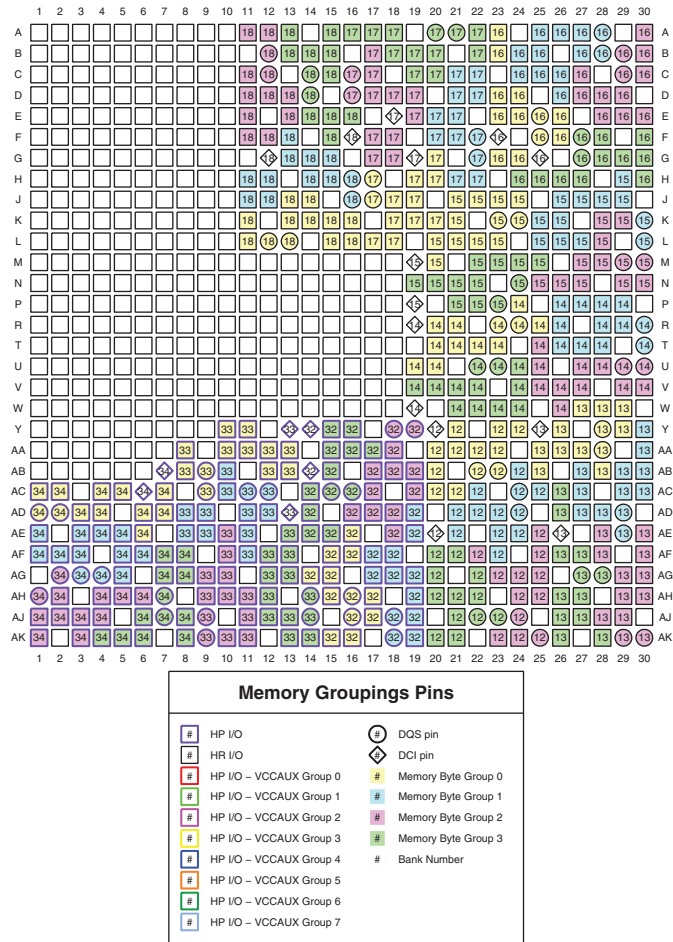
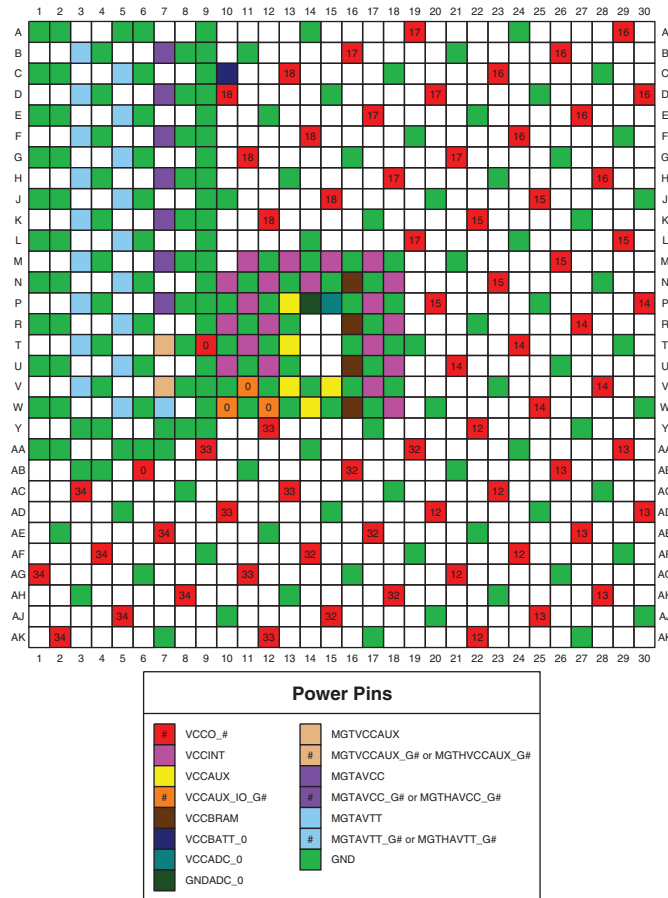

Figure 3-46: FB/FBG900 Packages—7K325T and 7K410T I/O Banks



ug475\_c3\_27\_052311

Figure 3-47: FB/FBG900 Packages—7K325T and 7K410T Memory Groupings



ug475\_c3\_28\_052311

Figure 3-48: FB/FBG900 Packages—7K325T and 7K410T Power and GND Placement

## FF/FFG676 or RF676 Packages—7K160T, 7K325T, and 7K410T

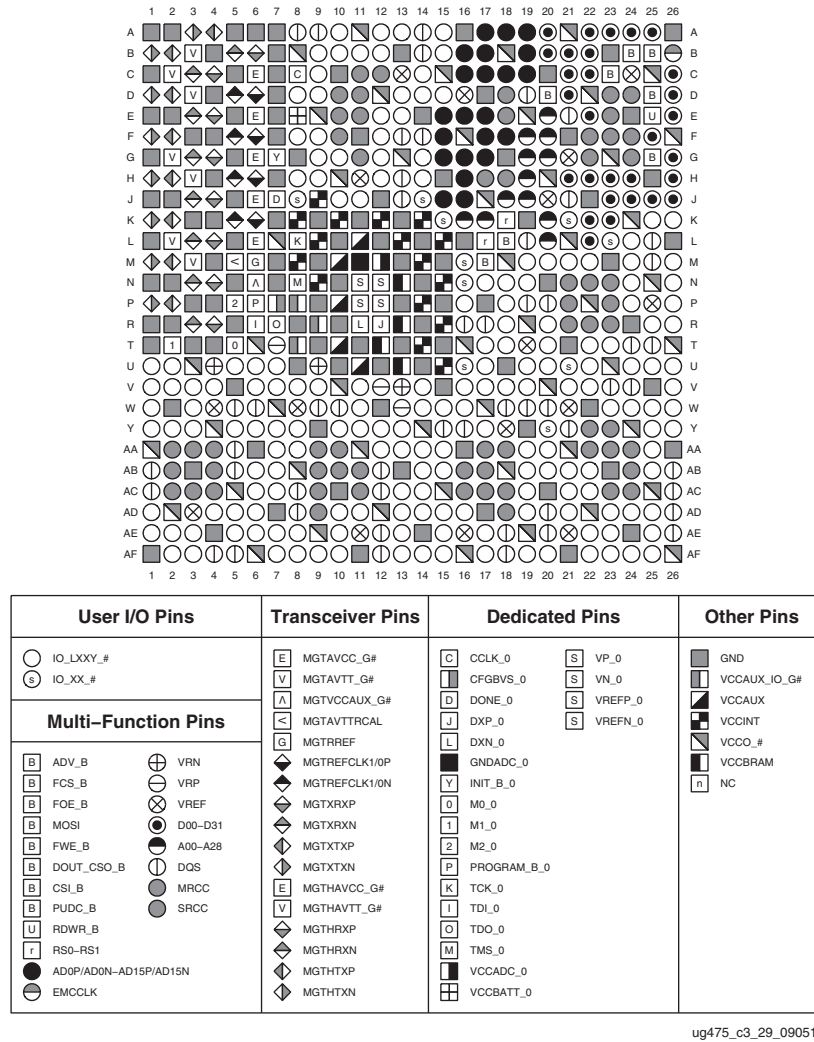

Figure 3-49: FF/FFG676 and RF676 Packages—7K160T, 7K325T, and 7K410T Pinout Diagram

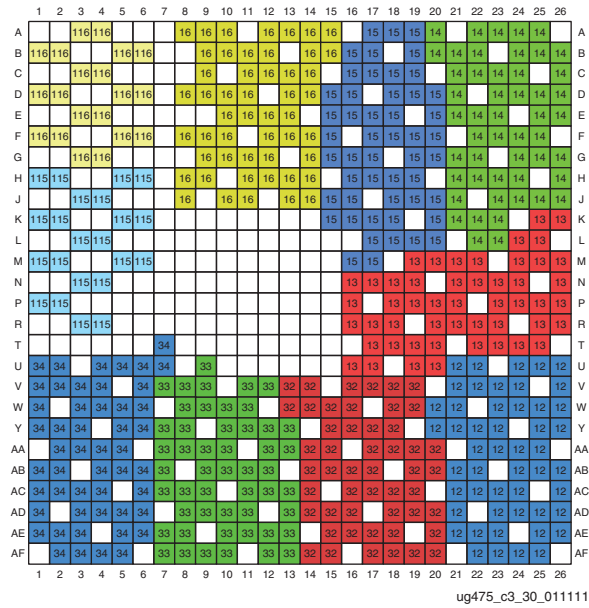

Figure 3-50: FF/FFG676 and RF676 Packages—7K160T, 7K325T, and 7K410T I/O Banks

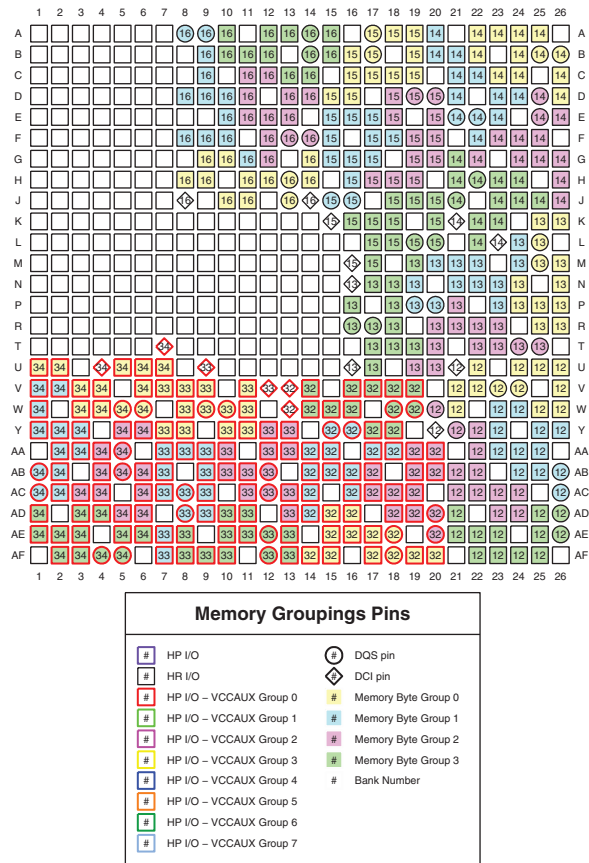
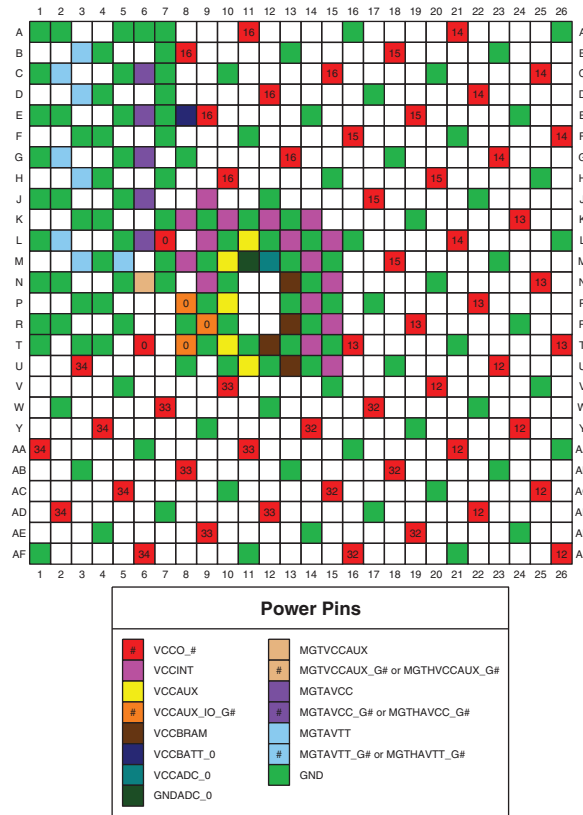

Figure 3-51: FF/FFG676 and RF676 Packages—7K160T, 7K325T, and 7K410T Memory Groupings





ug475\_c3\_32\_052311

Figure 3-52: FF/FFG676 and RF676 Packages—7K160T, 7K325T, and 7K410T Power and GND Placement

## FF/FFG900 and RF900 Packages—7K325T and 7K410T

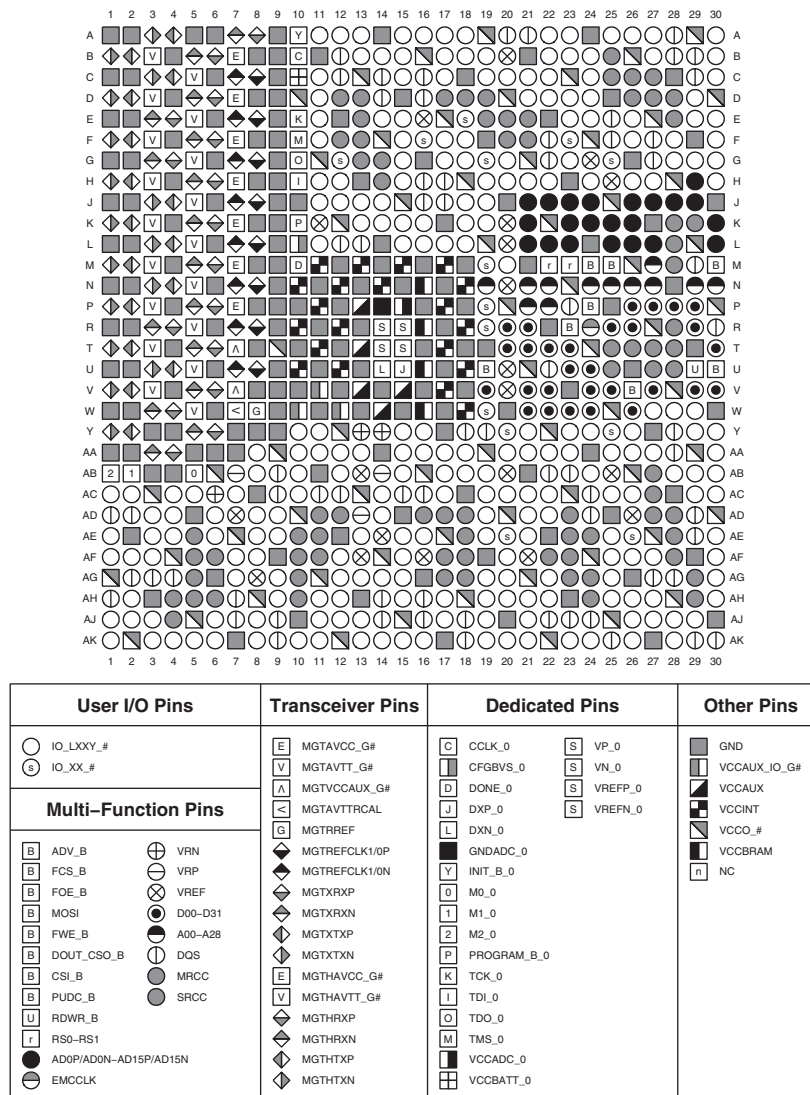

ug475\_c3\_33\_090511

Figure 3-53: FF/FFG900 and RF900 Packages—7K325T and 7K410T Pinout Diagram

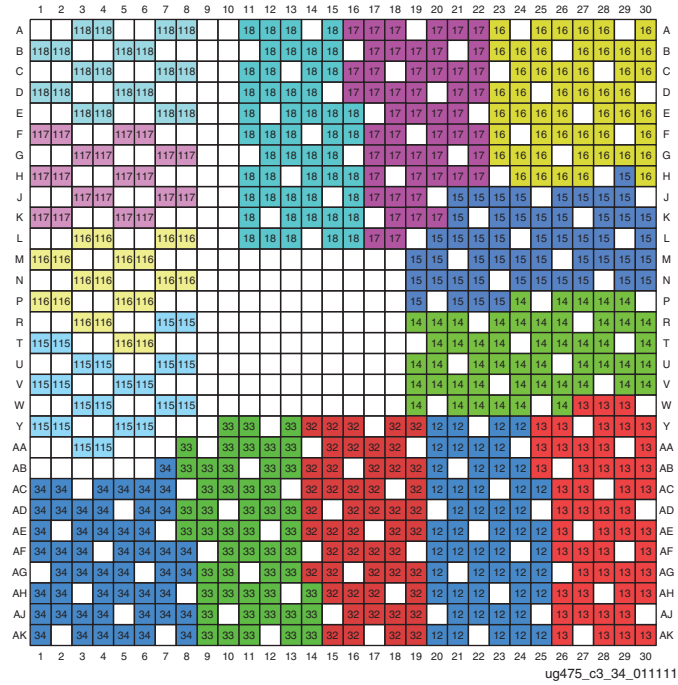

Figure 3-54: FF/FFG900 and RF900 Packages—7K325T and 7K410T I/O Banks

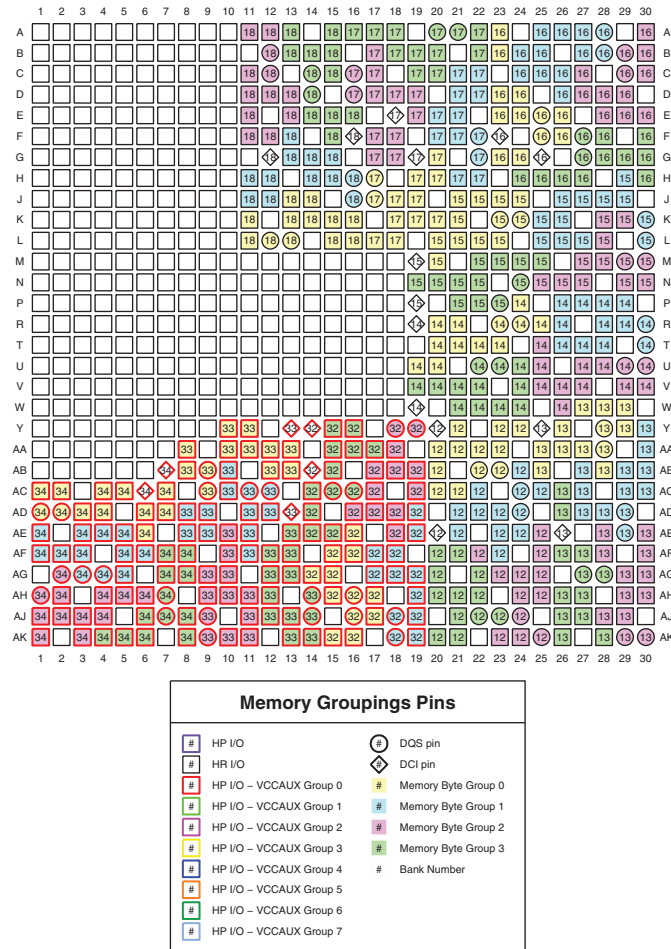
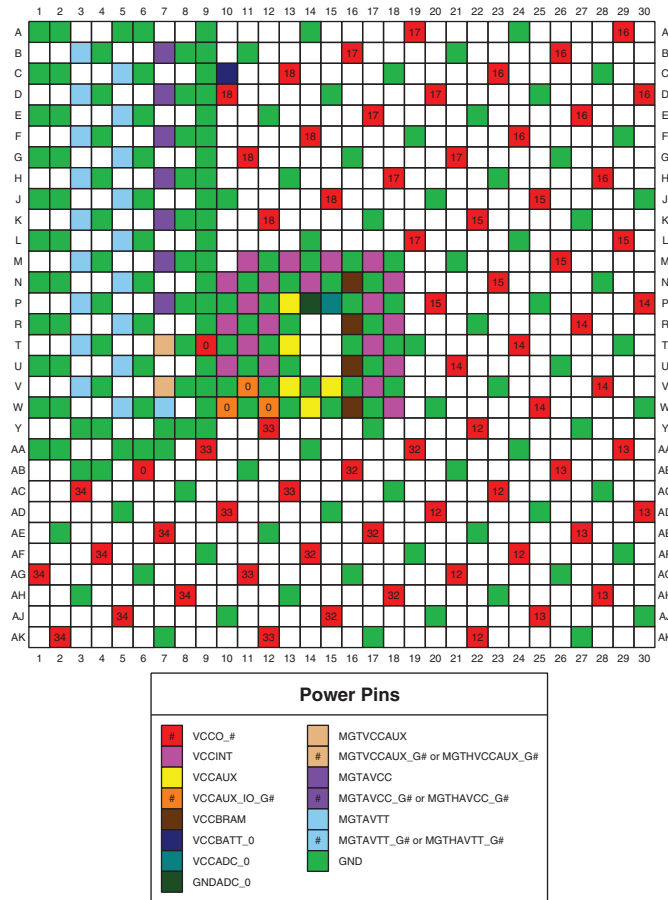

Figure 3-55: FF/FG900 and RF900 Packages—7K325T and 7K410T Memory Groupings



ug475\_c3\_36\_052311

Figure 3-56: FF/FFG900 and RF900 Packages—7K325T and 7K410T Power and GND Placement

## FF/FFG901 Packages—7K355T

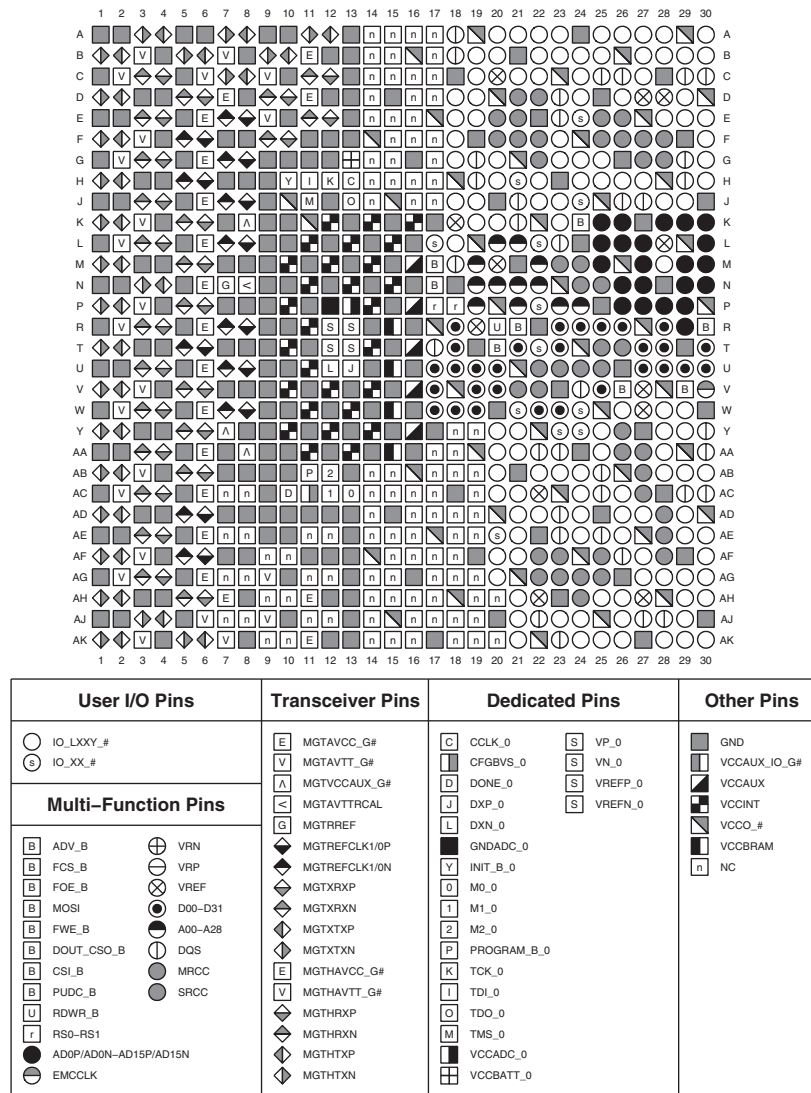

ug475\_c3\_37\_090511

Figure 3-57: FF/FFG901 Packages—7K355T Pinout Diagram

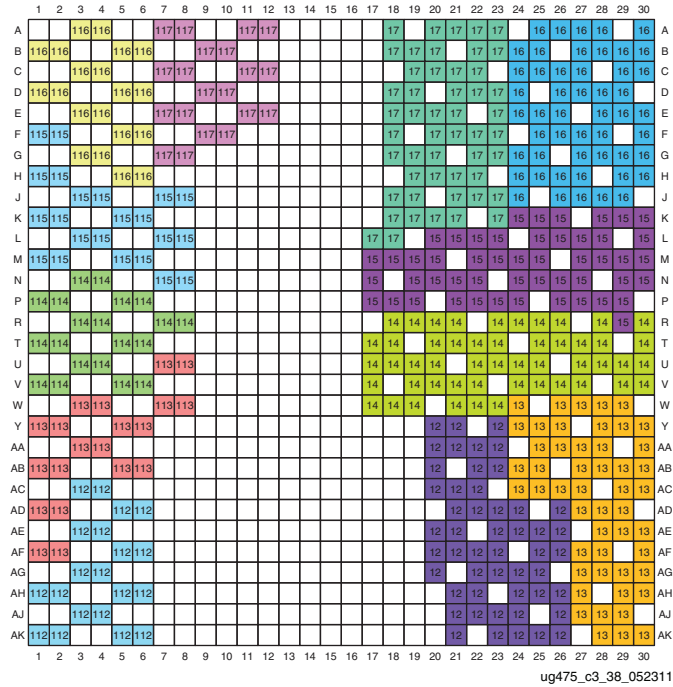
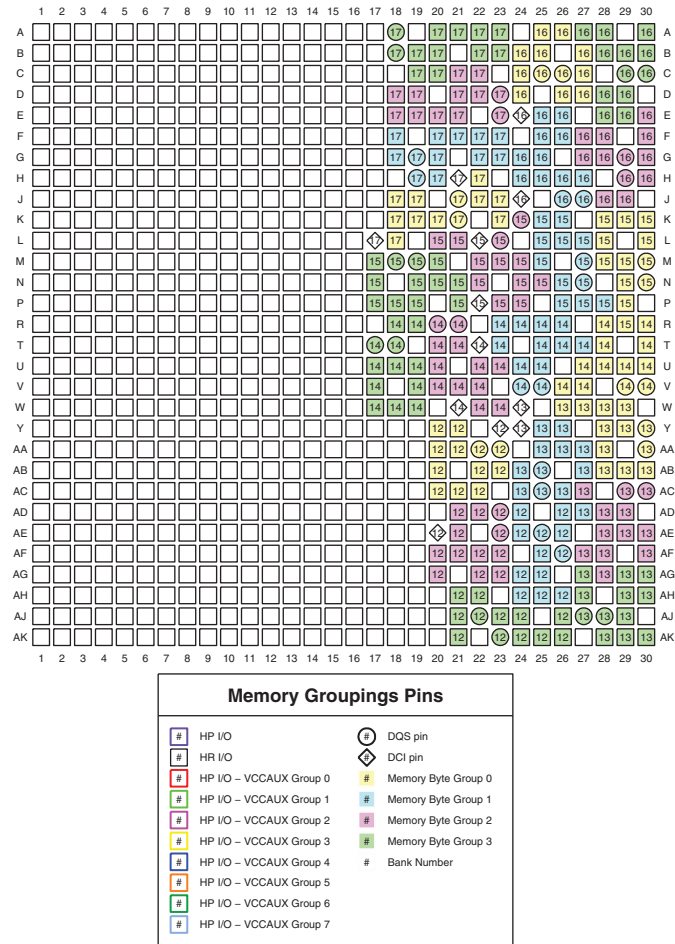

Figure 3-58: FF/FFG901 Package—7K355T I/O Banks



ug475\_c3\_39\_052311

Figure 3-59: FF/FFG901 Package—7K355T Memory Groupings



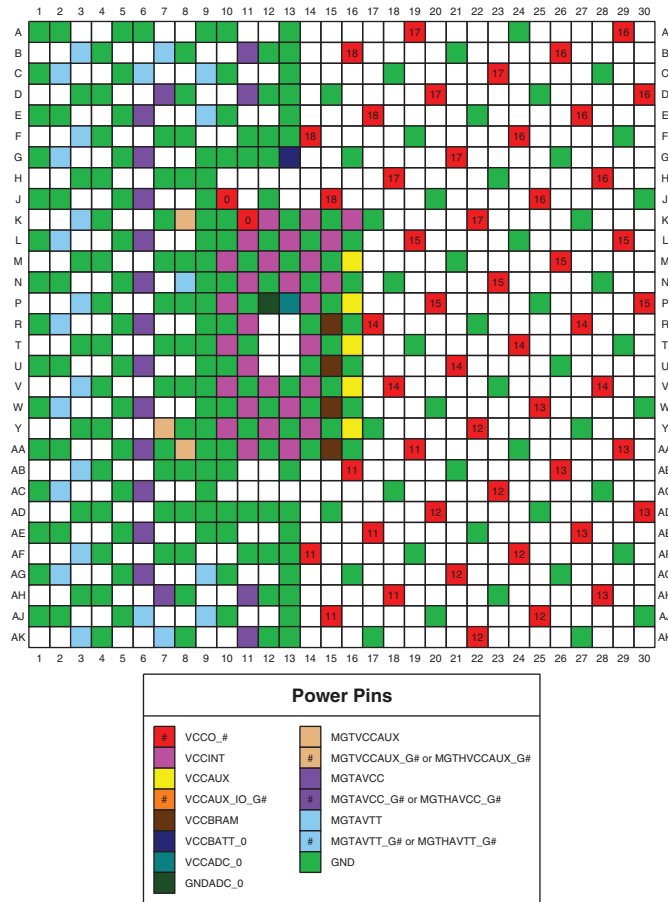

ug475\_c3\_40\_052311

Figure 3-60: FF/FFG901 Package—7K355T Power and GND Placement

## FF/FFG901 Packages—7K420T and 7K480T

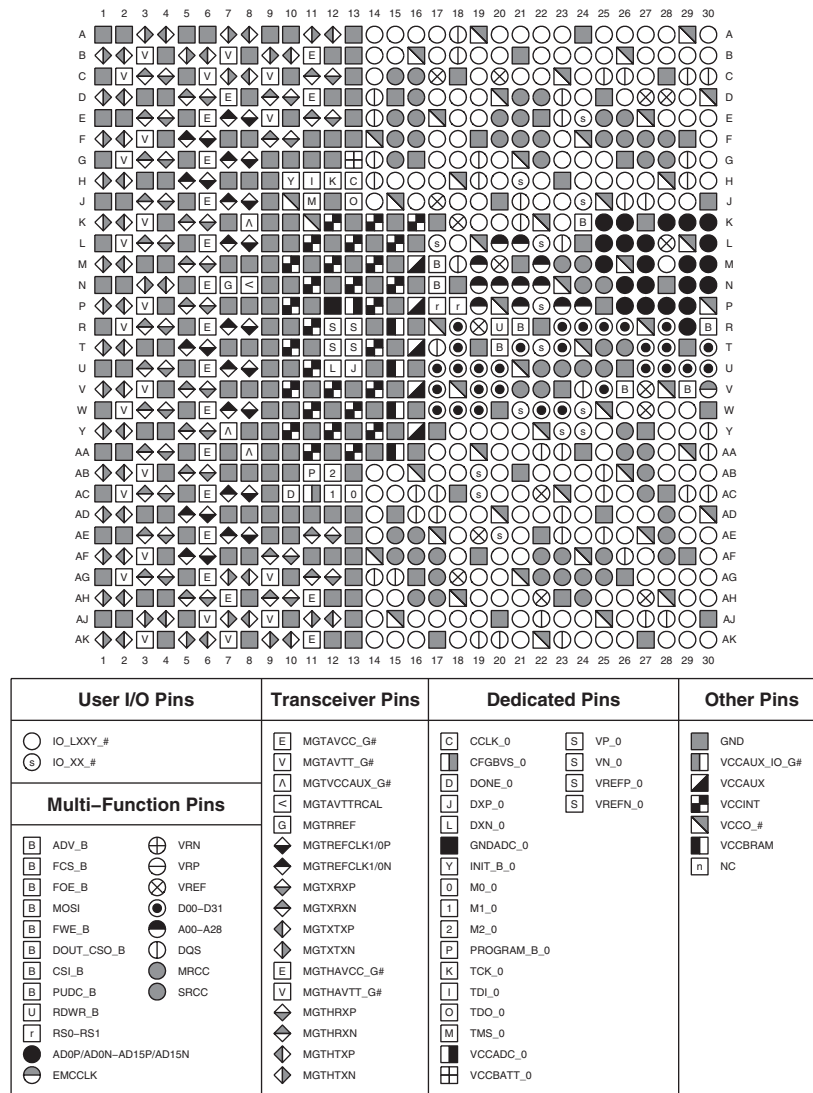

ug475\_c3\_45\_090511

Figure 3-61: FF/FFG901 Packages—7K420T and 7K480T Pinout Diagram

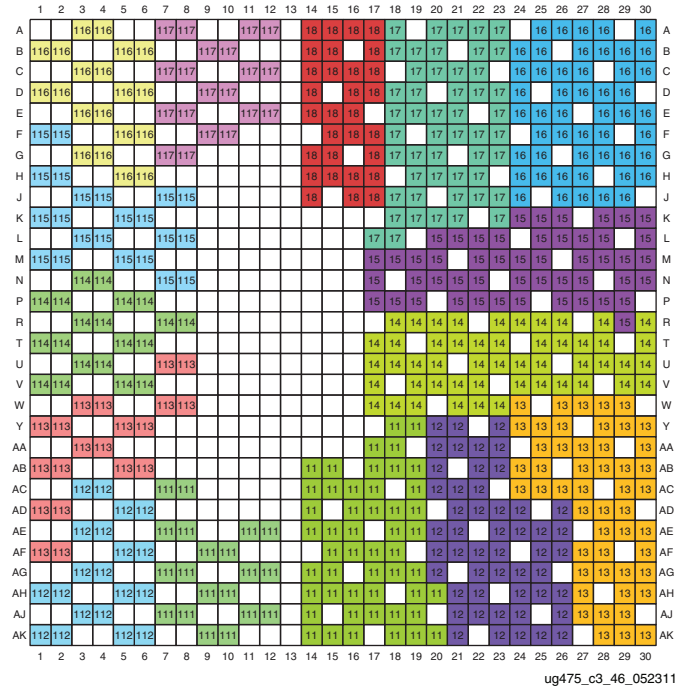
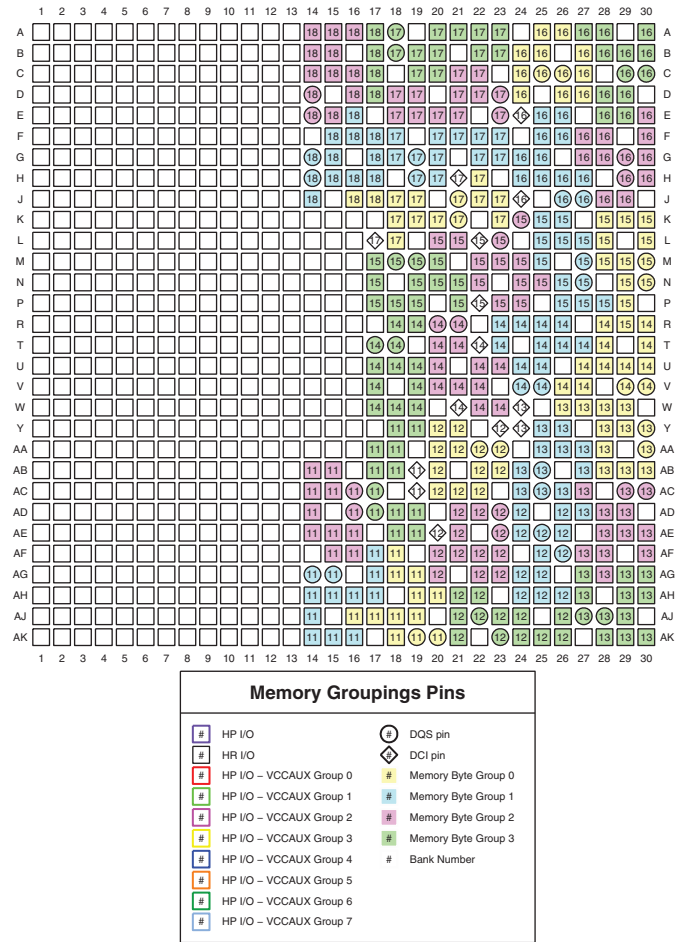
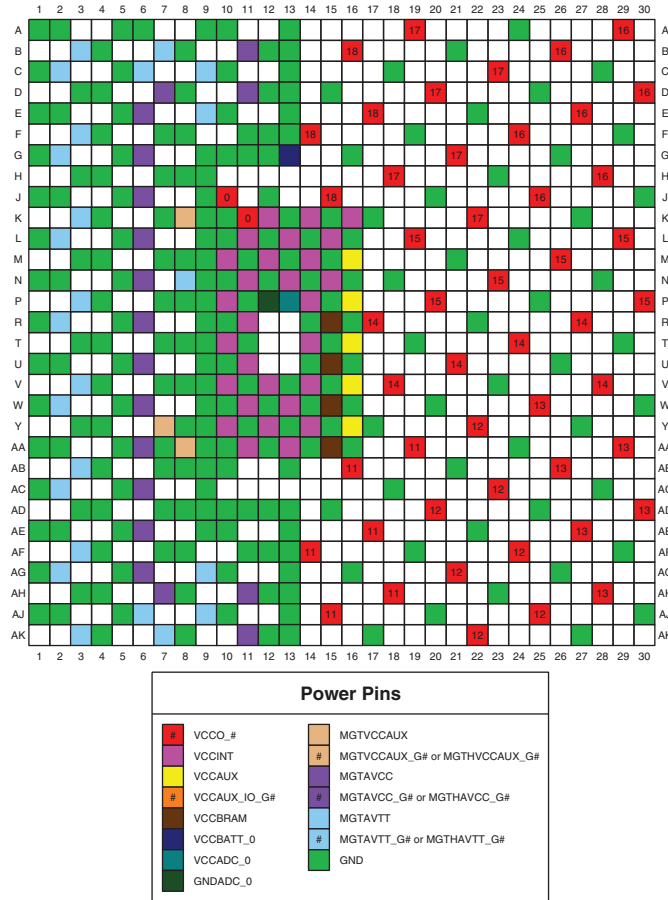

Figure 3-62: FF/FFG901 Packages—7K420T and 7K480T I/O Banks



ug475\_c3\_47\_052311

Figure 3-63: FF/FG901 Packages—7K420T and 7K480T Memory Groupings



ug475\_c3\_48\_052311

Figure 3-64: FF/FFG901 Packages—7K420T and 7K480T Power and GND Placement

## FF/FFG1156 Packages—7K420T and 7K480T

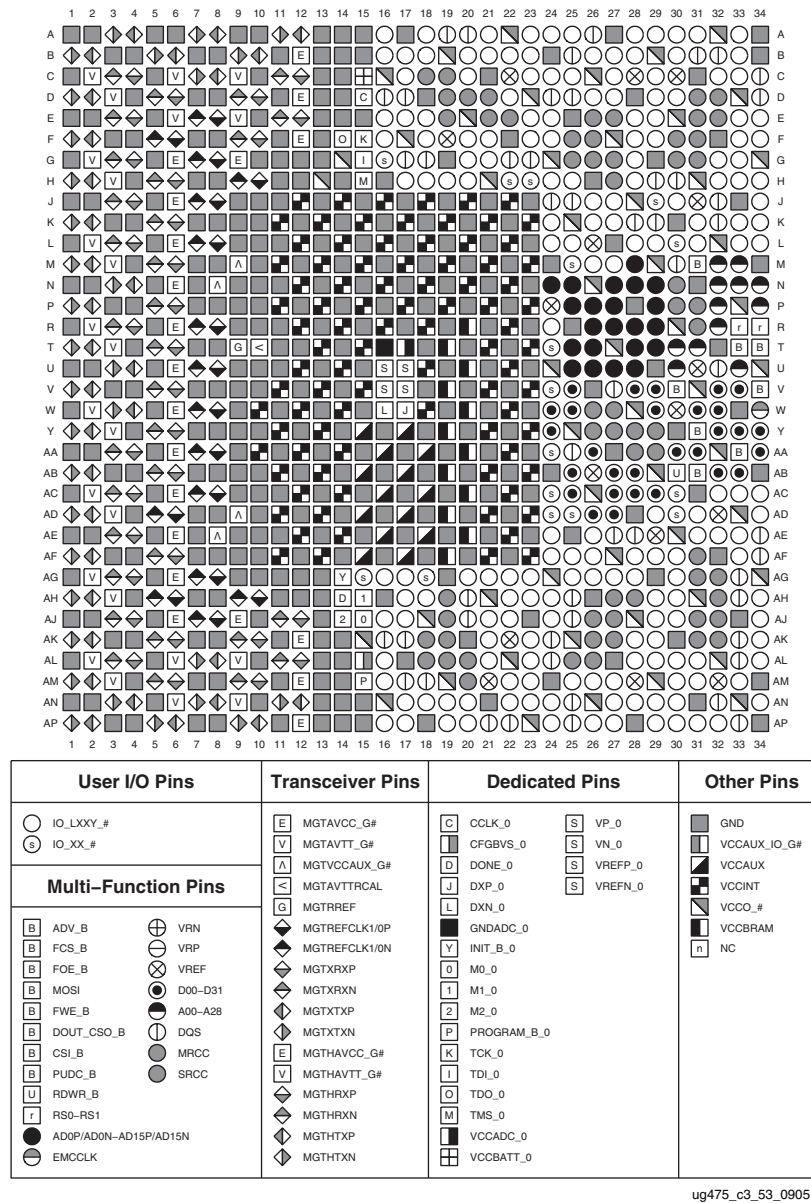
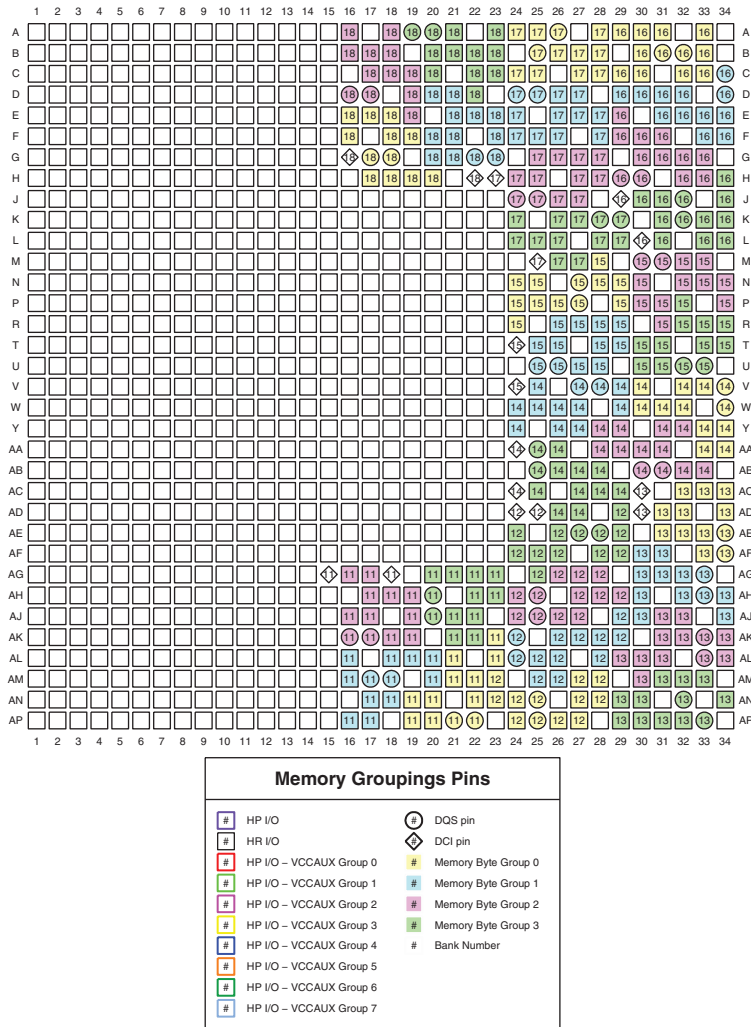

Figure 3-65: FF/FFG1156 Packages—7K420T and 7K480T Pinout Diagram





ug475\_c3\_55\_052311

Figure 3-67: FF/FFG1156 Packages—7K420T and 7K480T Memory Groupings



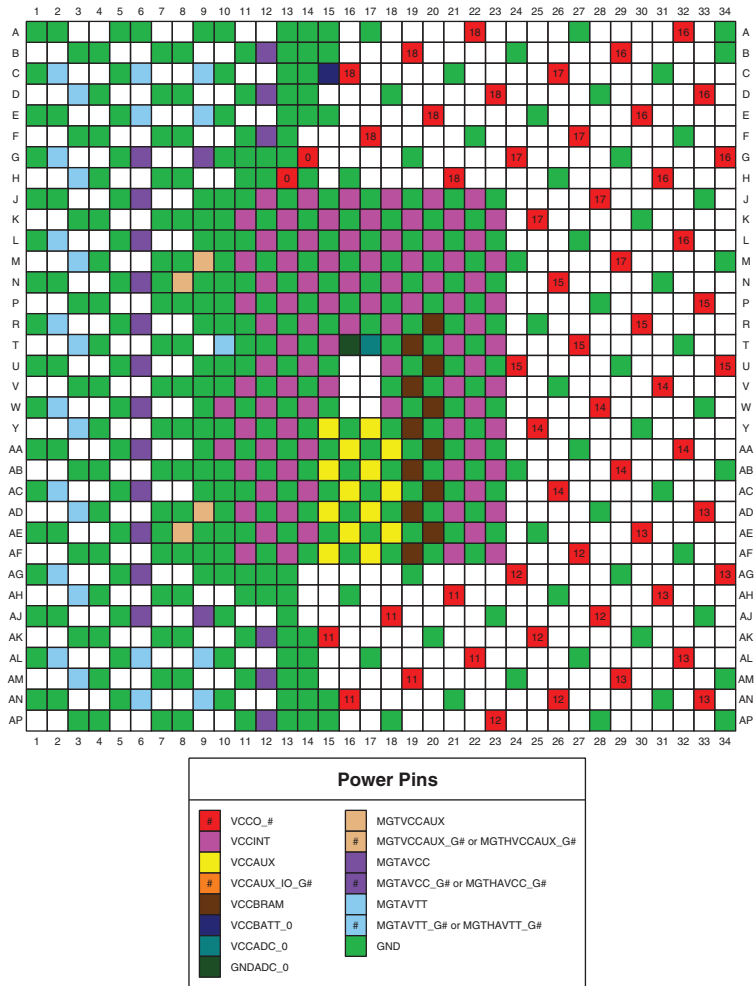

ug475\_c3\_56\_052311

Figure 3-68: FF/FFG1156 Packages—7K420T and 7K480T Power and GND Placement

## Virtex-7 FPGAs Device Diagrams

Table 3-3: Virtex-7 T FPGAs Device Diagrams Cross Reference

Device	FF/FFG1157 RF1157	FF/FFG1761 RF1761	FL/FLG1925	FH/FHG1761
7V585T	<a href="#">page 115</a>	<a href="#">page 119</a>		
7V2000T			<a href="#">page 123</a>	<a href="#">page 127</a>

Table 3-4: Virtex-7 XT FPGAs Device Diagrams Cross Reference

Device	FF/FFG 1157 RF1157	FF/FFG 1158	FF/FFG 1761 RF1761	FF/FFG 1926	FF/FFG 1927	FF/FFG 1928	FF/FFG 1930 RF1930	FL/FLG 1926	FL/FLG 1928	FL/FLG 1930
7VX330T	<a href="#">page 131</a>		<a href="#">page 135</a>							
7VX415T	<a href="#">page 131</a>	<a href="#">page 139</a>			<a href="#">page 143</a>					
7VX485T	<a href="#">page 147</a>	<a href="#">page 151</a>	<a href="#">page 155</a>		<a href="#">page 159</a>		<a href="#">page 163</a>			
7VX550T		<a href="#">page 139</a>			<a href="#">page 175</a>					
7VX690T	<a href="#">page 131</a>	<a href="#">page 139</a>	<a href="#">page 167</a>	<a href="#">page 171</a>	<a href="#">page 175</a>		<a href="#">page 179</a>			
7VX980T				<a href="#">page 171</a>		<a href="#">page 183</a>	<a href="#">page 187</a>			
7VX1140T								<a href="#">page 191</a>	<a href="#">page 195</a>	<a href="#">page 199</a>

## FF/FFG1157 and RF1157 Packages—7V585T

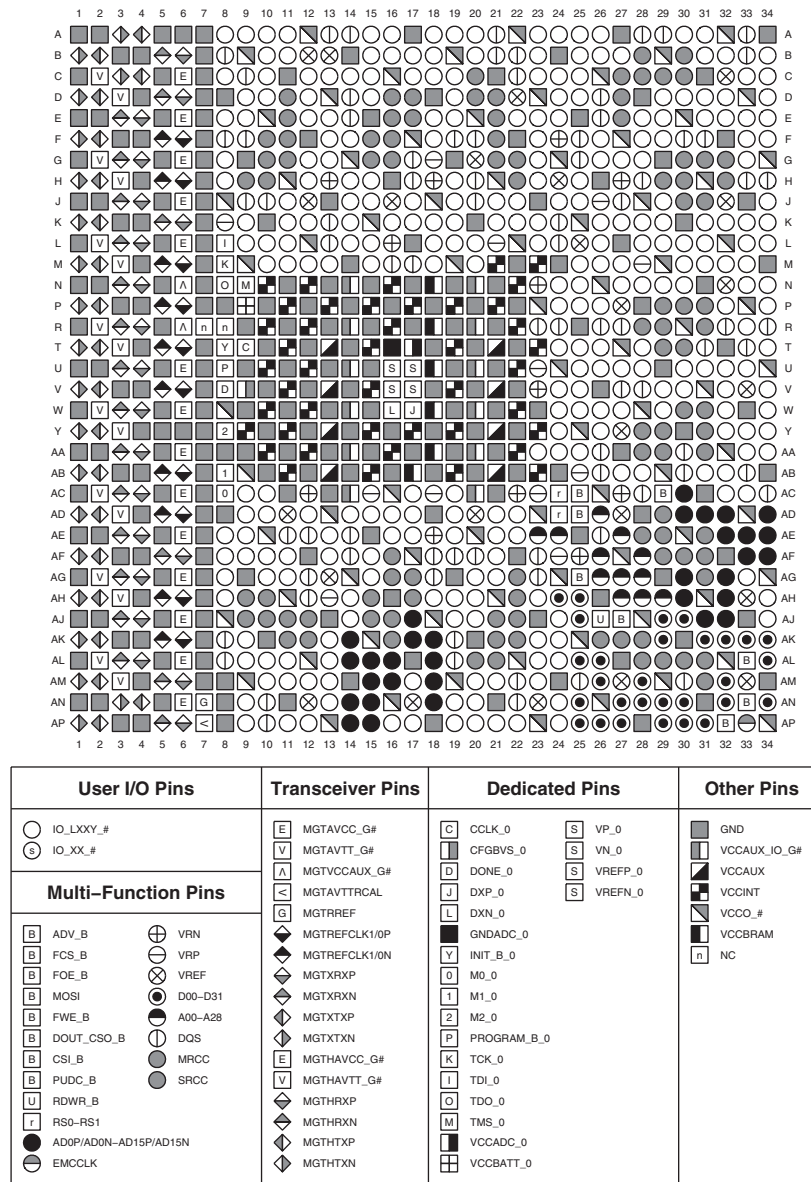

ug475\_c3\_085\_122811

Figure 3-69: FF/FFG1157 and RF1157 Packages—7V585T Pinout Diagram

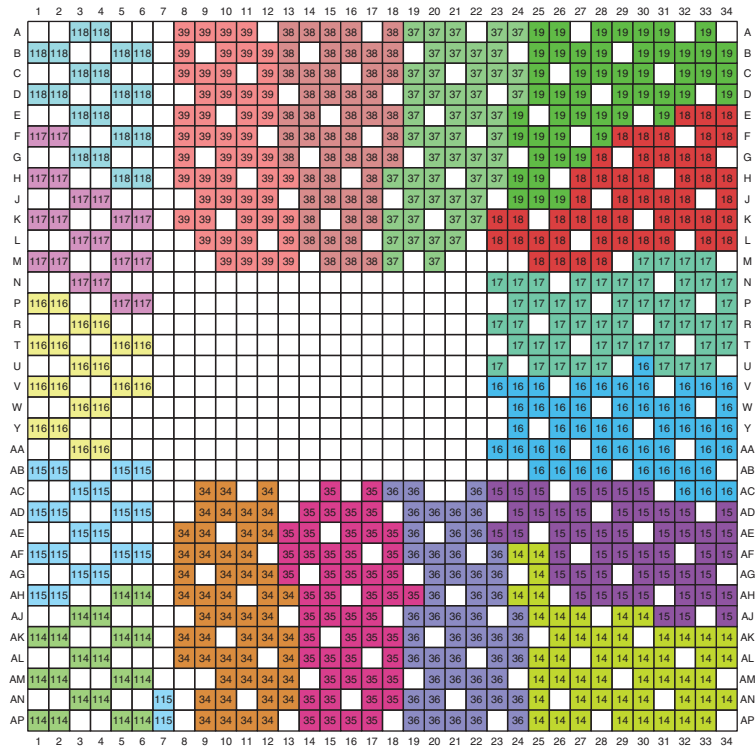

ug475\_c3\_086\_122811

Figure 3-70: FF/FFG1157 and RF1157 Packages—7V585T I/O Banks

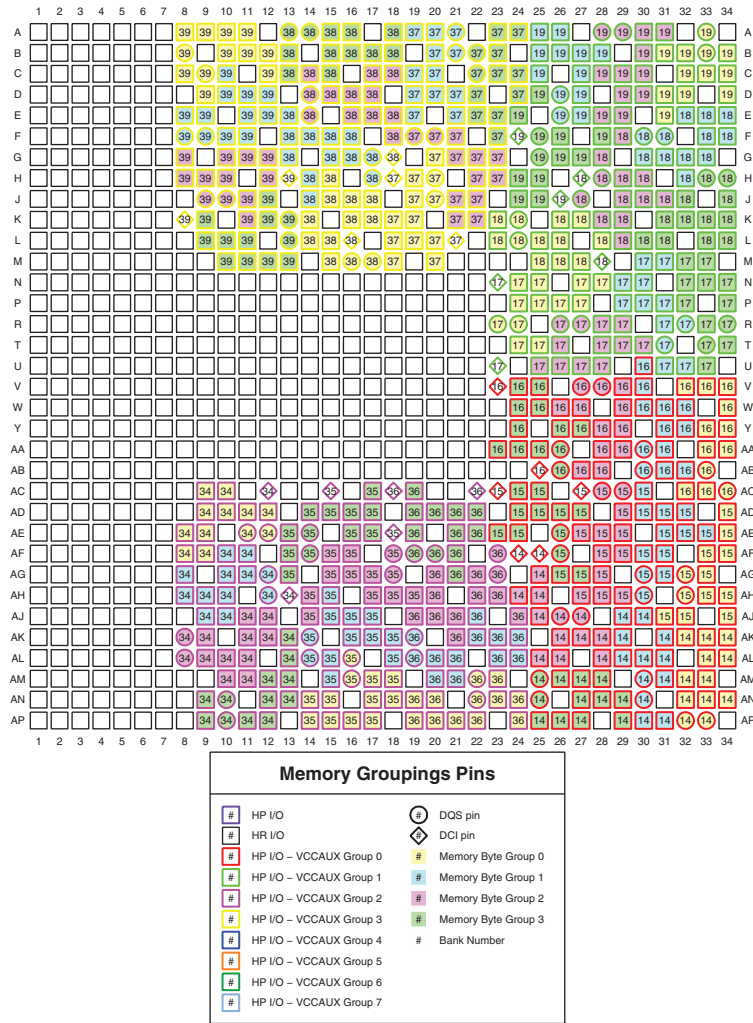

ug475\_c3\_087\_122811

Figure 3-71: FF/FFG1157 and RF1157 Packages—7V585T Memory Groupings

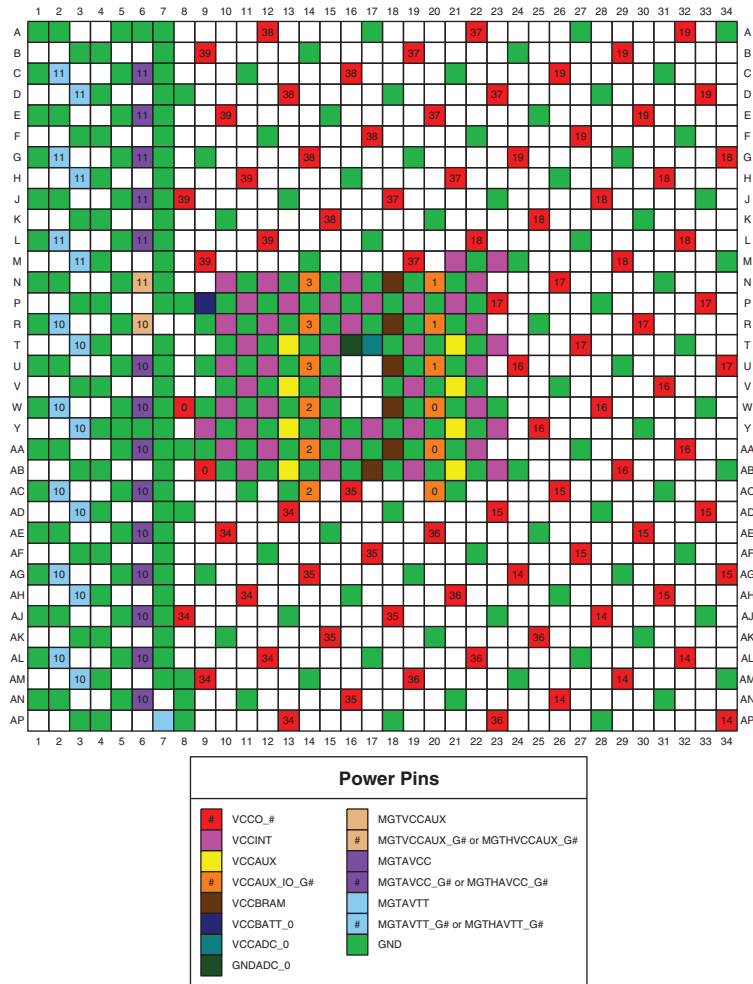

ug475\_c3\_088\_122811

Figure 3-72: FF/FG1157 and RF1157 Packages—7V585T Power and GND Placement

## FF/FFG1761 and RF1761 Packages—7V585T

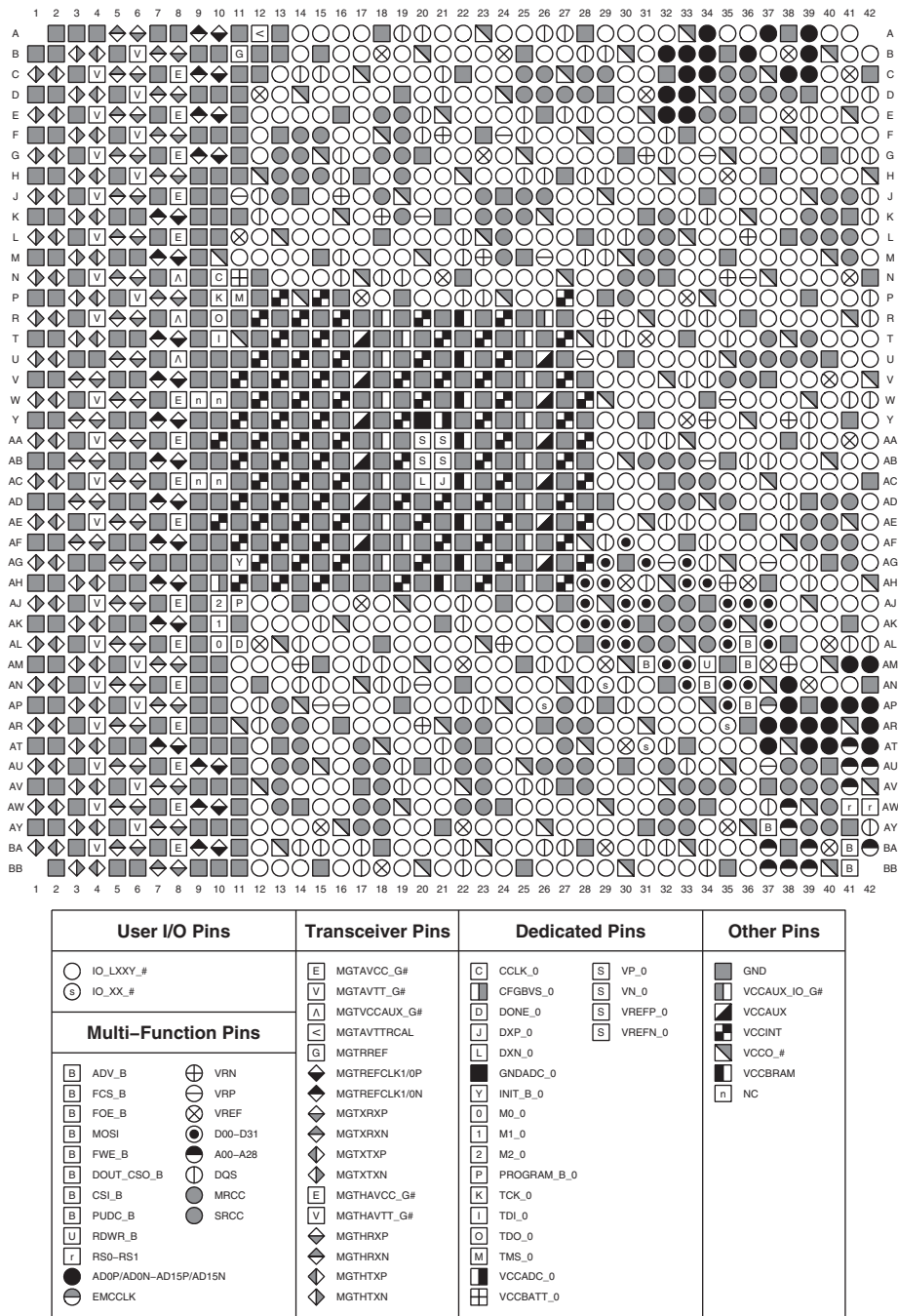

ug475\_c3\_089\_070512

Figure 3-73: FF/FFG1761 and RF1761 Packages—7V585T Pinout Diagram

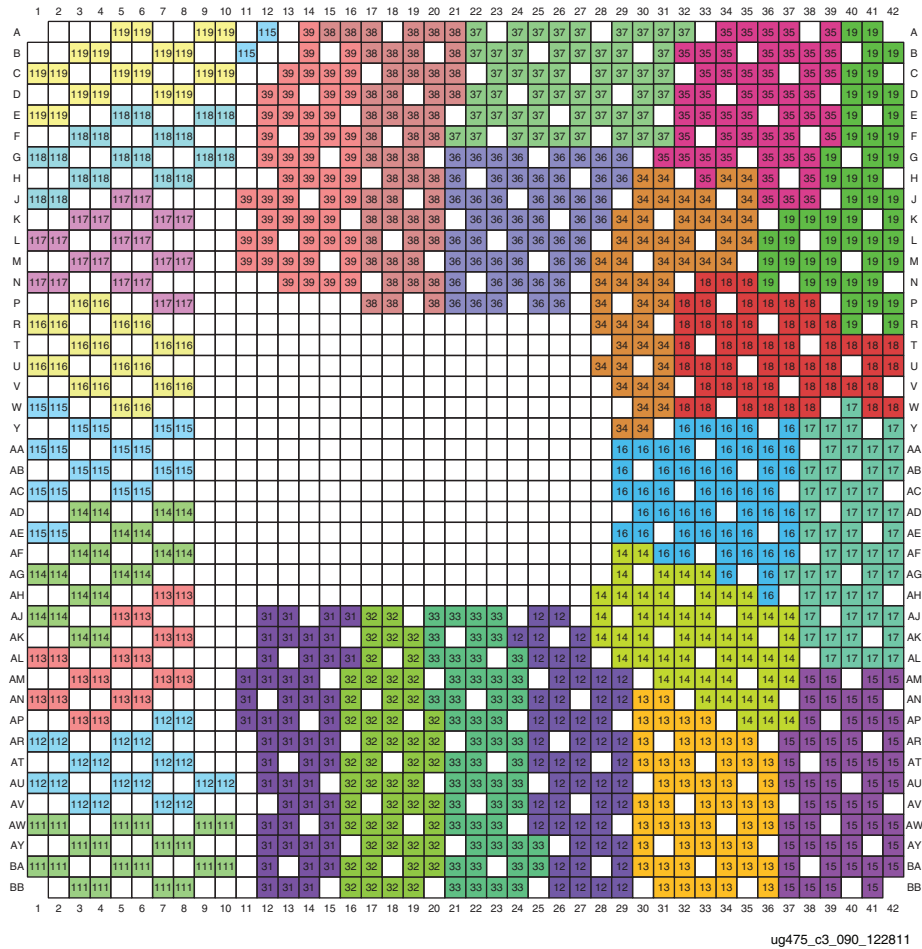
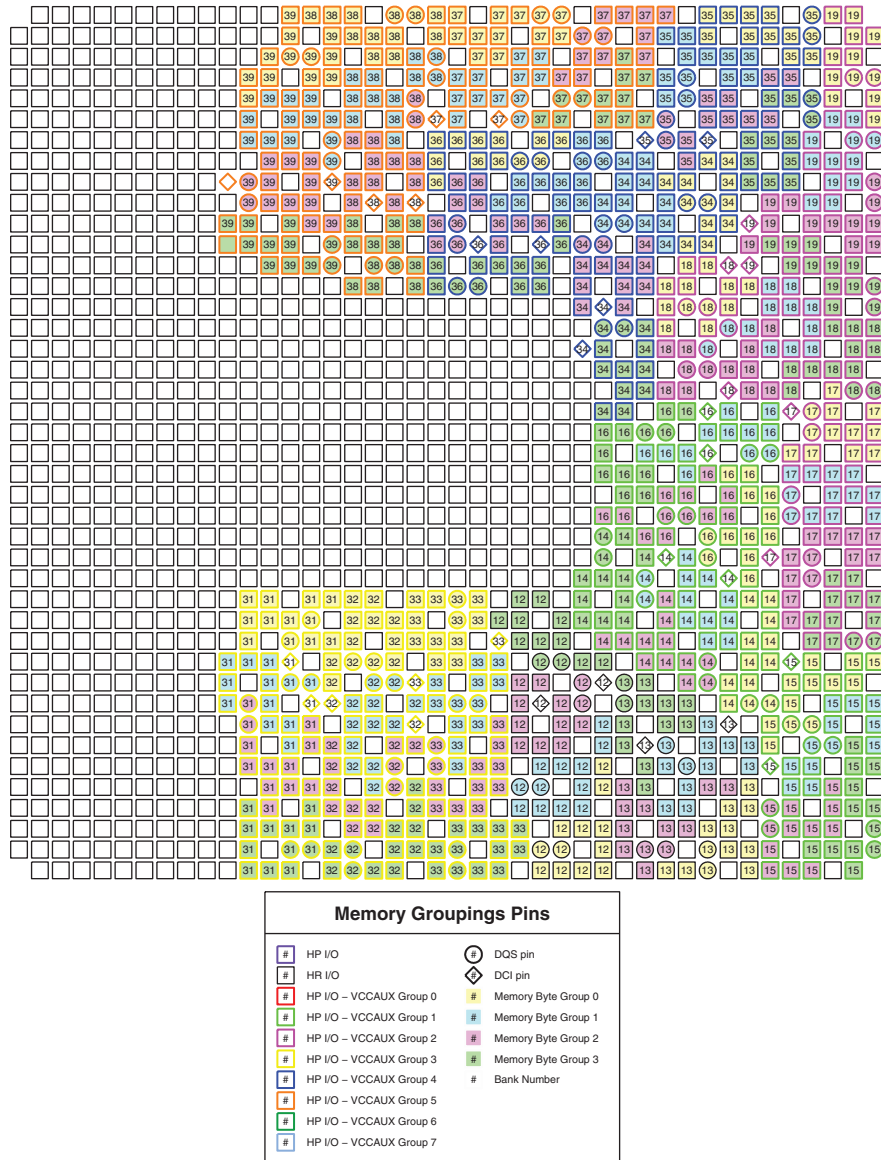

Figure 3-74: FF/FG1761 and RF1761 Packages—7V585T I/O Banks





ug475\_c3\_091\_122811

Figure 3-75: FF/FFG1761 and RF1761 Packages—7V585T Memory Groupings

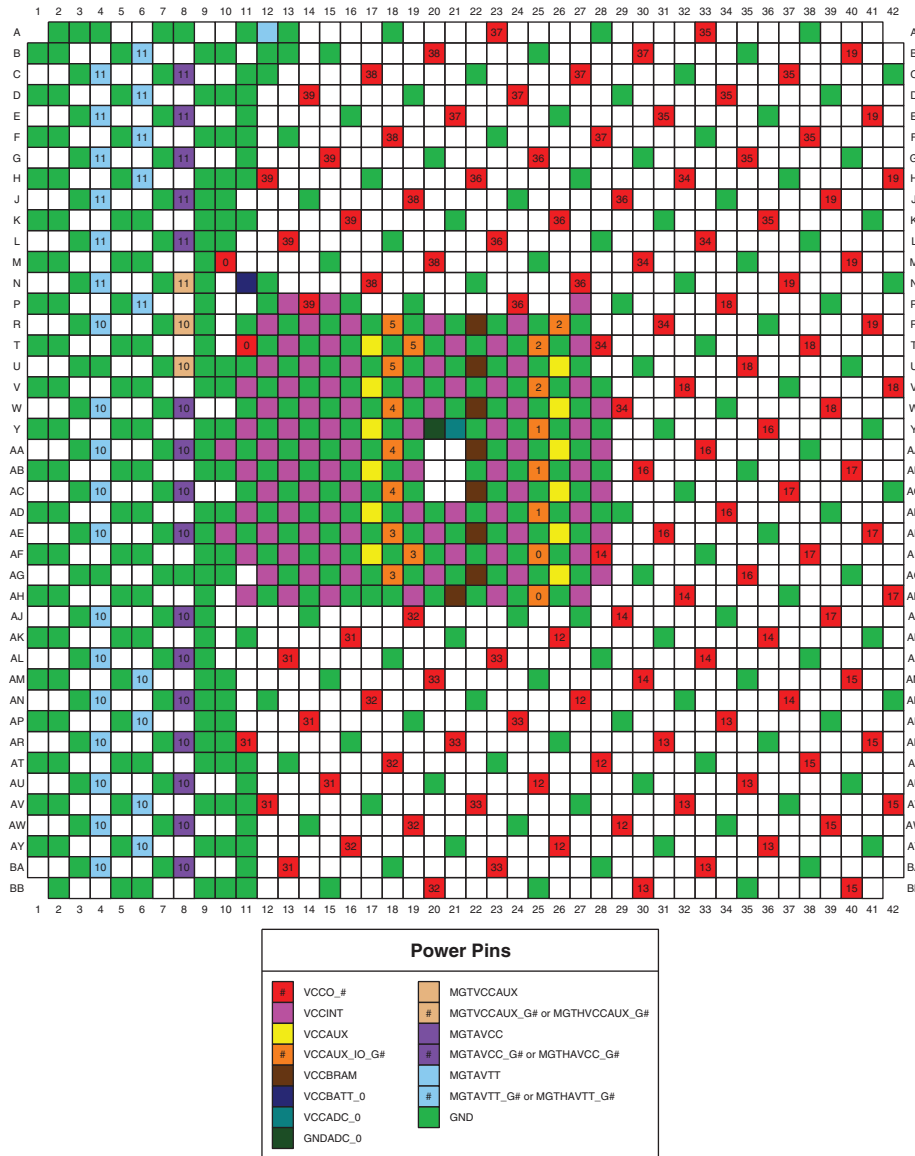

ug475\_c3\_092\_070512

Figure 3-76: FF/FG1761 and RF1761 Packages—7V585T Power and GND Placement

# FL/FLG1925 Packages—7V2000T

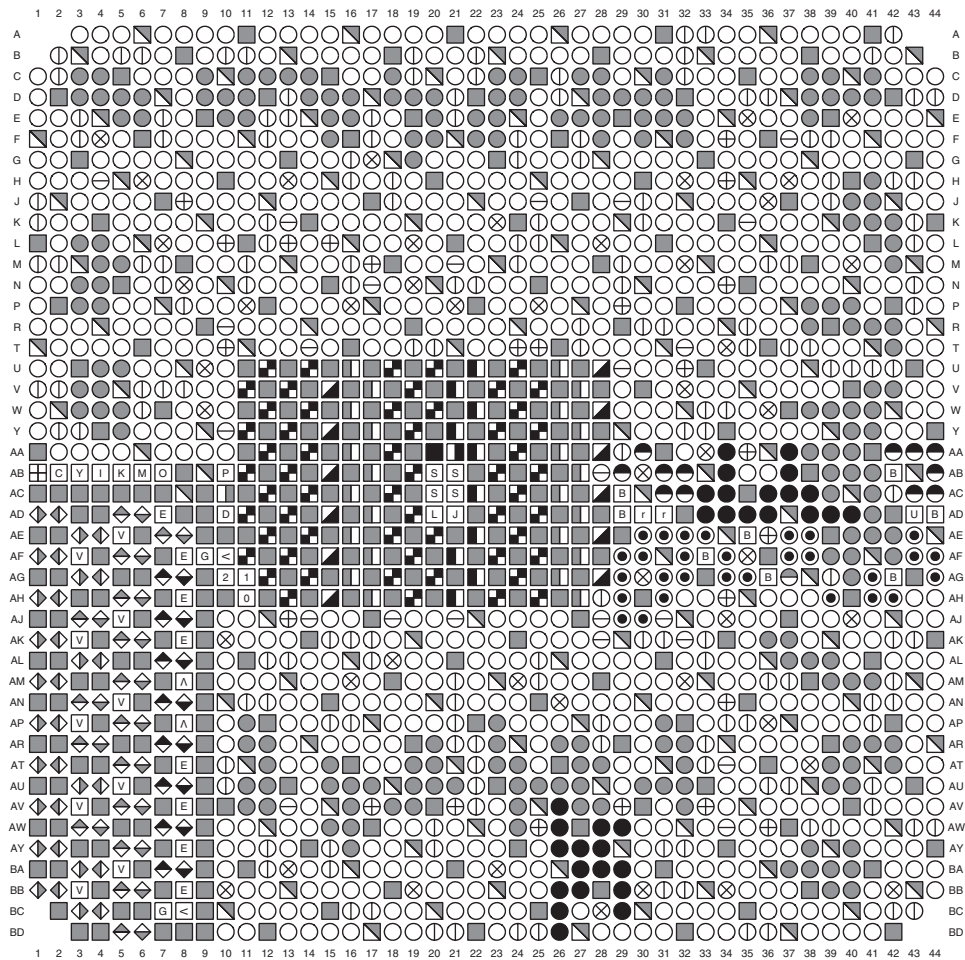

User I/O Pins	Transceiver Pins	Dedicated Pins	Other Pins
<ul style="list-style-type: none"> <li>○ IO_LXXY_#</li> <li>○ IO_XX_#</li> </ul>	<ul style="list-style-type: none"> <li>ⓔ MGTAVCC_G#</li> <li>Ⓥ MGTAVTT_G#</li> <li>ⓐ MGTVCCAUX_G#</li> <li>Ⓜ MGTAVTTRCAL</li> <li>ⓖ MGTREFREF</li> <li>Ⓢ MGTREFCLK1/0P</li> <li>Ⓢ MGTREFCLK1/0N</li> <li>Ⓢ MGTXRXP</li> <li>Ⓢ MGTXRXP</li> <li>Ⓢ MGTXTXP</li> <li>Ⓢ MGTXTXP</li> <li>ⓔ MGTAVVCC_G#</li> <li>Ⓥ MGTAVVTT_G#</li> <li>Ⓢ MGTTHRXP</li> <li>Ⓢ MGTTHRXP</li> <li>Ⓢ MGTHTXP</li> <li>Ⓢ MGTHTXP</li> </ul>	<ul style="list-style-type: none"> <li>ⓐ CCLK_0</li> <li>Ⓢ CFGBVS_0</li> <li>Ⓢ DONE_0</li> <li>Ⓢ DXP_0</li> <li>Ⓢ DXN_0</li> <li>Ⓢ GNDADC</li> <li>Ⓢ INIT_B_0</li> <li>Ⓢ M0_0</li> <li>Ⓢ M1_0</li> <li>Ⓢ M2_0</li> <li>Ⓢ PROGRAM_B_0</li> <li>Ⓢ TCK_0</li> <li>Ⓢ TDI_0</li> <li>Ⓢ TDO_0</li> <li>Ⓢ TMS_0</li> <li>Ⓢ VCCADC</li> <li>Ⓢ VCCBATT_0</li> </ul>	<ul style="list-style-type: none"> <li>Ⓢ GND</li> <li>Ⓢ VCCAUX_IO_G#</li> <li>Ⓢ VCCAUX</li> <li>Ⓢ VCCINT</li> <li>Ⓢ VCCO_#</li> <li>Ⓢ VCCBRAM</li> <li>Ⓢ NC</li> </ul>
<b>Multi-Function Pins</b>			
<ul style="list-style-type: none"> <li>Ⓢ ADV_B</li> <li>Ⓢ FCS_B</li> <li>Ⓢ FOE_B</li> <li>Ⓢ MOSI</li> <li>Ⓢ FWE_B</li> <li>Ⓢ DOUT_CSO_B</li> <li>Ⓢ CSI_B</li> <li>Ⓢ PUDC_B</li> <li>Ⓢ RDWR_B</li> <li>Ⓢ RSO-RS1</li> <li>Ⓢ ADOP/ADON-AD15P/AD15N</li> <li>Ⓢ EMCCLK</li> </ul>	<ul style="list-style-type: none"> <li>Ⓢ VRN</li> <li>Ⓢ VRP</li> <li>Ⓢ VREF</li> <li>Ⓢ D00-D31</li> <li>Ⓢ A00-A28</li> <li>Ⓢ DQS</li> <li>Ⓢ MRCC</li> <li>Ⓢ SRCC</li> </ul>		

ug475\_c3\_097\_101413

Figure 3-77: FL/FLG1925 Packages—7V2000T Pinout Diagram

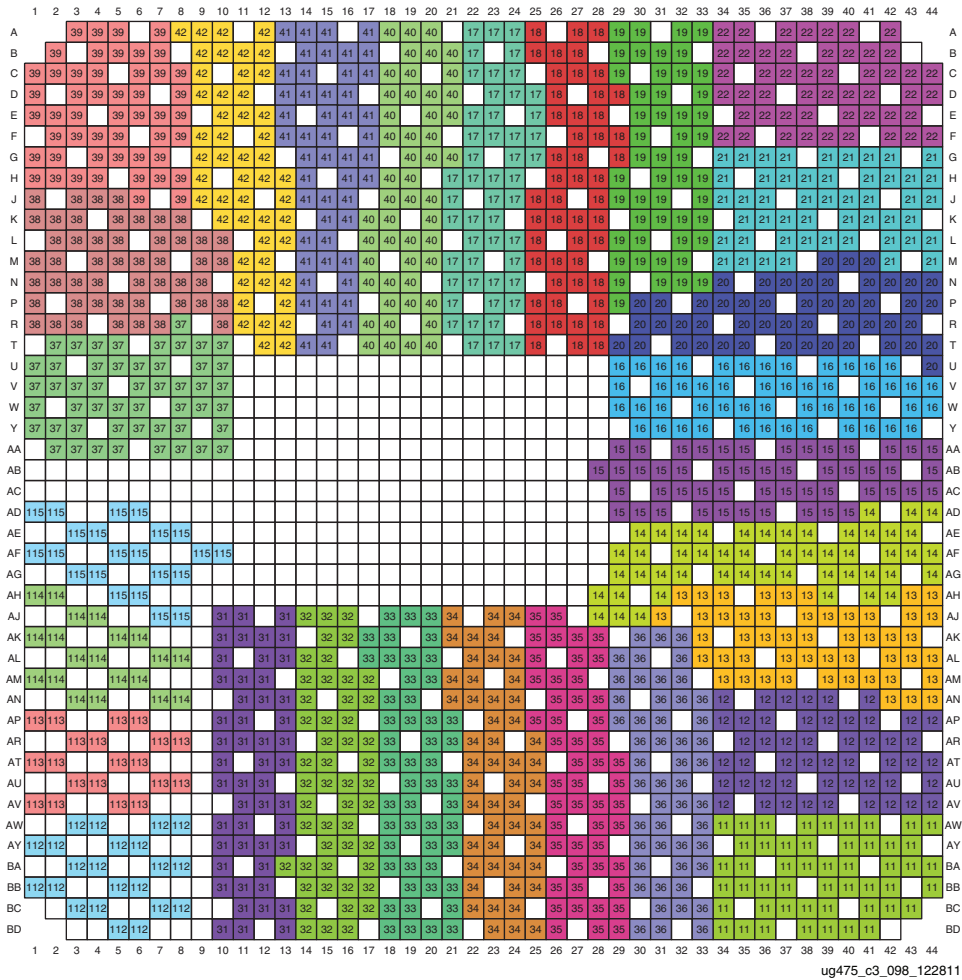

Figure 3-78: FL/FLG1925 Packages—7V2000T I/O Banks

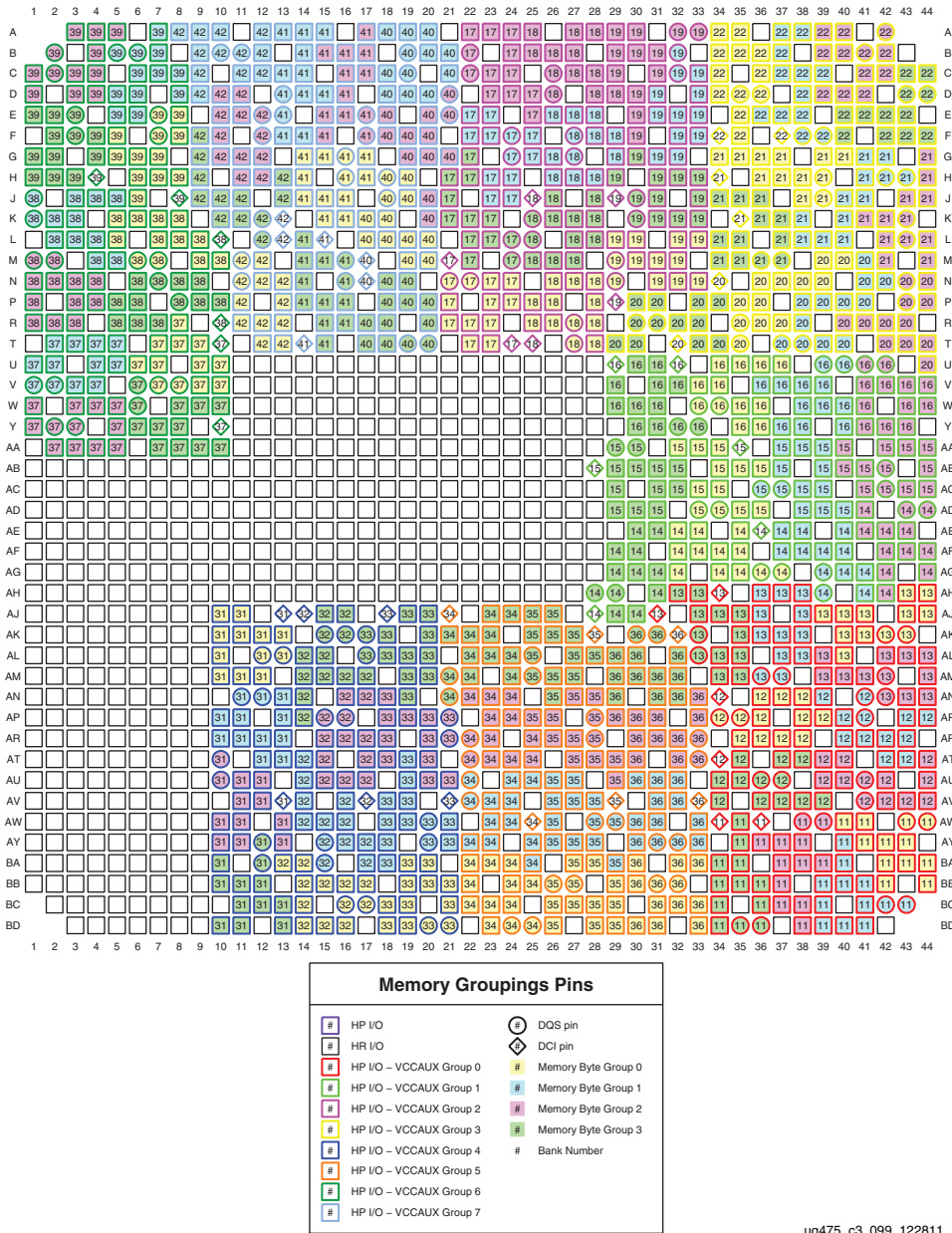
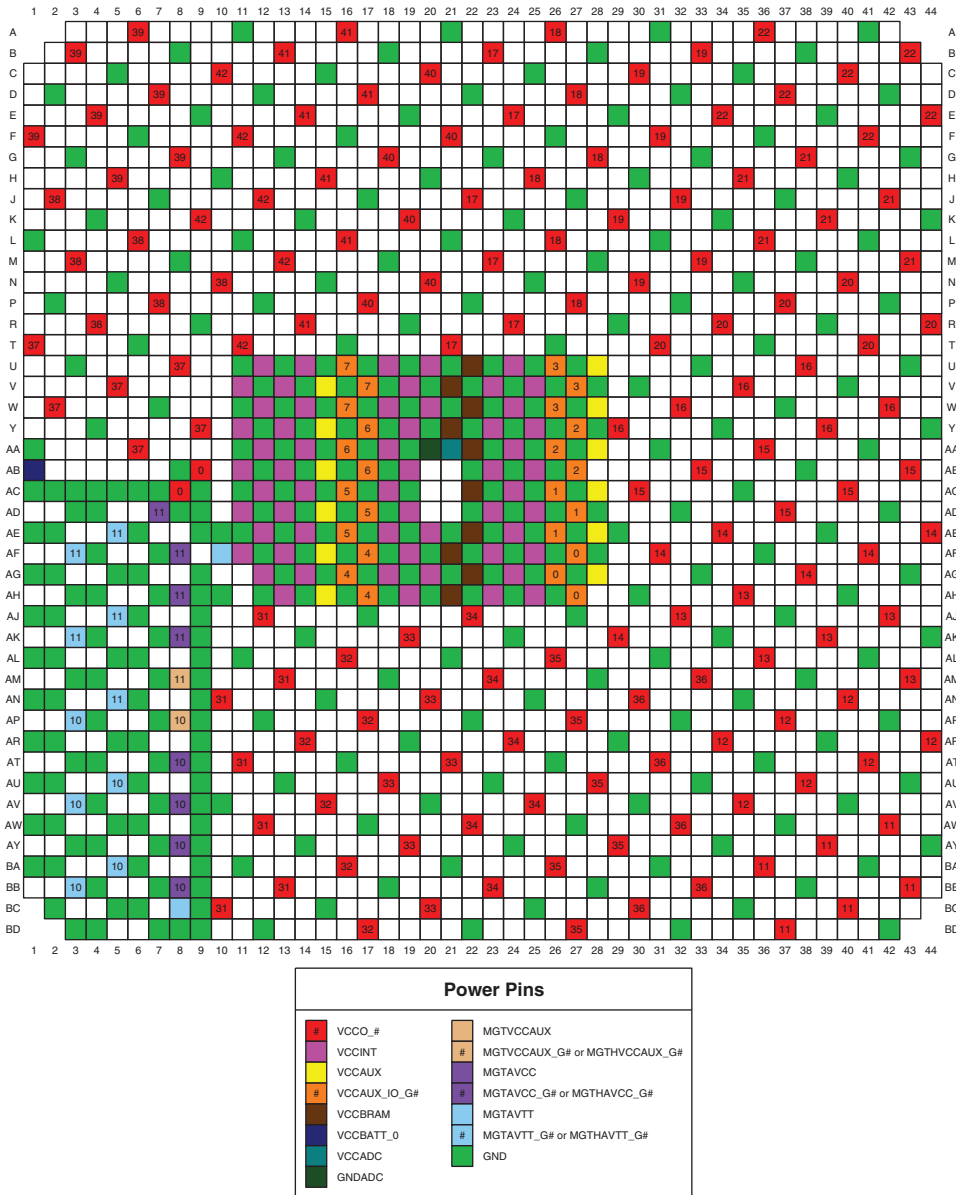

Figure 3-79: FL/FLG1925 Packages—7V2000T Memory Groupings



ug475\_c3\_100\_101413

Figure 3-80: FL/FLG1925 Packages—7V2000T Power and GND Placement

### FH/FHG1761 Packages—7V2000T

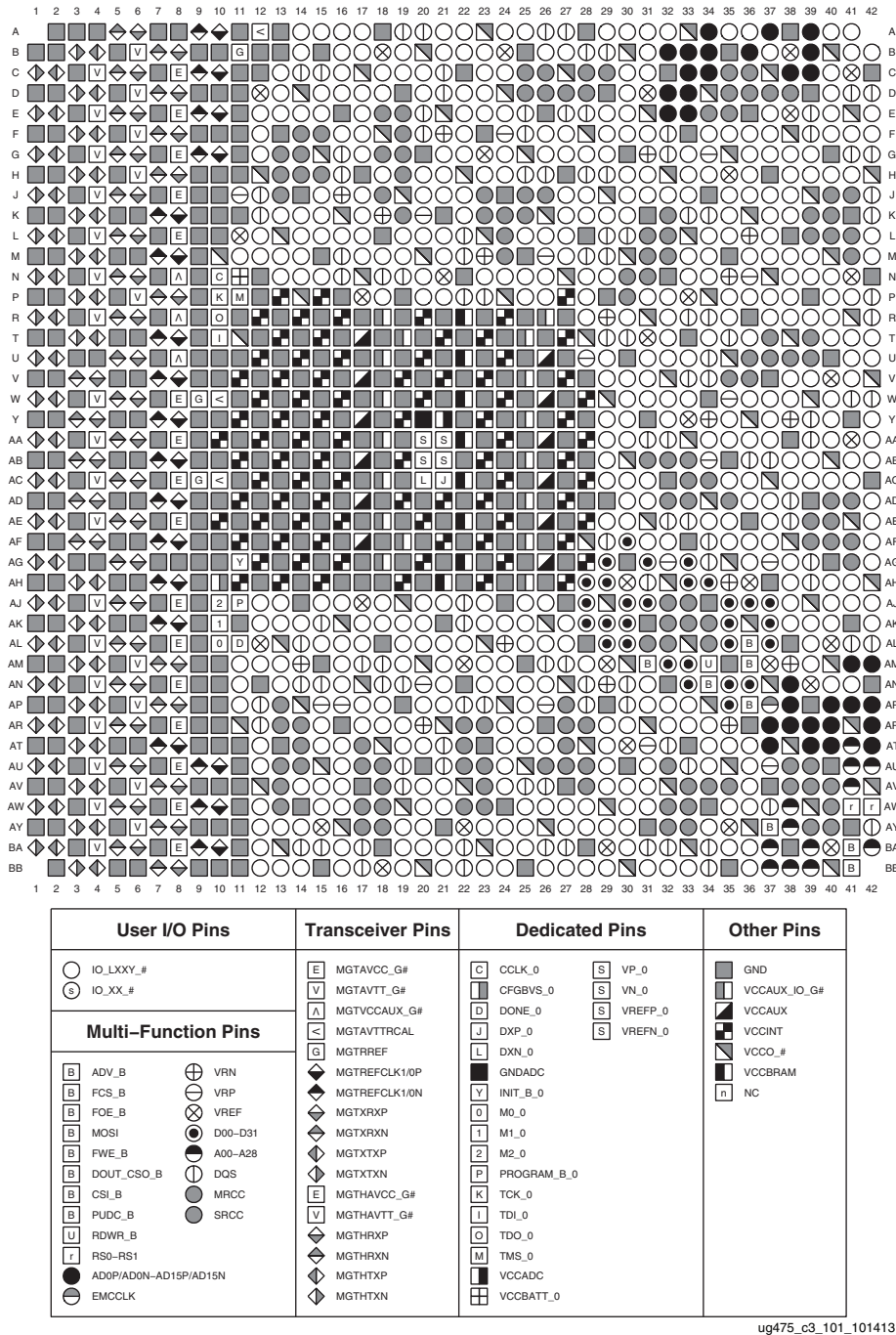

Figure 3-81: FH/FHG1761 Packages—7V2000T Pinout Diagram

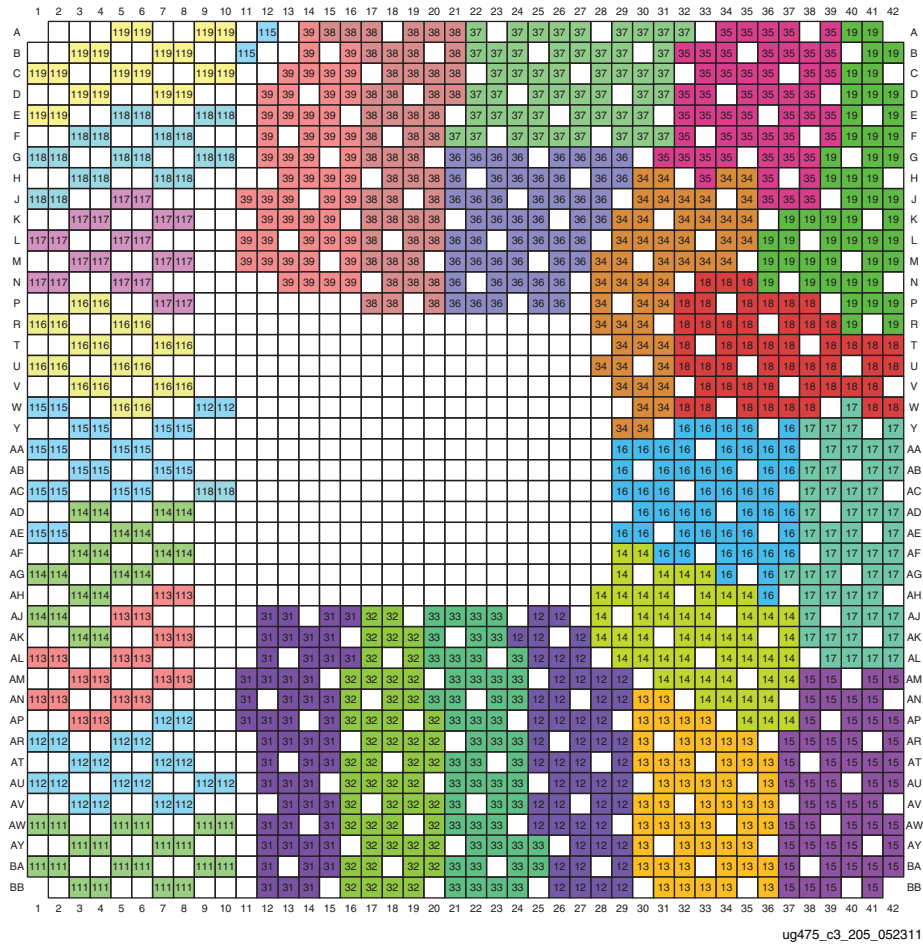
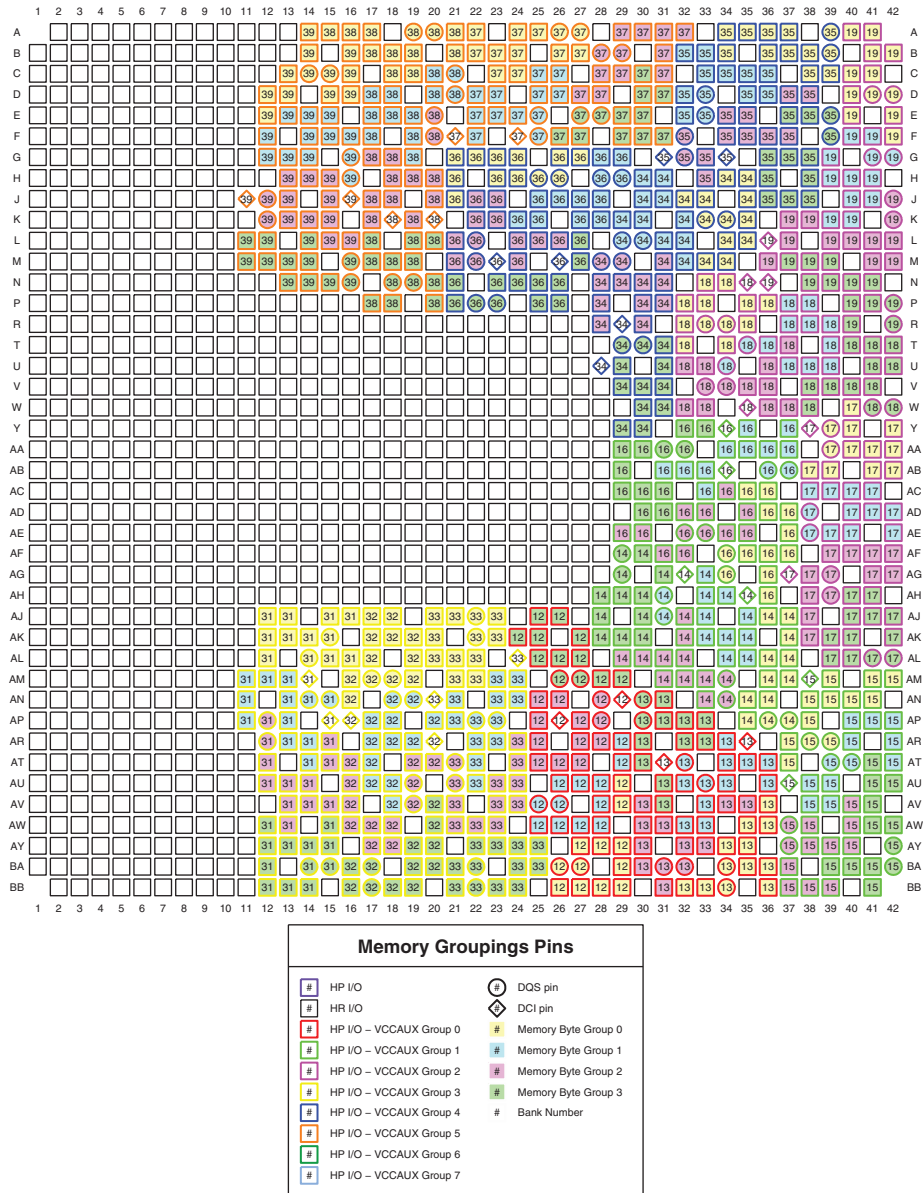

Figure 3-82: FH/FHG1761 Packages—7V2000T I/O Banks





ug475\_c3\_206\_052311

Figure 3-83: FH/FHG1761 Packages—7V2000T Memory Groupings

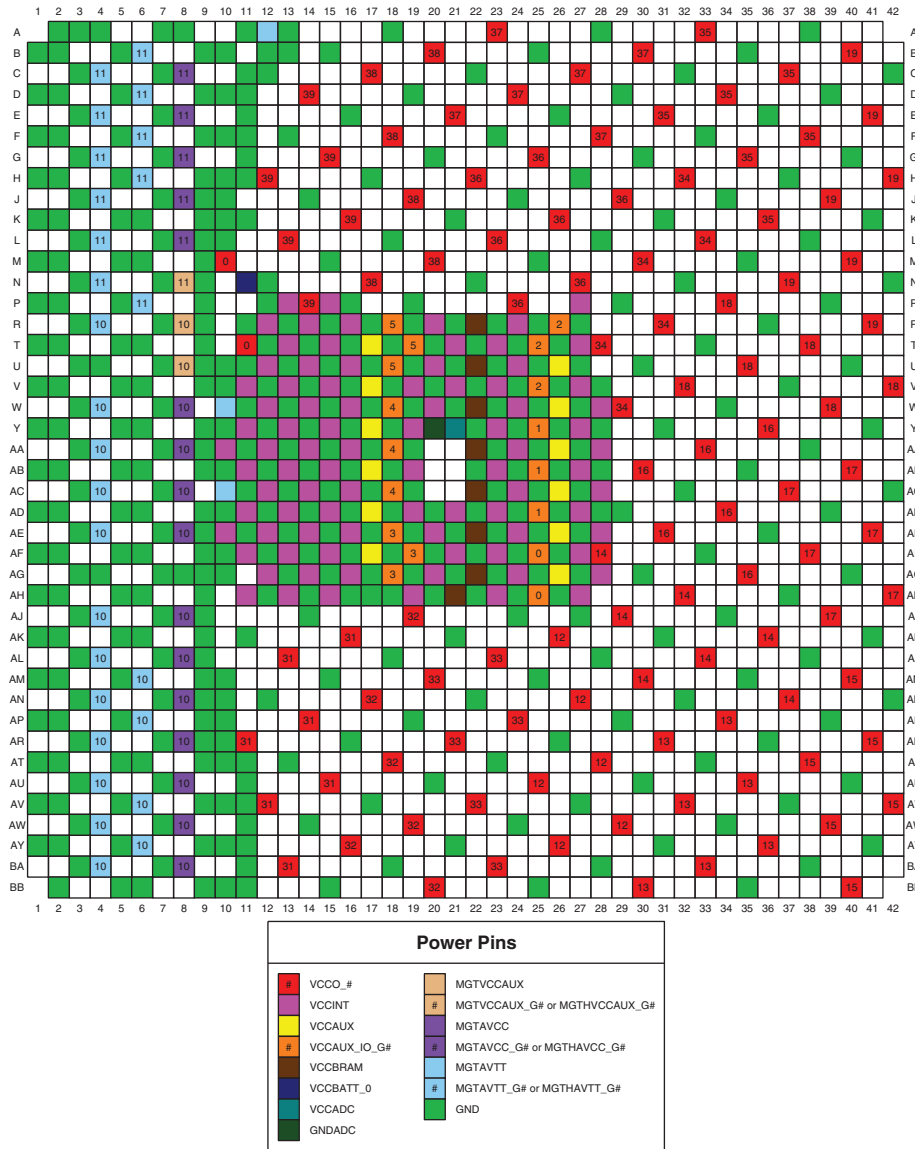

ug475\_c3\_104\_101413

Figure 3-84: FH/FHG1761 Packages—7V2000T Power and GND Placement

# FF/FFG1157 and RF1157 Packages—7VX330T, 7VX415T, and 7VX690T

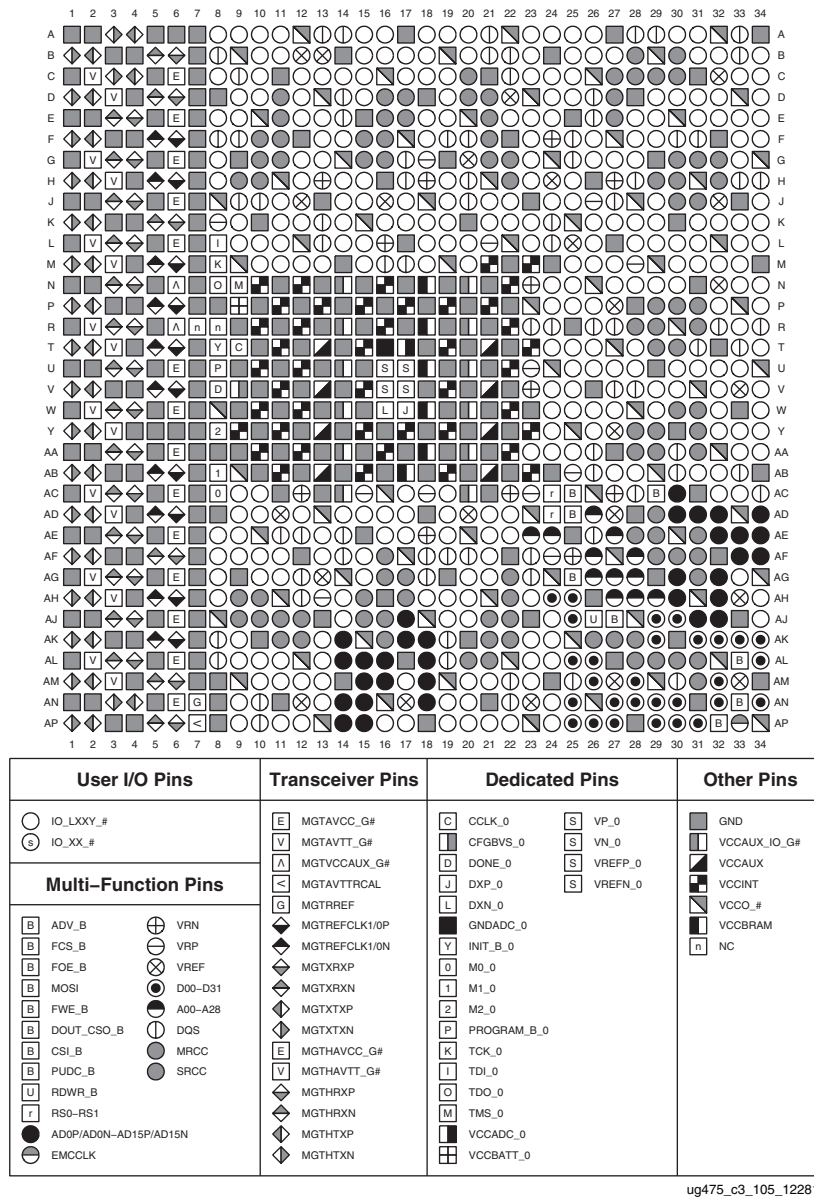

Figure 3-85: FF/FFG1157 and RF1157 Packages—7VX330T, 7VX415T, and 7VX690T Pinout Diagram

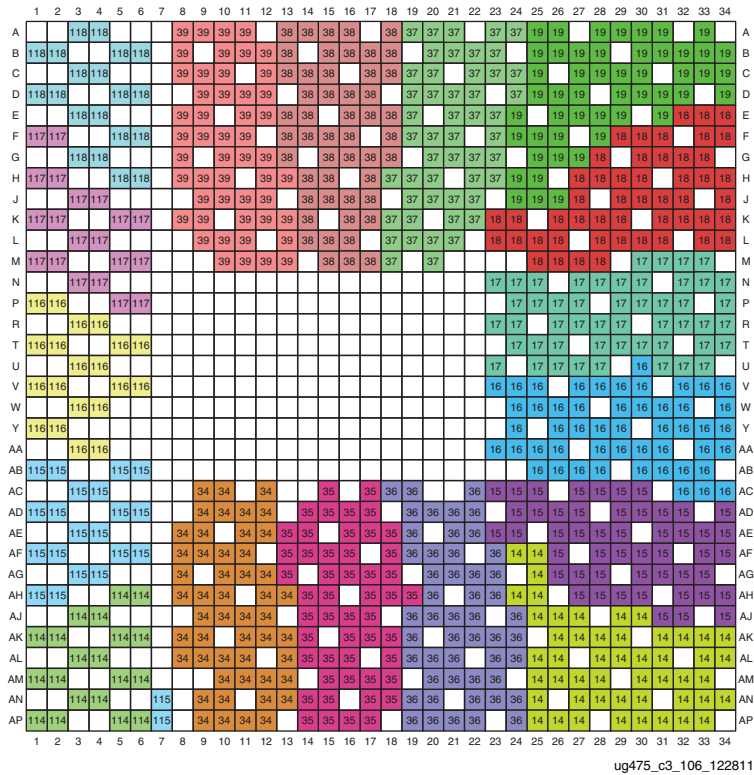
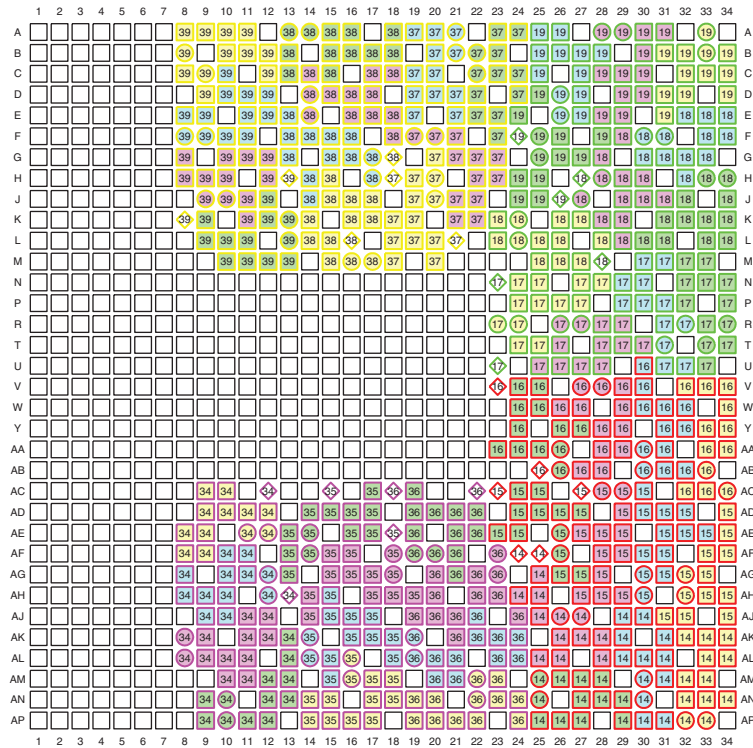

Figure 3-86: FF/FFG1157 and RF1157 Packages—7VX330T, 7VX415T, and 7VX690T I/O Banks



Memory Groupings Pins			
#	HP I/O	⊕	DQS pin
#	HR I/O	⊖	DCI pin
#	HP I/O - VCCAUX Group 0	#	Memory Byte Group 0
#	HP I/O - VCCAUX Group 1	#	Memory Byte Group 1
#	HP I/O - VCCAUX Group 2	#	Memory Byte Group 2
#	HP I/O - VCCAUX Group 3	#	Memory Byte Group 3
#	HP I/O - VCCAUX Group 4	#	Bank Number
#	HP I/O - VCCAUX Group 5		
#	HP I/O - VCCAUX Group 6		
#	HP I/O - VCCAUX Group 7		

ug475\_c3\_107\_122811

Figure 3-87: FF/FFG1157 and RF1157 Packages—7VX330T, 7VX415T, and 7VX690T Memory Groupings

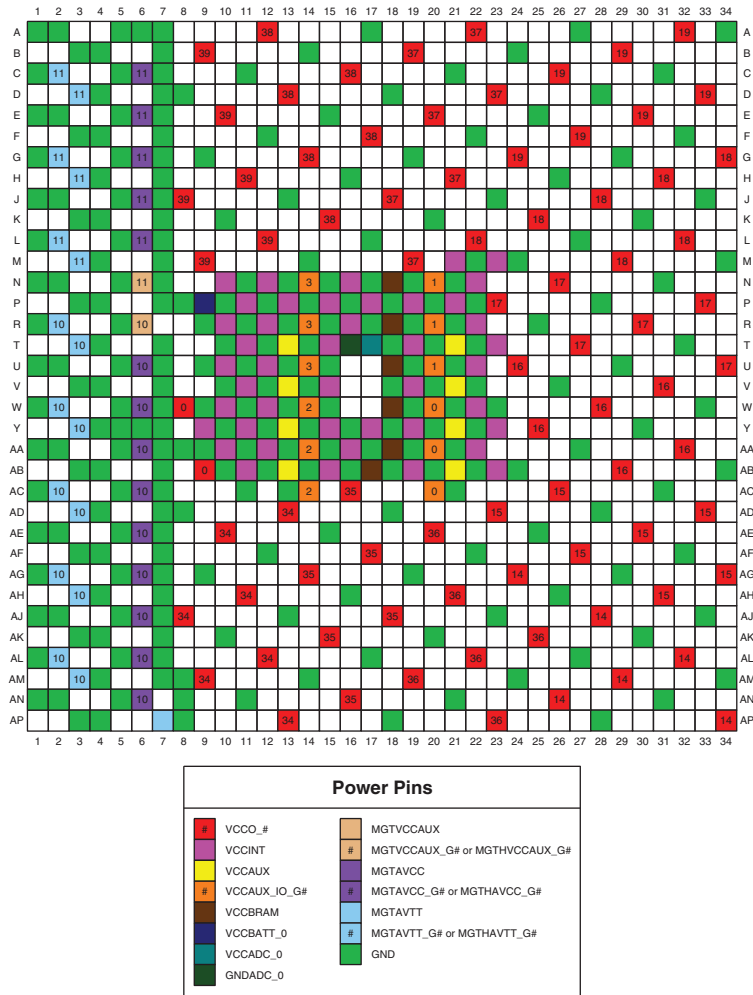

ug475\_c3\_108\_122811

Figure 3-88: FF/FG1157 and RF1157 Packages—7VX330T, 7VX415T, and 7VX690T Power and GND Placement

## FF/FFG1761 and RF1761 Packages—7VX330T

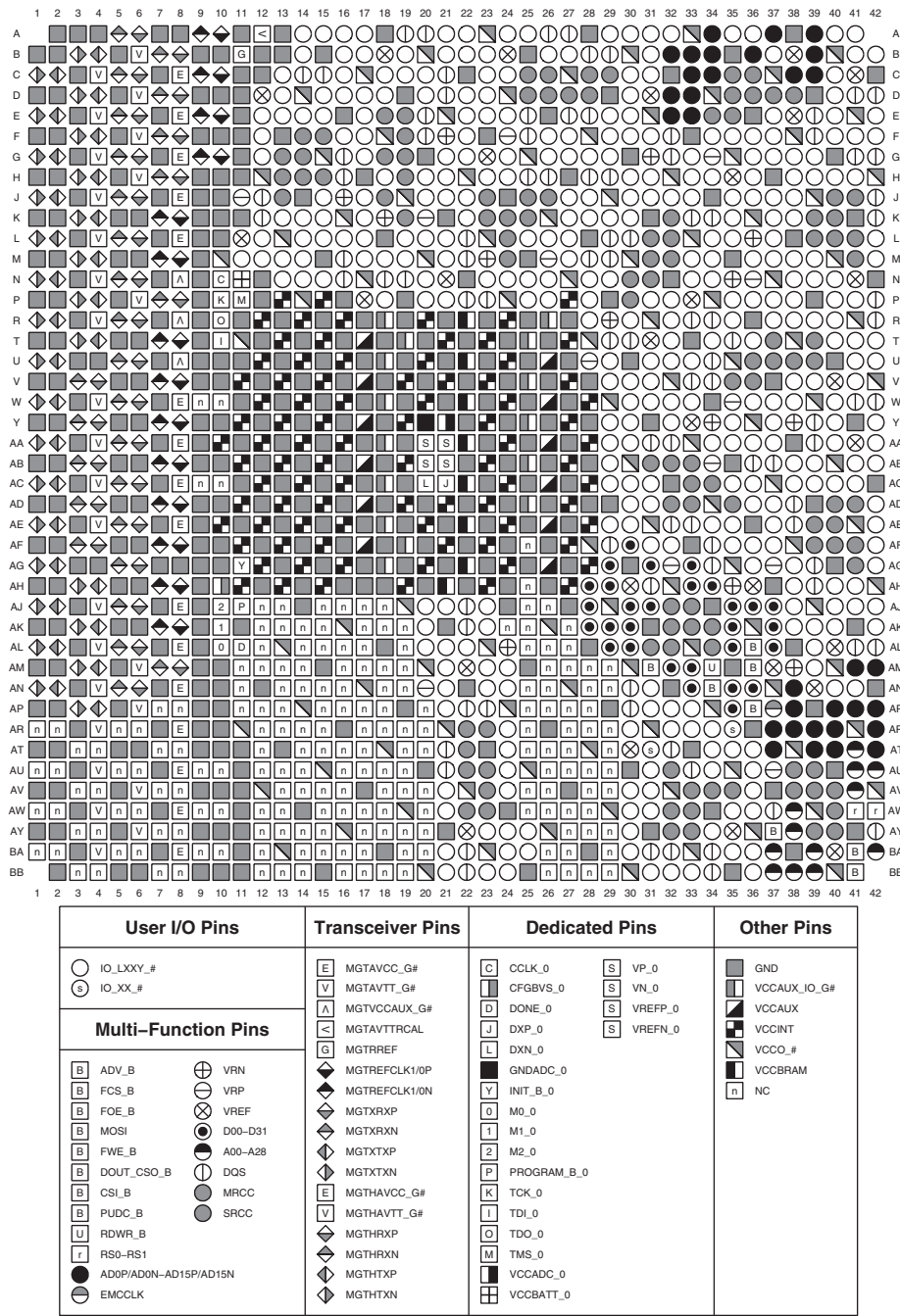

ug475\_c3\_109\_122811

Figure 3-89: FF/FFG1761 and RF1761 Packages—7VX330T Pinout Diagram

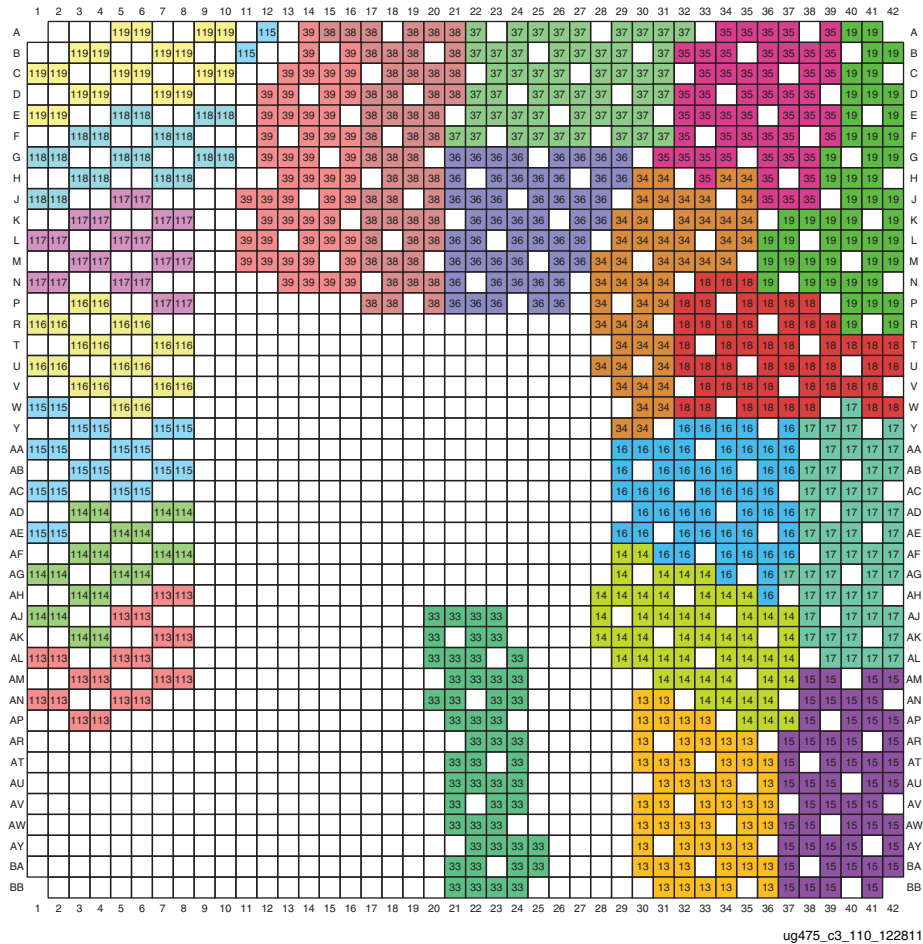
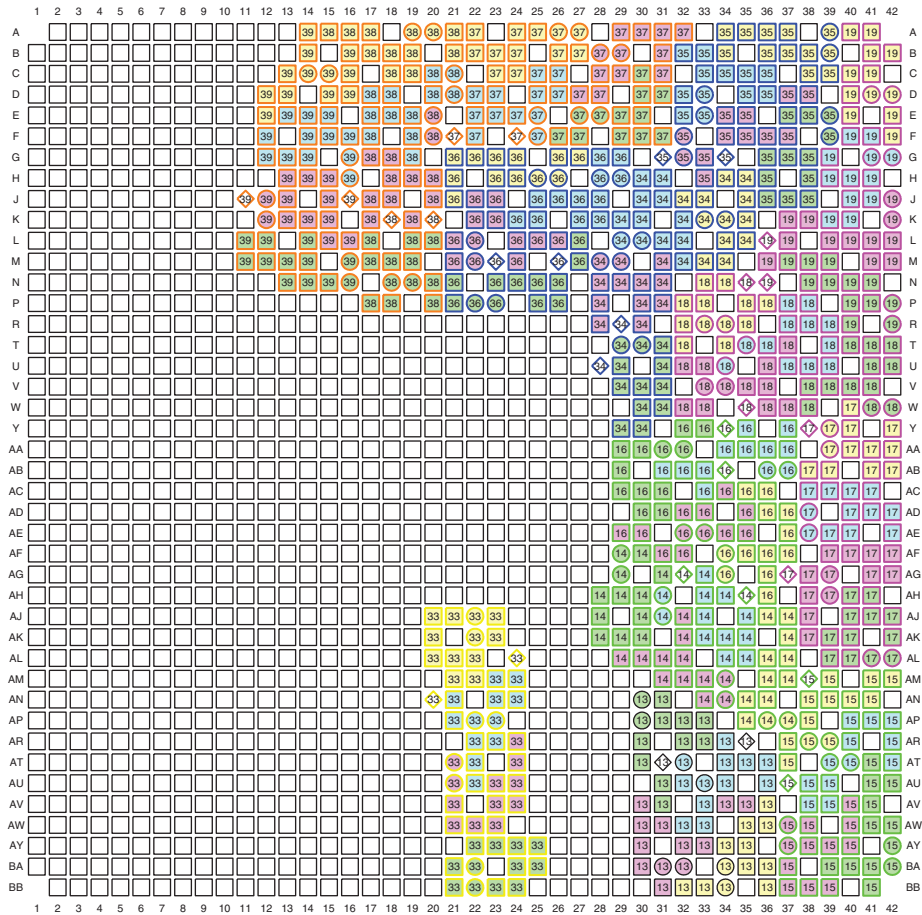

Figure 3-90: FF/FFG1761 and RF1761 Packages—7VX330T I/O Banks





Memory Groupings Pins			
#	HP I/O	⊕	DQS pin
#	HR I/O	⊕	DCI pin
#	HP I/O - VCCAUX Group 0	#	Memory Byte Group 0
#	HP I/O - VCCAUX Group 1	#	Memory Byte Group 1
#	HP I/O - VCCAUX Group 2	#	Memory Byte Group 2
#	HP I/O - VCCAUX Group 3	#	Memory Byte Group 3
#	HP I/O - VCCAUX Group 4	#	Bank Number
#	HP I/O - VCCAUX Group 5		
#	HP I/O - VCCAUX Group 6		
#	HP I/O - VCCAUX Group 7		

ug475\_c3\_111\_122811

Figure 3-91: FF/FFG1761 and RF1761 Packages—7VX330T Memory Groupings

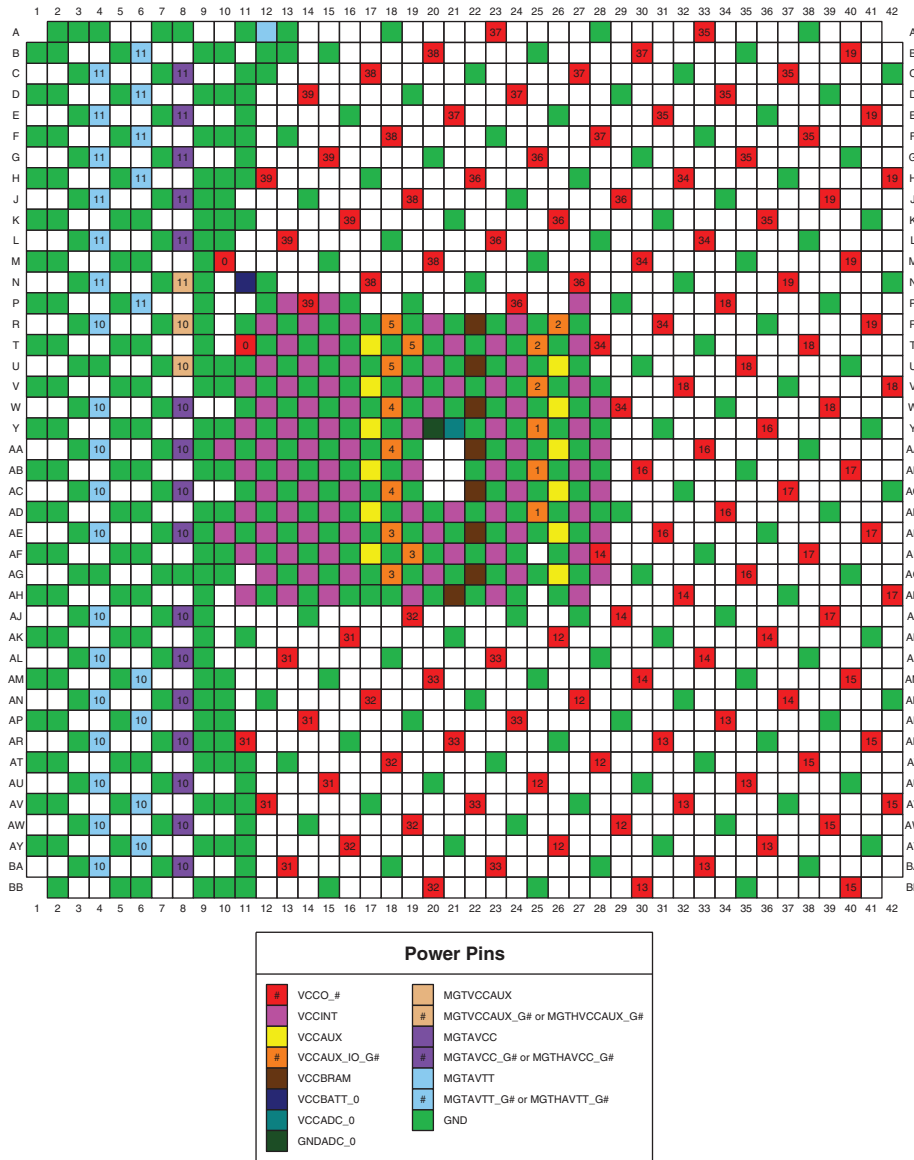

ug475\_c3\_112\_122811

Figure 3-92: FF/FFG1761 and RF1761 Packages—7VX330T Power and GND Placement

## FF/FFG1158 Packages—7VX415T, 7VX550T, and 7VX690T

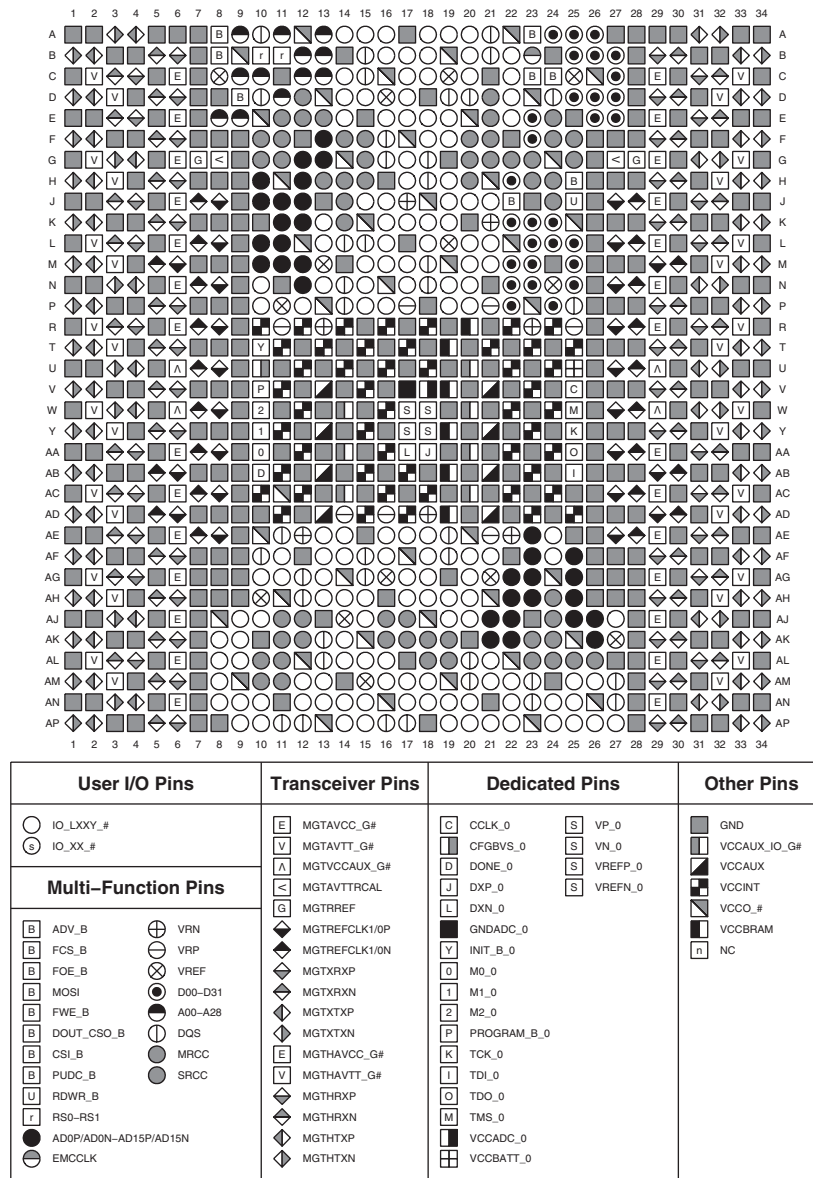

ug475\_c3\_113\_122811

Figure 3-93: FF/FFG1158 Packages—7VX415T, 7VX550T, and 7VX690T Pinout Diagram

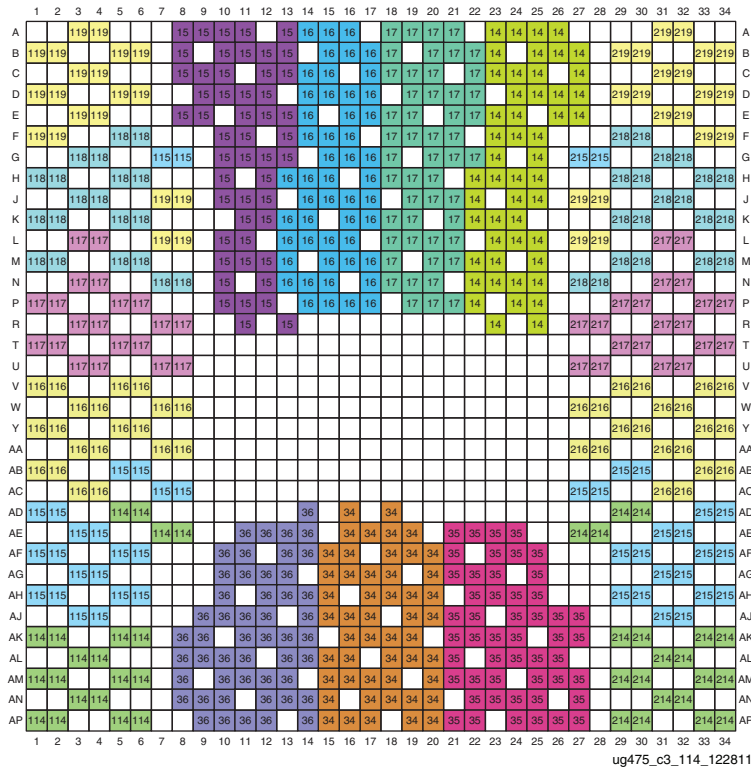
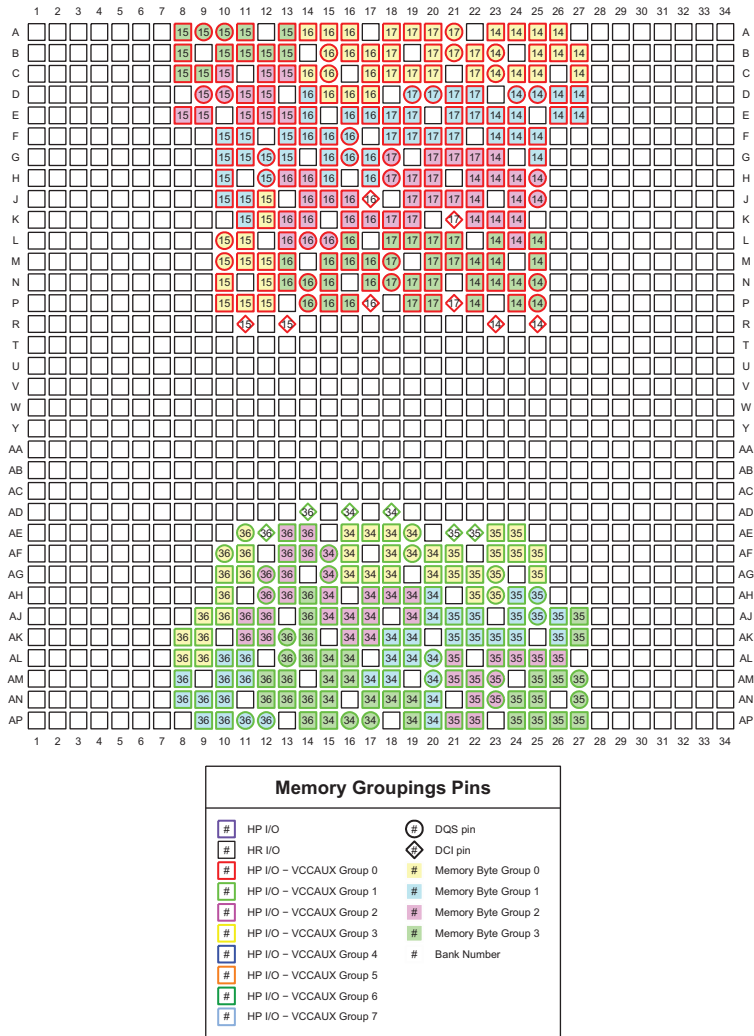
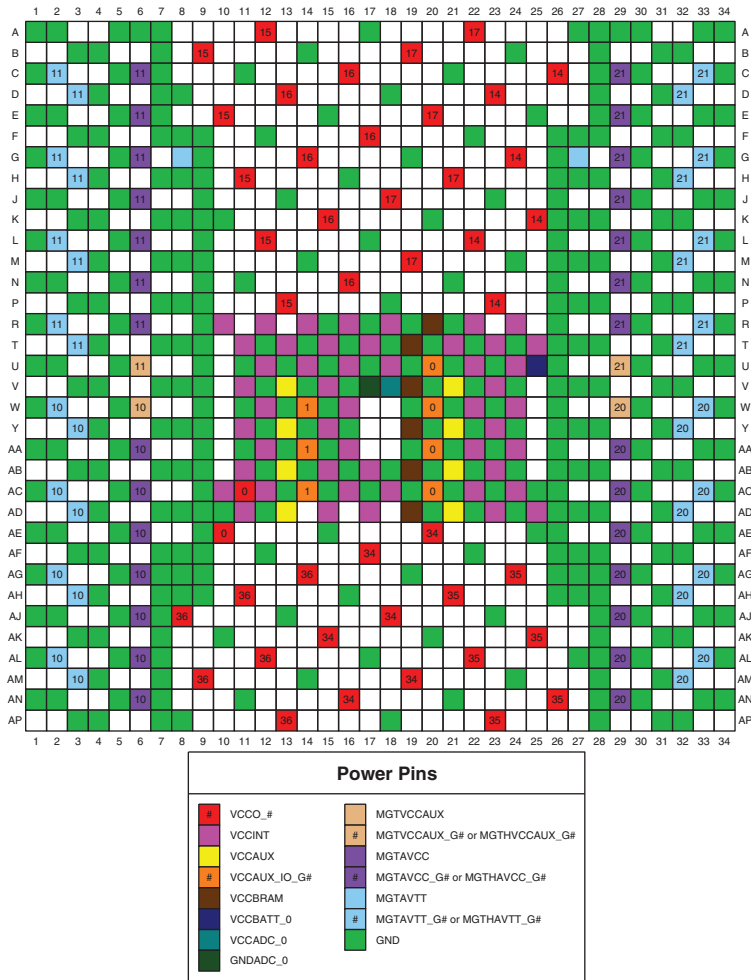

Figure 3-94: FF/FFG1158 Packages—7VX415T, 7VX550T, and 7VX690T I/O Banks



ug475\_c3\_115\_122811

Figure 3-95: FF/FFG1158 Packages—7VX415T, 7VX550T, and 7VX690T Memory Groupings



ug475\_c3\_116\_122811

Figure 3-96: FF/FFG1158 Packages—7VX415T, 7VX550T, and 7VX690T Power and GND Placement

# FF/FFG1927 Packages—7VX415T

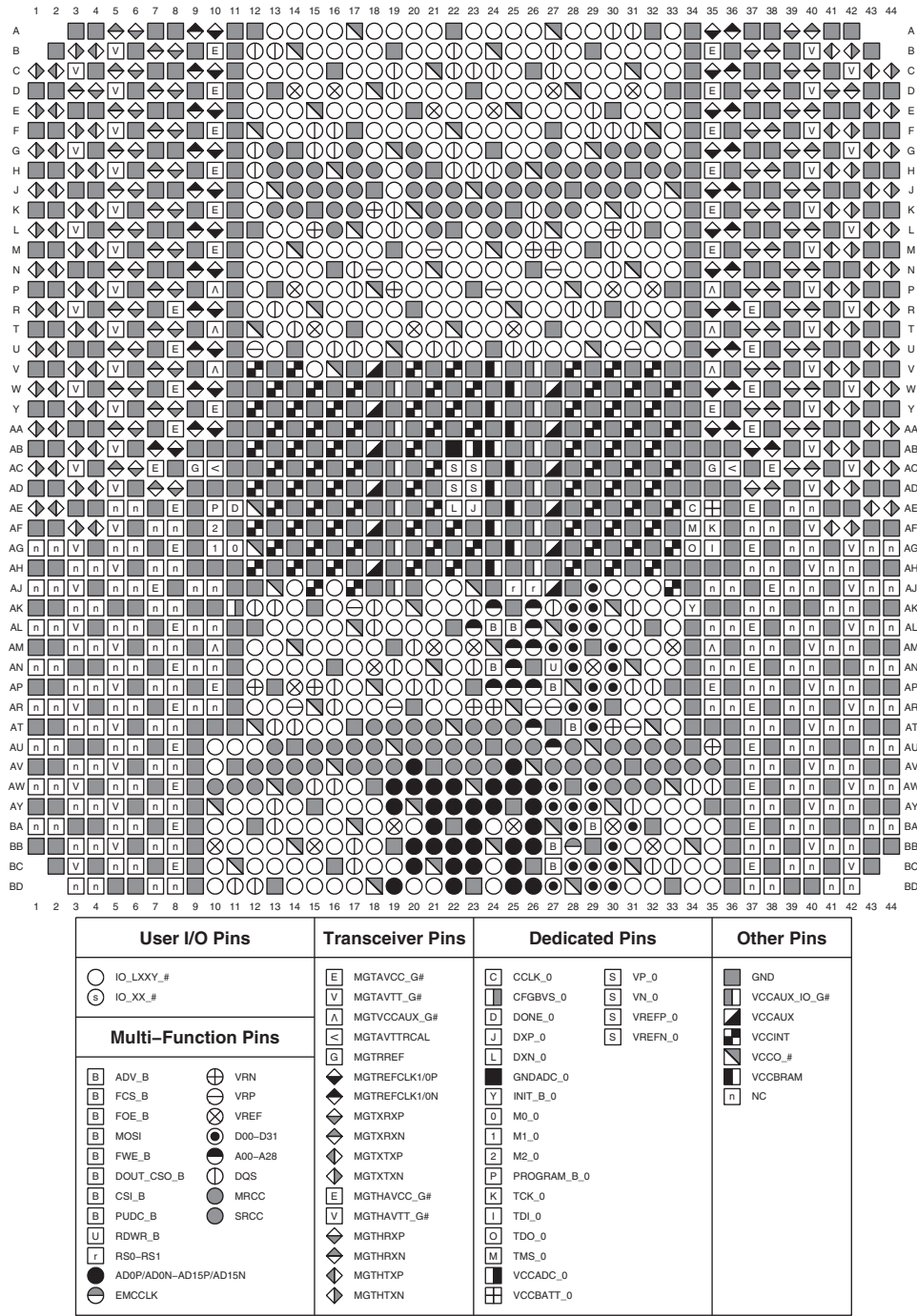

Figure 3-97: FF/FFG1927 Packages—7VX415T Pinout Diagram

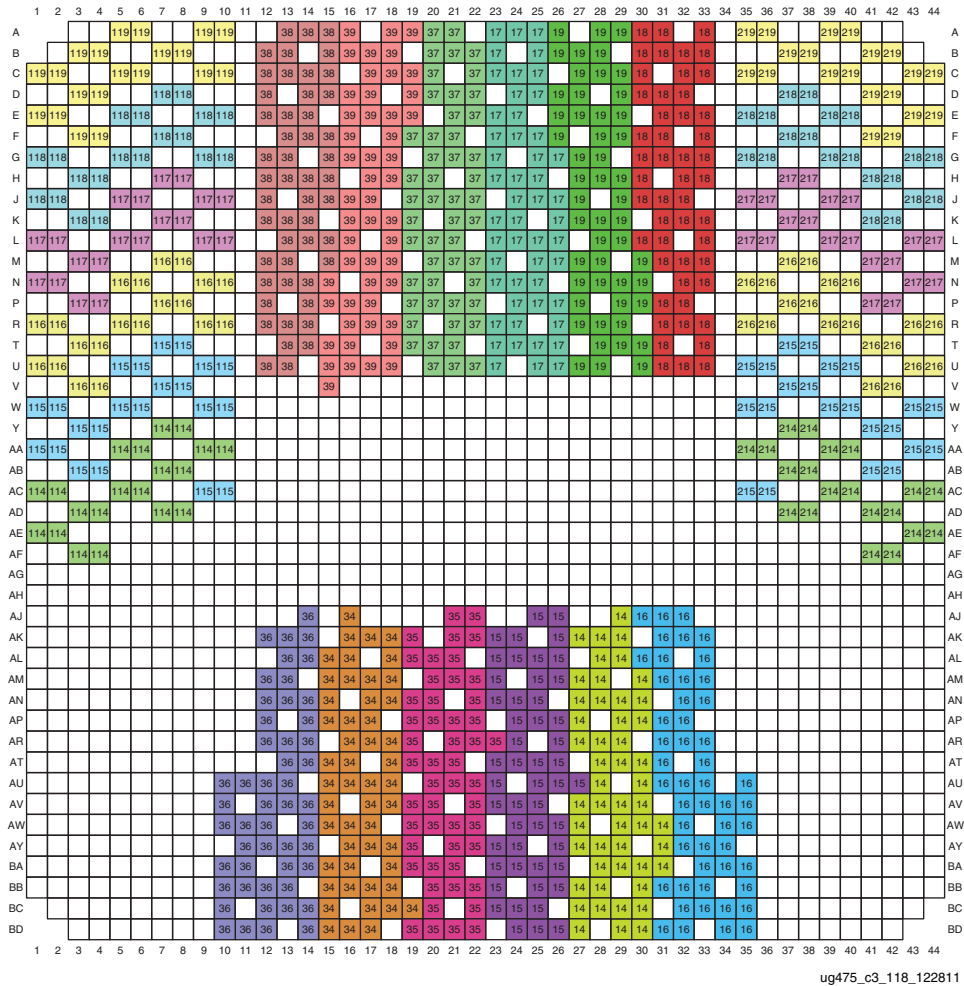

Figure 3-98: FF/FFG192T Packages—7VX415T I/O Banks



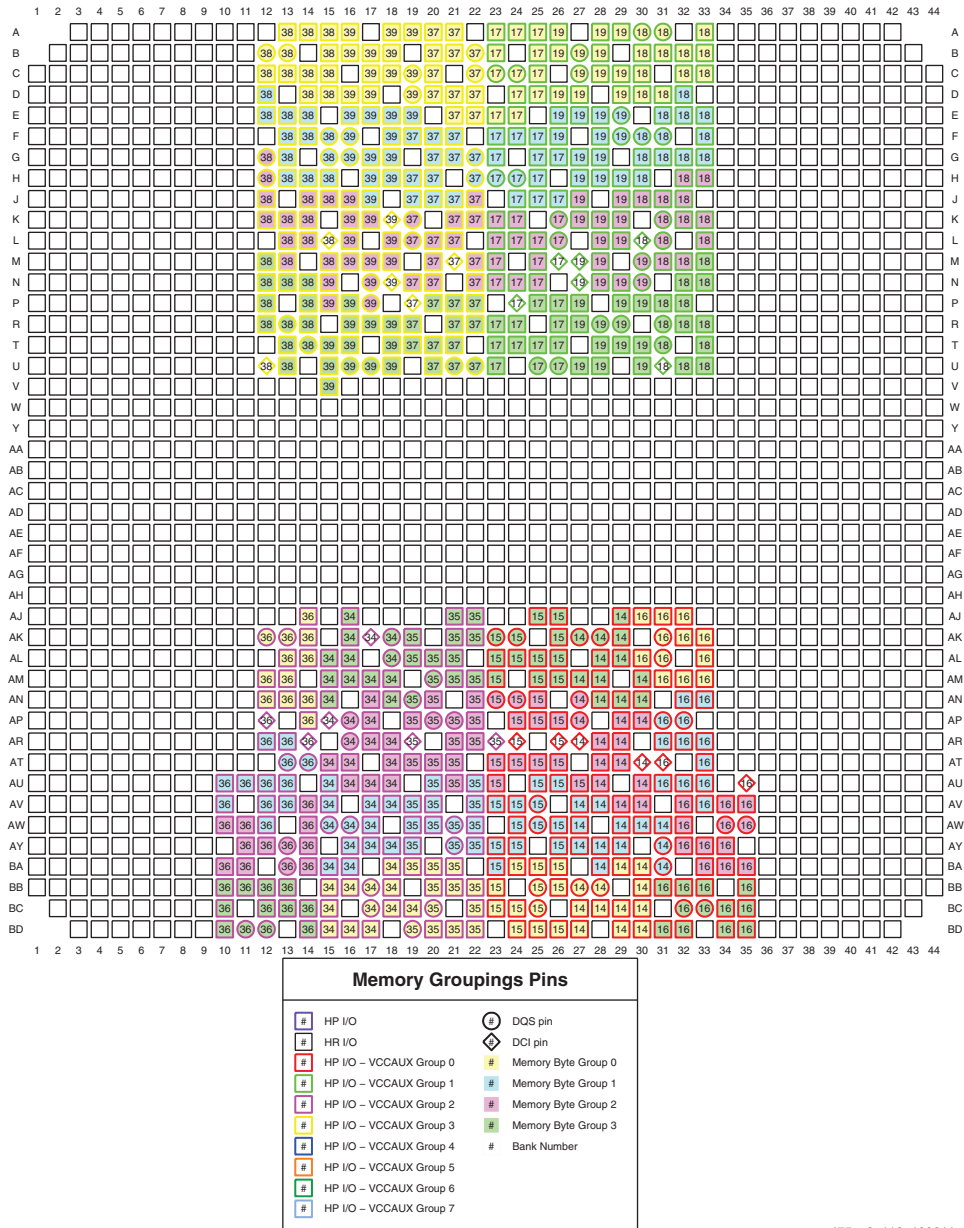
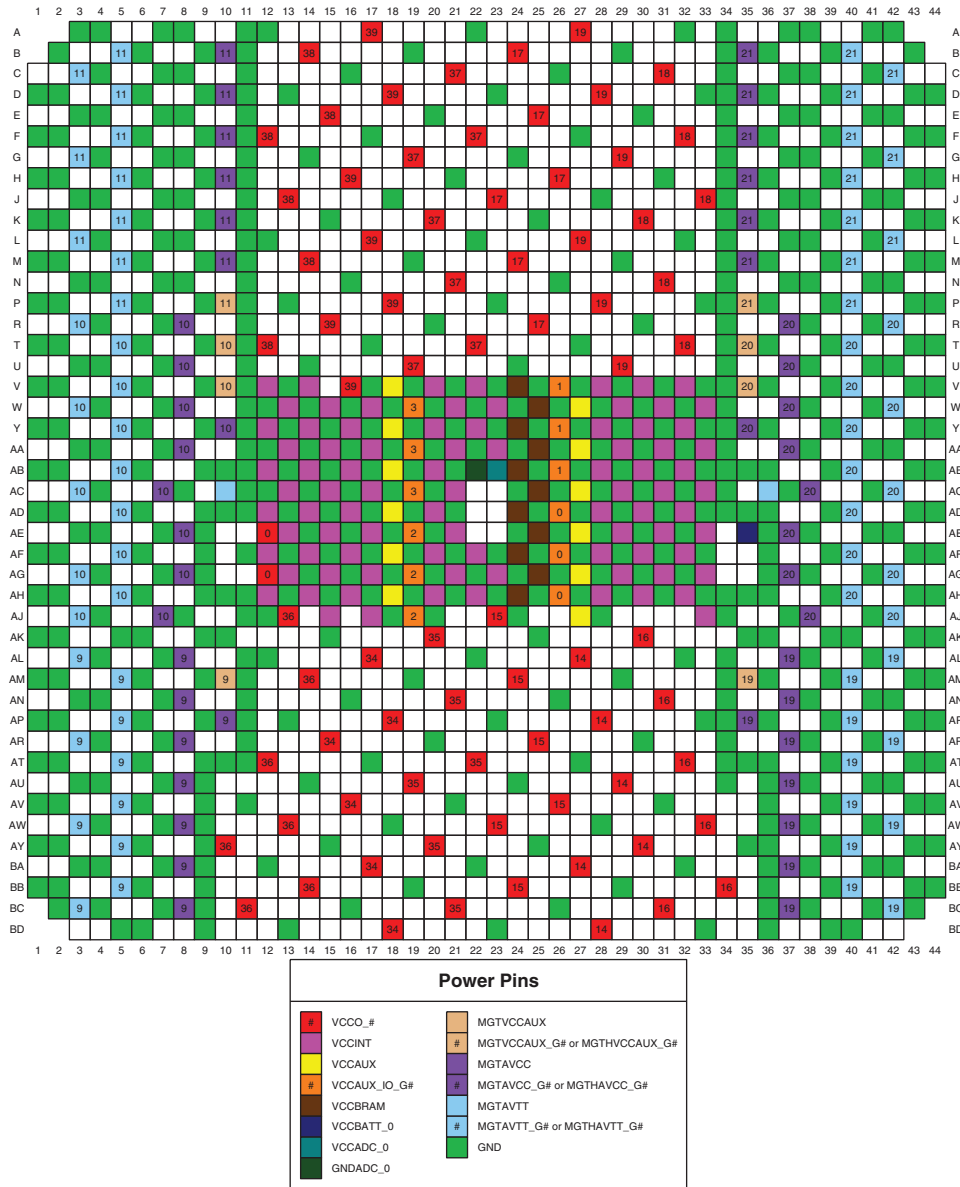

Figure 3-99: FF/FFG1927 Packages—7VX415T Memory Groupings



ug475\_c3\_120\_122811

Figure 3-100: FF/FFG1927 Packages—7VX415T Power and GND Placement

### FF/FFG1157 Packages—7VX485T

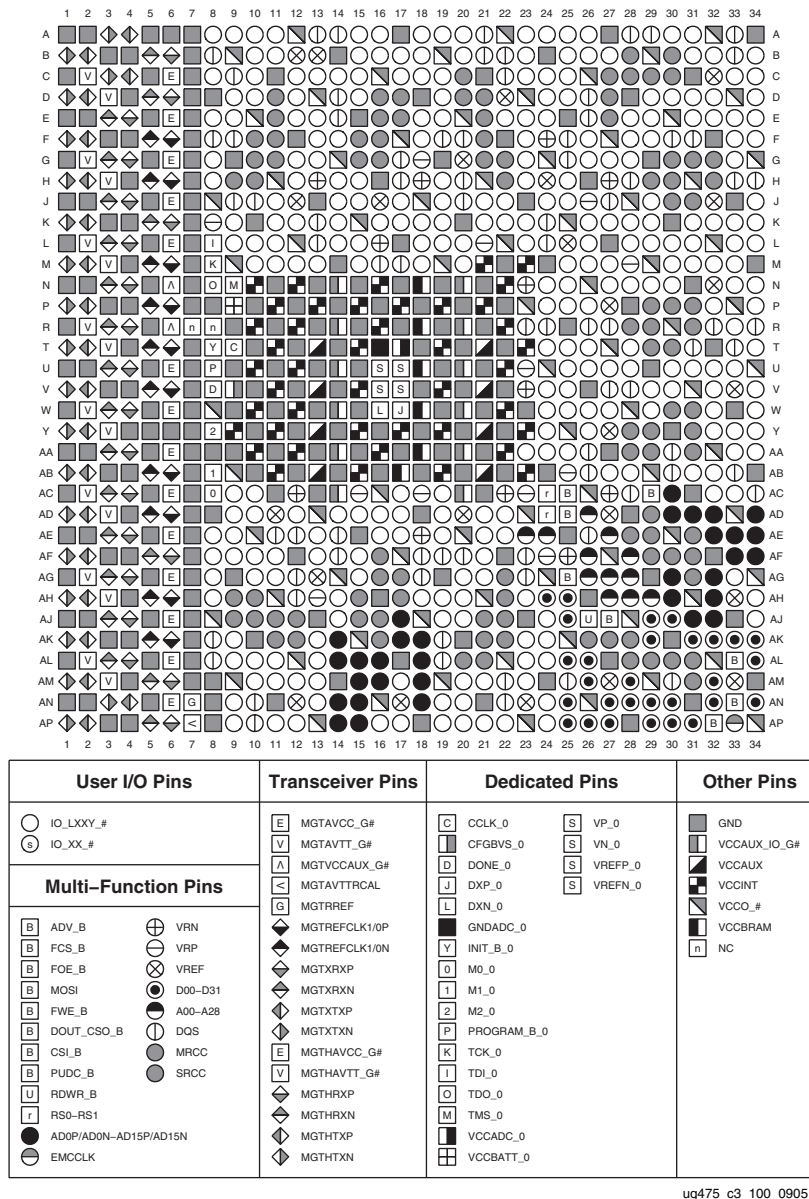

Figure 3-101: FF/FFG1157 Packages—7VX485T Pinout Diagram

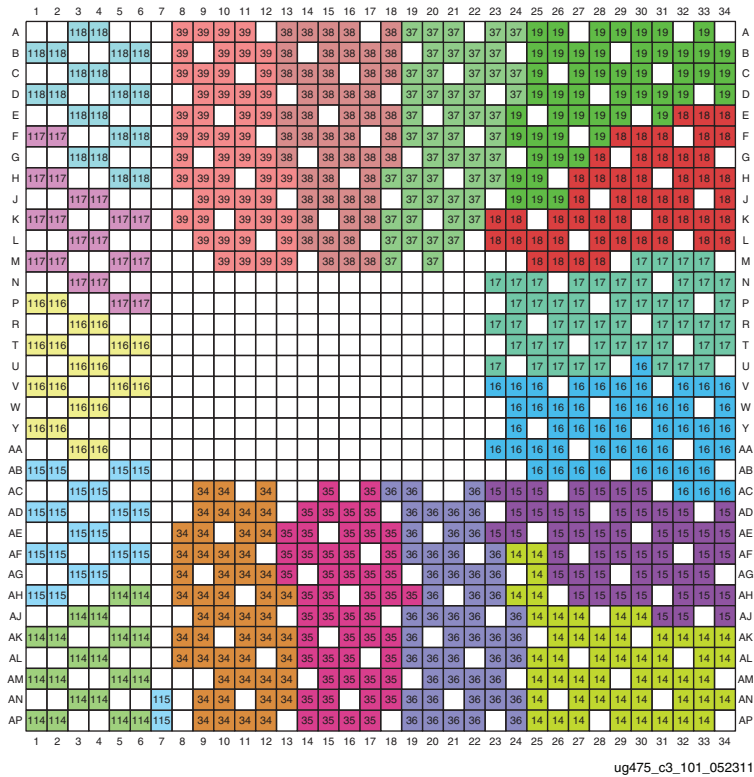
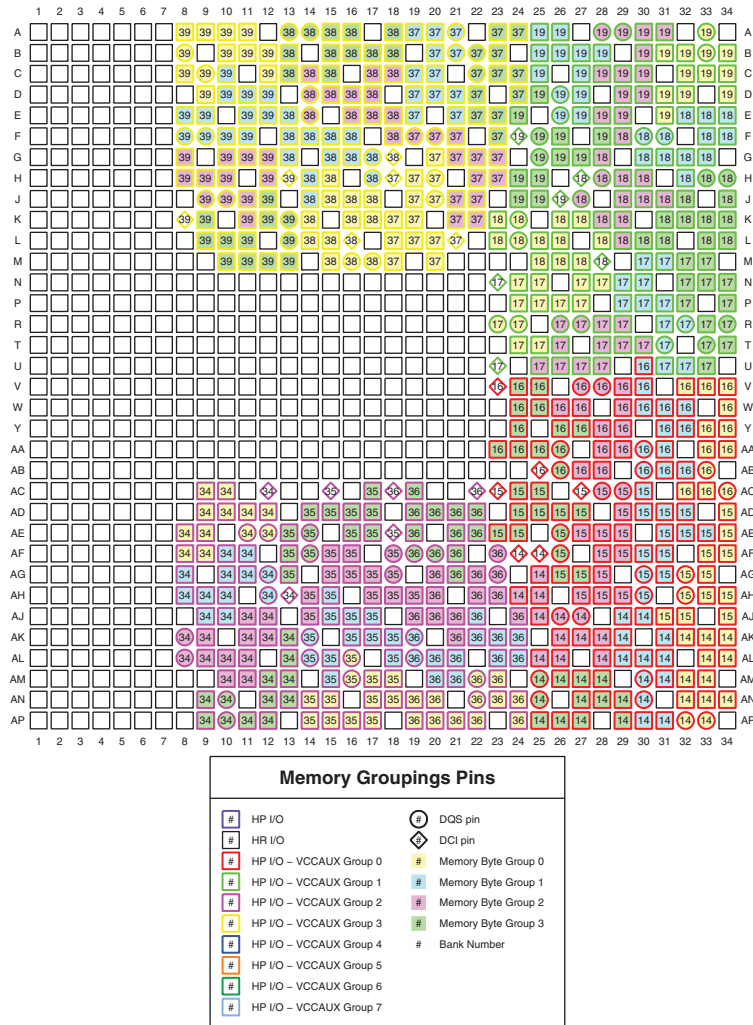
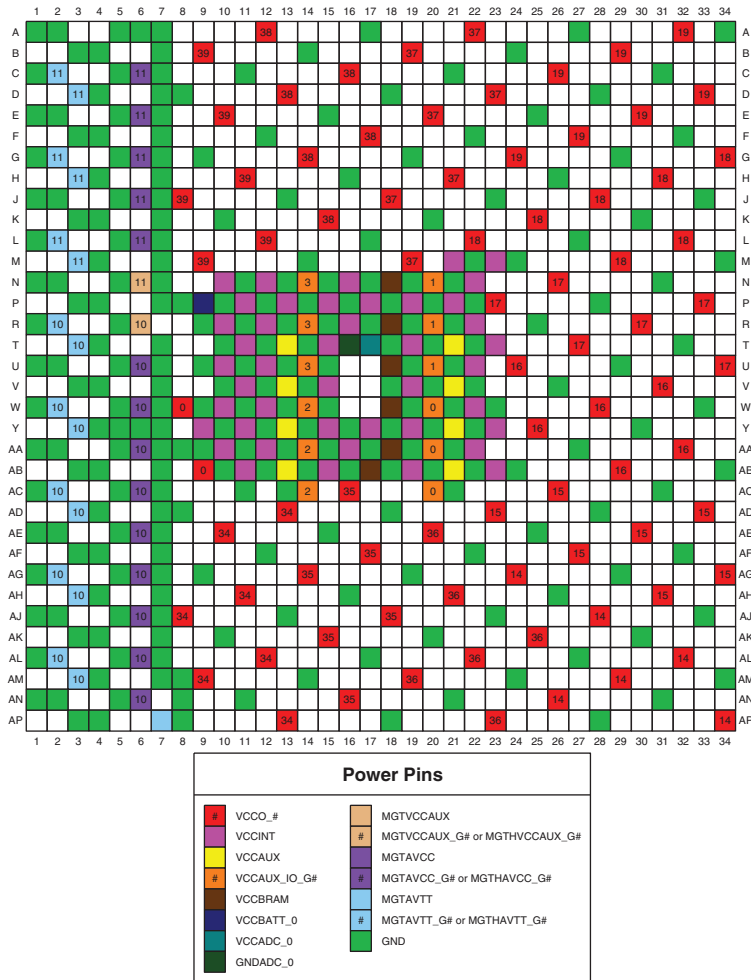

Figure 3-102: FF/FG1157 Packages—7VX485T I/O Banks



ug475\_c3\_102\_052311

Figure 3-103: FF/FFG1157 Packages—7VX485T Memory Groupings



ug475\_c3\_103\_052311

Figure 3-104: FF/FFG1157 Packages—7VX485T Power and GND Placement

### FF/FFG1158 Packages—7VX485T

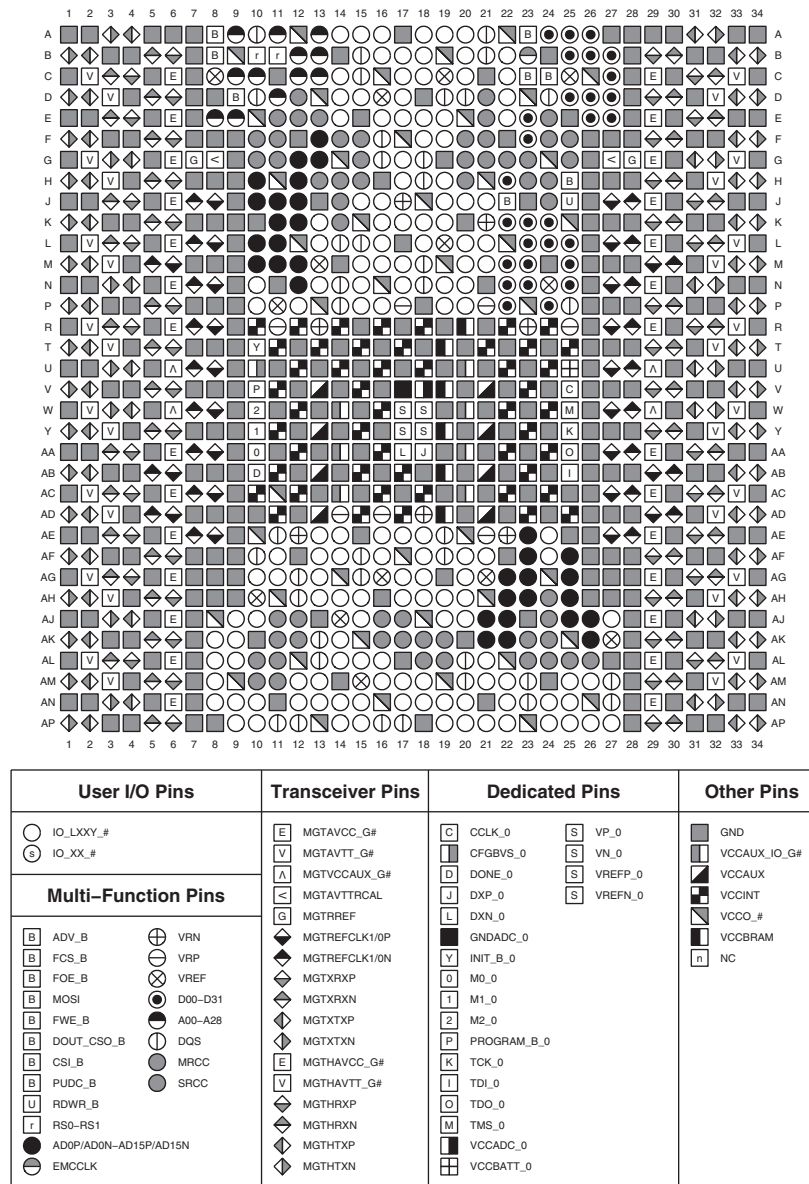

ug475\_c3\_104\_090511

Figure 3-105: FF/FFG1158 Packages—7VX485T Pinout Diagram

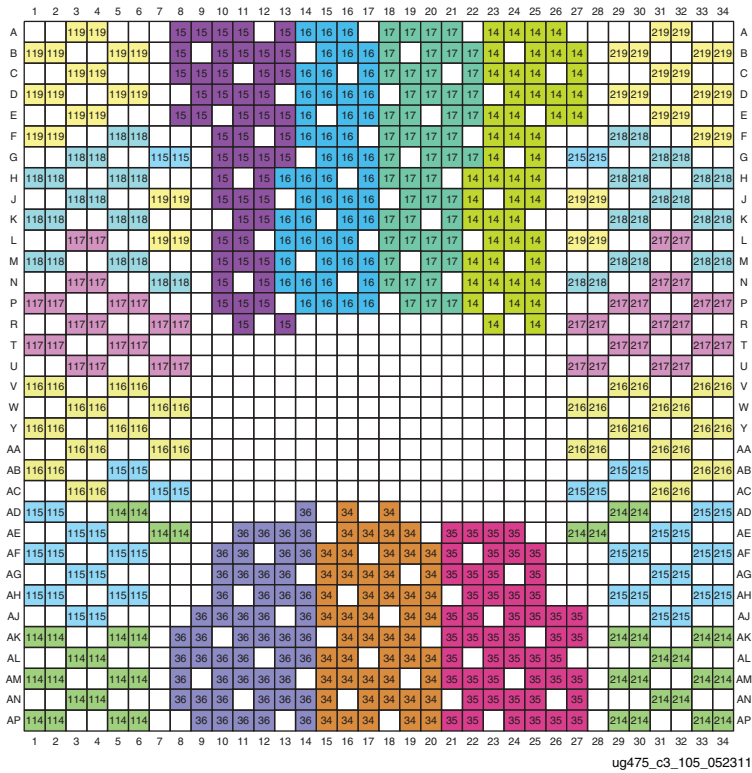
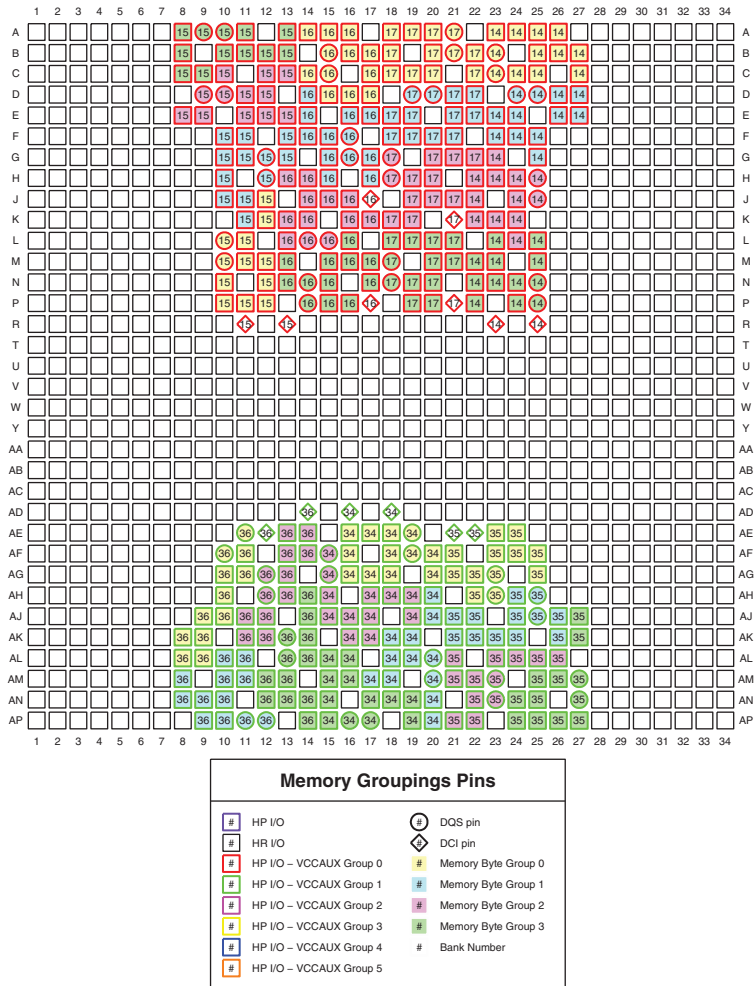

Figure 3-106: FF/FG1158 Packages—7VX485T I/O Banks





ug475\_c3\_106\_052311

Figure 3-107: FF/FFG1158 Packages—7VX485T Memory Groupings

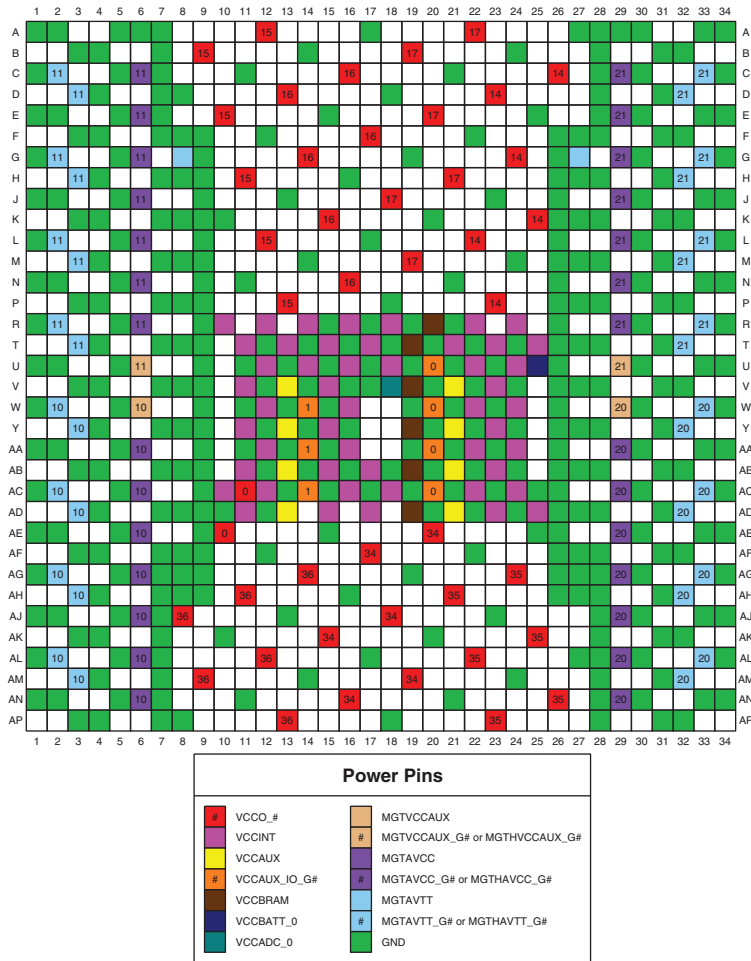

ug475\_c3\_107\_052311

Figure 3-108: FF/FG1158 Packages—7VX485T Power and GND Placement

## FF/FFG1761 and RF1761 Packages—7VX485T

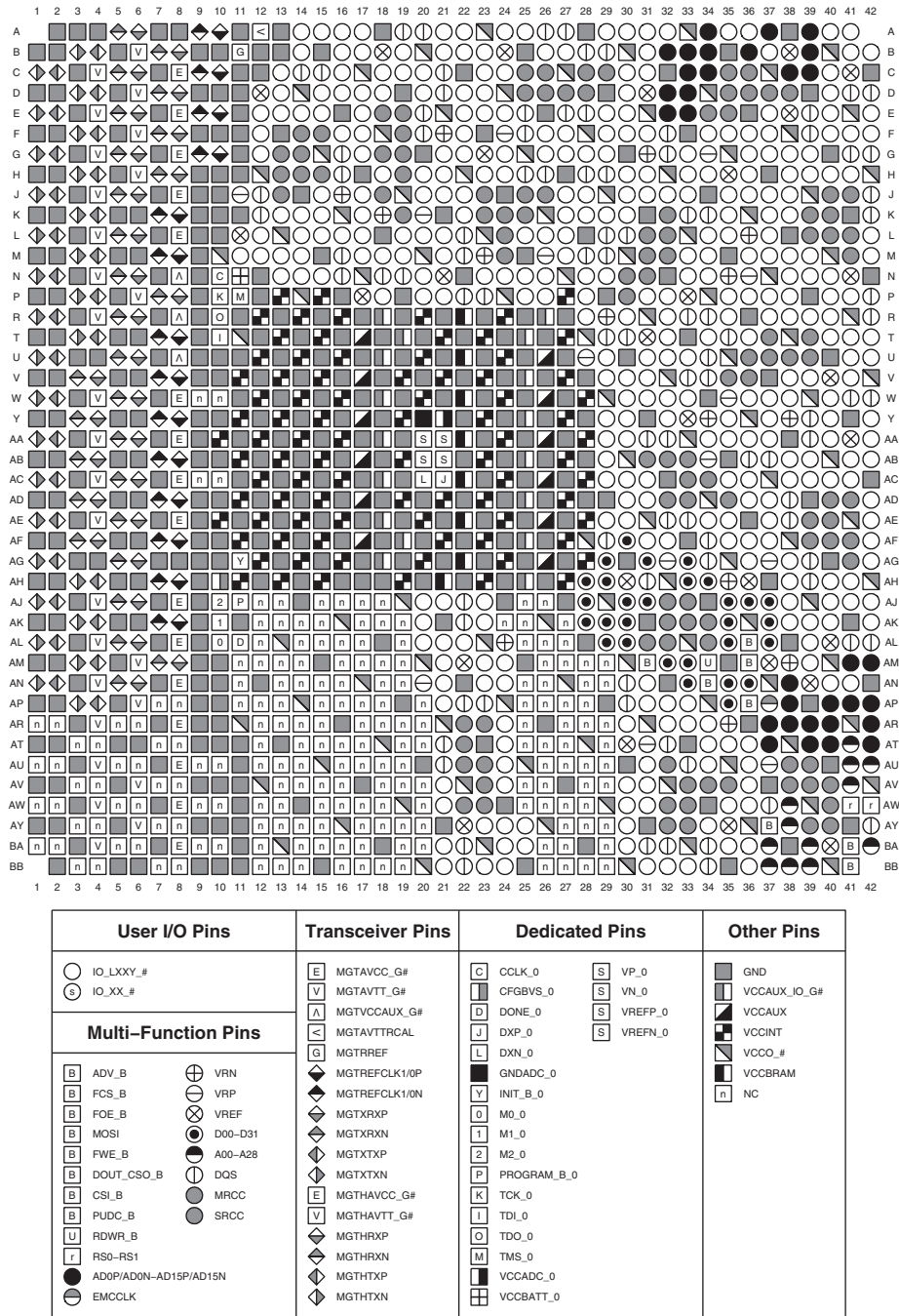

ug475\_c3\_108\_090511

Figure 3-109: FF/FFG1761 and RF1761 Packages—7VX485T Pinout Diagram



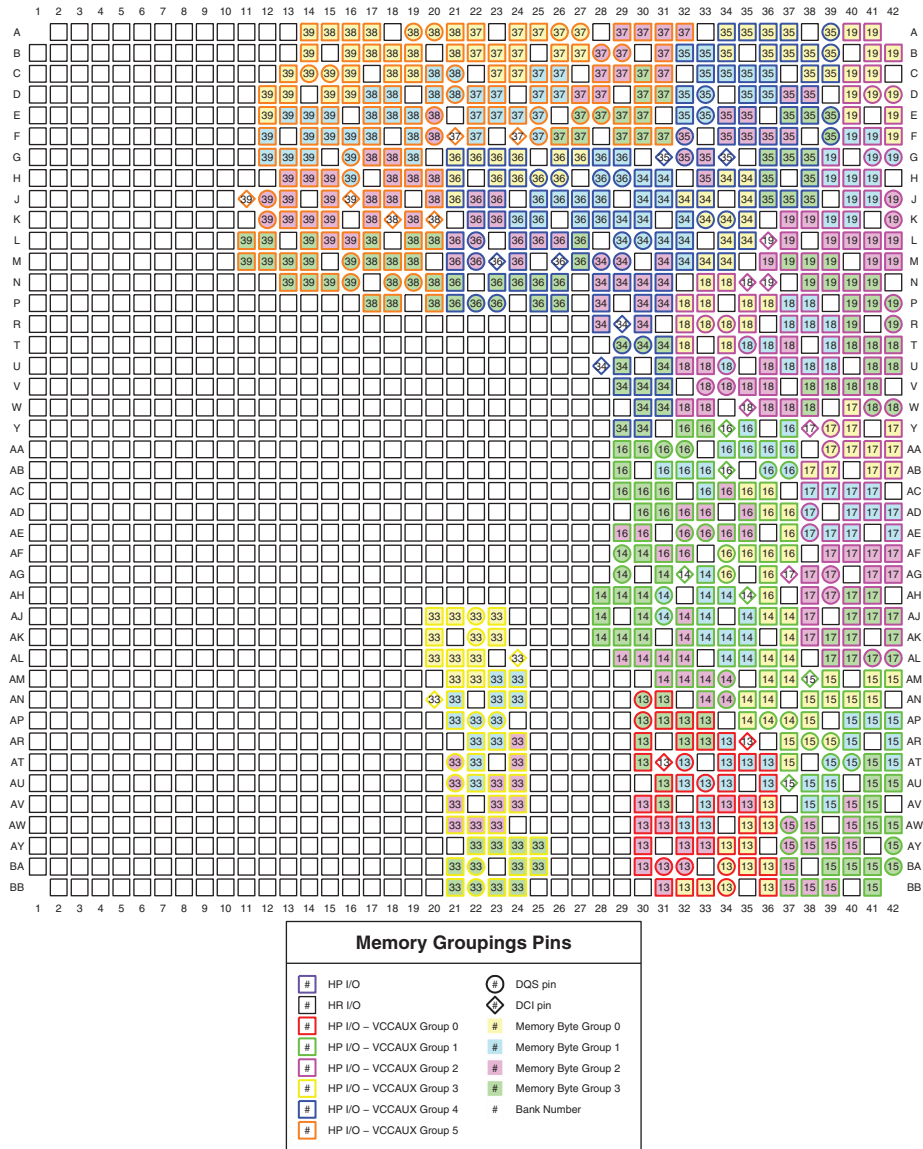

ug475\_c3\_110\_052311

Figure 3-111: FF/FFG1761 and RF1761 Packages—7VX485T Memory Groupings

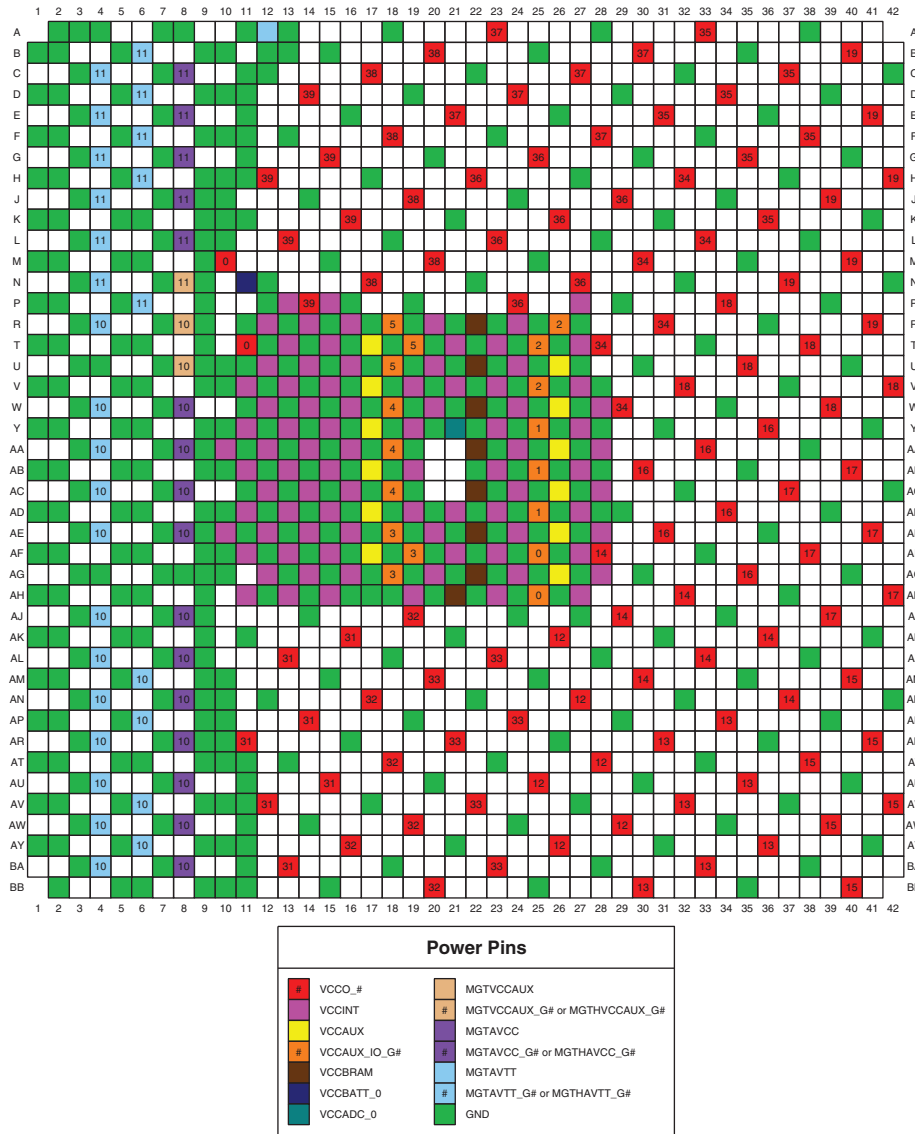

ug475\_c3\_111\_052311

Figure 3-112: FF/FFG1761 and RF1761 Packages—7VX485T Power and GND Placement

# FF/FFG1927 Packages—7VX485T

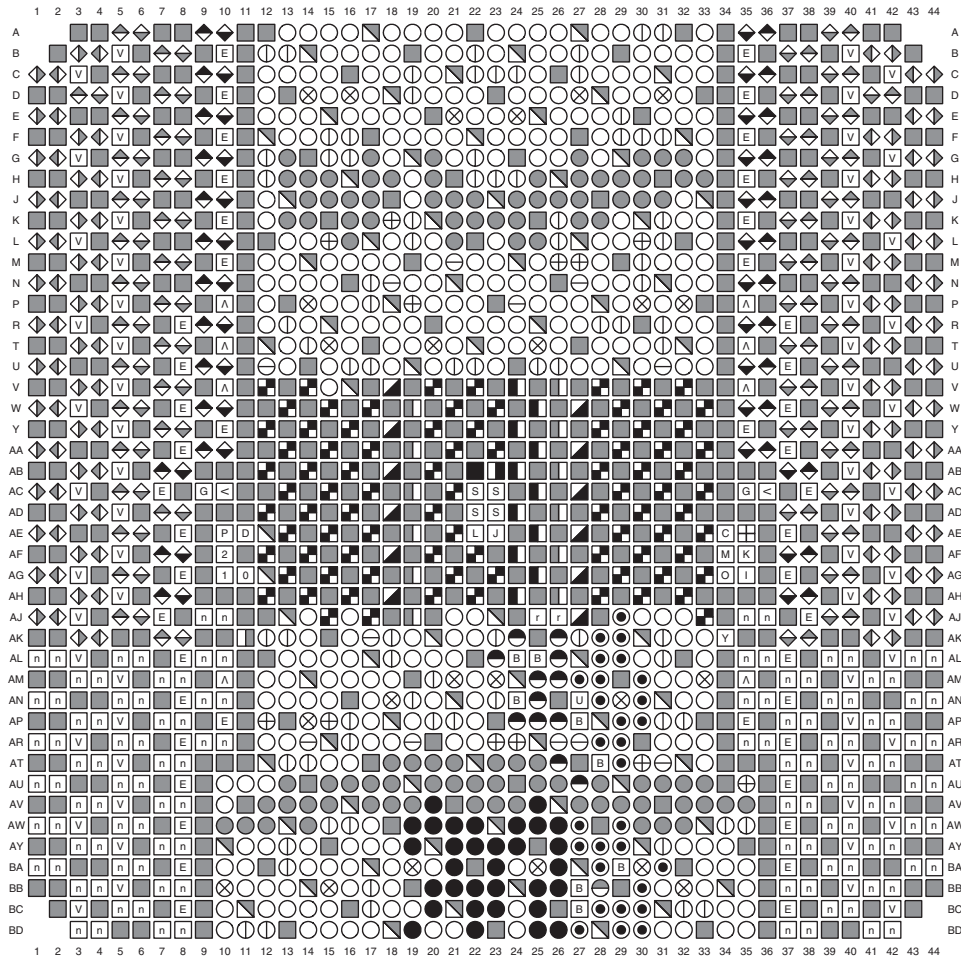

User I/O Pins	Transceiver Pins	Dedicated Pins	Other Pins
<ul style="list-style-type: none"> <li>○ IO_LXXY_#</li> <li>⊙ IO_XX_#</li> </ul>	<ul style="list-style-type: none"> <li>⊞ MGTAVCC_G#</li> <li>⊞ MGTAVTT_G#</li> <li>⊞ MGTAVCCAUX_G#</li> <li>⊞ MGTAVTTRCAL</li> <li>⊞ MGTAREF</li> <li>⊞ MGTREFCLK1/0P</li> <li>⊞ MGTREFCLK1/0N</li> <li>⊞ MGTXRXP</li> <li>⊞ MGTXRXN</li> <li>⊞ MGXTXP</li> <li>⊞ MGXTXN</li> <li>⊞ MGTHAVCC_G#</li> <li>⊞ MGTHAVTT_G#</li> <li>⊞ MGTHRXP</li> <li>⊞ MGTHRXN</li> <li>⊞ MGHTXP</li> <li>⊞ MGHTXN</li> </ul>	<ul style="list-style-type: none"> <li>⊞ CCLK_0</li> <li>⊞ CFGBVS_0</li> <li>⊞ DONE_0</li> <li>⊞ DXP_0</li> <li>⊞ DXN_0</li> <li>⊞ GNDADC_0</li> <li>⊞ INIT_B_0</li> <li>⊞ M0_0</li> <li>⊞ M1_0</li> <li>⊞ M2_0</li> <li>⊞ PROGRAM_B_0</li> <li>⊞ TCK_0</li> <li>⊞ TDI_0</li> <li>⊞ TDO_0</li> <li>⊞ TMS_0</li> <li>⊞ VCCADC_0</li> <li>⊞ VCCBATT_0</li> </ul>	<ul style="list-style-type: none"> <li>⊞ VP_0</li> <li>⊞ VN_0</li> <li>⊞ VREFP_0</li> <li>⊞ VREFN_0</li> <li>⊞ GND</li> <li>⊞ VCCAUX_IO_G#</li> <li>⊞ VCCAUX</li> <li>⊞ VCCINT</li> <li>⊞ VCCO_#</li> <li>⊞ VCCBRAM</li> <li>⊞ NC</li> </ul>
Multi-Function Pins			
<ul style="list-style-type: none"> <li>⊞ ADV_B</li> <li>⊞ FCS_B</li> <li>⊞ FOE_B</li> <li>⊞ MOSI</li> <li>⊞ FWE_B</li> <li>⊞ DOUT_CSO_B</li> <li>⊞ CSL_B</li> <li>⊞ PUDC_B</li> <li>⊞ RDWR_B</li> <li>⊞ RS0-RS1</li> <li>⊞ AD0P/AD0N-AD15P/AD15N</li> <li>⊞ EMCCLK</li> <li>⊞ VRN</li> <li>⊞ VRP</li> <li>⊞ VREF</li> <li>⊞ D00-D31</li> <li>⊞ A00-A28</li> <li>⊞ DQS</li> <li>⊞ MRCC</li> <li>⊞ SRCC</li> </ul>			

ug475\_c3\_112\_090511

Figure 3-113: FF/FFG1927 Packages—7VX485T Pinout Diagram

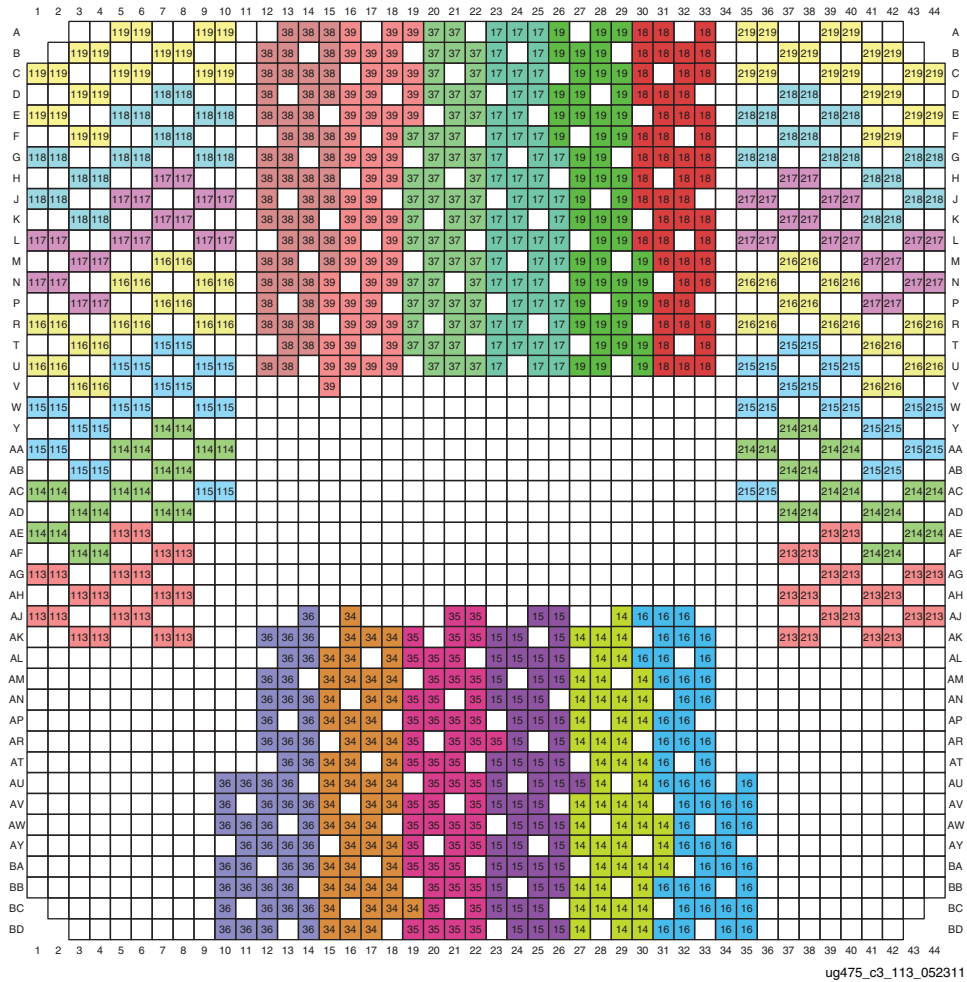
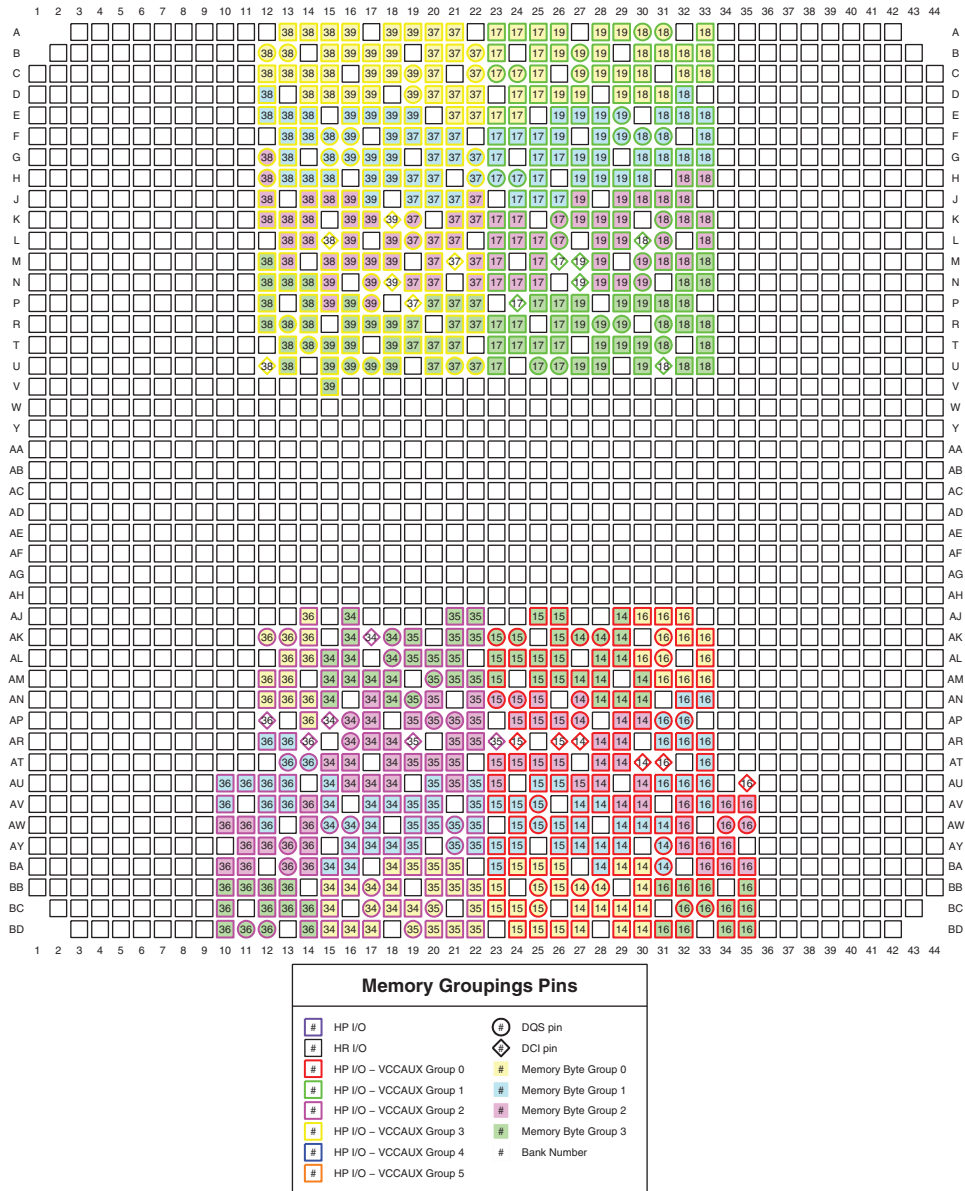

Figure 3-114: FF/FG1927 Packages—7VX485T I/O Banks





ug475\_c3\_114\_052311

Figure 3-115: FF/FFG1927 Packages—7VX485T Memory Groupings

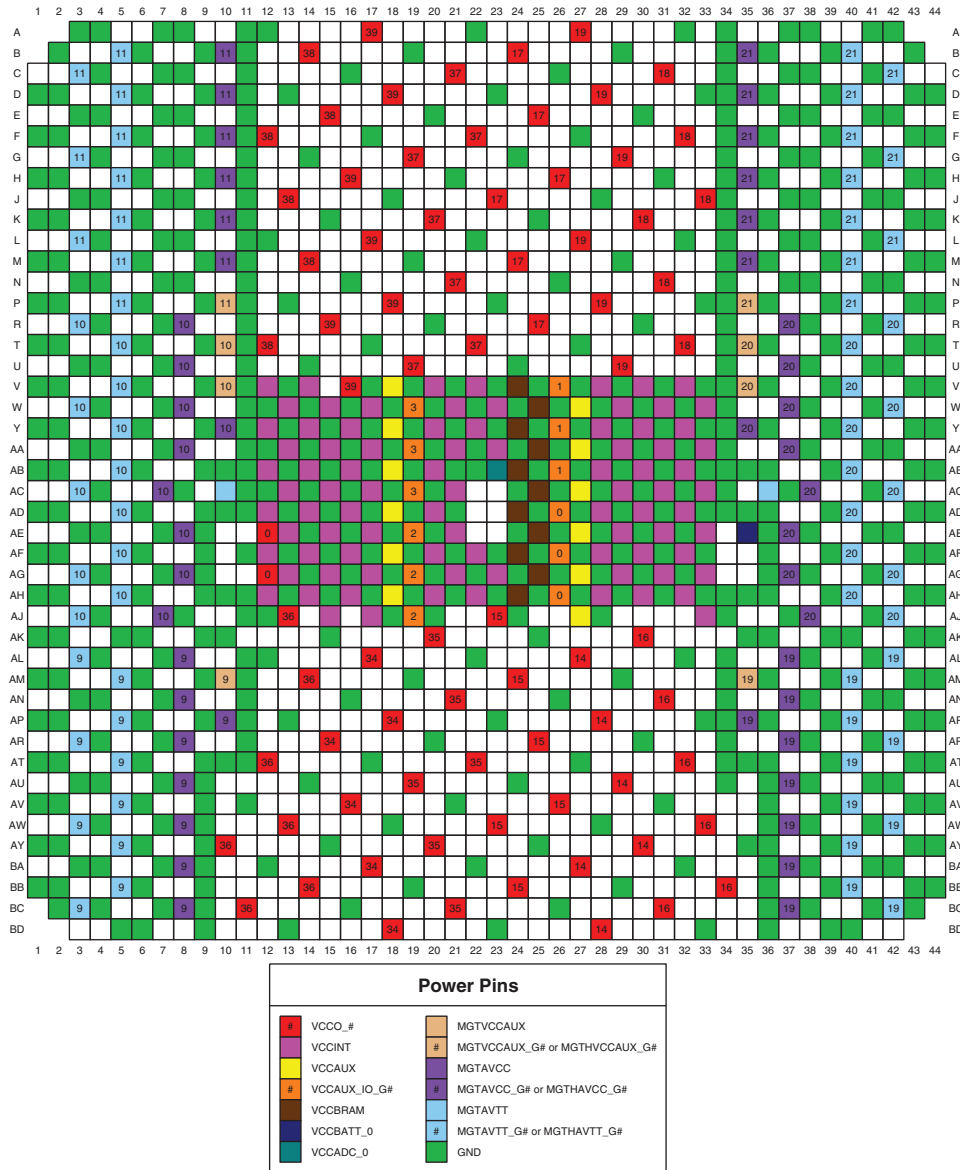

ug475\_c3\_115\_052311

Figure 3-116: FF/FFG1927 Packages—7VX485T Power and GND Placement

## FF/FFG1930 and RF1930 Packages—7VX485T

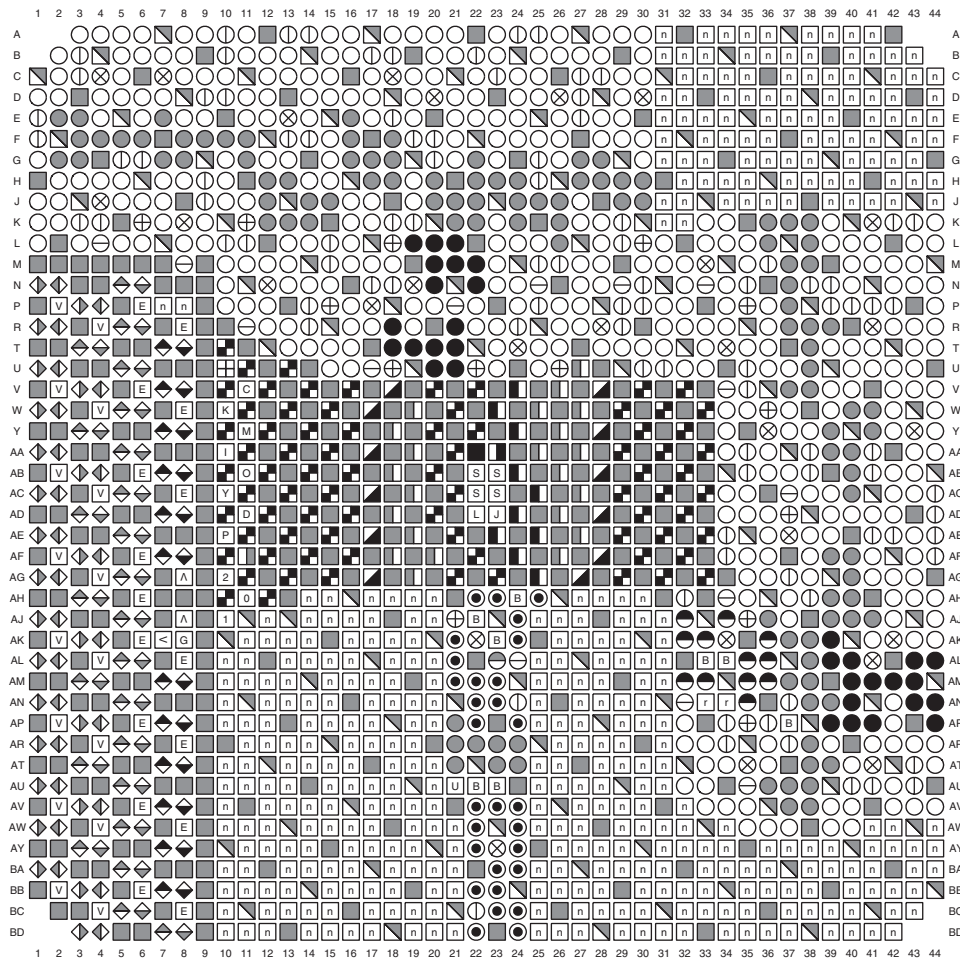

User I/O Pins	Transceiver Pins	Dedicated Pins	Other Pins
<ul style="list-style-type: none"> <li>○ IO_LXXY_#</li> <li>○ IO_XX_#</li> </ul>	<ul style="list-style-type: none"> <li>[E] MGTAVCC_G#</li> <li>[V] MGTAVTT_G#</li> <li>[A] MGTVCCAUX_G#</li> <li>[&lt;] MGTAVTTRCAL</li> <li>[G] MGTREFREF</li> <li>◆ MGTREFCLK1/0P</li> <li>◆ MGTREFCLK1/0N</li> <li>◆ MGTXRXP</li> <li>◆ MGTXRXN</li> <li>◆ MGTXTXP</li> <li>◆ MGTXTXN</li> <li>[E] MGTHAVCC_G#</li> <li>[V] MGTHAVTT_G#</li> <li>◆ MGTHRXP</li> <li>◆ MGTHRXN</li> <li>◆ MGHTHXP</li> <li>◆ MGHTTXN</li> </ul>	<ul style="list-style-type: none"> <li>[C] CCLK_0</li> <li>[D] CFGBVS_0</li> <li>[D] DONE_0</li> <li>[J] DXP_0</li> <li>[L] DXN_0</li> <li>■ GNDADC_0</li> <li>[Y] INIT_B_0</li> <li>[0] M0_0</li> <li>[1] M1_0</li> <li>[2] M2_0</li> <li>[P] PROGRAM_B_0</li> <li>[K] TCK_0</li> <li>[I] TDI_0</li> <li>[O] TDO_0</li> <li>[M] TMS_0</li> <li>■ VCCADC_0</li> <li>[H] VCCBATT_0</li> <li>[S] VP_0</li> <li>[S] VN_0</li> <li>[S] VREFP_0</li> <li>[S] VREFN_0</li> </ul>	<ul style="list-style-type: none"> <li>■ GND</li> <li>■ VCCAUX_IO_G#</li> <li>■ VCCAUX</li> <li>■ VCCINT</li> <li>■ VCCO_#</li> <li>■ VCCBRAM</li> <li>■ NC</li> </ul>
<b>Multi-Function Pins</b>			
<ul style="list-style-type: none"> <li>[B] ADV_B</li> <li>[B] FCS_B</li> <li>[B] FOE_B</li> <li>[B] MOSI</li> <li>[B] FWE_B</li> <li>[B] DOUT_CSO_B</li> <li>[B] CSI_B</li> <li>[B] PUDC_B</li> <li>[U] RDWR_B</li> <li>[I] RSO-RS1</li> <li>● AD0P/AD0N-AD15P/AD15N</li> <li>⊖ EMCCLK</li> </ul>	<ul style="list-style-type: none"> <li>⊕ VRN</li> <li>⊖ VRP</li> <li>⊗ VREF</li> <li>● D00-D31</li> <li>● A00-A28</li> <li>○ DQS</li> <li>● MRCC</li> <li>● SRCC</li> </ul>		

ug475\_c3\_116\_090511

Figure 3-117: FF/FFG1930 and RF1930 Packages—7VX485T Pinout Diagram

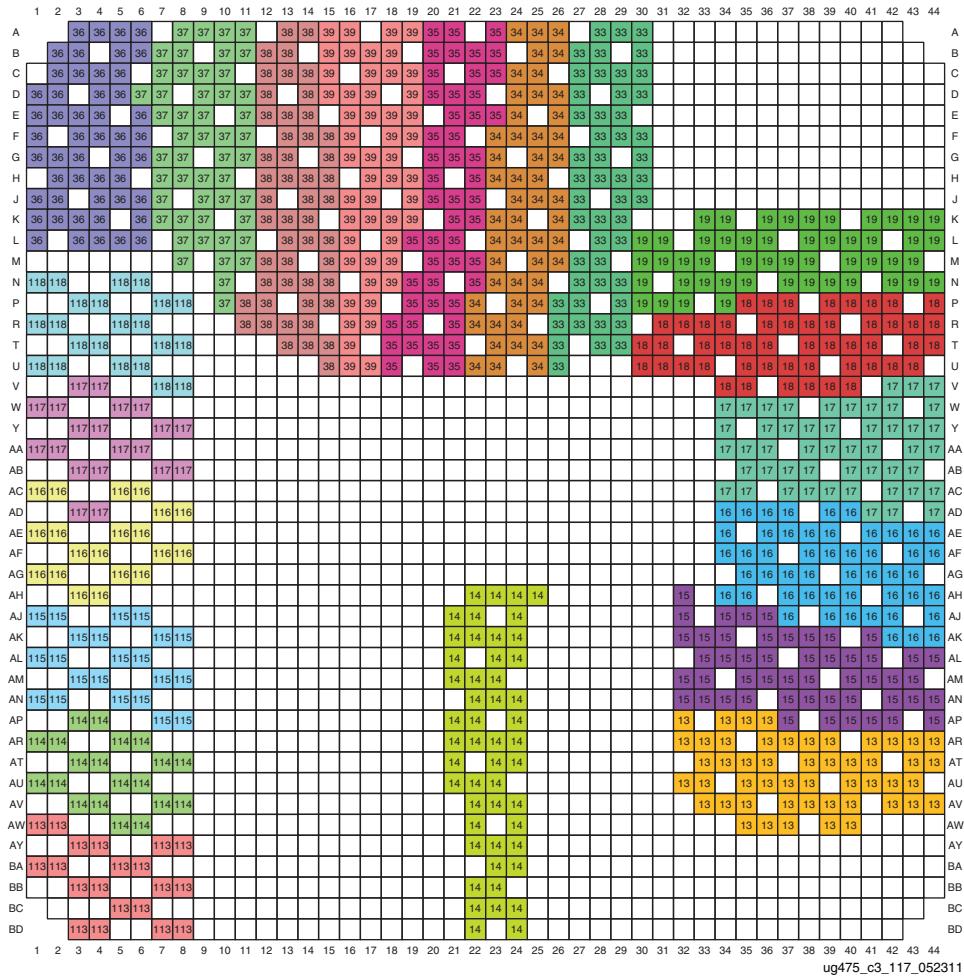
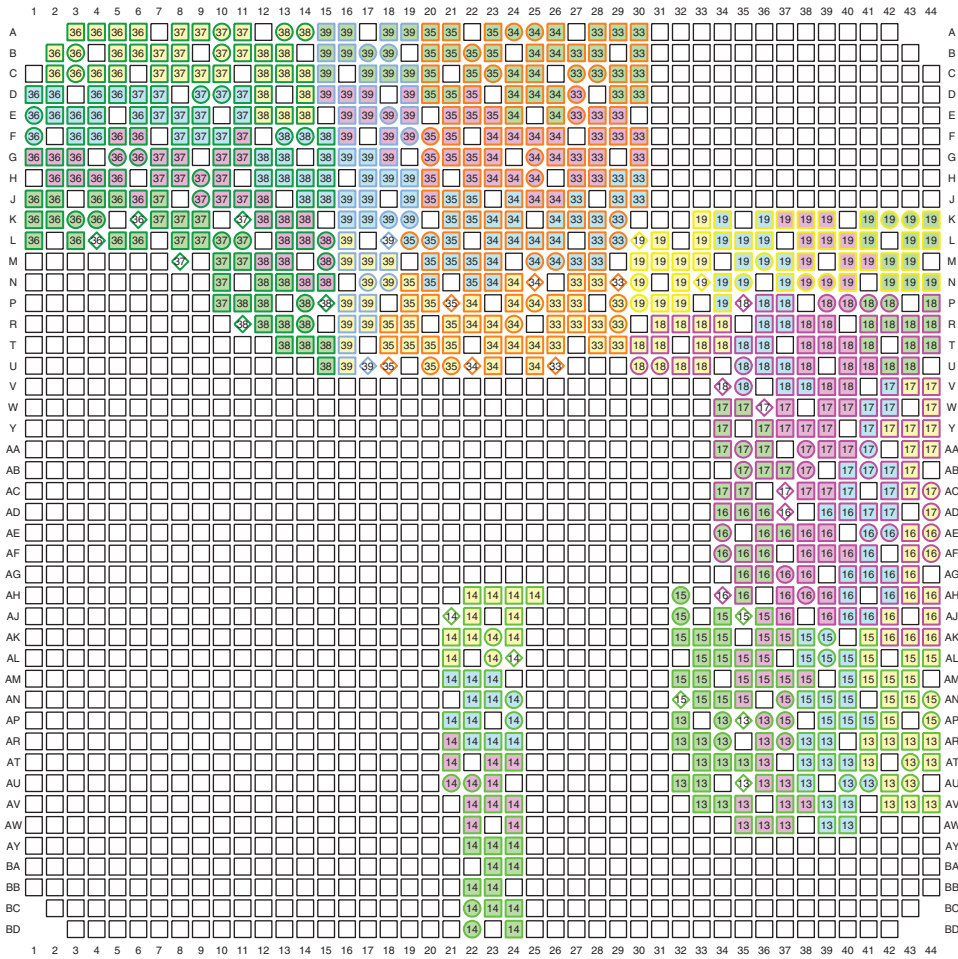

Figure 3-118: FF/FFG1930 and RF1930 Packages—7VX485T I/O Banks



Memory Groupings Pins			
#	HP I/O	⊕	DQS pin
#	HR I/O	⊕	DCI pin
#	HP I/O – VCCAUX Group 0	#	Memory Byte Group 0
#	HP I/O – VCCAUX Group 1	#	Memory Byte Group 1
#	HP I/O – VCCAUX Group 2	#	Memory Byte Group 2
#	HP I/O – VCCAUX Group 3	#	Memory Byte Group 3
#	HP I/O – VCCAUX Group 4	#	Bank Number
#	HP I/O – VCCAUX Group 5		
#	HP I/O – VCCAUX Group 6		
#	HP I/O – VCCAUX Group 7		

ug475\_c3\_118\_052311

Figure 3-119: FF/FFG1930 and RF1930 Packages—7VX485T Memory Groupings

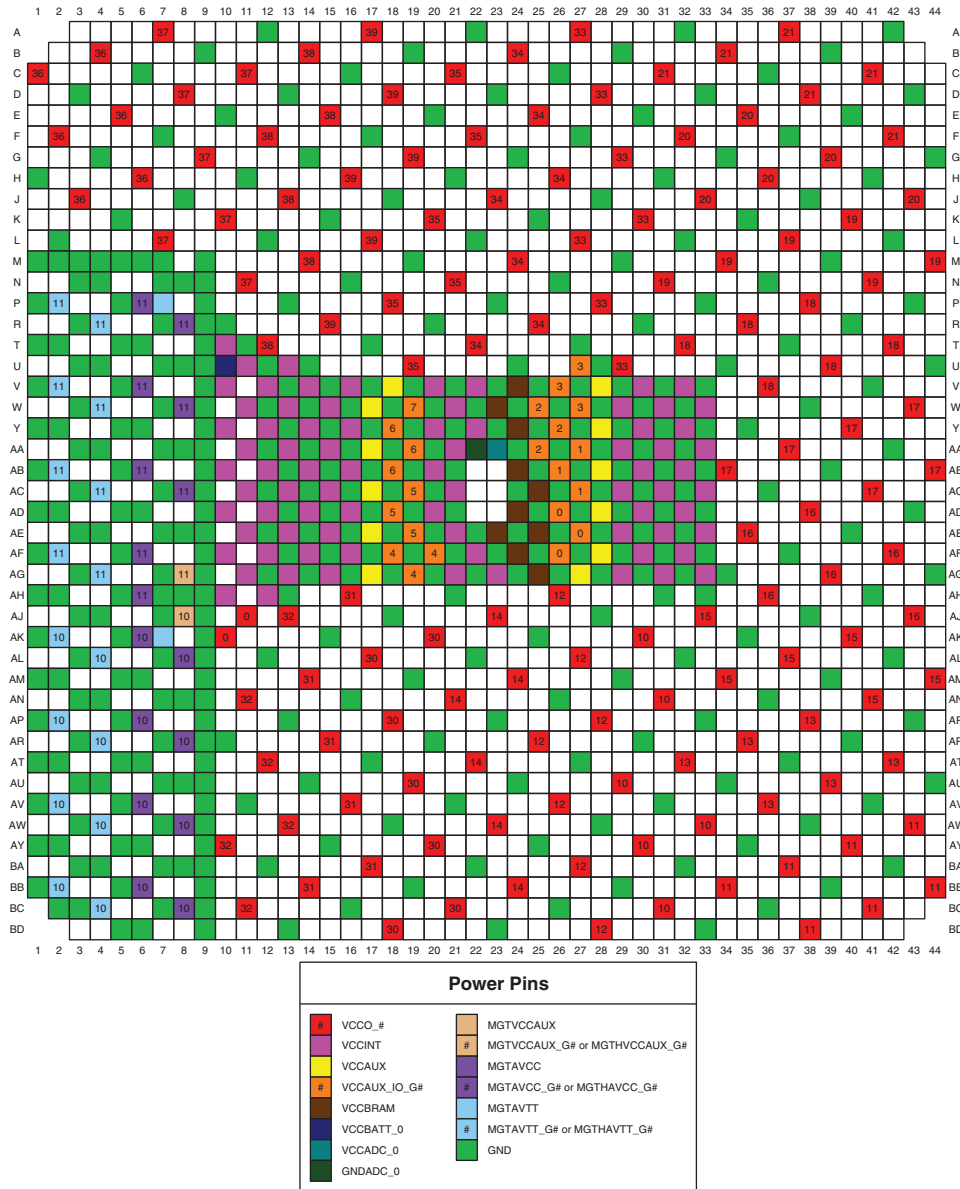

ug475\_c3\_140\_122811

Figure 3-120: FF/FFG1930 and RF1930 Packages—7VX485T Power and GND Placement

## FF/FFG1761 and RF1761 Packages—7VX690T

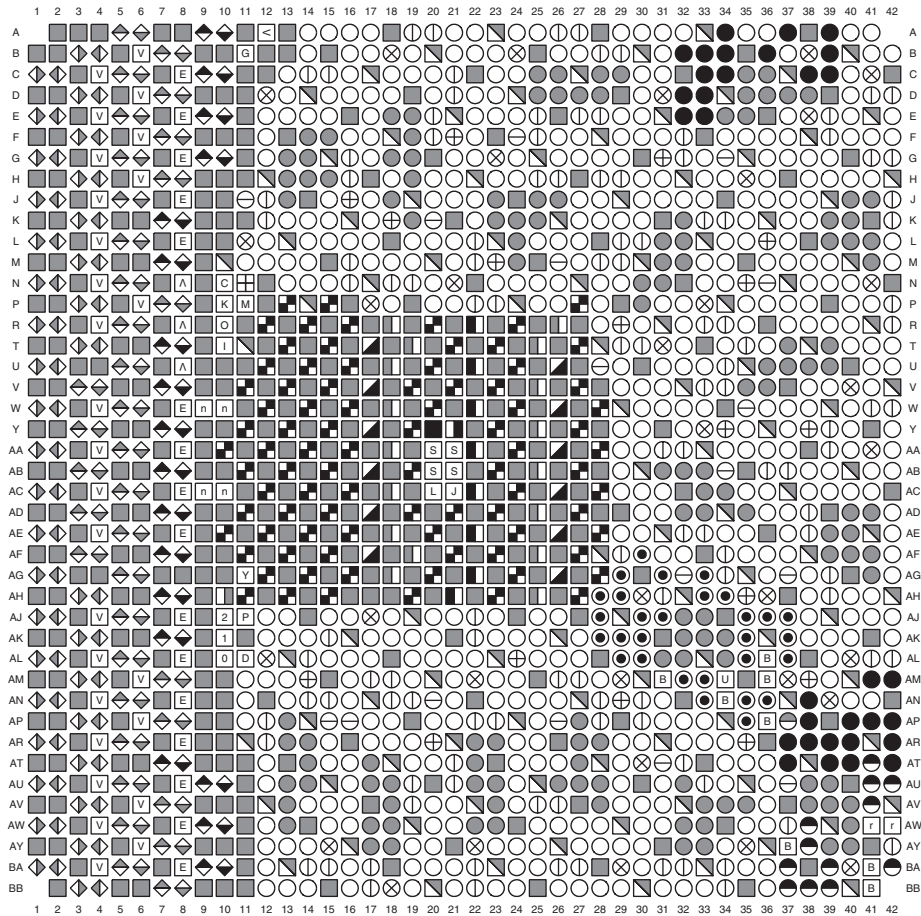

User I/O Pins	Transceiver Pins	Dedicated Pins	Other Pins
<ul style="list-style-type: none"> <li>○ IO_LXXY_#</li> <li>⊙ IO_XX_#</li> </ul>	<ul style="list-style-type: none"> <li>[E] MGTAVCC_G#</li> <li>[V] MGTAVTT_G#</li> <li>[A] MGTVCCAUX_G#</li> <li>[&lt;] MGTAVTTRCAL</li> <li>[G] MGTTRREF</li> <li>◆ MGTREFCLK1/0P</li> <li>◆ MGTREFCLK1/0N</li> <li>◆ MGTXRXP</li> <li>◆ MGTXRXXN</li> <li>◆ MGTXTXP</li> <li>◆ MGTXTXN</li> <li>[E] MGTAVCC_G#</li> <li>[V] MGTAVTT_G#</li> <li>◆ MGTXRXP</li> <li>◆ MGTXRXXN</li> <li>◆ MGTHTXP</li> <li>◆ MGTHTXN</li> </ul>	<ul style="list-style-type: none"> <li>[C] CCLK_0</li> <li>[I] CFGBVS_0</li> <li>[D] DONE_0</li> <li>[J] DXP_0</li> <li>[L] DXN_0</li> <li>■ GNDADC_0</li> <li>[Y] INIT_B_0</li> <li>[0] M0_0</li> <li>[1] M1_0</li> <li>[2] M2_0</li> <li>[P] PROGRAM_B_0</li> <li>[K] TCK_0</li> <li>[T] TDI_0</li> <li>[O] TDO_0</li> <li>[M] TMS_0</li> <li>■ VCCADC_0</li> <li>[H] VCCBATT_0</li> <li>[S] VP_0</li> <li>[S] VN_0</li> <li>[S] VREFP_0</li> <li>[S] VREFN_0</li> </ul>	<ul style="list-style-type: none"> <li>■ GND</li> <li>[I] VCCAUX_IO_G#</li> <li>■ VCCAUX</li> <li>■ VCCINT</li> <li>■ VCCO_#</li> <li>■ VCCBRAM</li> <li>[n] NC</li> </ul>
<b>Multi-Function Pins</b>			
<ul style="list-style-type: none"> <li>[B] ADV_B</li> <li>[B] FCS_B</li> <li>[B] FOE_B</li> <li>[B] MOSI</li> <li>[B] FWE_B</li> <li>[B] DOUT_CSO_B</li> <li>[B] CSL_B</li> <li>[B] PUDC_B</li> <li>[U] RDWR_B</li> <li>[I] RSO-RS1</li> <li>● AD0P/AD0N-AD15P/AD15N</li> <li>⊖ EMCCLK</li> <li>⊕ VRN</li> <li>⊖ VRP</li> <li>⊗ VREF</li> <li>● D00-D31</li> <li>● A00-A28</li> <li>⊕ DOS</li> <li>● MRCC</li> <li>● SRCC</li> </ul>			

ug475\_c3\_141\_122811

Figure 3-121: FF/FFG1761 and RF1761 Packages—7VX690T Pinout Diagram

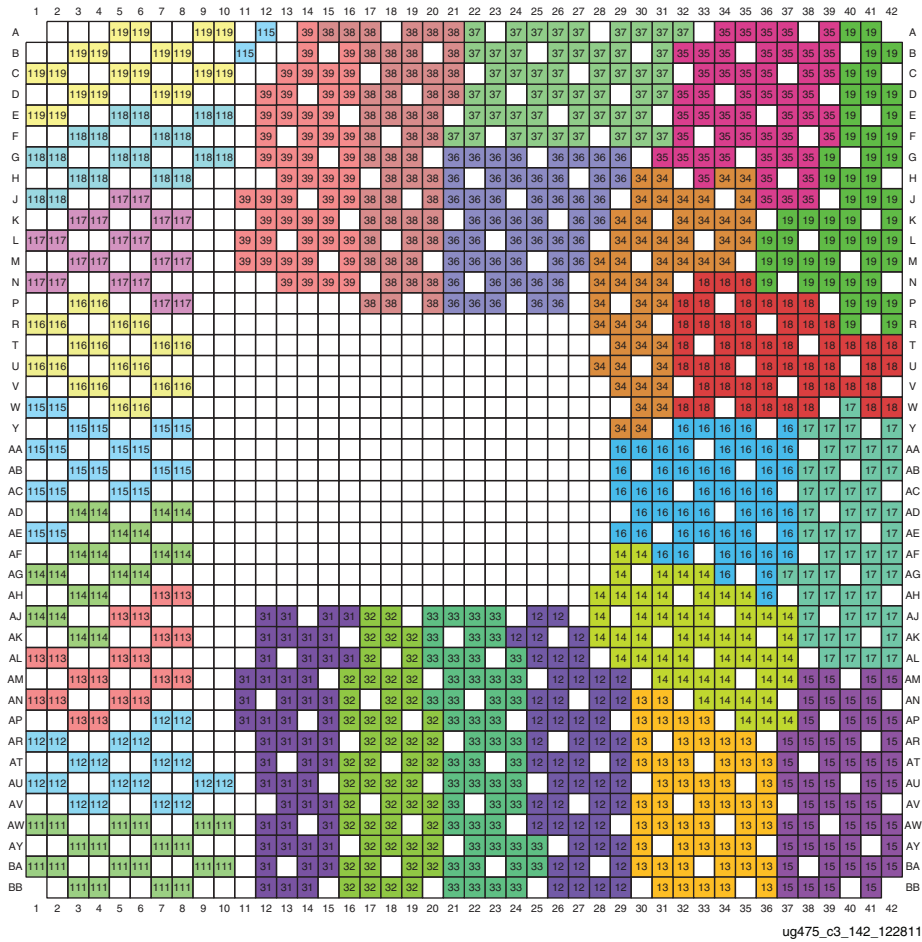
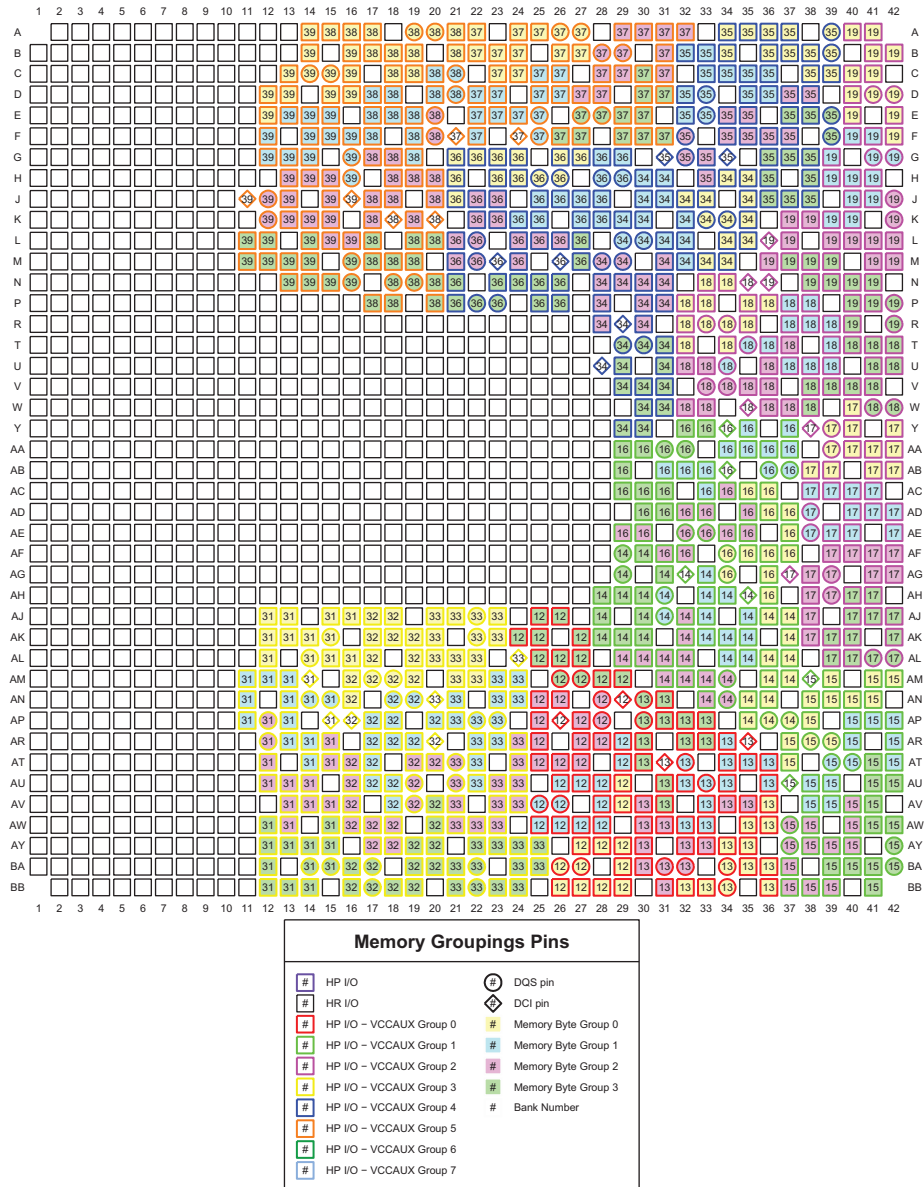

Figure 3-122: FF/FFG1761 and RF1761 Packages—7VX690T I/O Banks





ug475\_c3\_143\_122811

Figure 3-123: FF/FFG1761 and RF1761 Packages—7VX690T Memory Groupings

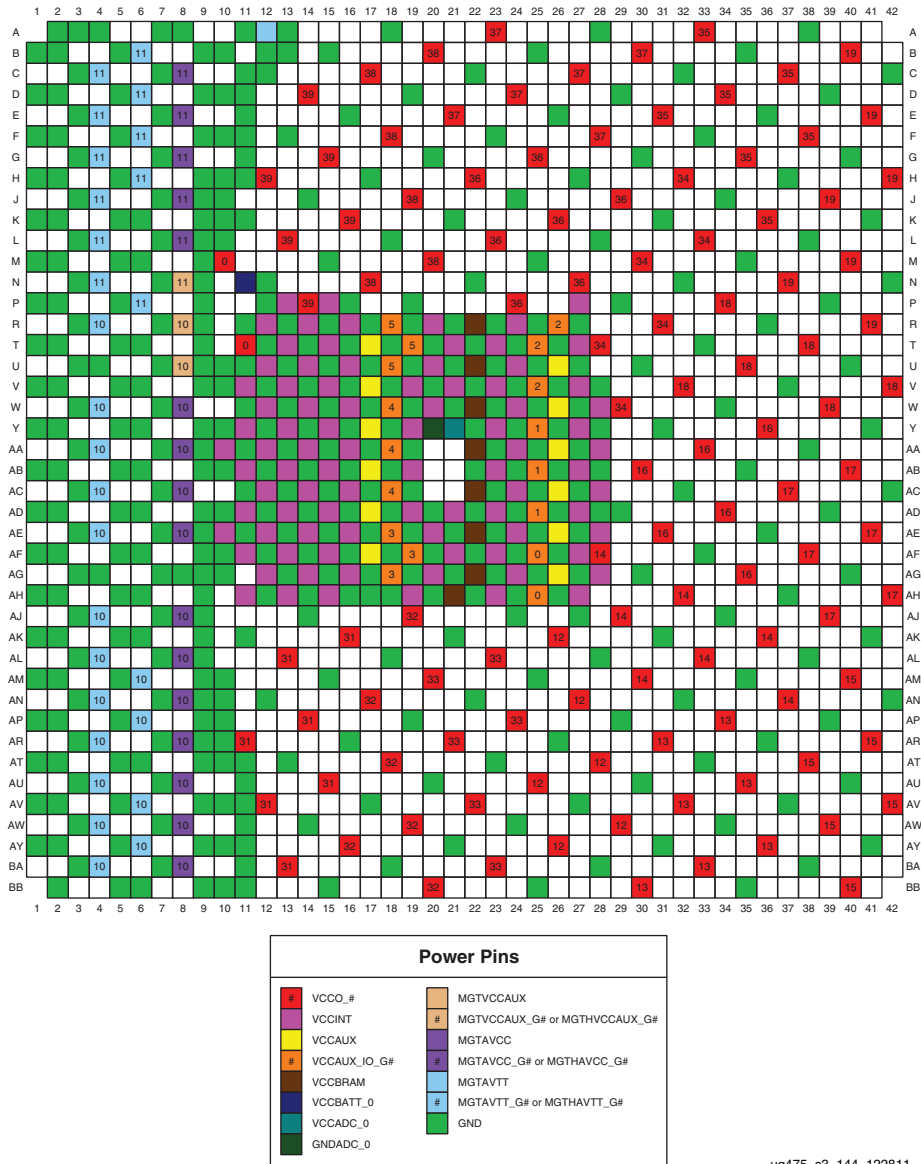
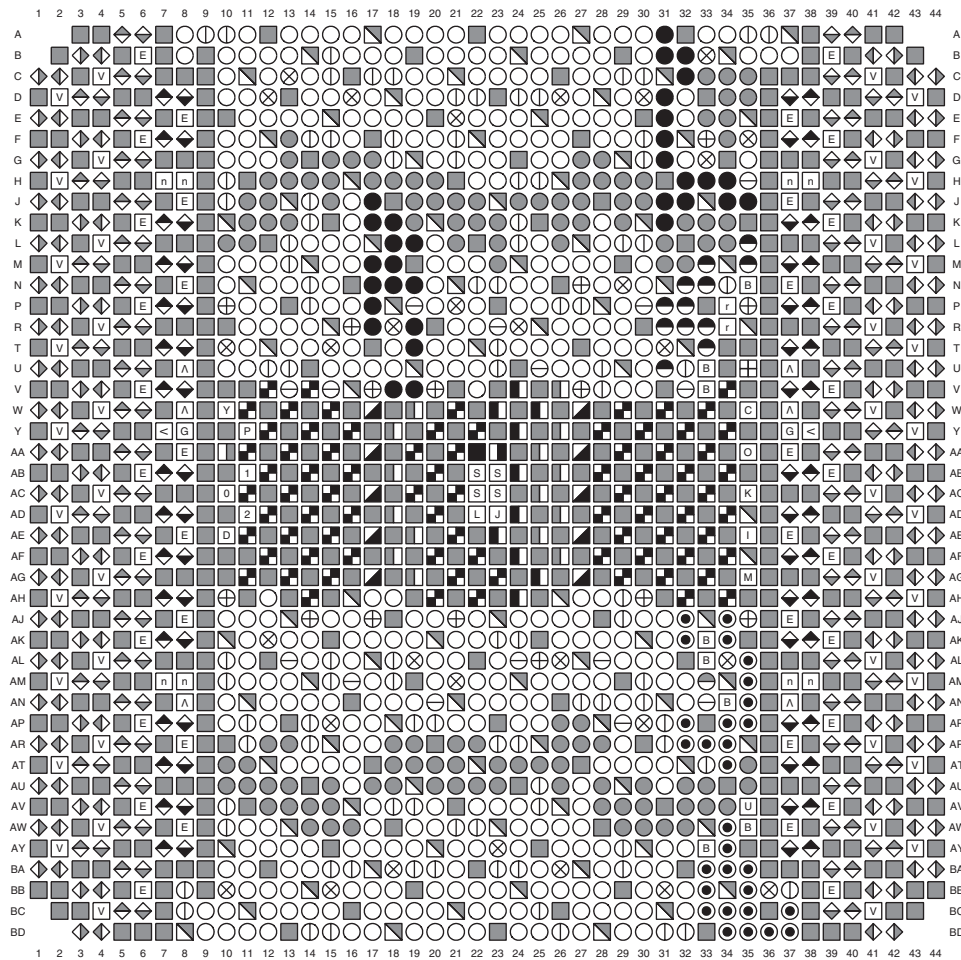

Figure 3-124: FF/FFG1761 and RF1761 Packages—7VX690T Power and GND Placement

## FF/FFG1926 Packages—7VX690T and 7VX980T



User I/O Pins	Transceiver Pins	Dedicated Pins	Other Pins
<ul style="list-style-type: none"> <li>○ IO_LXXY_#</li> <li>○ IO_XX_#</li> </ul>	<ul style="list-style-type: none"> <li>E MGTAVCC_G#</li> <li>V MGTAVTT_G#</li> <li>A MGTVCCAUX_G#</li> <li>&lt; MGTAVTTRCAL</li> <li>G MGTTRREF</li> <li>◆ MGTREFCLK1/0P</li> <li>◆ MGTREFCLK1/0N</li> <li>◆ MGTXRXP</li> <li>◆ MGTXRXP</li> <li>◆ MGTXTXP</li> <li>◆ MGTXTXN</li> <li>E MGTAVCC_G#</li> <li>V MGTAVTT_G#</li> <li>◆ MGTTRXP</li> <li>◆ MGTTRXN</li> <li>◆ MGTHTXP</li> <li>◆ MGTHTXN</li> </ul>	<ul style="list-style-type: none"> <li>C CCLK_0</li> <li>I CFGBVS_0</li> <li>D DONE_0</li> <li>J DXP_0</li> <li>L DXN_0</li> <li>■ GNDADC_0</li> <li>Y INIT_B_0</li> <li>0 M0_0</li> <li>1 M1_0</li> <li>2 M2_0</li> <li>P PROGRAM_B_0</li> <li>K TCK_0</li> <li>I TDI_0</li> <li>O TDO_0</li> <li>M TMS_0</li> <li>■ VCCADC_0</li> <li>■ VCCBATT_0</li> <li>S VP_0</li> <li>S VN_0</li> <li>S VREFP_0</li> <li>S VREFN_0</li> </ul>	<ul style="list-style-type: none"> <li>■ GND</li> <li>■ VCCAUX_IO_G#</li> <li>■ VCCAUX</li> <li>■ VCCINT</li> <li>■ VCCO_#</li> <li>■ VCCBRAM</li> <li>n NC</li> </ul>
<b>Multi-Function Pins</b>			
<ul style="list-style-type: none"> <li>B ADV_B</li> <li>B FCS_B</li> <li>B FOE_B</li> <li>B MOSI</li> <li>B FWE_B</li> <li>B DOUT_CSO_B</li> <li>B CSI_B</li> <li>B PUDC_B</li> <li>U RDWR_B</li> <li>r RSO-RS1</li> <li>● AD0P/AD0N-AD15P/AD15N</li> <li>⊖ EMCCLK</li> </ul>	<ul style="list-style-type: none"> <li>⊕ VRN</li> <li>⊗ VREF</li> <li>● D00-D31</li> <li>● A00-A28</li> <li>⊖ DQS</li> <li>● MRCC</li> <li>● SRCC</li> </ul>		

ug475\_c3\_145\_122811

Figure 3-125: FF/FFG1926 Packages—7VX690T and 7VX980T Pinout Diagram

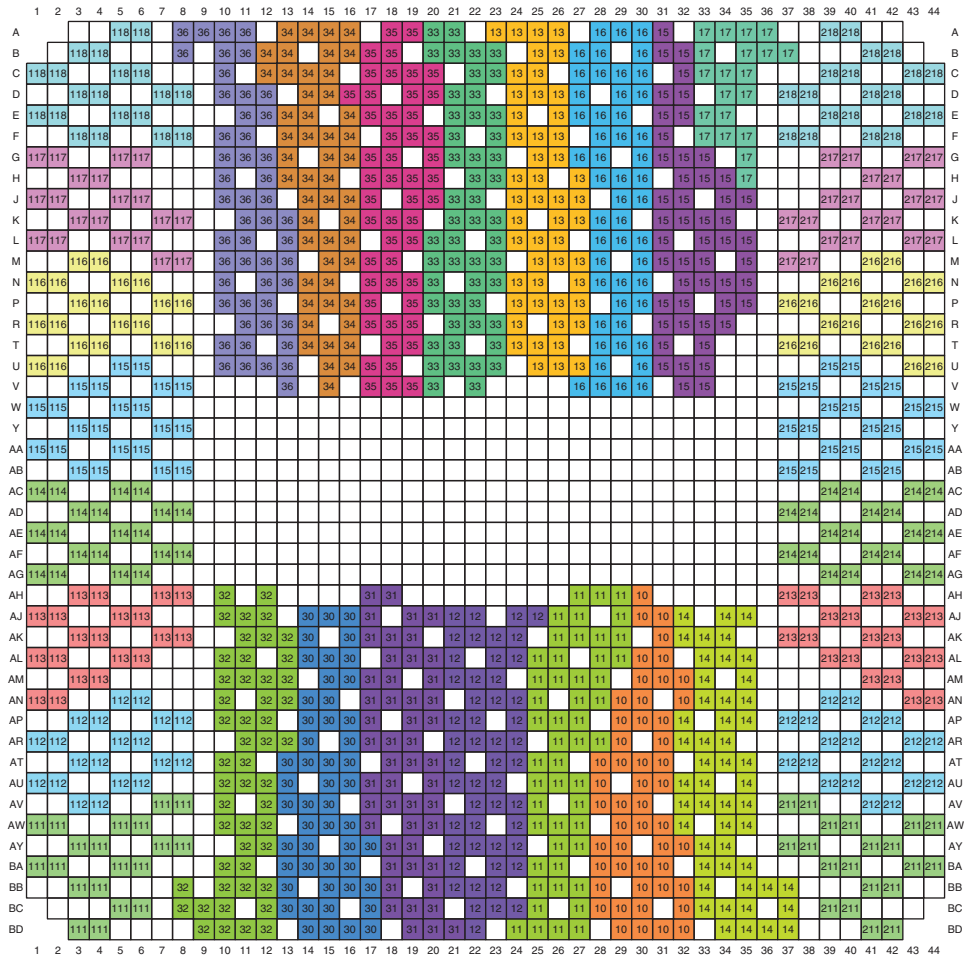

ug475\_c3\_146\_122811

Figure 3-126: FF/FG1926 Packages—7VX690T and 7VX980T I/O Banks

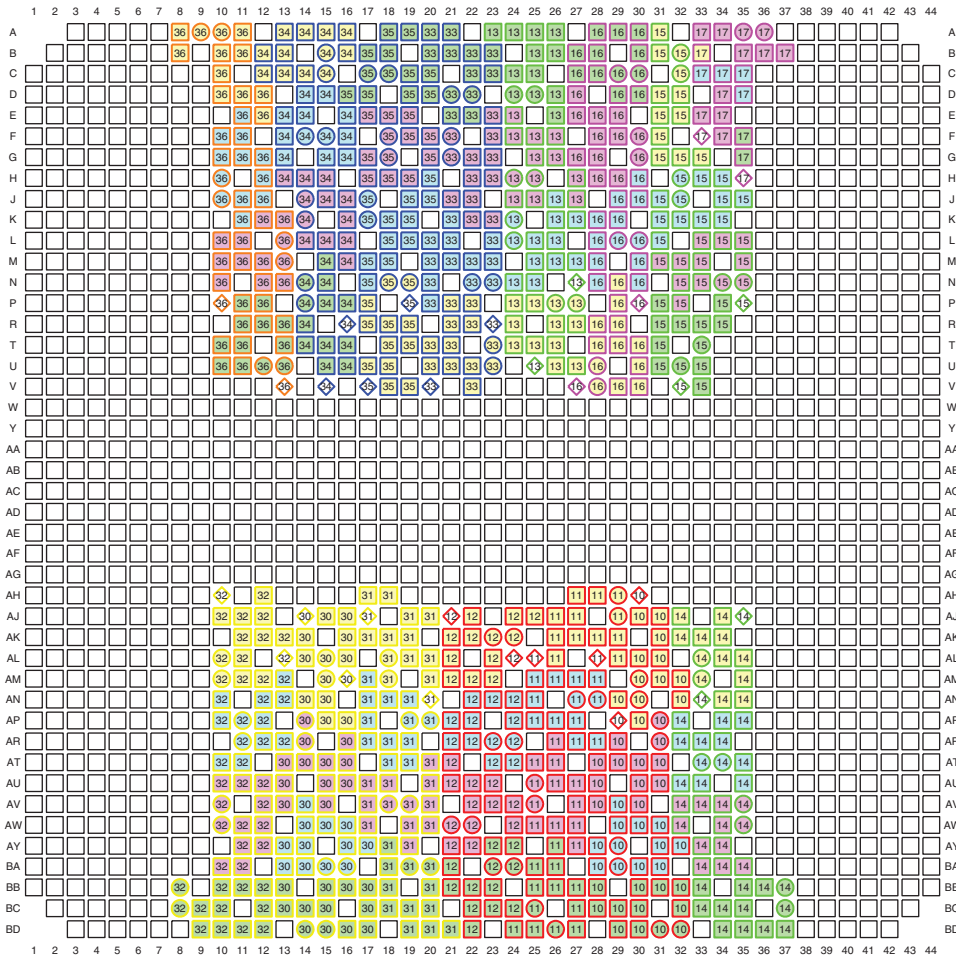

Memory Groupings Pins			
#	HP I/O	#	DQS pin
#	HR I/O	◇	DCI pin
#	HP I/O – VCCAUX Group 0	#	Memory Byte Group 0
#	HP I/O – VCCAUX Group 1	#	Memory Byte Group 1
#	HP I/O – VCCAUX Group 2	#	Memory Byte Group 2
#	HP I/O – VCCAUX Group 3	#	Memory Byte Group 3
#	HP I/O – VCCAUX Group 4	#	Bank Number
#	HP I/O – VCCAUX Group 5		
#	HP I/O – VCCAUX Group 6		
#	HP I/O – VCCAUX Group 7		

ug475\_c3\_147\_122811

Figure 3-127: FF/FFG1926 Packages—7VX690T and 7VX980T Memory Groupings

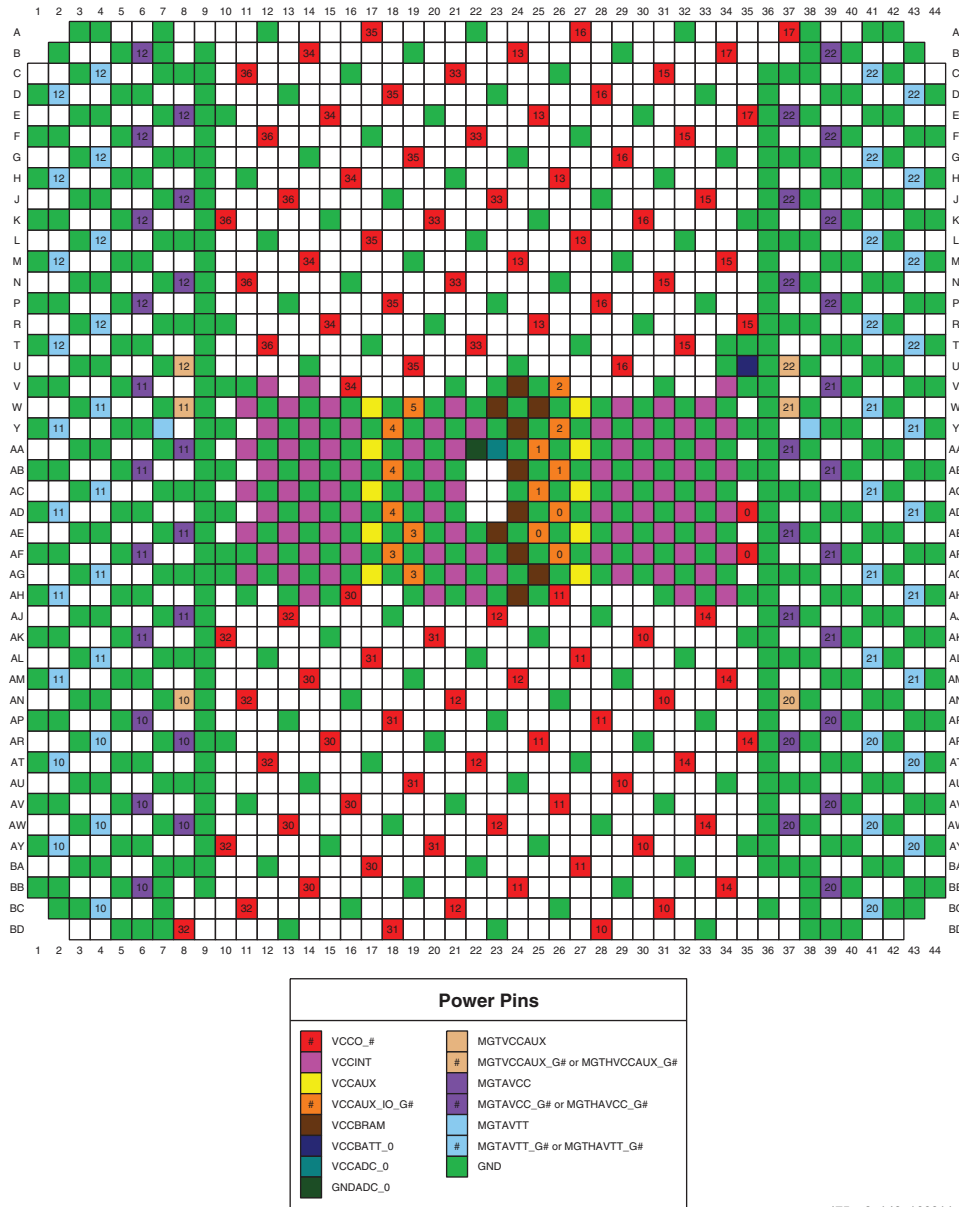

ug475\_c3\_148\_122811

Figure 3-128: FF/FG1926 Packages—7VX690T and 7VX980T Power and GND Placement

## FF/FFG1927 Packages—7VX550T and 7VX690T

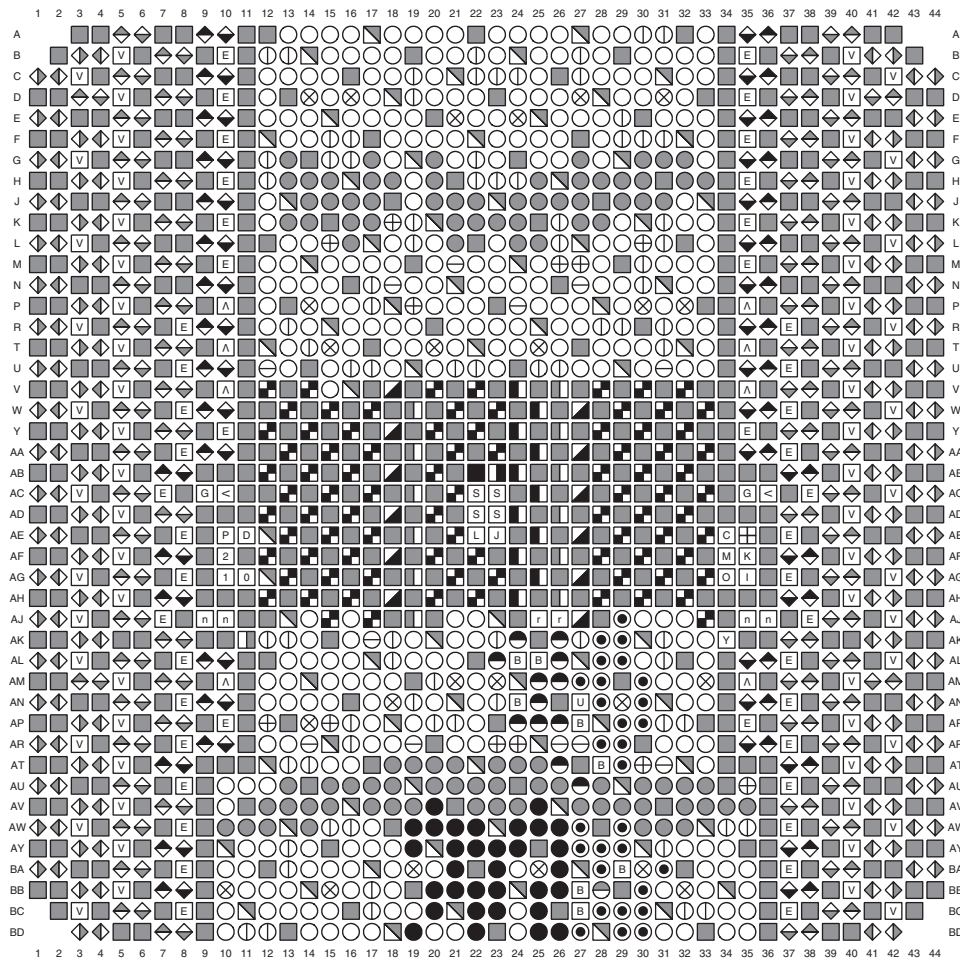

User I/O Pins	Transceiver Pins	Dedicated Pins	Other Pins
<ul style="list-style-type: none"> <li>○ IO_LXXY_#</li> <li>◻ IO_XX_#</li> </ul>	<ul style="list-style-type: none"> <li>◻ MGTAVCC_G#</li> <li>◻ MGTAVTT_G#</li> <li>◻ MGTVCCAUX_G#</li> <li>◻ MGTAVTTRCAL</li> <li>◻ MGTTRREF</li> <li>◻ MGTREFCLK1/0P</li> <li>◻ MGTREFCLK1/0N</li> <li>◻ MGTXRXP</li> <li>◻ MGTXRXN</li> <li>◻ MGXTXTP</li> <li>◻ MGXTTXN</li> <li>◻ MGTHAVCC_G#</li> <li>◻ MGTHAVTT_G#</li> <li>◻ MGTHRXP</li> <li>◻ MGTHRNX</li> <li>◻ MGHTXTP</li> <li>◻ MGHTTXN</li> </ul>	<ul style="list-style-type: none"> <li>◻ CCLK_0</li> <li>◻ CFGBVS_0</li> <li>◻ DONE_0</li> <li>◻ DXP_0</li> <li>◻ DXN_0</li> <li>◻ GNDADC_0</li> <li>◻ INIT_B_0</li> <li>◻ M0_0</li> <li>◻ M1_0</li> <li>◻ M2_0</li> <li>◻ PROGRAM_B_0</li> <li>◻ TCK_0</li> <li>◻ TDI_0</li> <li>◻ TDO_0</li> <li>◻ TMS_0</li> <li>◻ VCCADC_0</li> <li>◻ VCCBATT_0</li> <li>◻ VP_0</li> <li>◻ VN_0</li> <li>◻ VREFP_0</li> <li>◻ VREFN_0</li> </ul>	<ul style="list-style-type: none"> <li>◻ GND</li> <li>◻ VCCAUX_IO_G#</li> <li>◻ VCCAUX</li> <li>◻ VCCINT</li> <li>◻ VCCO_#</li> <li>◻ VCCBRAM</li> <li>◻ NC</li> </ul>
<b>Multi-Function Pins</b>			
<ul style="list-style-type: none"> <li>◻ ADV_B</li> <li>◻ FCS_B</li> <li>◻ FOE_B</li> <li>◻ MOSI</li> <li>◻ FWE_B</li> <li>◻ DOUT_CSO_B</li> <li>◻ CSI_B</li> <li>◻ PUDC_B</li> <li>◻ RDWR_B</li> <li>◻ RSO-RS1</li> <li>◻ AD0P/AD0N--AD15P/AD15N</li> <li>◻ EMCCLK</li> <li>⊕ VRN</li> <li>⊖ VRP</li> <li>⊗ VREF</li> <li>◻ D00--D31</li> <li>◻ A00--A28</li> <li>⊕ DOS</li> <li>◻ MRCC</li> <li>◻ SRCC</li> </ul>			

ug475\_c3\_149\_122811

Figure 3-129: FF/FFG1927 Packages—7VX550T and 7VX690T Pinout Diagram





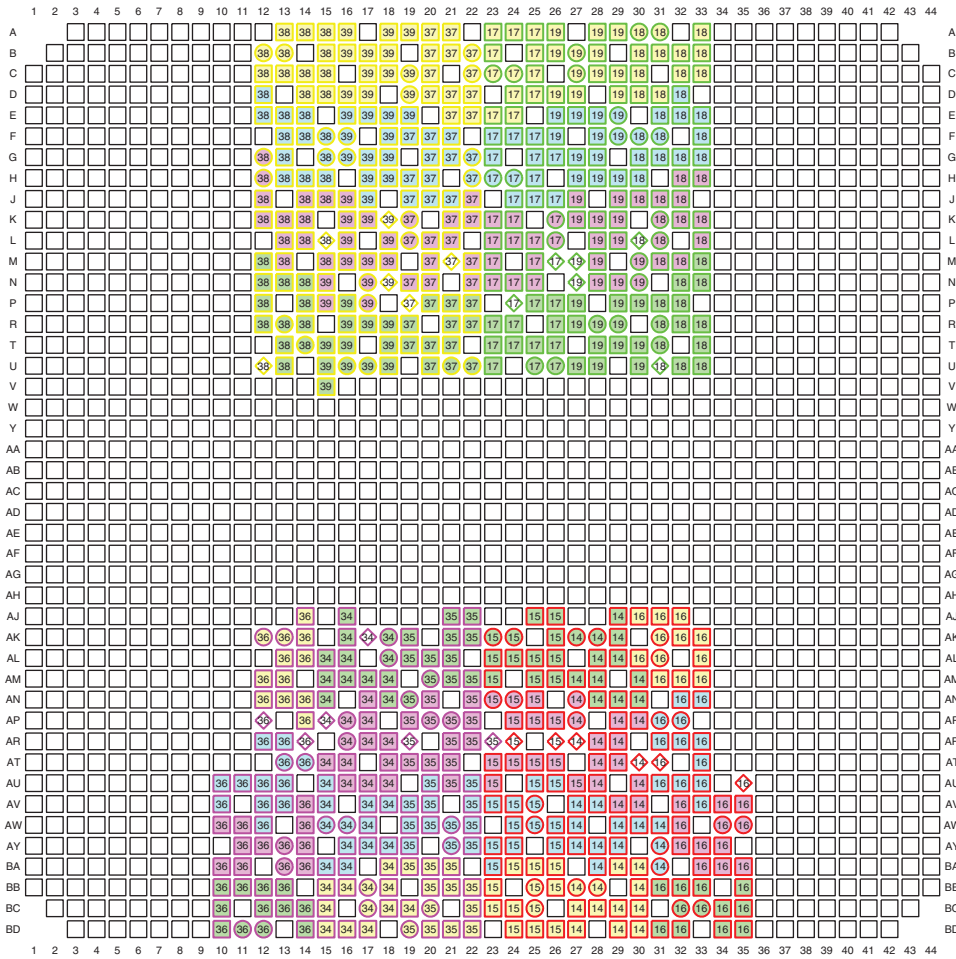

Memory Groupings Pins			
#	HP I/O	#	DQS pin
#	HR I/O	◇	DCI pin
#	HP I/O – VCCAUX Group 0	#	Memory Byte Group 0
#	HP I/O – VCCAUX Group 1	#	Memory Byte Group 1
#	HP I/O – VCCAUX Group 2	#	Memory Byte Group 2
#	HP I/O – VCCAUX Group 3	#	Memory Byte Group 3
#	HP I/O – VCCAUX Group 4	#	Bank Number
#	HP I/O – VCCAUX Group 5		
#	HP I/O – VCCAUX Group 6		
#	HP I/O – VCCAUX Group 7		

ug475\_c3\_151\_122811

Figure 3-131: FF/FFG1927 Packages—7VX550T and 7VX690T Memory Groupings

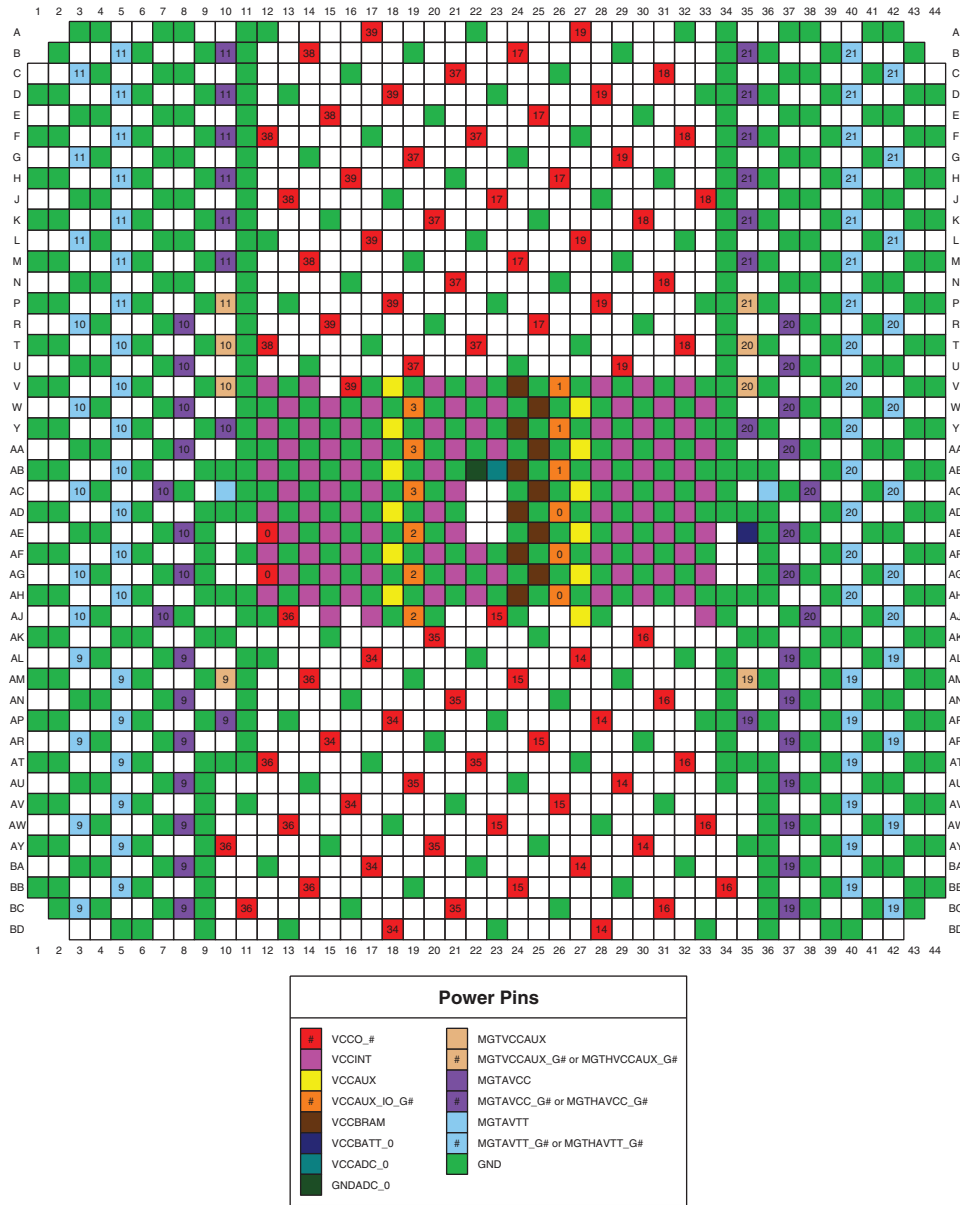

ug475\_c3\_152\_122811

Figure 3-132: FF/FG1927 Packages—7VX550T and 7VX690T Power and GND Placement

## FF/FFG1930 and RF1930 Packages—7VX690T

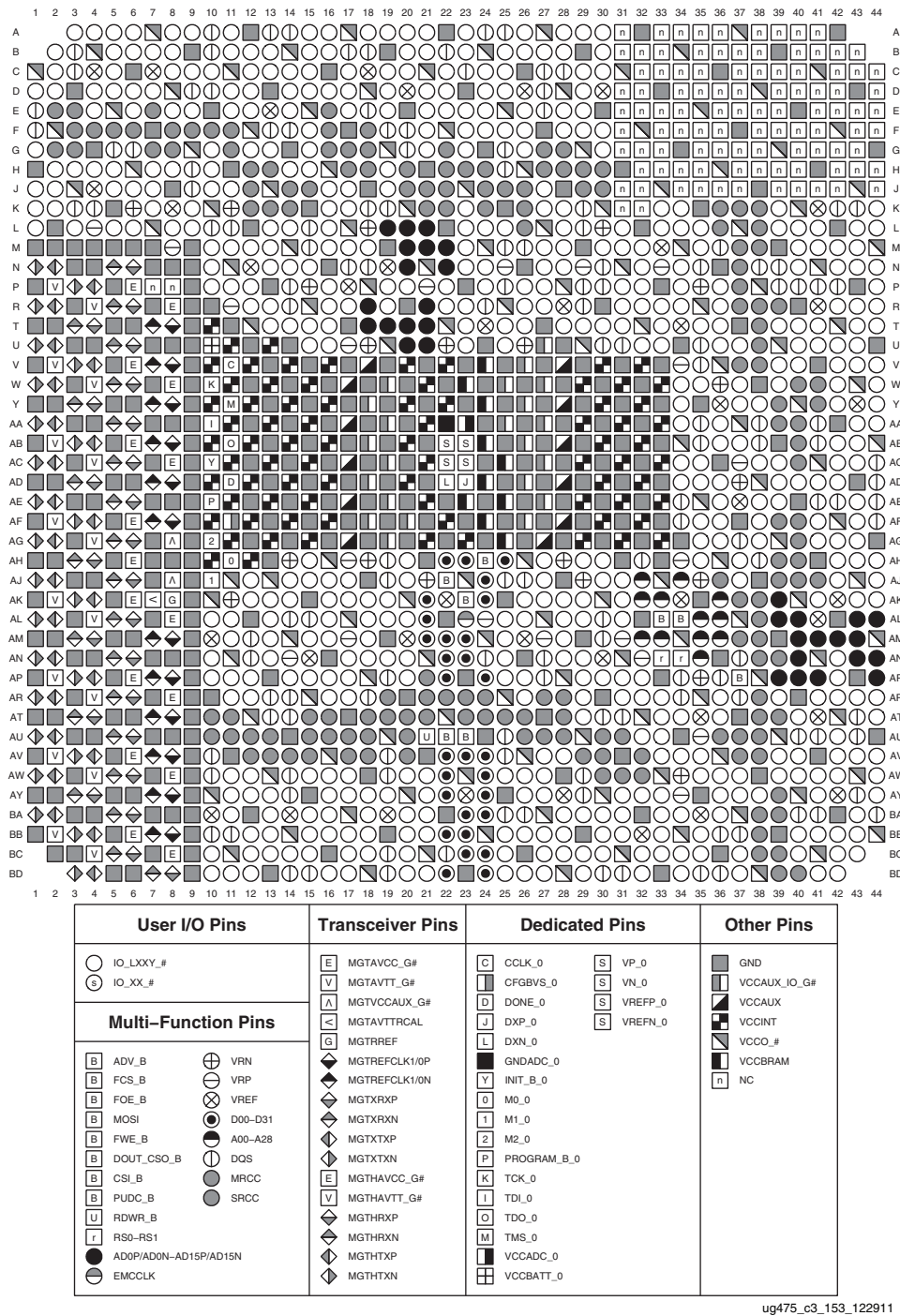

Figure 3-133: FF/FFG1930 and RF1930 Packages—7VX690T Pinout Diagram



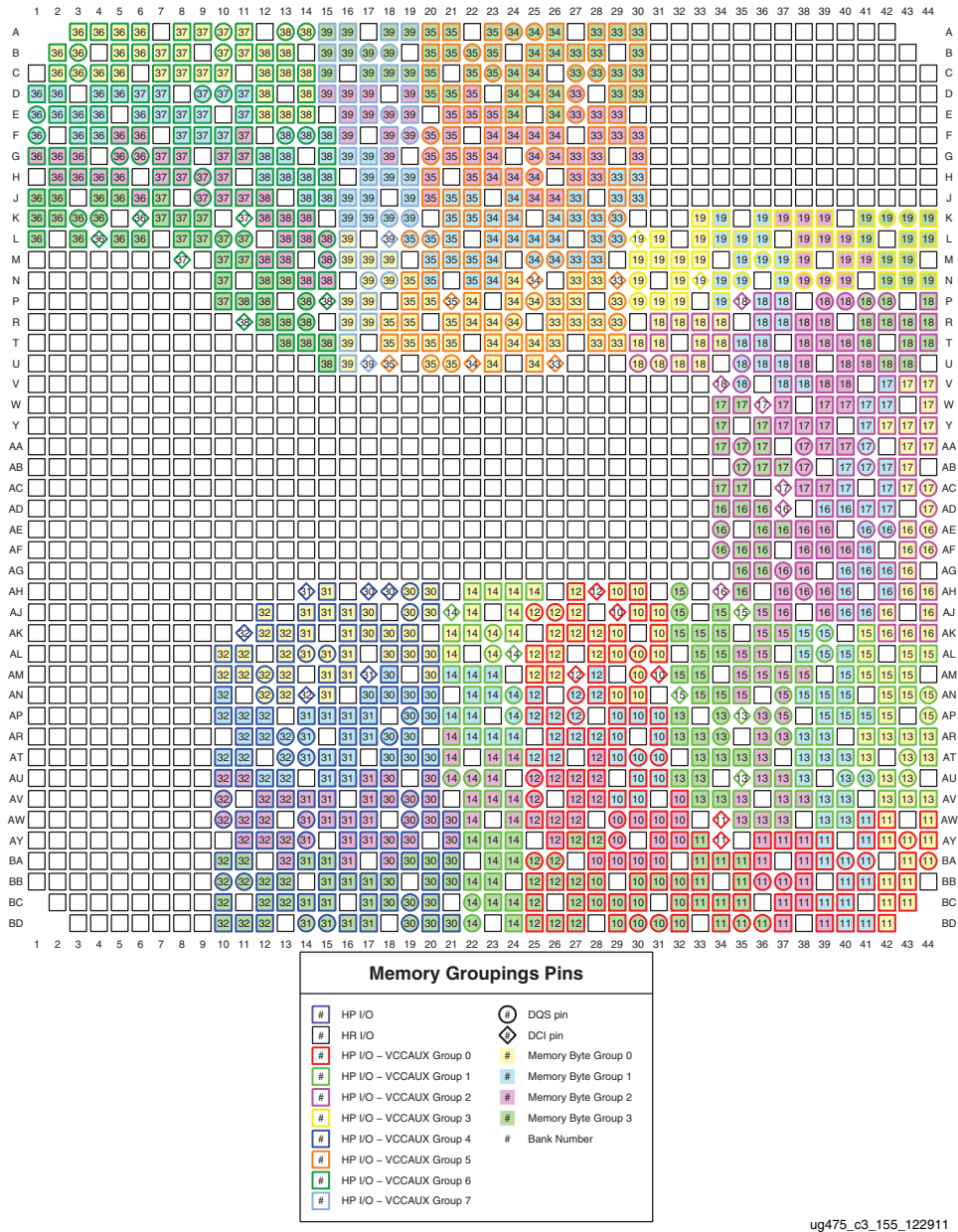
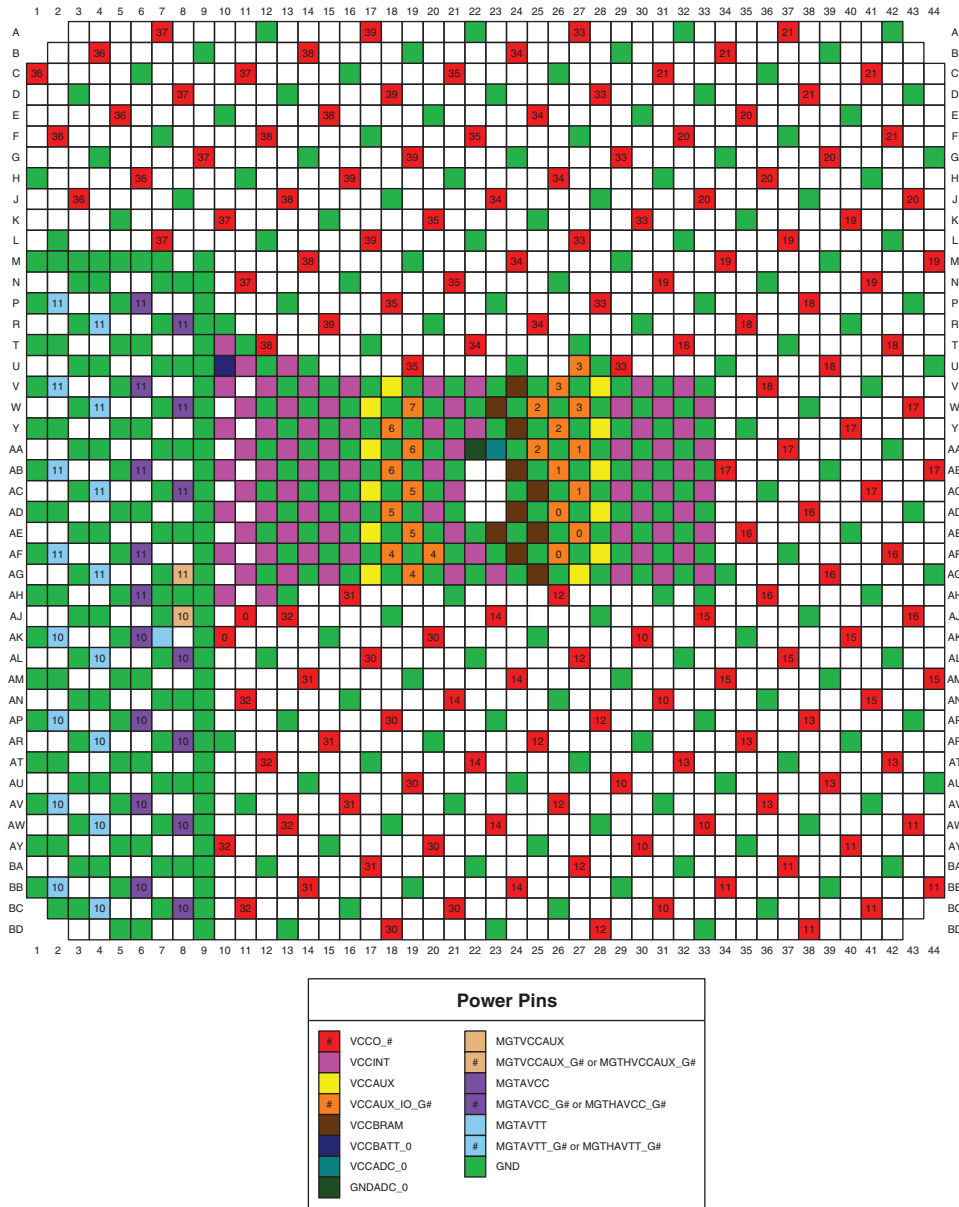

Figure 3-135: FF/FFG1930 and RF1930 Packages—7VX690T Memory Groupings



ug475\_c3\_156\_122911

Figure 3-136: FF/FFG1930 and RF1930 Packages—7VX690T Power and GND Placement

### FF/FFG1928 Packages—7VX980T

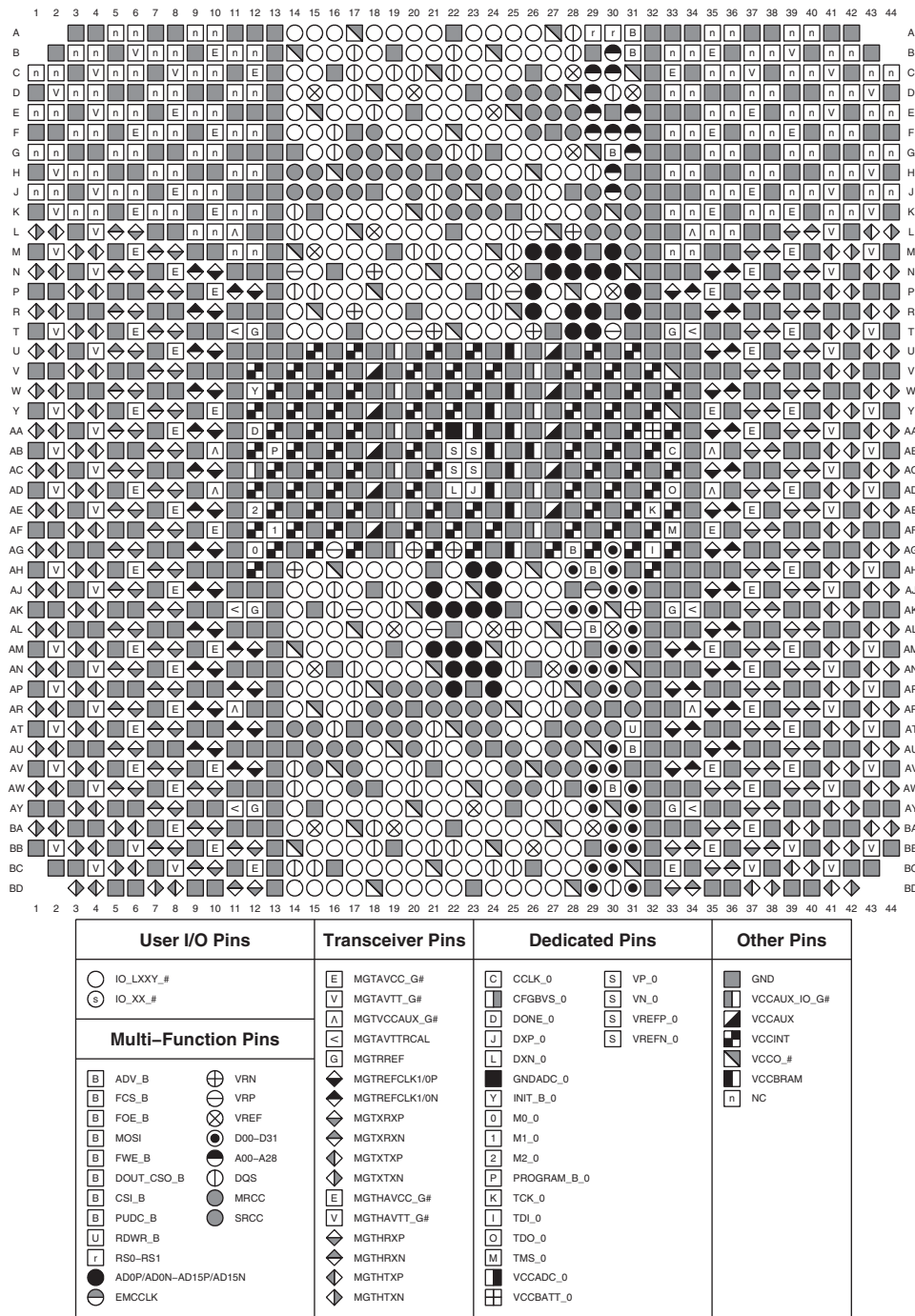

ug475\_c3\_157\_122911

Figure 3-137: FF/FFG1928 Packages—7VX980T Pinout Diagram





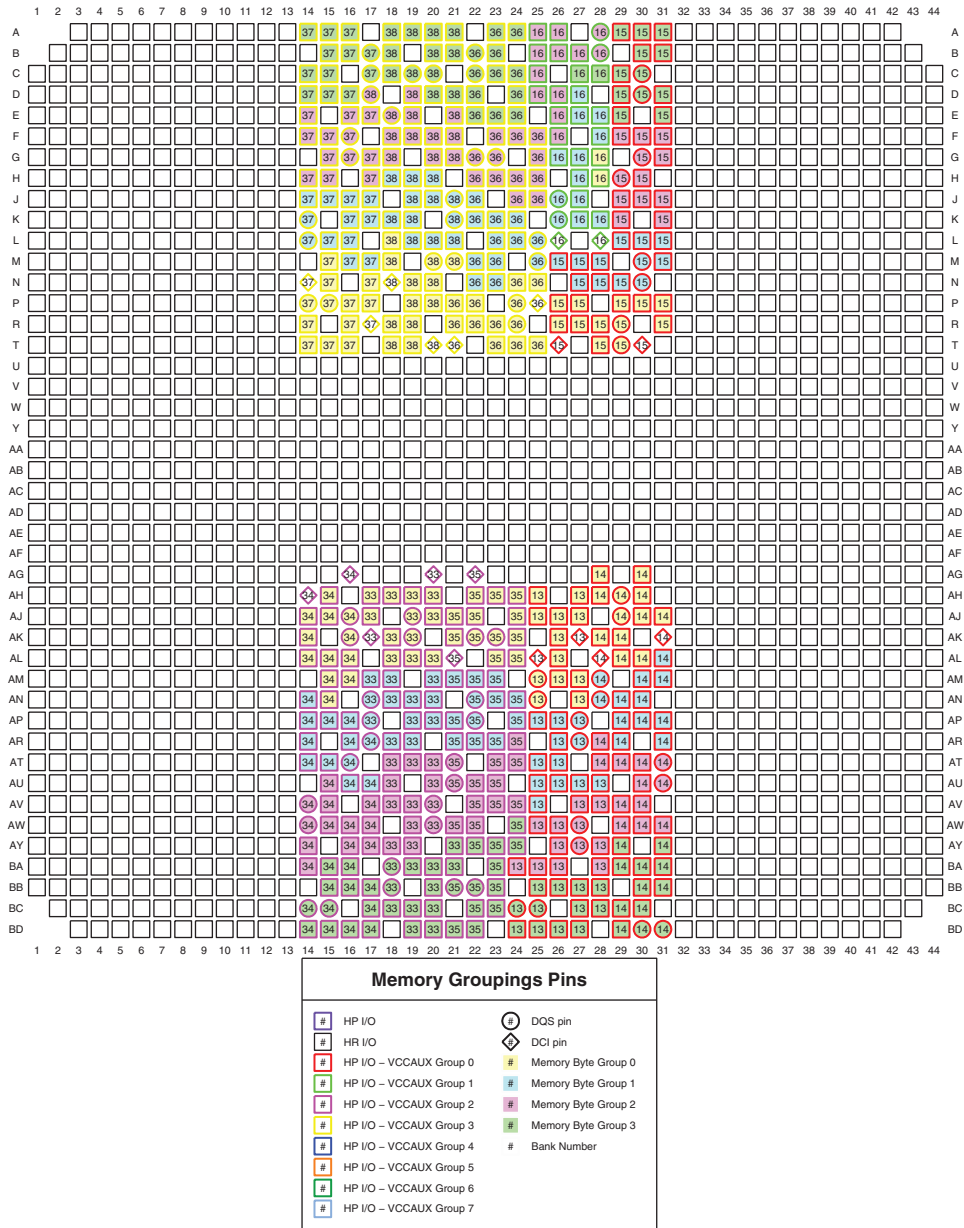

Figure 3-139: FF/FFG1928 Packages—7VX980T Memory Groupings

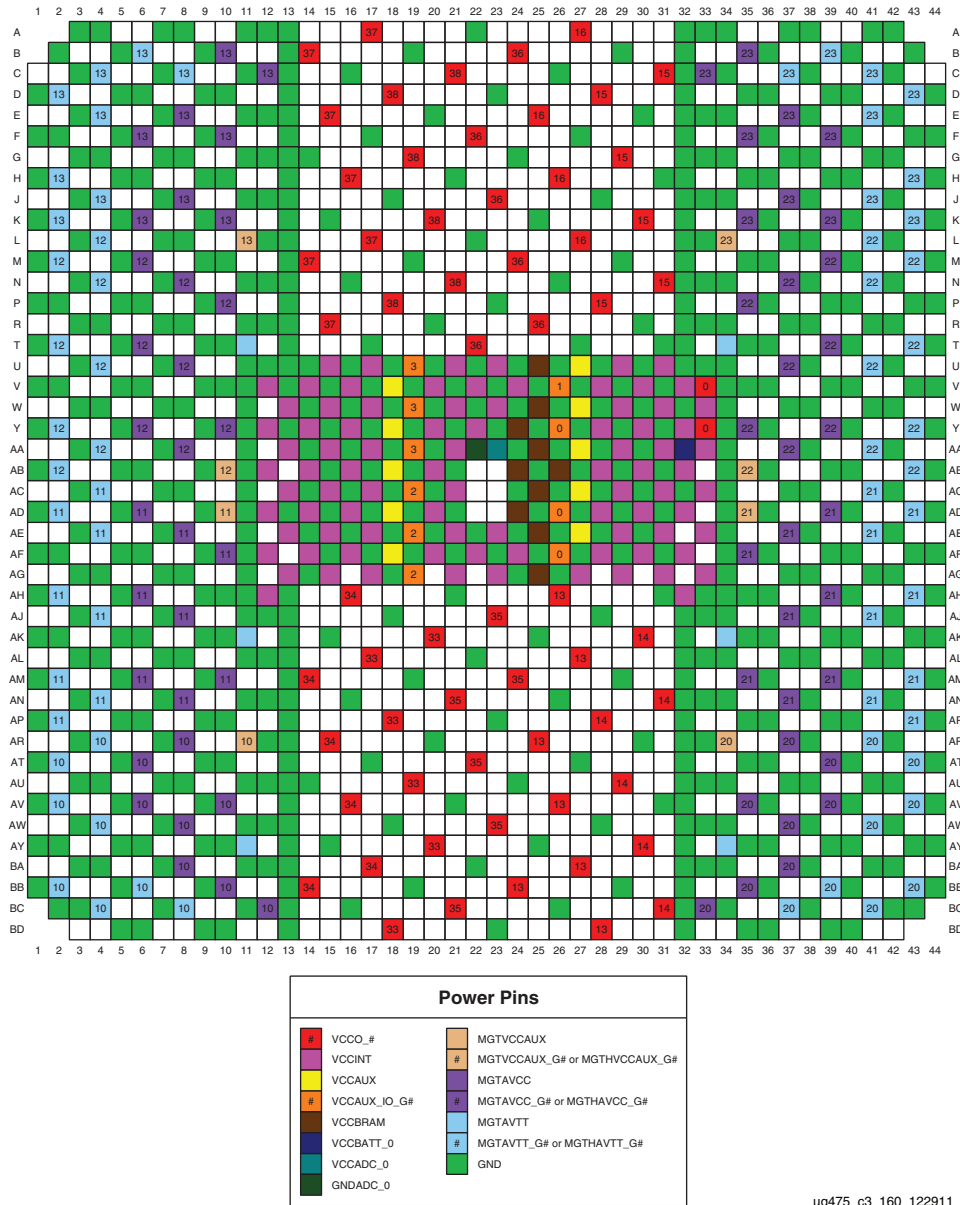

Figure 3-140: FF/FFG1928 Packages—7VX980T Power and GND Placement

## FF/FFG1930 and RF1930 Packages—7VX980T

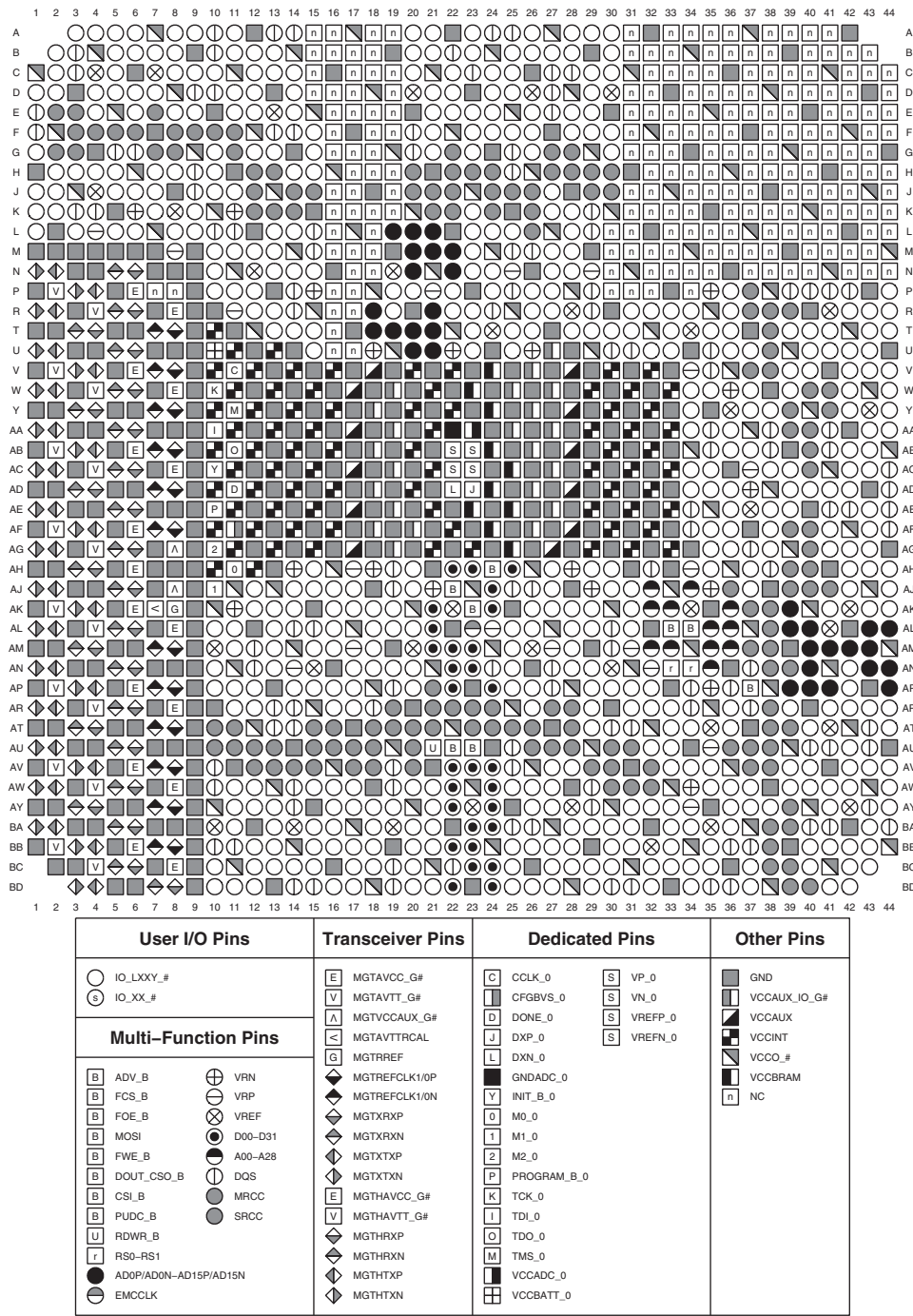

Figure 3-141: FF/FFG1930 and RF1930 Packages—7VX980T Pinout Diagram



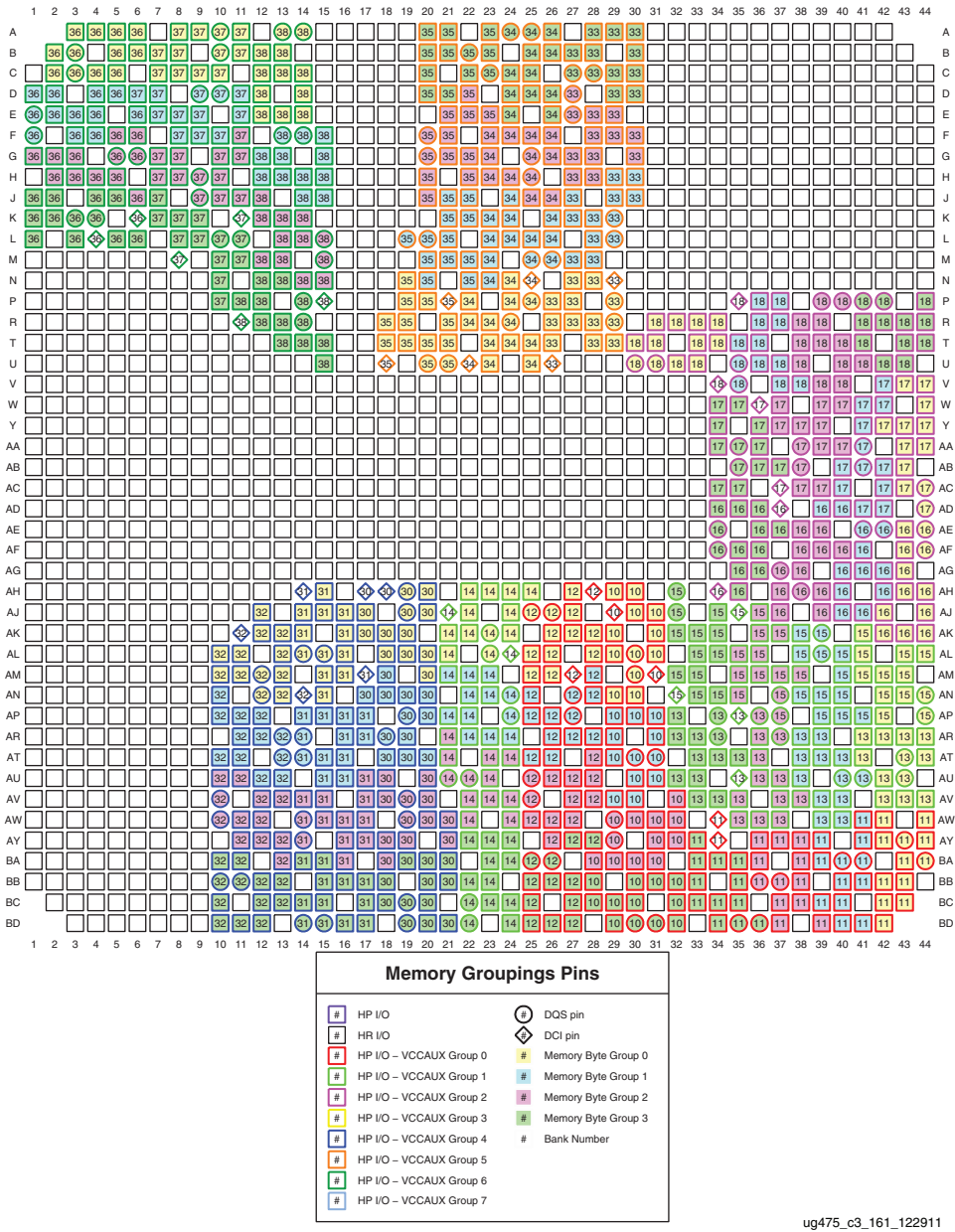

Figure 3-143: FF/FFG1930 and RF1930 Packages—7VX980T Memory Groupings

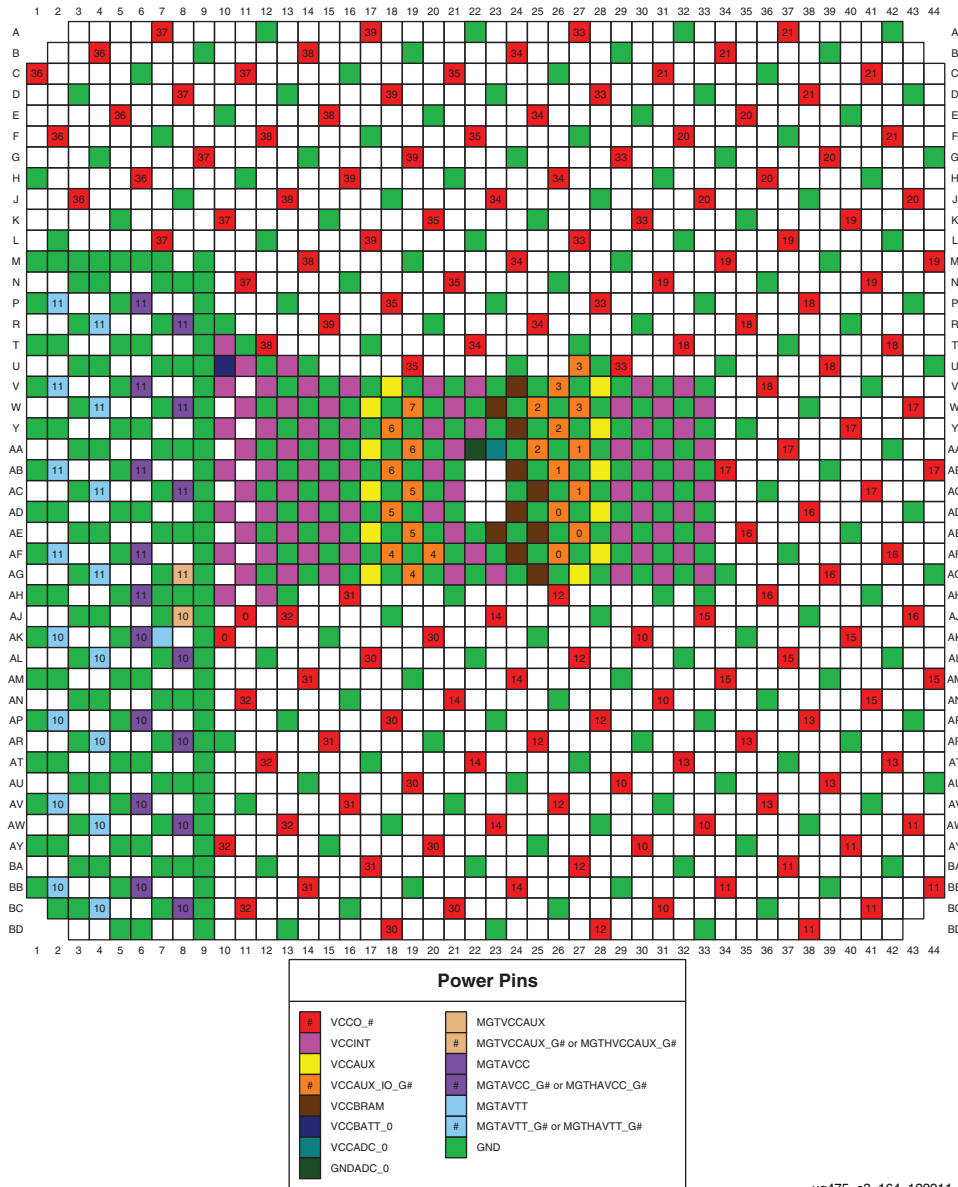
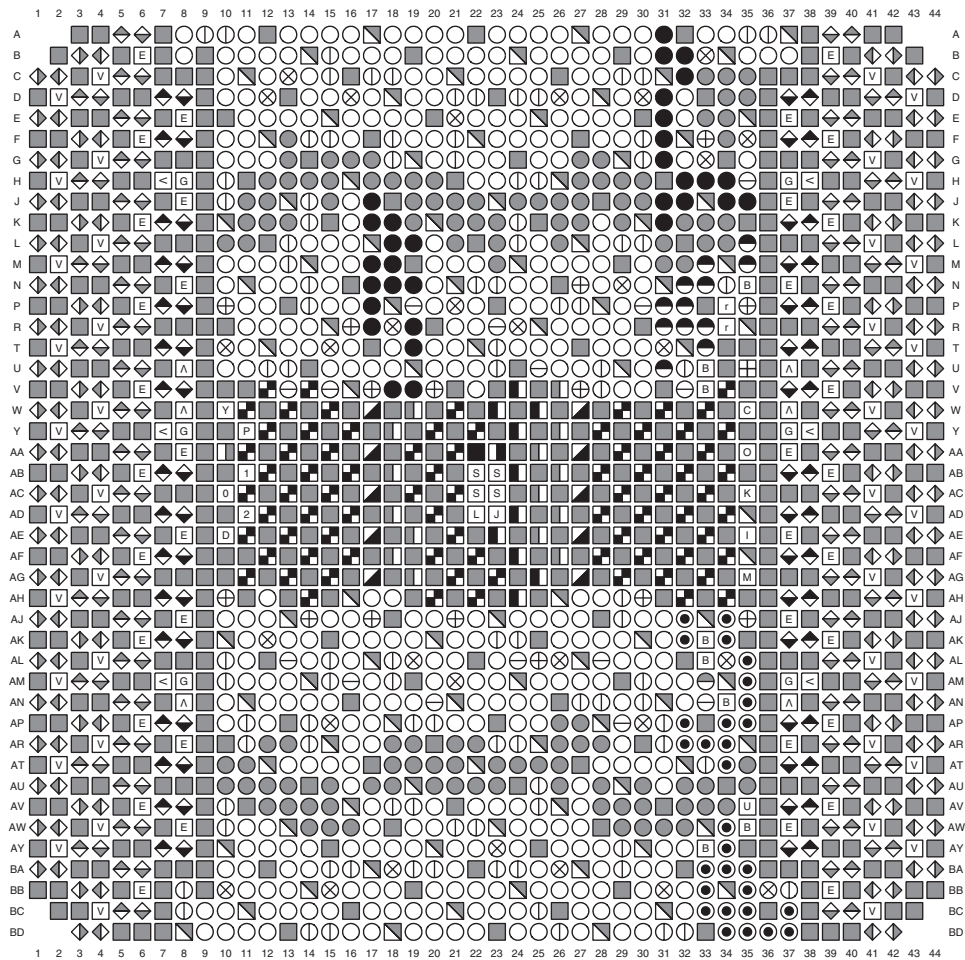

Figure 3-144: FF/FG1930 and RF1930 Packages—7VX980T Power and GND Placement

### FL/FLG1926 Packages—7VX1140T



User I/O Pins	Transceiver Pins	Dedicated Pins	Other Pins
<ul style="list-style-type: none"> <li>○ IO_LXXY_#</li> <li>○ IO_XX_#</li> </ul>	<ul style="list-style-type: none"> <li>E MGTAVCC_G#</li> <li>V MGTAVTT_G#</li> <li>A MGTAVCCAUX_G#</li> <li>&lt; MGTAVTTRCAL</li> <li>G MGTTRREF</li> <li>◆ MGTREFCLK1/0P</li> <li>◆ MGTREFCLK1/0N</li> <li>◆ MGTXRXP</li> <li>◆ MGTXRNX</li> <li>◆ MGTXTXP</li> <li>◆ MGTXTXN</li> <li>E MGTHAVCC_G#</li> <li>V MGTHAVTT_G#</li> <li>◆ MGTTHRX</li> <li>◆ MGTHTXP</li> <li>◆ MGTHTXN</li> </ul>	<ul style="list-style-type: none"> <li>C CCLK_0</li> <li>I CFGBVS_0</li> <li>D DONE_0</li> <li>J DXP_0</li> <li>L DXN_0</li> <li>■ GNDADC</li> <li>Y INIT_B_0</li> <li>0 M0_0</li> <li>1 M1_0</li> <li>2 M2_0</li> <li>P PROGRAM_B_0</li> <li>K TCK_0</li> <li>I TDI_0</li> <li>0 TDO_0</li> <li>M TMS_0</li> <li>■ VCCADC</li> <li>■ VCCBATT_0</li> </ul>	<ul style="list-style-type: none"> <li>S VP_0</li> <li>S VN_0</li> <li>S VREFP_0</li> <li>S VREFN_0</li> <li>■ GND</li> <li>■ VCCAUX_IO_G#</li> <li>■ VCCAUX</li> <li>■ VCCINT</li> <li>■ VCCO_#</li> <li>■ VCCBRAM</li> <li>n NC</li> </ul>
<b>Multi-Function Pins</b>			
<ul style="list-style-type: none"> <li>B ADV_B</li> <li>B FCS_B</li> <li>B FOE_B</li> <li>B MOSI</li> <li>B FWE_B</li> <li>B DOUT_CSO_B</li> <li>B CSI_B</li> <li>B PUDC_B</li> <li>U RDWR_B</li> <li>7 RS0-RS1</li> <li>● AD0P/AD0N-AD15P/AD15N</li> <li>○ EMCCLK</li> </ul>	<ul style="list-style-type: none"> <li>⊕ VRN</li> <li>⊖ VRP</li> <li>⊗ VREF</li> <li>● D00-D31</li> <li>● A00-A28</li> <li>⊖ DQS</li> <li>● MRCC</li> <li>● SRCC</li> </ul>		

ug475\_c3\_165\_101413

Figure 3-145: FL/FLG1926 Packages—7VX1140T Pinout Diagram

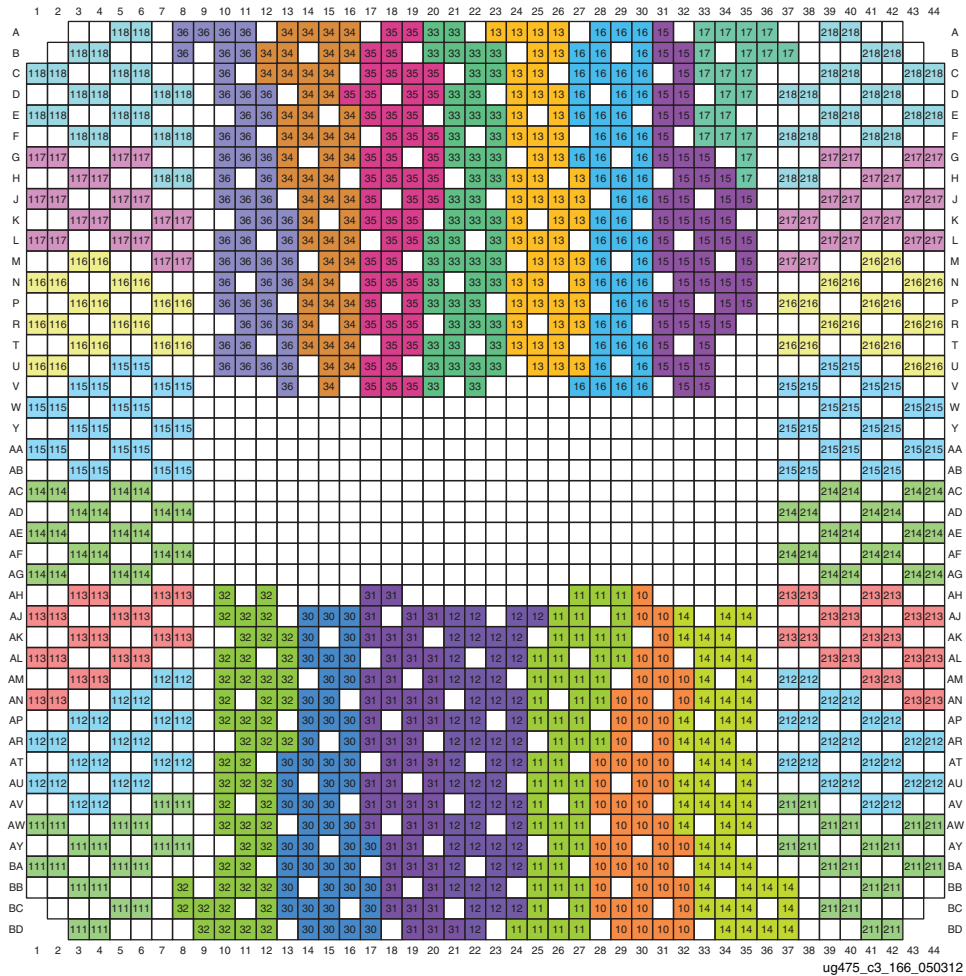
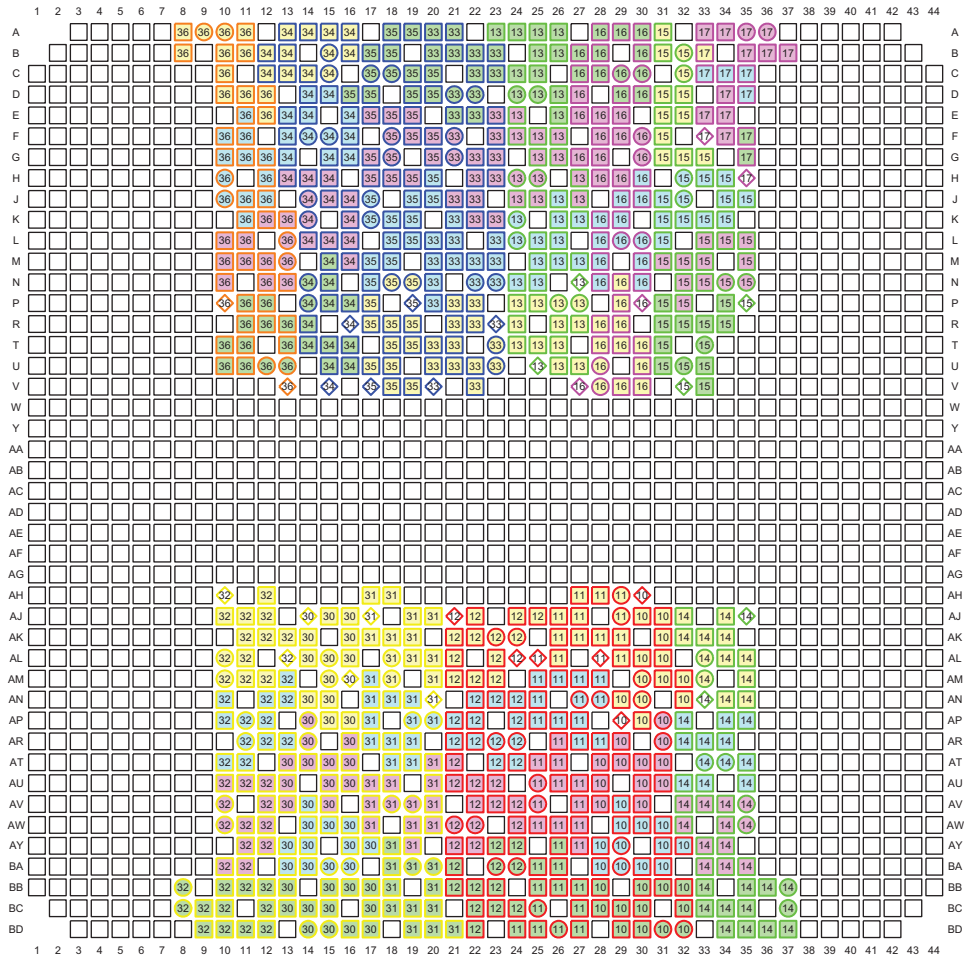

Figure 3-146: FL/FLG1926 Packages—7VX1140T I/O Banks





Memory Groupings Pins			
#	HP I/O	⊕	DQS pin
#	HR I/O	⊖	DCI pin
#	HP I/O – VCCAUX Group 0	#	Memory Byte Group 0
#	HP I/O – VCCAUX Group 1	#	Memory Byte Group 1
#	HP I/O – VCCAUX Group 2	#	Memory Byte Group 2
#	HP I/O – VCCAUX Group 3	#	Memory Byte Group 3
#	HP I/O – VCCAUX Group 4	#	Bank Number
#	HP I/O – VCCAUX Group 5		
#	HP I/O – VCCAUX Group 6		
#	HP I/O – VCCAUX Group 7		

ug475\_c3\_167\_050312

Figure 3-147: FL/FLG1926 Packages—7VX1140T Memory Groupings

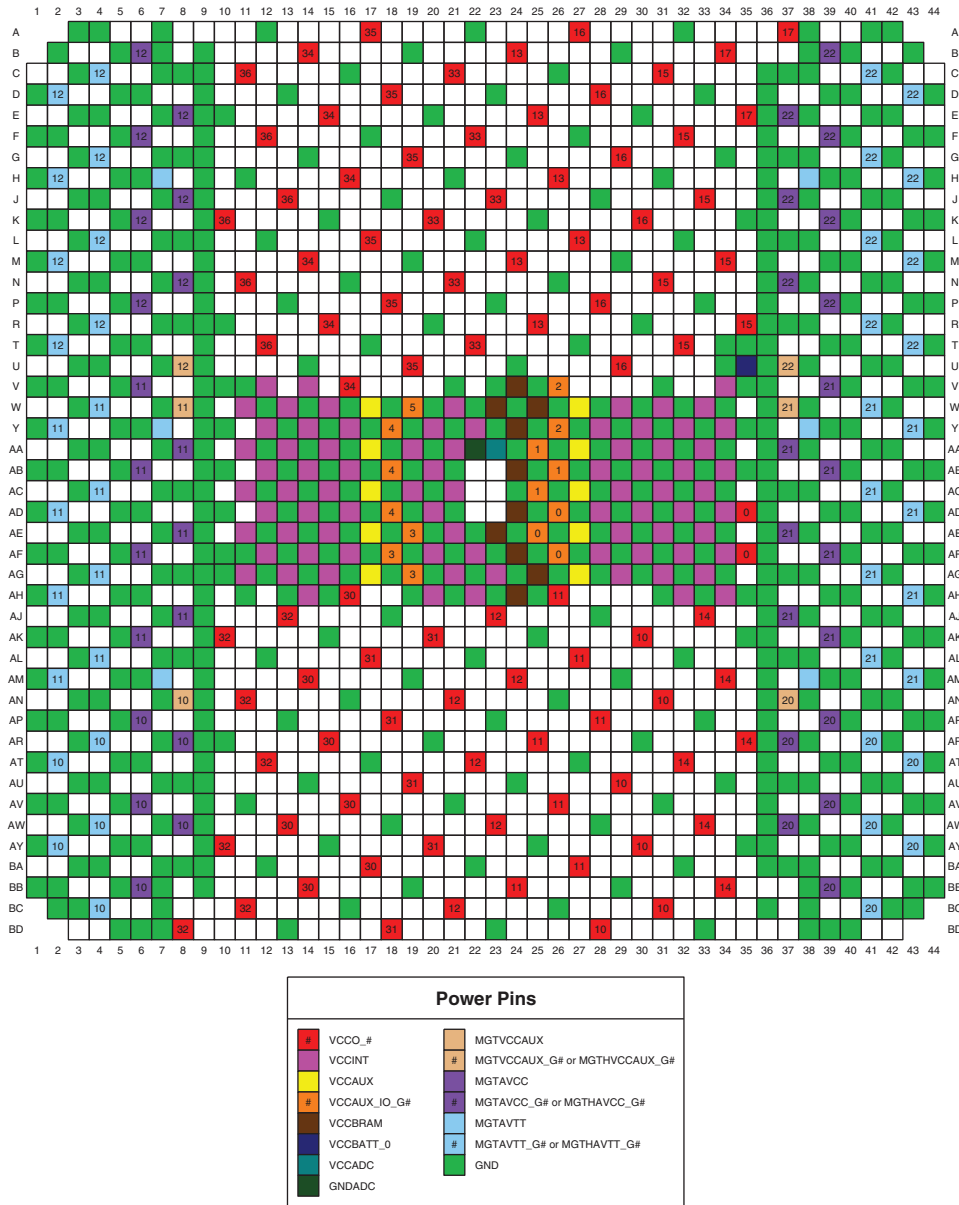
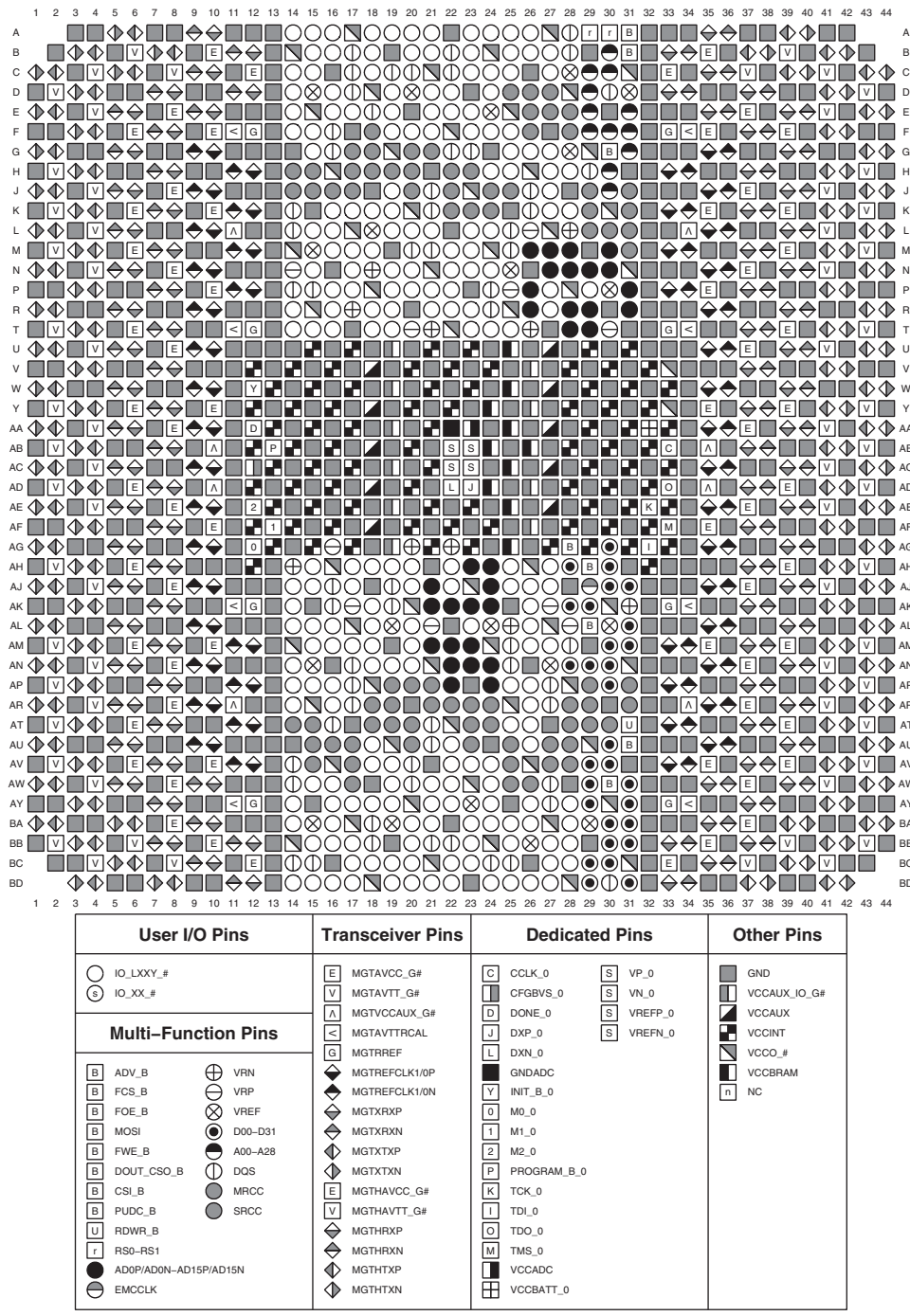

Figure 3-148: FL/FLG1926 Packages—7VX1140T Power and GND Placement

## FL/FLG1928 Packages—7VX1140T



ug475\_c3\_169\_101413

Figure 3-149: FL/FLG1928 Packages—7VX1140T Pinout Diagram

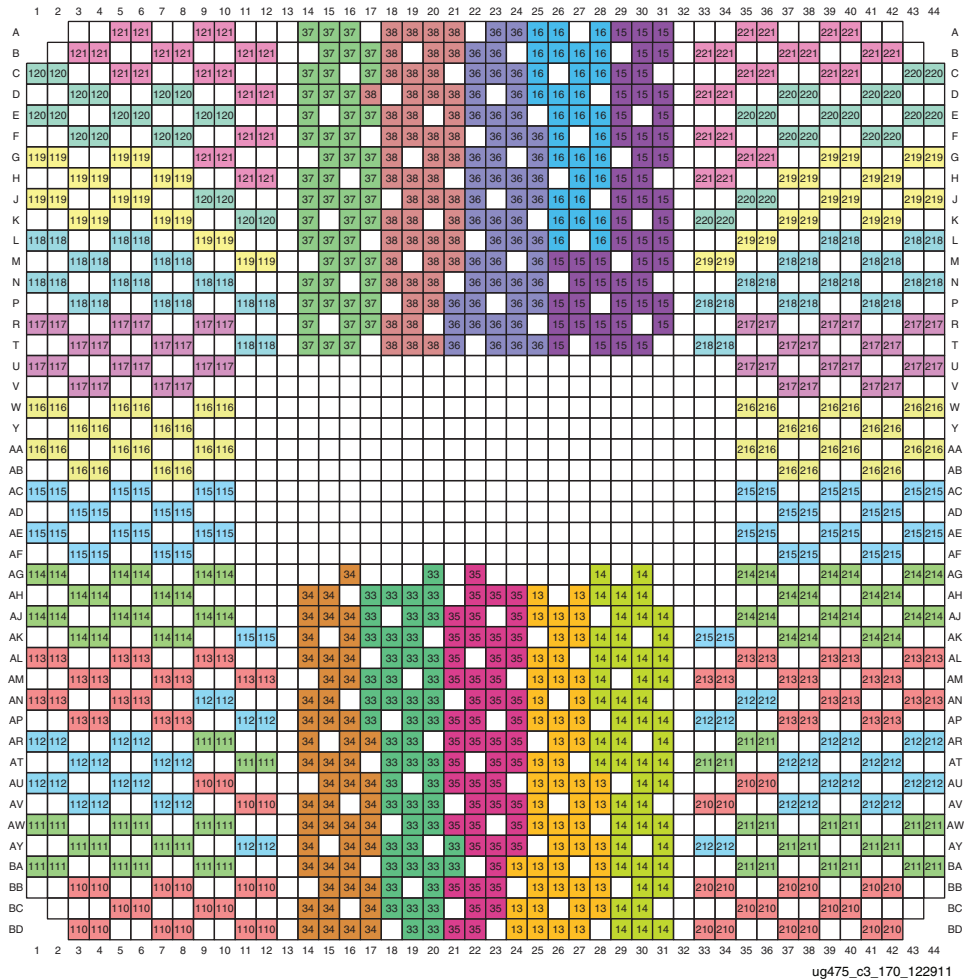
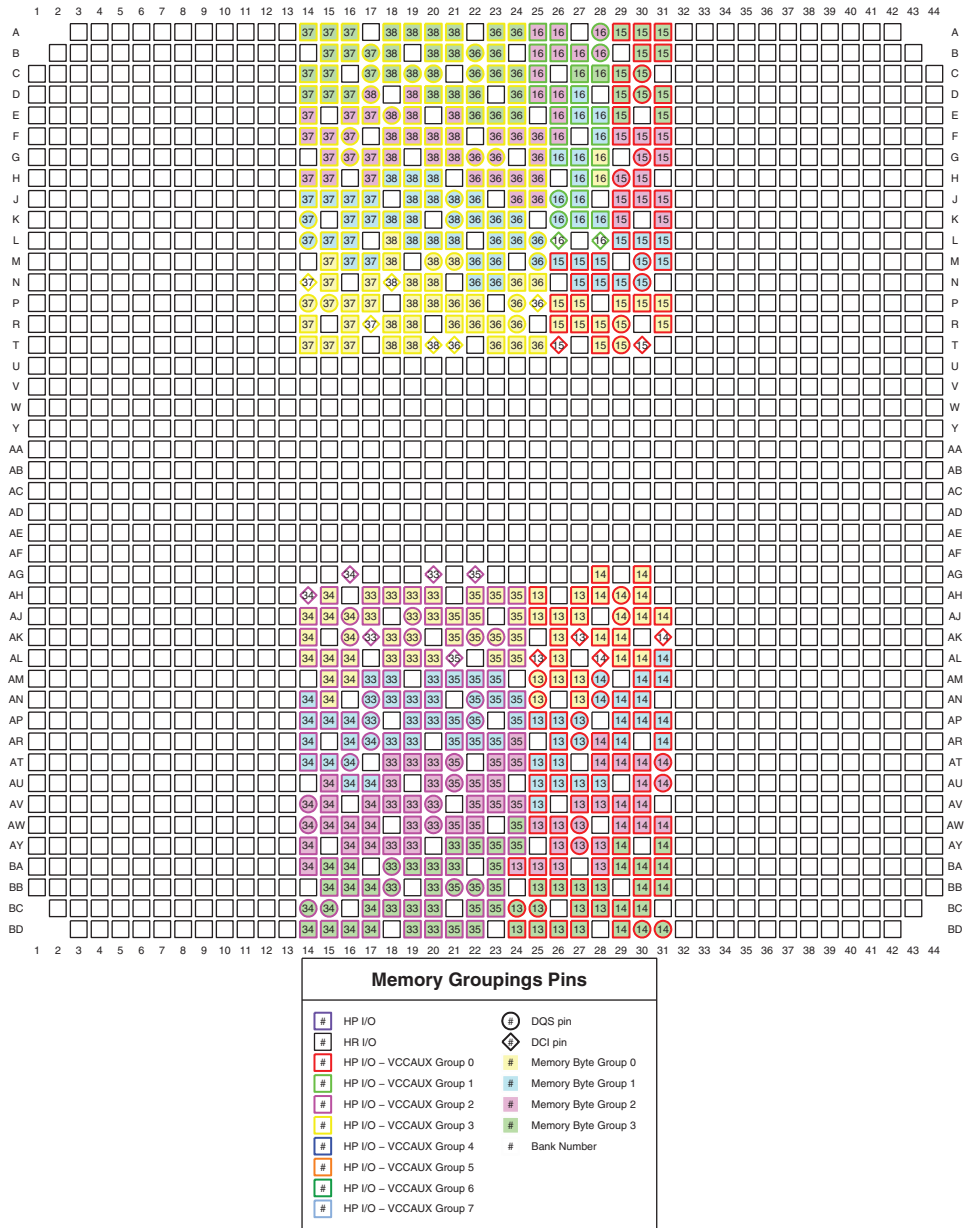
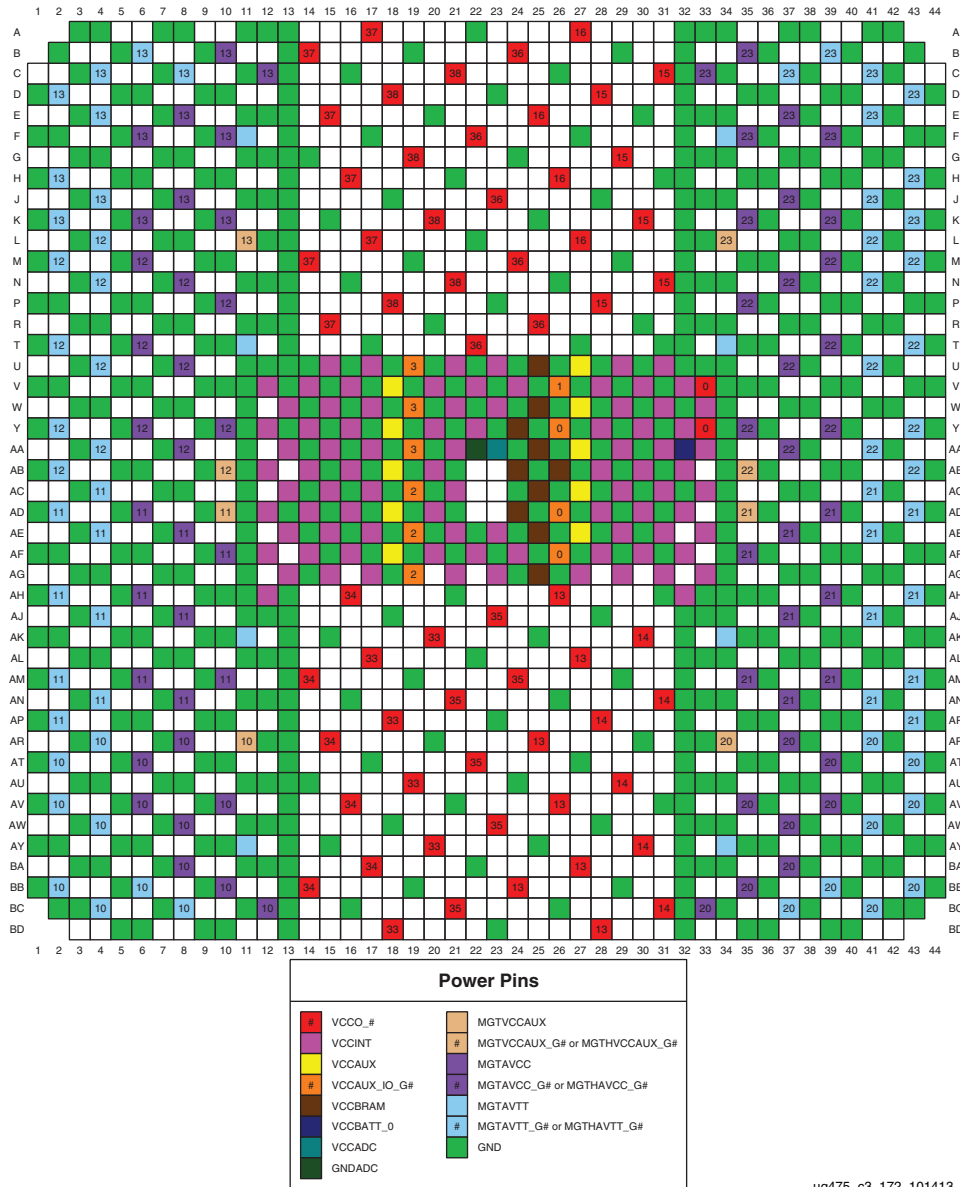

Figure 3-150: FL/FLG1928 Packages—7VX1140T I/O Banks



ug475\_c3\_171\_122911

Figure 3-151: FL/FLG1928 Packages—7VX1140T Memory Groupings



ug475\_c3\_172\_101413

Figure 3-152: FL/FLG1928 Packages—7VX1140T Power and GND Placement

### FL/FLG1930 Packages—7VX1140T

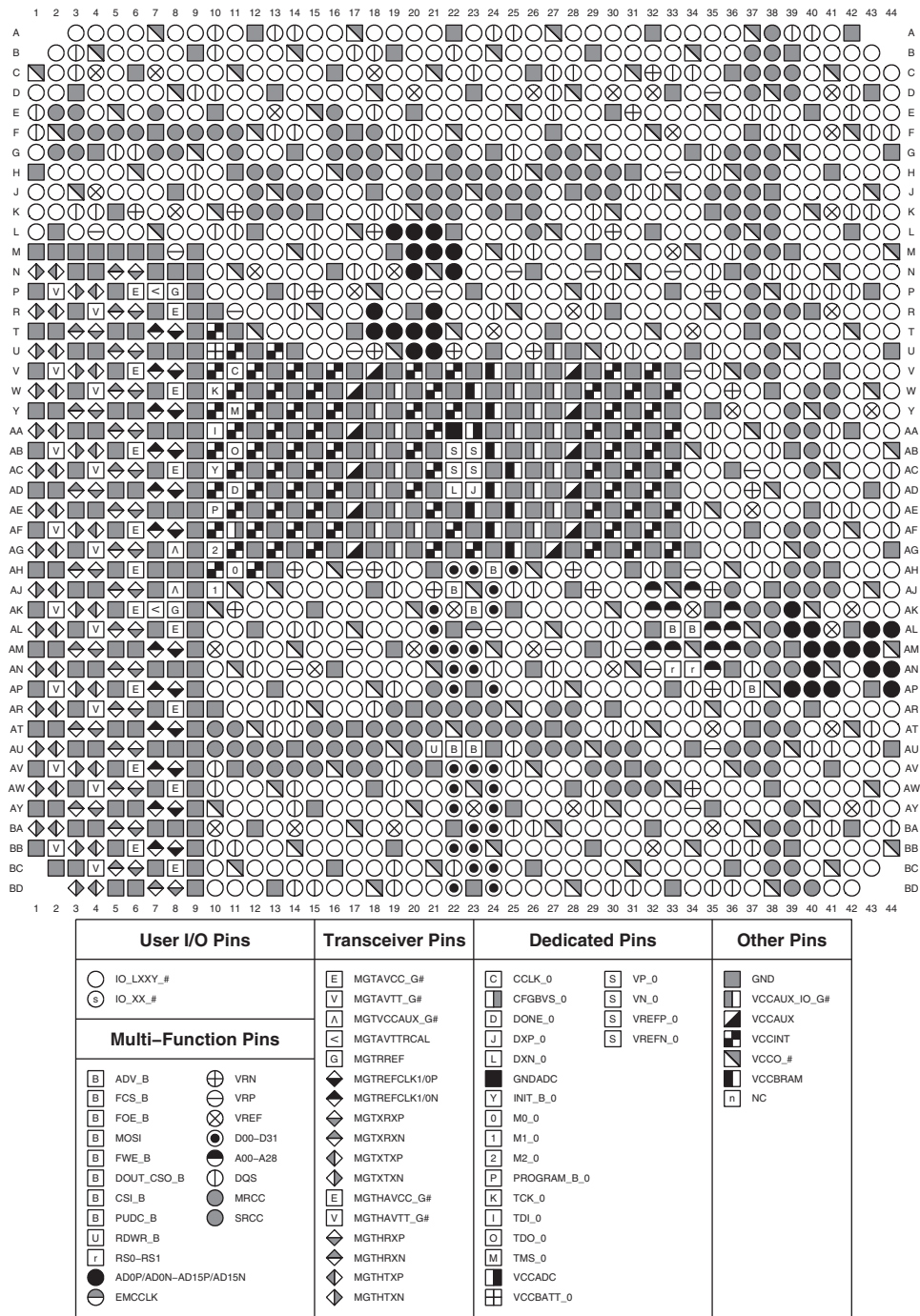

ug475\_c3\_173\_101413

Figure 3-153: FL/FLG1930 Packages—7VX1140T Pinout Diagram

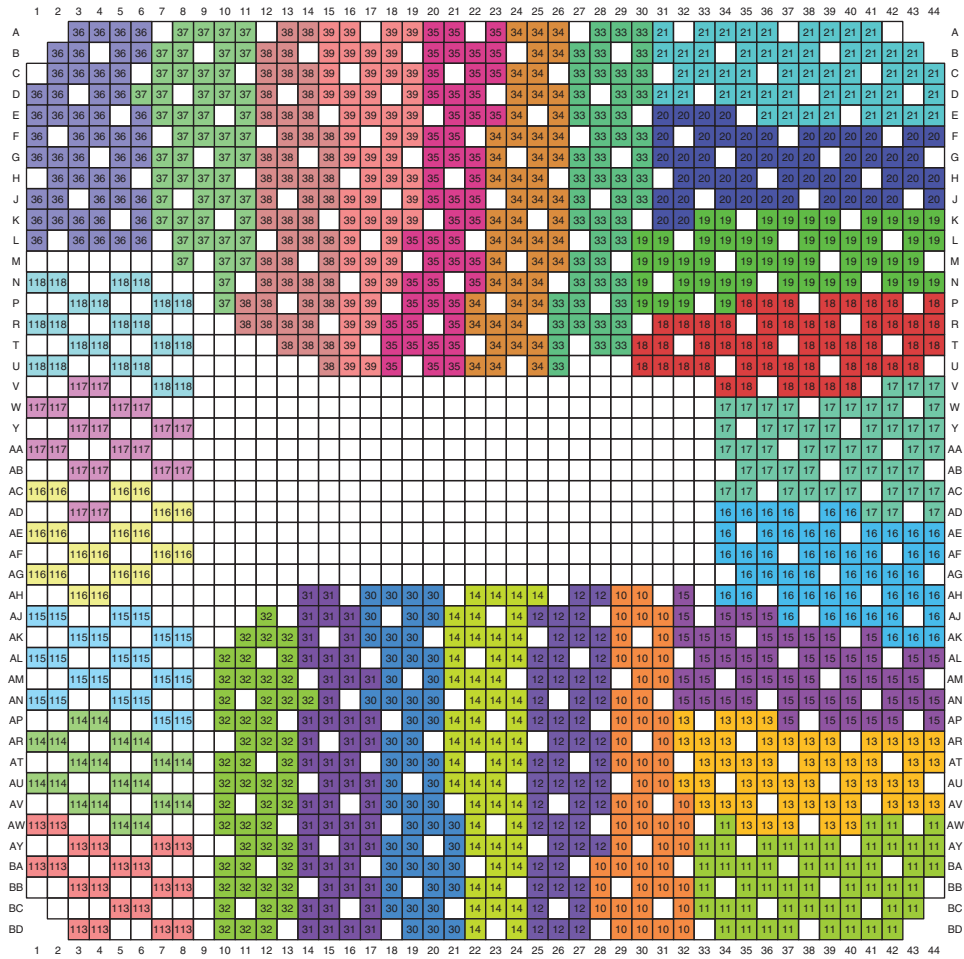

ug475\_c3\_174\_122911

Figure 3-154: FL/FLG1930 Packages—7VX1140T I/O Banks



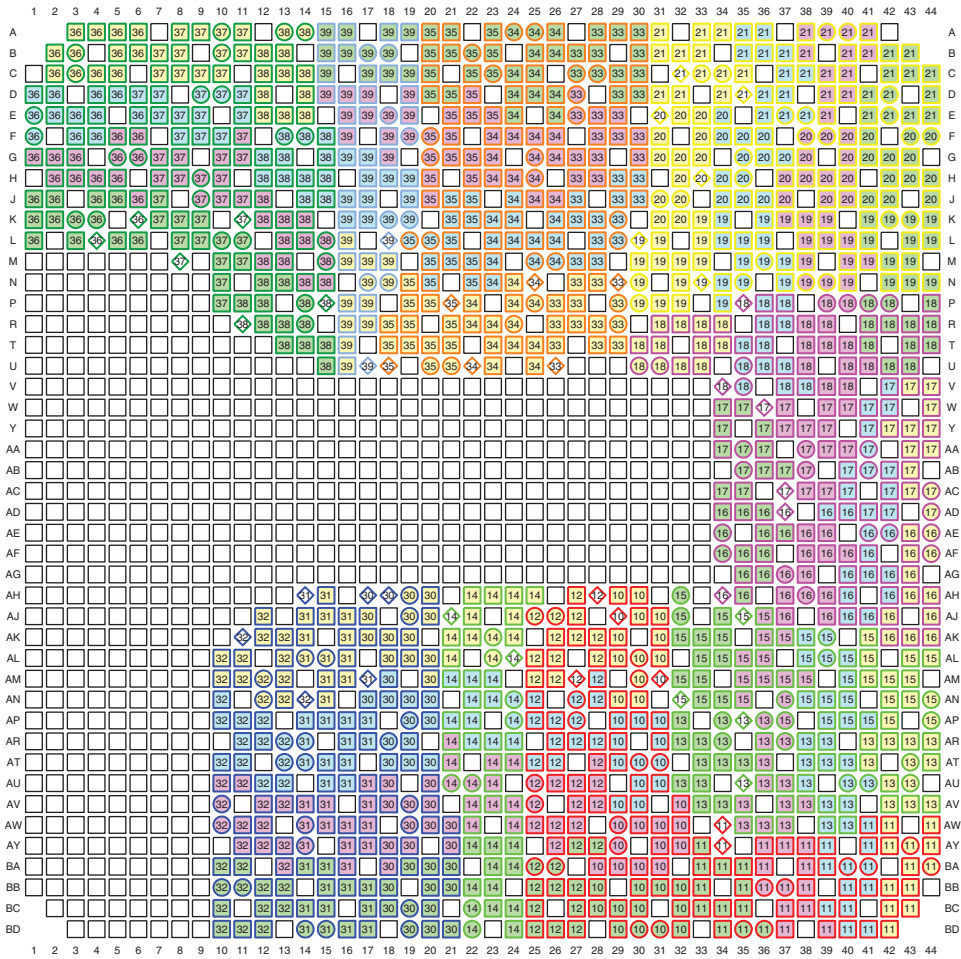

Memory Groupings Pins			
#	HP I/O	#	DQS pin
#	HR I/O	◇	DCI pin
#	HP I/O – VCCAUX Group 0	#	Memory Byte Group 0
#	HP I/O – VCCAUX Group 1	#	Memory Byte Group 1
#	HP I/O – VCCAUX Group 2	#	Memory Byte Group 2
#	HP I/O – VCCAUX Group 3	#	Memory Byte Group 3
#	HP I/O – VCCAUX Group 4	#	Bank Number
#	HP I/O – VCCAUX Group 5		
#	HP I/O – VCCAUX Group 6		
#	HP I/O – VCCAUX Group 7		

ug475\_c3\_175\_122911

Figure 3-155: FL/FLG1930 Packages—7VX1140T Memory Groupings

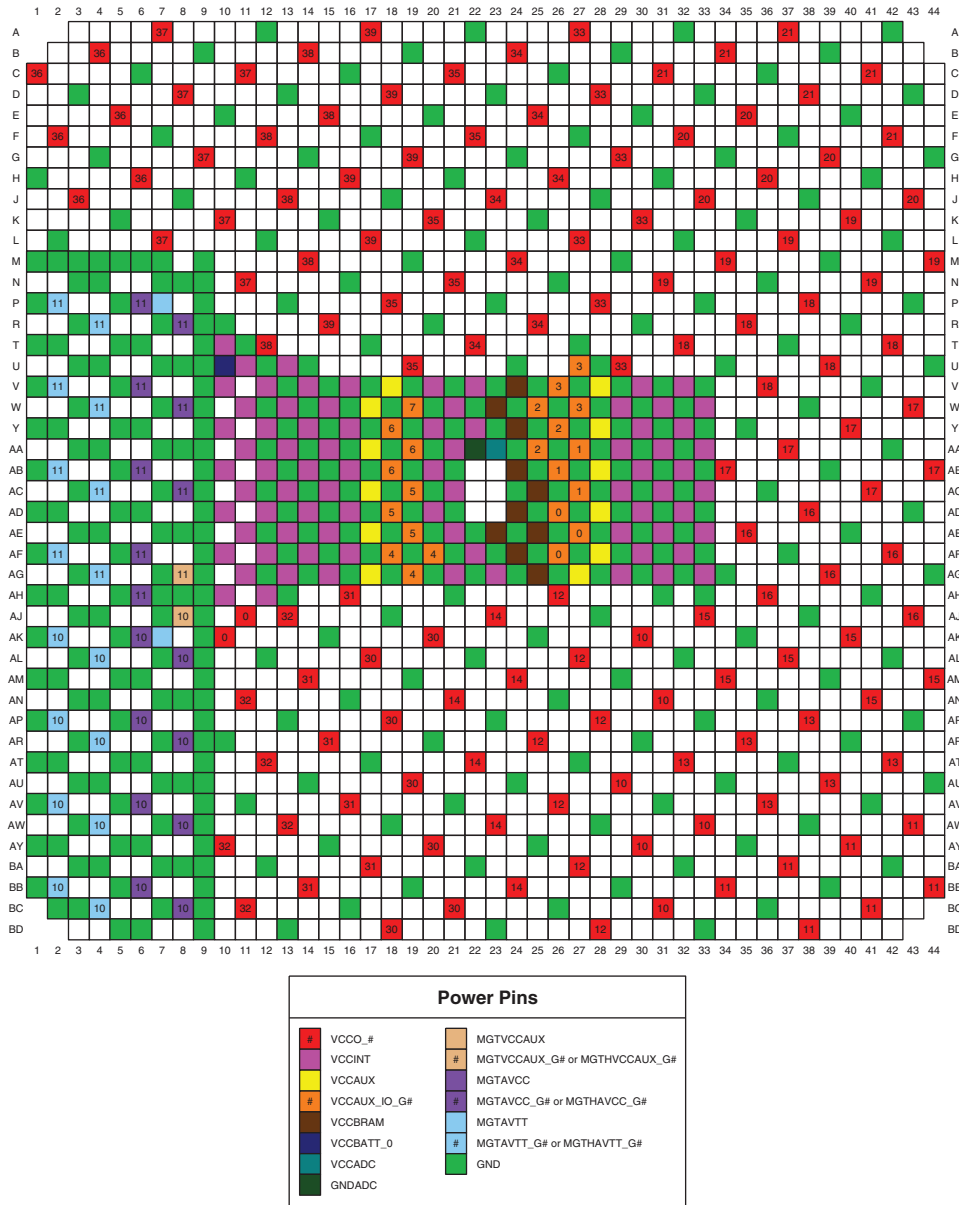

ug475\_c3\_176\_101413

Figure 3-156: FL/FLG1930 Packages—7VX1140T Power and GND Placement

# Mechanical Drawings

---

## Summary

This chapter provides mechanical drawings (package specifications) of the following 7 series FPGA packages.

### Artix-7 FPGAs

- [CS/CSG324 Wire-Bond Chip-Scale BGA \(Artix-7 FPGAs\) \(0.8 mm Pitch\), page 205](#)
- [FTG256 Wire-Bond Fine-Pitch Thin BGA \(Artix-7 FPGAs\) \(1.0 mm Pitch\), page 206](#)
- [SBG484 Flip-Chip Lidless BGA \(Artix-7 FPGAs\) \(0.8 mm Pitch\), page 207](#)
- [FB/FBG484 Flip-Chip Lidless BGA \(Artix-7 FPGAs\) \(1.0 mm Pitch\), page 208](#)
  - [XC7A200T FB/FBG484 Die Dimensions, page 209](#)
- [FB/FBG676 Flip-Chip Lidless BGA \(Artix-7 FPGAs\) \(1.0 mm Pitch\), page 210](#)
  - [XC7A200T FB/FBG676 Die Dimensions, page 211](#)
- [FG/FGG484 Wire-Bond Fine-Pitch BGA \(Artix-7 FPGAs\) \(1.0 mm Pitch\), page 212](#)
- [FG/FGG676 Wire-Bond Fine-Pitch BGA \(Artix-7 FPGAs\) \(1.0 mm Pitch\), page 213](#)
- [FF/FFG1156 Flip-Chip BGA \(Artix-7 FPGAs\) \(1.0 mm Pitch\), page 214](#)
- [RB484 Ruggedized Flip-Chip BGA \(Artix-7 FPGAs\) \(1.0 mm Pitch\), page 215](#)
- [RS484 Ruggedized Flip-Chip BGA \(Artix-7 FPGAs\) \(1.0 mm Pitch\), page 216](#)
- [RB676 Ruggedized Flip-Chip BGA \(Artix-7 FPGAs\) \(1.0 mm Pitch\), page 217](#)

### Kintex-7 FPGAs

- [FB/FBG484 Flip-Chip Lidless BGA \(Kintex-7 FPGAs\) \(1.0 mm Pitch\), page 218](#)
  - [XC7K70T FB/FBG484 Die Dimensions with Capacitor Locations, page 219](#)
  - [XC7K160T FB/FBG484 Die Dimensions with Capacitor Locations, page 220](#)
- [FB/FBG676 Flip-Chip Lidless BGA \(Kintex-7 FPGAs\) \(1.0 mm Pitch\), page 221](#)
  - [XC7K70T FB/FBG676 Die Dimensions with Capacitor Locations, page 222](#)
  - [XC7K160T FB/FBG676 Die Dimensions with Capacitor Locations, page 223](#)
  - [XC7K325T FB/FBG676 Die Dimensions with Capacitor Locations, page 224](#)
  - [XC7K410T FB/FBG676 Die Dimensions with Capacitor Locations, page 225](#)
- [FB/FBG900 Flip-Chip Lidless BGA \(Kintex-7 FPGAs\) \(1.0 mm Pitch\), page 226](#)
  - [XC7K325T FB/FBG900 Die Dimensions with Capacitor Locations, page 227](#)
  - [XC7K410T FB/FBG900 Die Dimensions with Capacitor Locations, page 228](#)

- FF/FFG676 Flip-Chip BGA (Kintex-7 FPGAs) (1.0 mm Pitch), page 229
- FF/FFG900 and FF/FFG901 Flip-Chip BGA (Kintex-7 FPGAs) (1.0 mm Pitch), page 230
- FF/FFG1156 Flip-Chip BGA (Kintex-7 FPGAs) (1.0 mm Pitch), page 231
- RF676 Flip-Chip BGA (Kintex-7 FPGAs) (1.0 mm Pitch), page 232
- RF900 Flip-Chip BGA (Kintex-7 FPGAs) (1.0 mm Pitch), page 233

## Virtex-7 FPGAs

- FF/FFG1157 and FF/FFG1158 Flip-Chip BGA (Virtex-7 FPGAs) (1.0 mm Pitch), page 234
- FF/FFG1761 Flip-Chip BGA (Virtex-7 FPGAs) (1.0 mm Pitch), page 235
- FH/FHG1761 Flip-Chip BGA (Virtex-7 T FPGAs) (1.0 mm Pitch), page 236
- FF/FFG1926, FF/FFG1927, FF/FFG1928, and FF/FFG1930 Flip-Chip BGA (Virtex-7 XT FPGAs) (1.0 mm Pitch), page 237
- FL/FLG1925, FL/FLG1926, FL/FLG1928, and FL/FLG1930 Flip-Chip BGA (Virtex-7 FPGAs) (1.0 mm Pitch), page 238
- RF1157 Flip-Chip BGA (Virtex-7 FPGAs) (1.0 mm Pitch), page 239
- RF1761 Flip-Chip BGA (Virtex-7 FPGAs) (1.0 mm Pitch), page 240
- RF1930 Flip-Chip BGA (Virtex-7 FPGAs) (1.0 mm Pitch), page 241

# CS/CSG324 Wire-Bond Chip-Scale BGA (Artix-7 FPGAs) (0.8 mm Pitch)

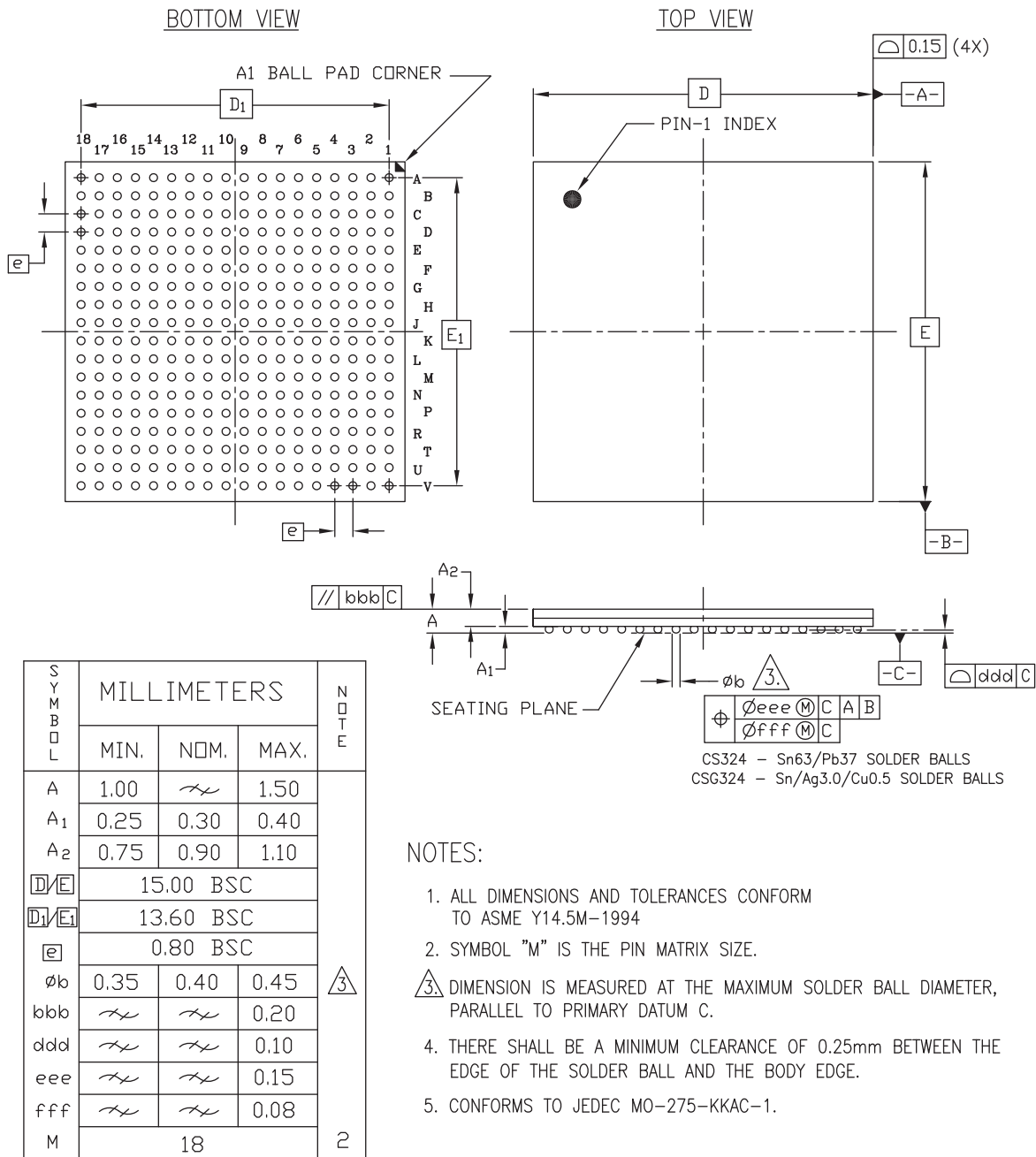

ug475\_c4\_100\_070912

Figure 4-1: CS/CSG324 Wire-Bond Chip-Scale BGA Package Specifications for Artix-7 FPGAs



# SBG484 Flip-Chip Lidless BGA (Artix-7 FPGAs) (0.8 mm Pitch)

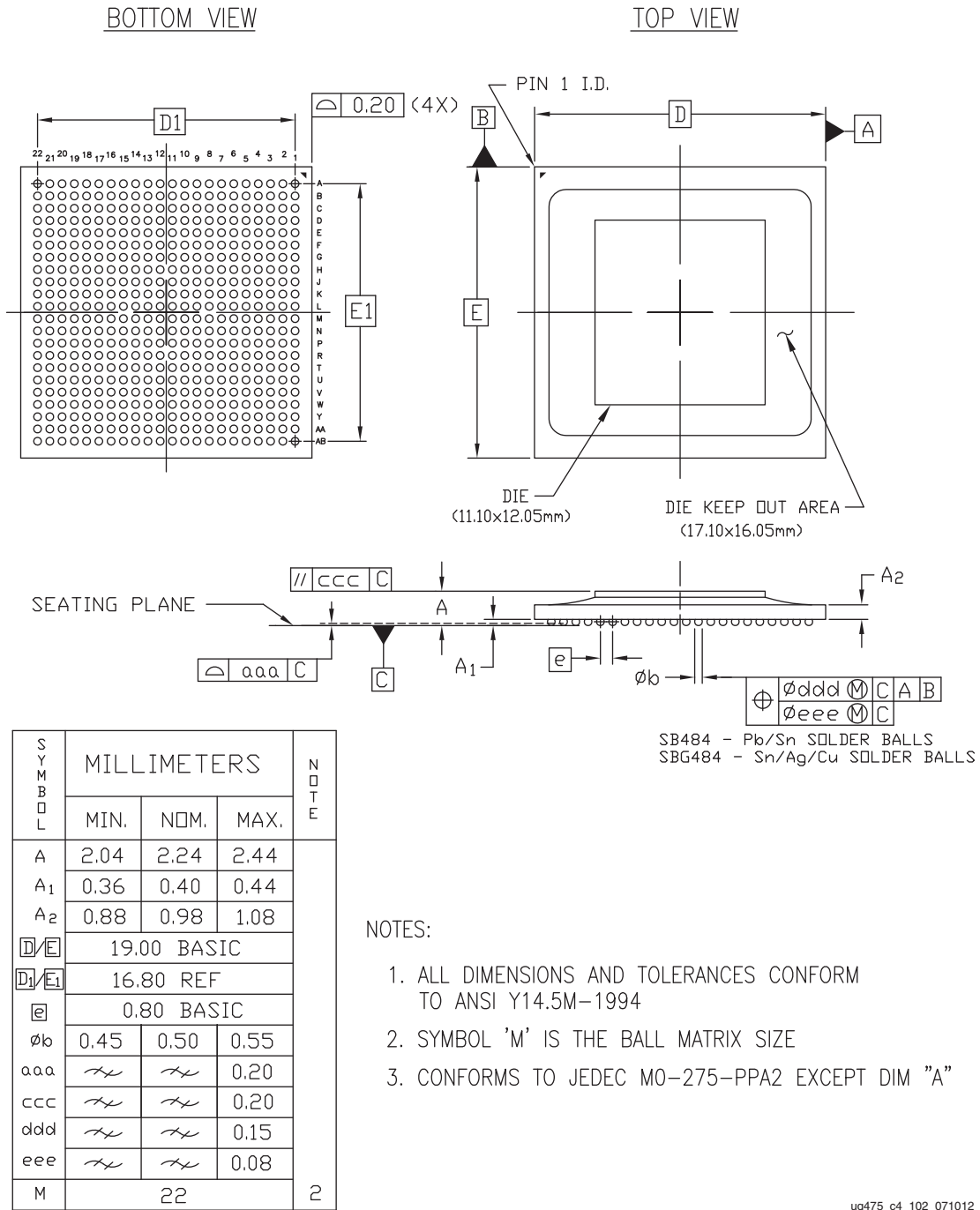

ug475\_c4\_102\_071012

Figure 4-3: SBG484 Flip-Chip Lidless BGA Package Specifications for Artix-7 FPGAs

## FB/FBG484 Flip-Chip Lidless BGA (Artix-7 FPGAs) (1.0 mm Pitch)

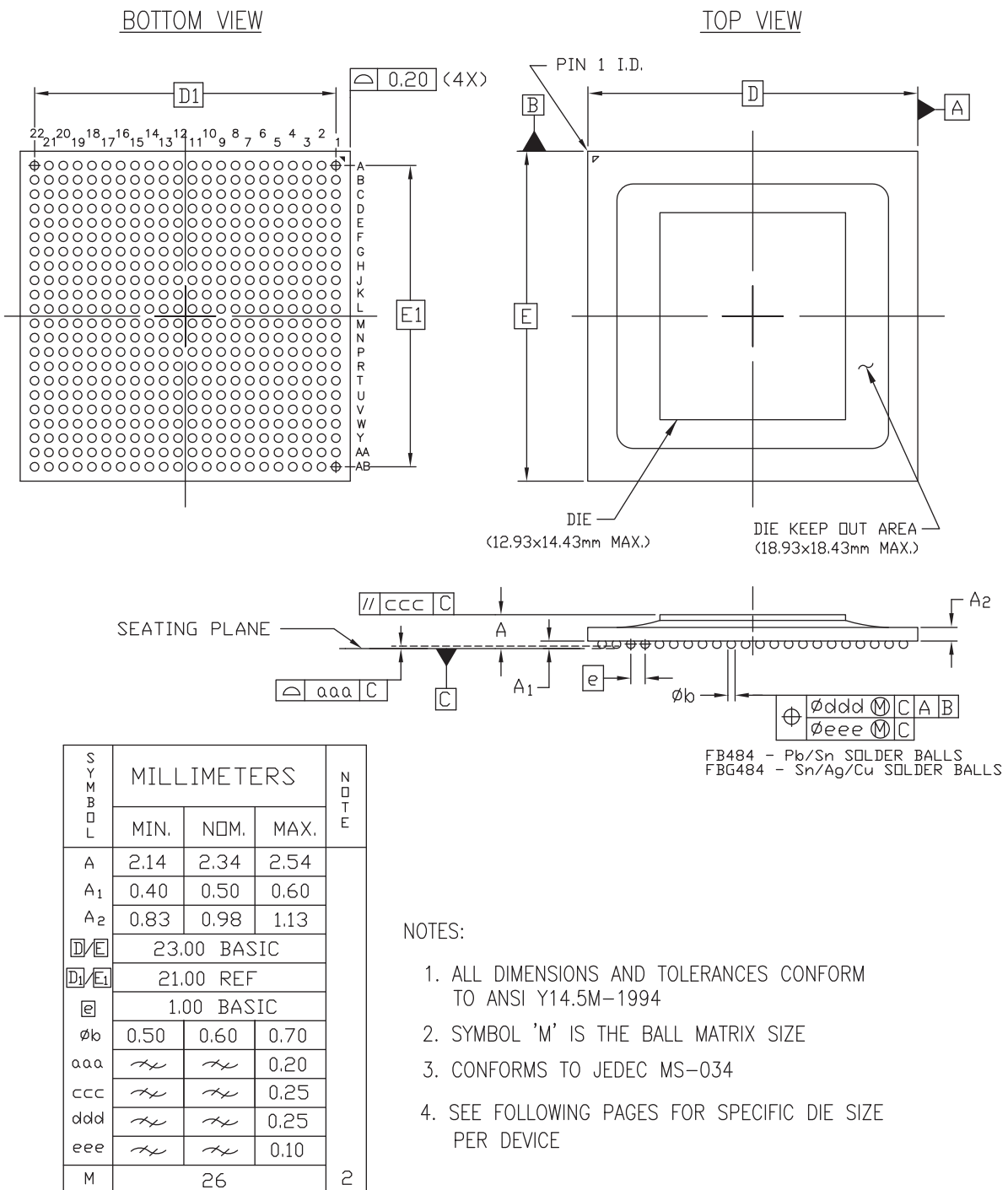

ug475\_c4\_103\_092613

Figure 4-4: FB/FBG484 Flip-Chip Lidless BGA Package Specifications for Artix-7 FPGAs



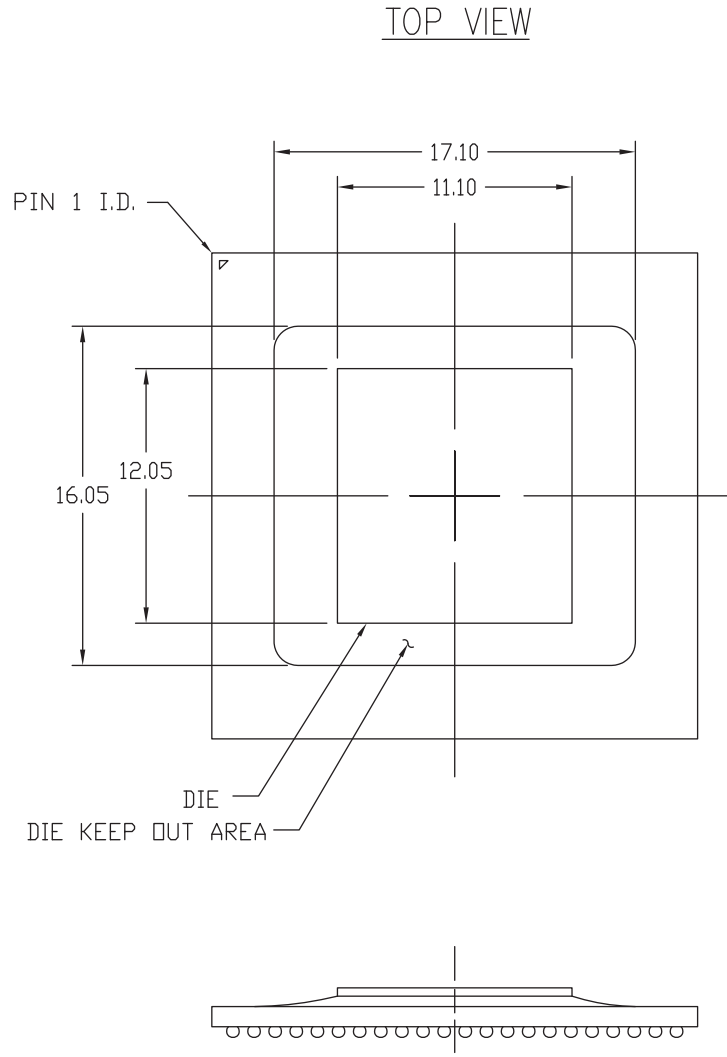

ug475\_c4\_104\_092613

Figure 4-5: **XC7A200T FB/FBG484 Die Dimensions**

## FB/FBG676 Flip-Chip Lidless BGA (Artix-7 FPGAs) (1.0 mm Pitch)

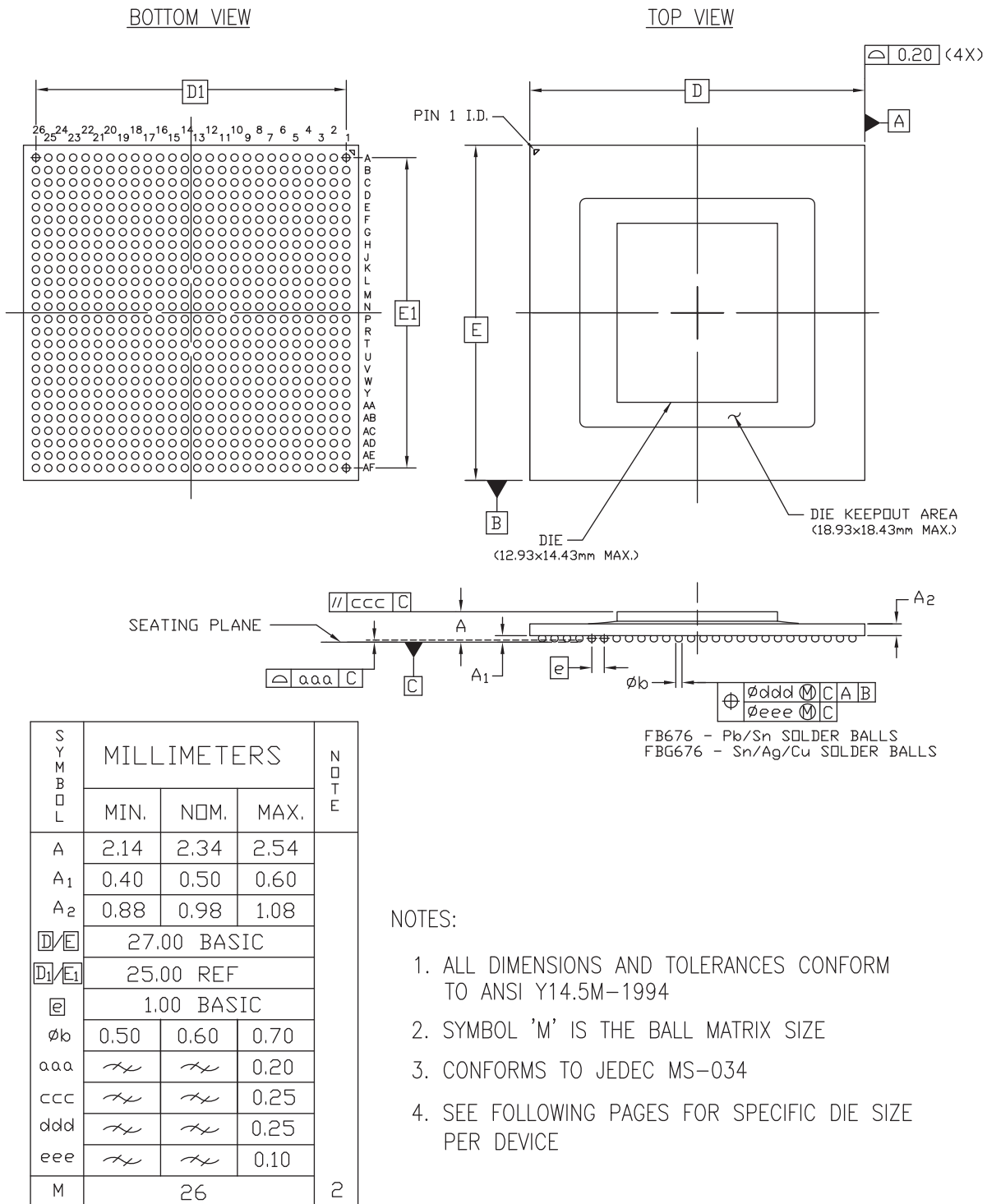

ug475\_c4\_106\_070912

Figure 4-6: FB/FBG676 Flip-Chip Lidless BGA Package Specifications for Artix-7 FPGAs

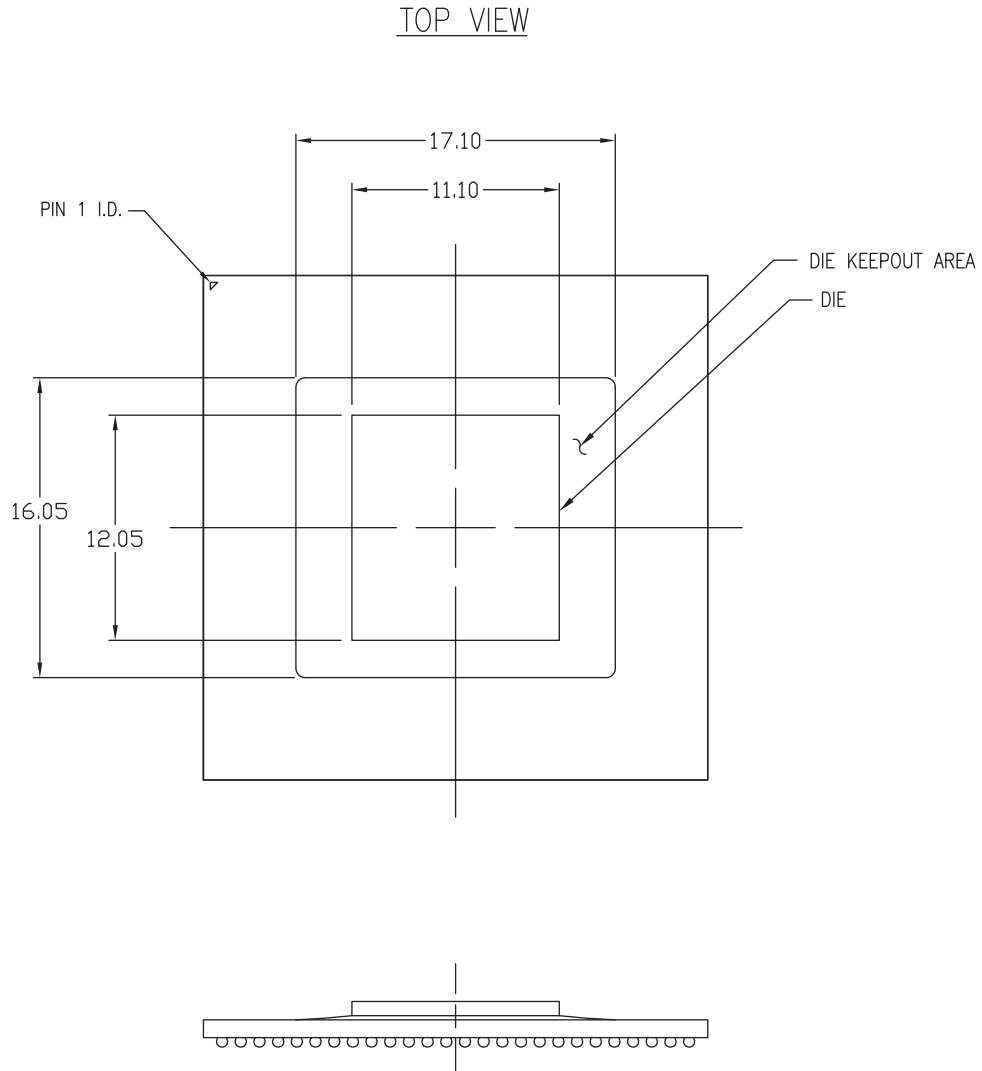

ug475\_c4\_107\_070912

Figure 4-7: XC7A200T FB/FBG676 Die Dimensions

## FG/FGG484 Wire-Bond Fine-Pitch BGA (Artix-7 FPGAs) (1.0 mm Pitch)

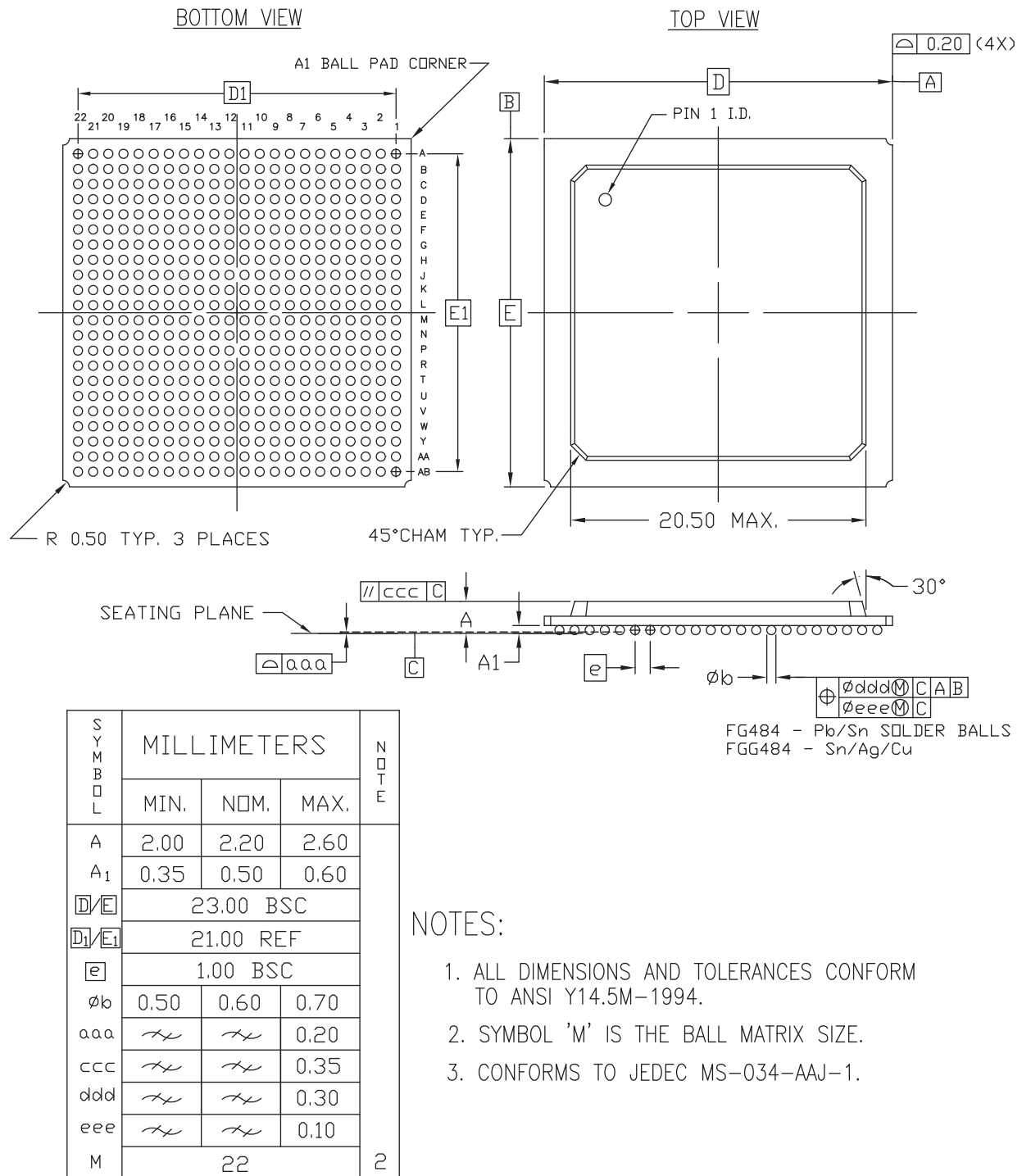

ug475\_c4\_109\_071212

Figure 4-8: FG/FGG484 Wire-bond Fine-Pitch BGA Package Specification for Artix-7 FPGAs

## FG/FGG676 Wire-Bond Fine-Pitch BGA (Artix-7 FPGAs) (1.0 mm Pitch)

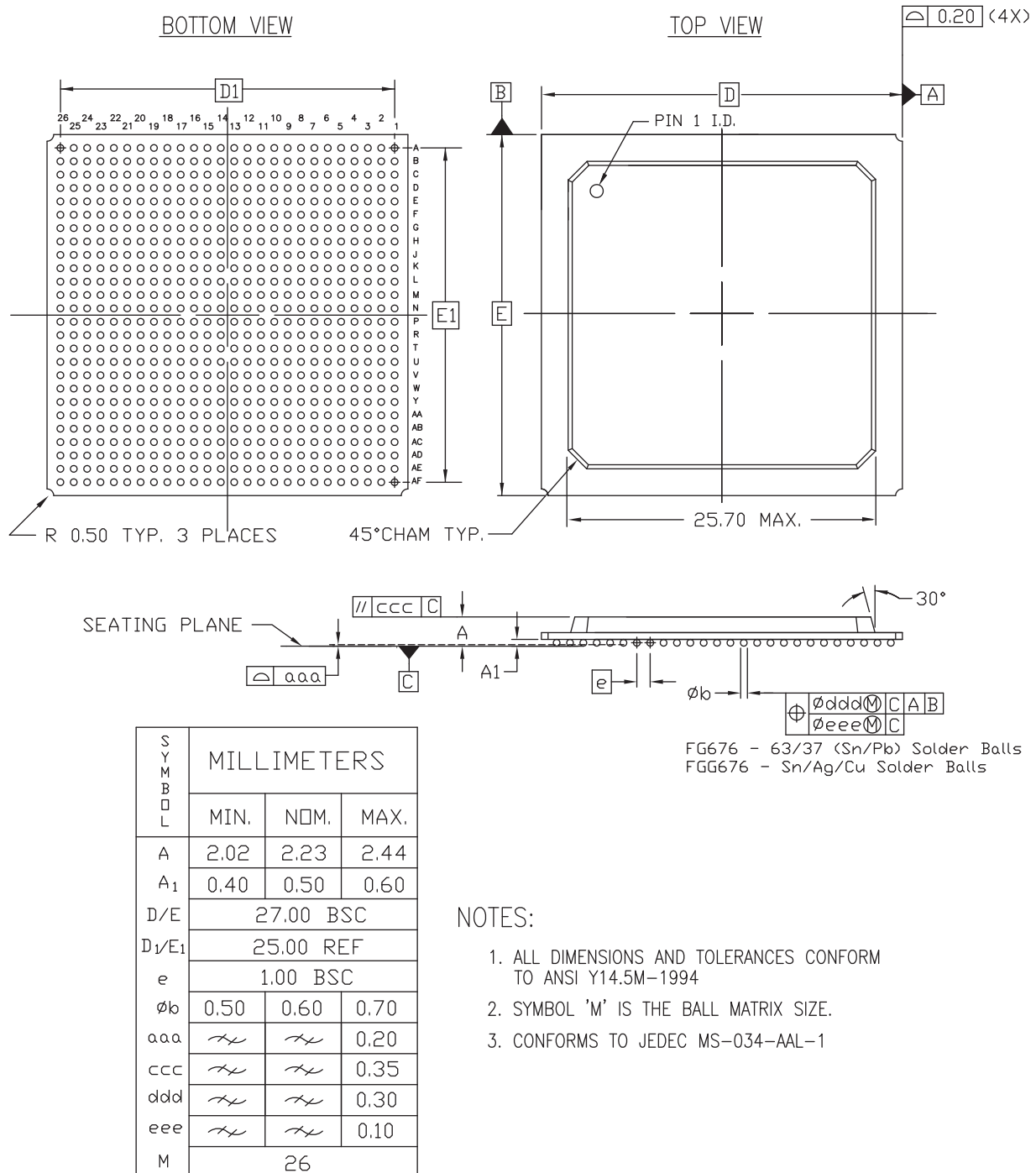

ug475\_c4\_110\_070912

Figure 4-9: FG/FGG676 Wire-bond Fine-Pitch BGA Package Specification for Artix-7 FPGAs

## FF/FFG1156 Flip-Chip BGA (Artix-7 FPGAs) (1.0 mm Pitch)

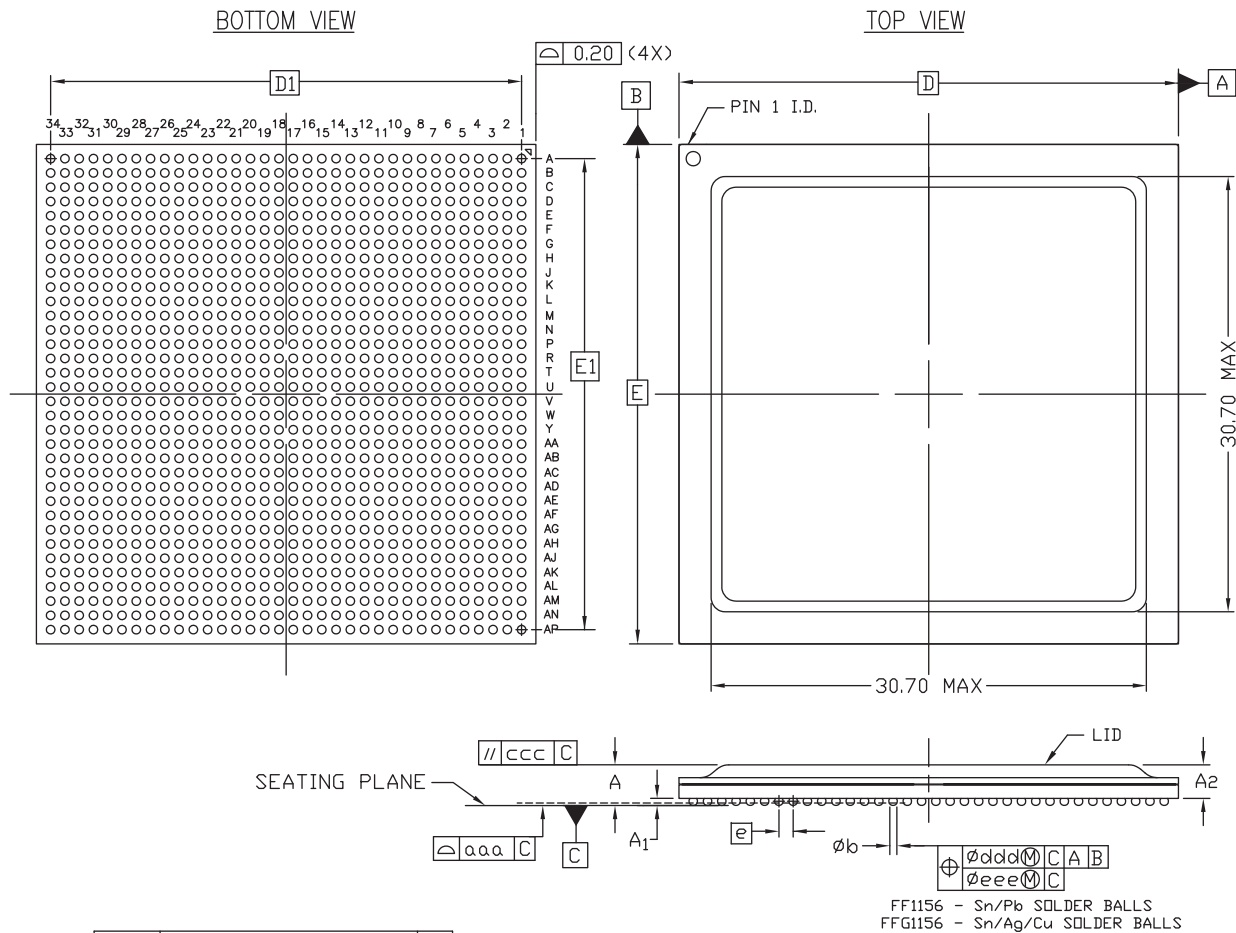

SYMBOL	MILLIMETERS			NOTE	
	MIN.	NOM.	MAX.		
A	2.70	2.90	3.10	4	
A <sub>1</sub>	0.40	0.50	0.60		
A <sub>2</sub>	2.30	2.40	2.50		
D <sub>1</sub> /E	35.00 BASIC				
D <sub>1</sub> /E <sub>1</sub>	33.00 REF				
e	1.00 BASIC				
φb	0.50	0.60	0.70		
aaa	<i>HL</i>	<i>HL</i>	0.20		
ccc	<i>HL</i>	<i>HL</i>	0.35		
ddd	<i>HL</i>	<i>HL</i>	0.30		
eee	<i>HL</i>	<i>HL</i>	0.10		
M	34				2

FF1156 - Sn/Pb SOLDER BALLS  
FFG1156 - Sn/Ag/Cu SOLDER BALLS

**NOTES:**

1. ALL DIMENSIONS AND TOLERANCES CONFORM TO ANSI Y14.5M-1994
2. SYMBOL 'M' IS THE BALL MATRIX SIZE
3. CONFORMS TO JEDEC MS-034-AAR-1
4. ACTUAL SOLDER BALL COUNT = 1156
5. THIS PACKAGE IS USED FOR ARTIX<sup>®</sup>-7 FPGAs  
REFER TO PK384 FOR THE MECHANICAL DRAWING OF FF1156 PACKAGE USED FOR VIRTEX<sup>®</sup>-5 FPGAs  
AND PK401 FOR VIRTEX<sup>®</sup>-6 FPGAs

ug475\_c4\_111\_050913

**Figure 4-10: FF/FFG1156 Flip-Chip BGA Package Specification for Artix-7 FPGAs**

# RB484 Ruggedized Flip-Chip BGA (Artix-7 FPGAs) (1.0 mm Pitch)

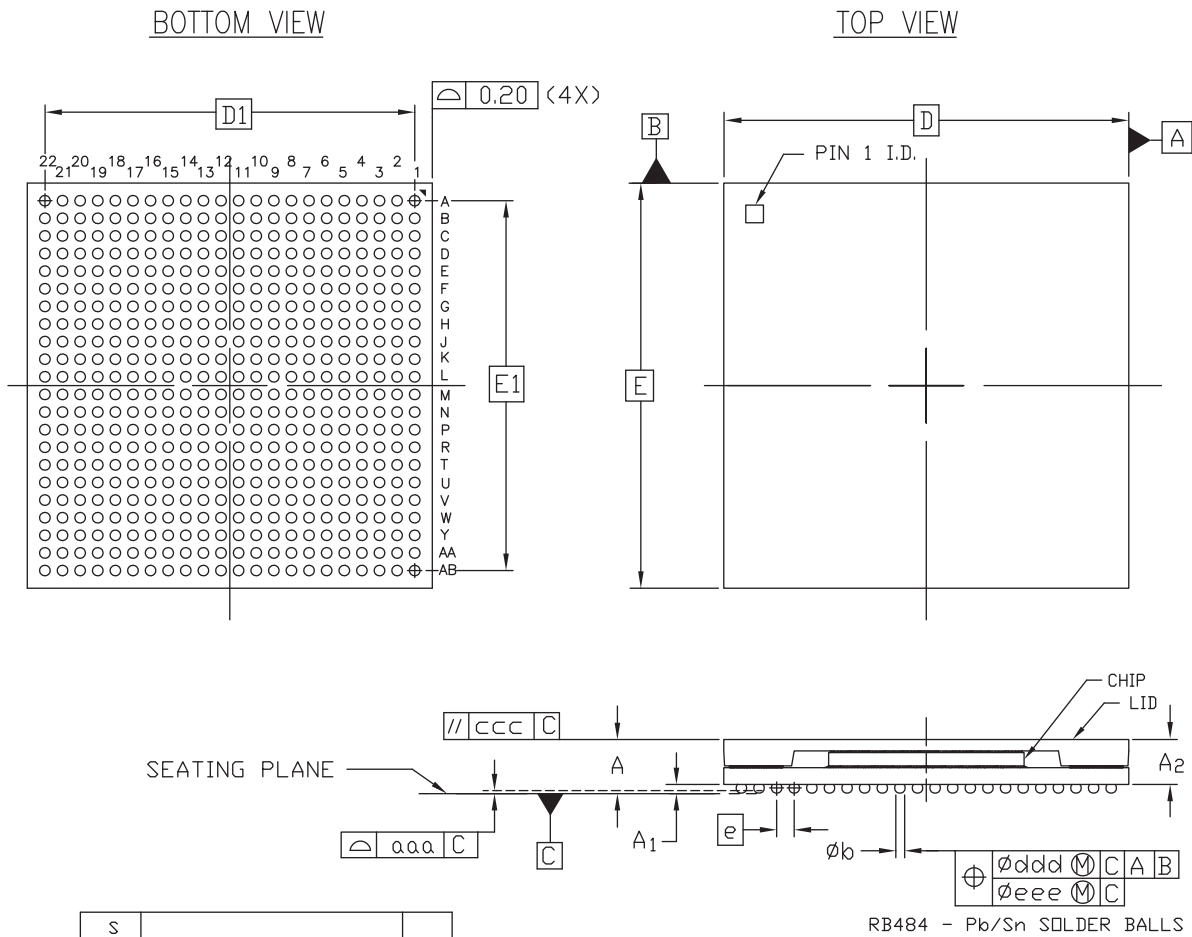

RB484 - Pb/Sn SOLDER BALLS

SYMBOL	MILLIMETERS			NOTE
	MIN.	NOM.	MAX.	
A	2.75	3.05	3.35	2
A <sub>1</sub>	0.40	0.50	0.60	
A <sub>2</sub>	2.35	2.55	2.75	
D/E	23.00 BASIC			
D <sub>1</sub> /E <sub>1</sub>	21.00 REF			
e	1.00 BASIC			
$\phi b$	0.50	0.60	0.70	
aaa	<i>↗</i>	<i>↗</i>	0.20	
ccc	<i>↗</i>	<i>↗</i>	0.25	
ddd	<i>↗</i>	<i>↗</i>	0.25	
eee	<i>↗</i>	<i>↗</i>	0.10	
M	26			

NOTES:

1. ALL DIMENSIONS AND TOLERANCES CONFORM TO ANSI Y14.5M-1994
2. SYMBOL 'M' IS THE BALL MATRIX SIZE
3. CONFORMS TO JEDEC MS-034

ug475\_c4\_112\_092613

Figure 4-11: RB484 Ruggedized Flip-Chip BGA Package Specifications for Artix-7 FPGAs

## RS484 Ruggedized Flip-Chip BGA (Artix-7 FPGAs) (1.0 mm Pitch)

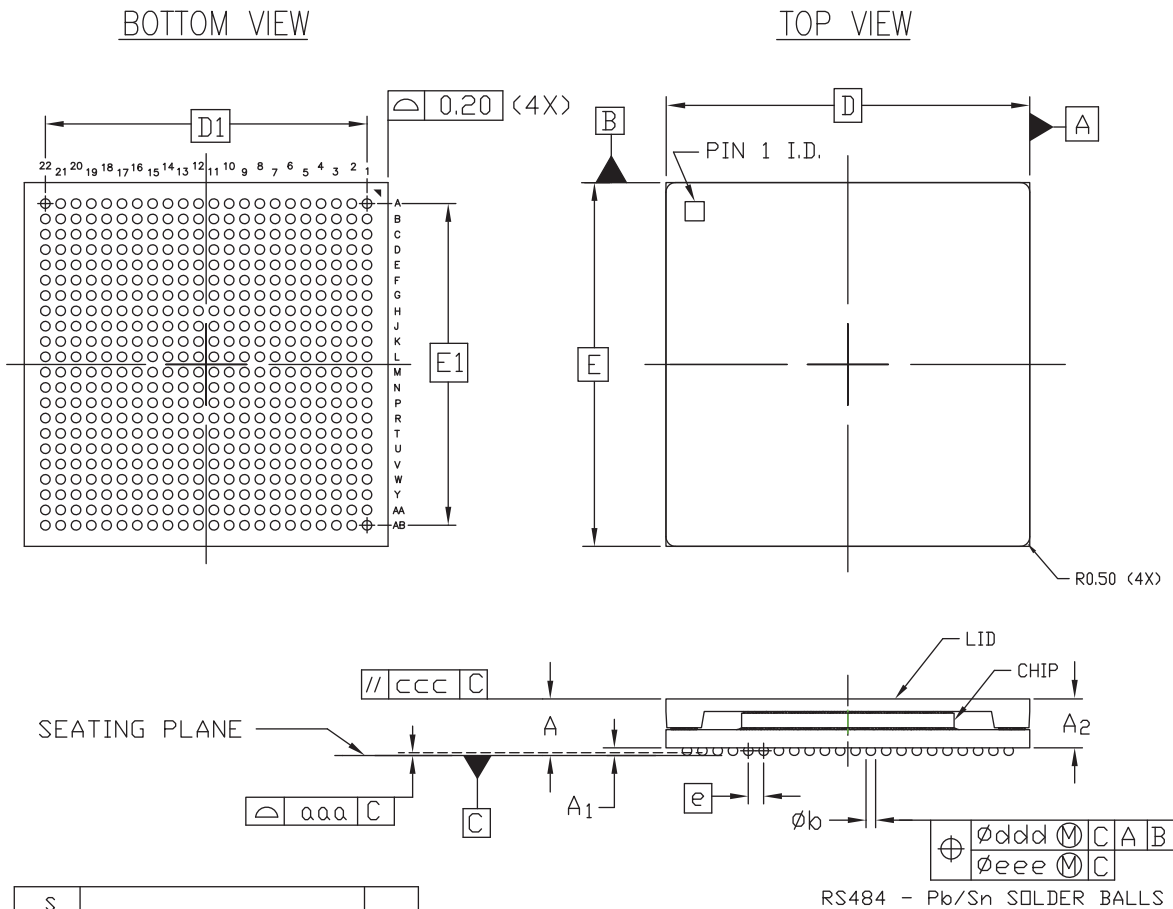

NOTES:

1. ALL DIMENSIONS AND TOLERANCES CONFORM TO ANSI Y14.5M-1994
2. SYMBOL 'M' IS THE BALL MATRIX SIZE
3. CONFORMS TO JEDEC MO-275-PPA2 EXCEPT DIM "A"

ug475\_c4\_113\_092613

Figure 4-12: RS484 Ruggedized Flip-Chip BGA Package Specifications for Artix-7 FPGAs



# RB676 Ruggedized Flip-Chip BGA (Artix-7 FPGAs) (1.0 mm Pitch)

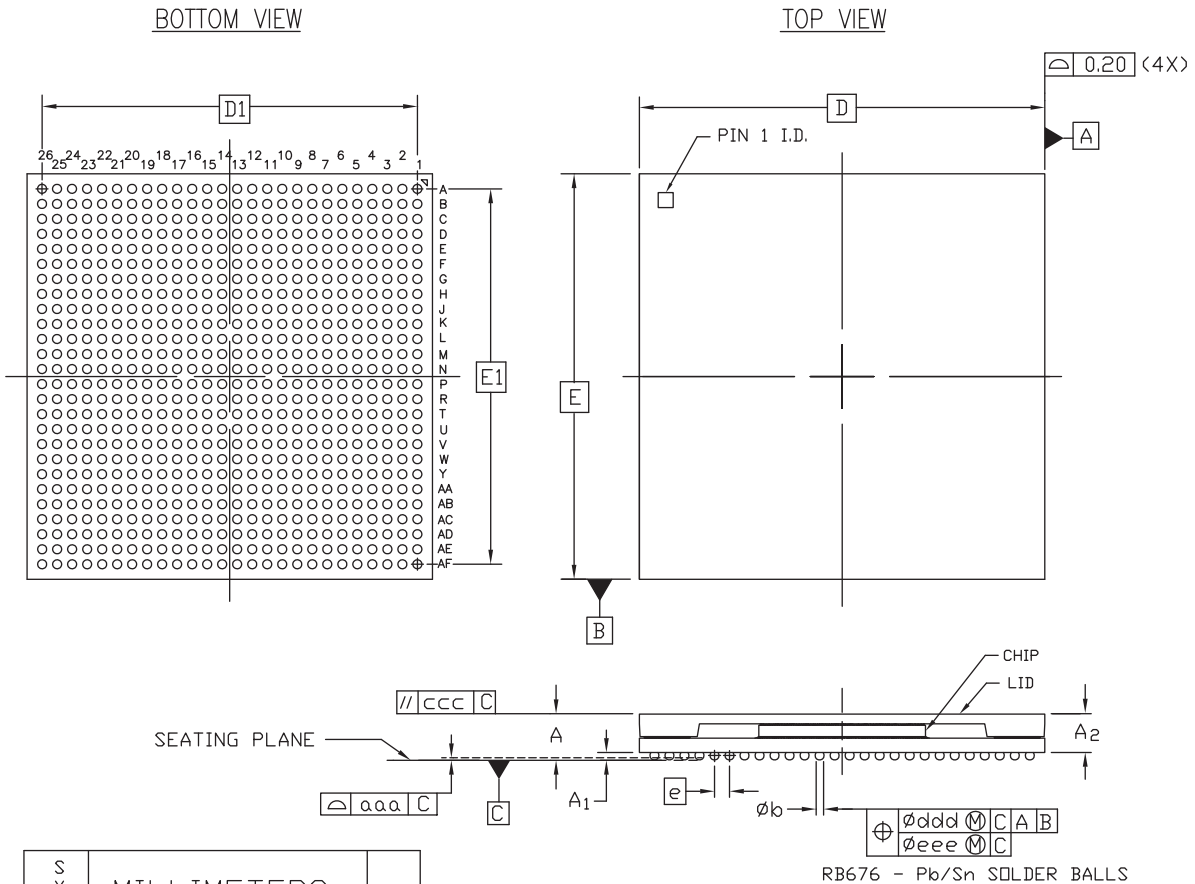

NOTES:

1. ALL DIMENSIONS AND TOLERANCES CONFORM TO ANSI Y14.5M-1994
2. SYMBOL 'M' IS THE BALL MATRIX SIZE
3. CONFORMS TO JEDEC MS-034-AAL-1

ug475\_c4\_114\_092613

Figure 4-13: RB676 Ruggedized Flip-Chip BGA Package Specifications for Artix-7 FPGAs

## FB/FBG484 Flip-Chip Lidless BGA (Kintex-7 FPGAs) (1.0 mm Pitch)

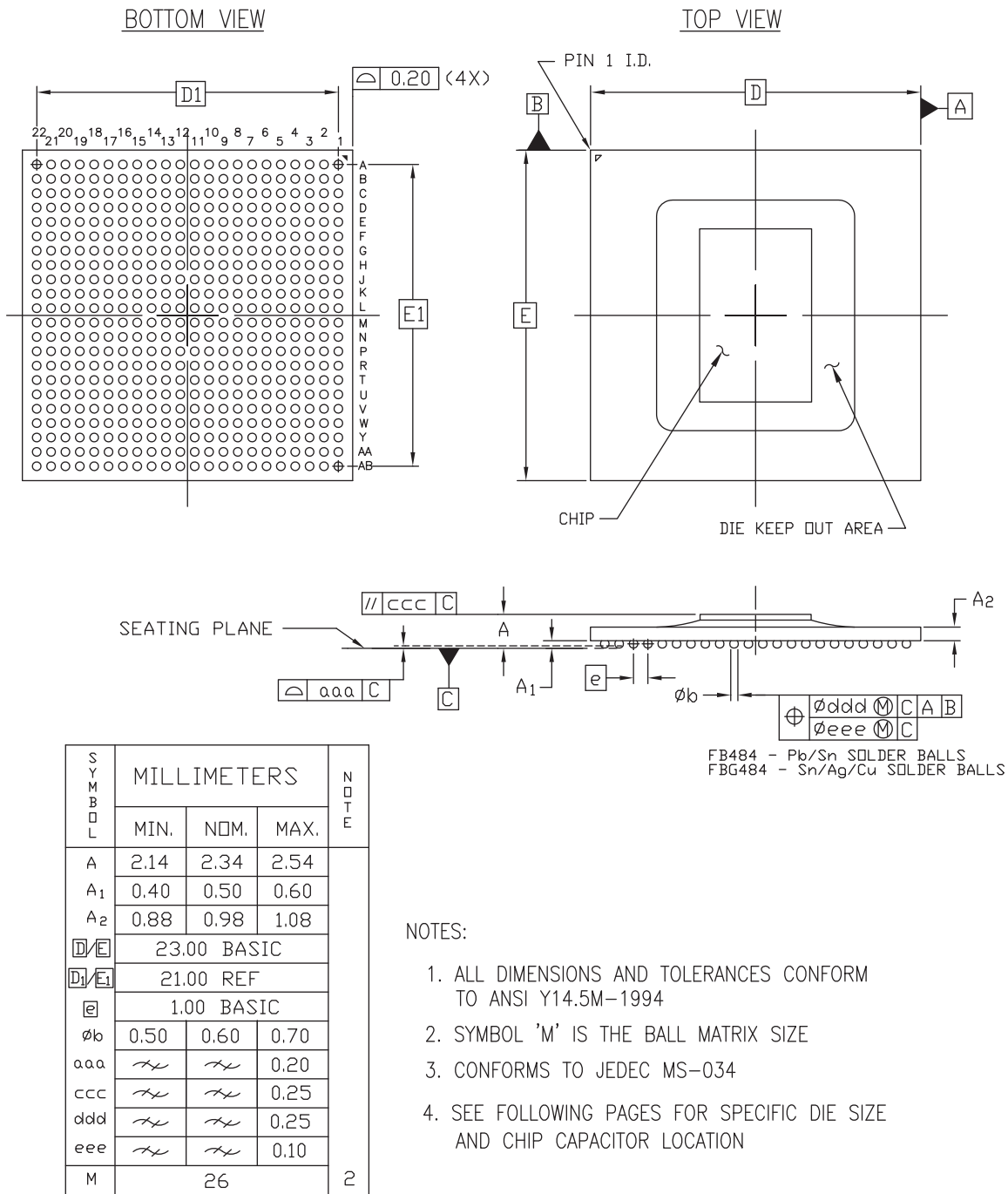

ug475\_c4\_01\_020413

Figure 4-14: FB/FBG484 Flip-Chip Lidless BGA Package Specifications for Kintex-7 FPGAs



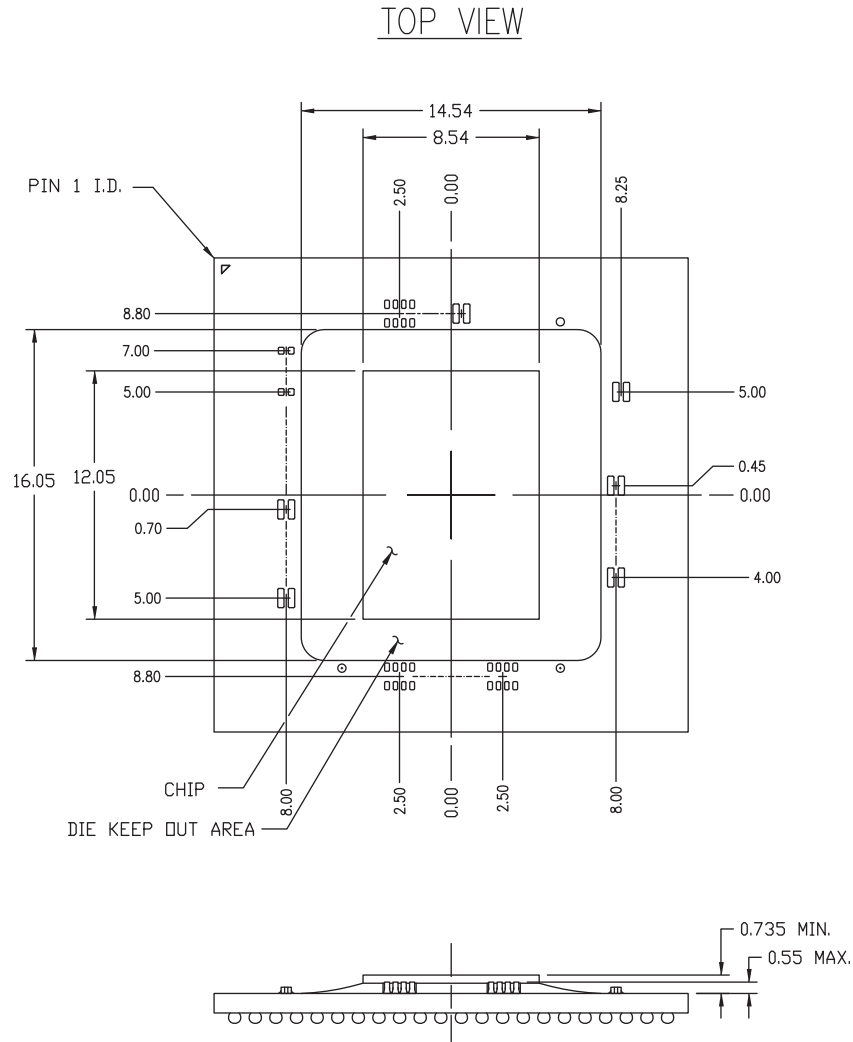

ug475\_c4\_21\_013113

Figure 4-16: XC7K160T FB/FBG484 Die Dimensions with Capacitor Locations

# FB/FBG676 Flip-Chip Lidless BGA (Kintex-7 FPGAs) (1.0 mm Pitch)

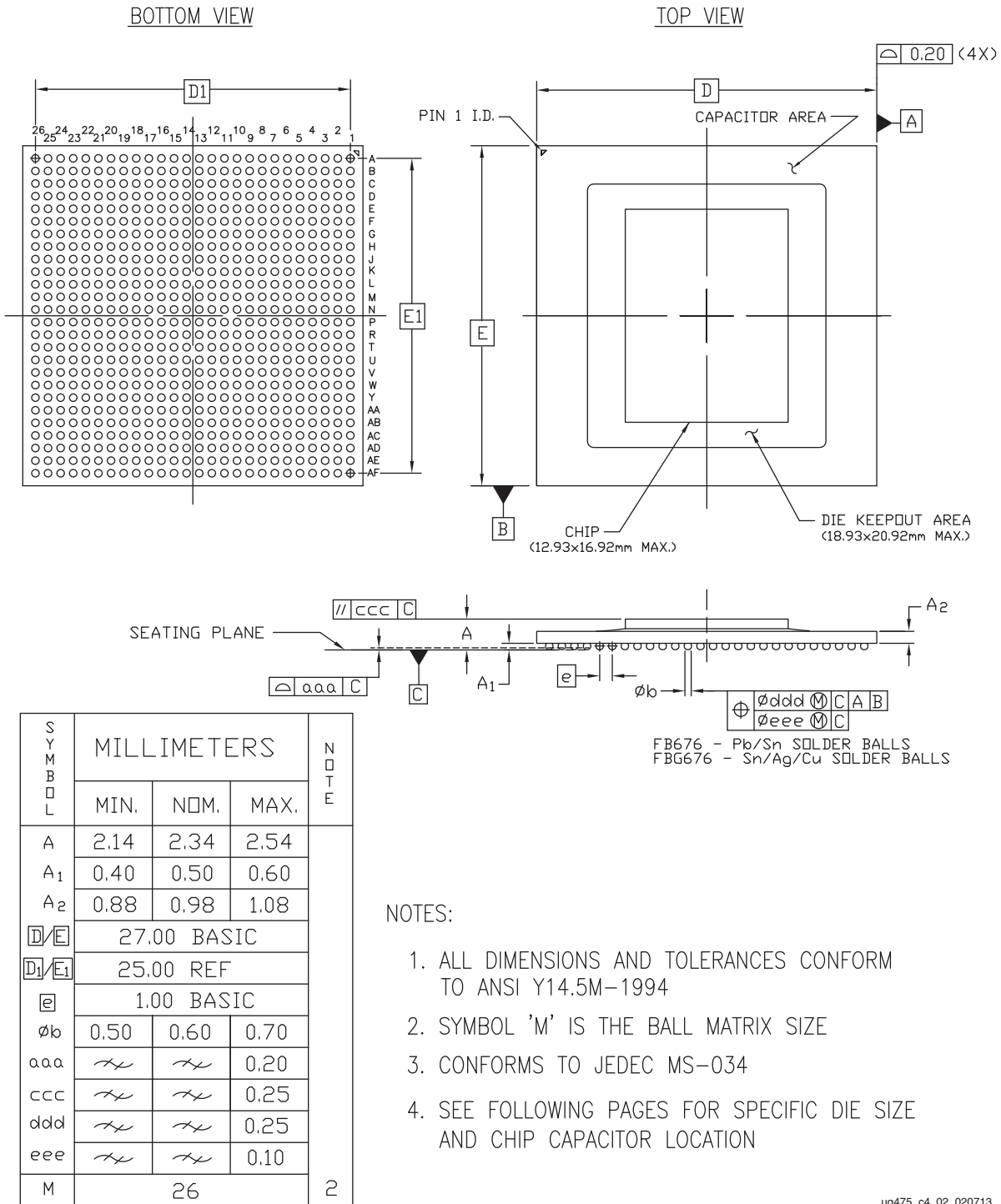

Figure 4-17: FB/FBG676 Flip-Chip Lidless BGA Package Specifications for Kintex-7 FPGAs

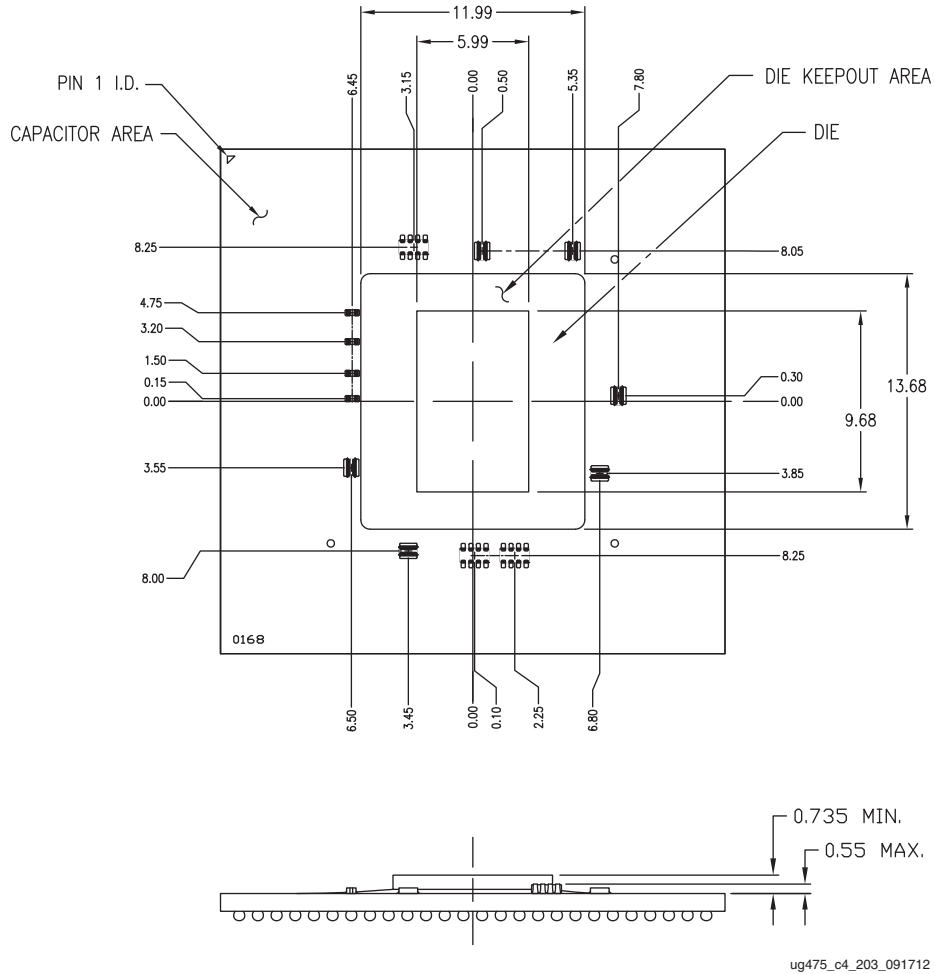
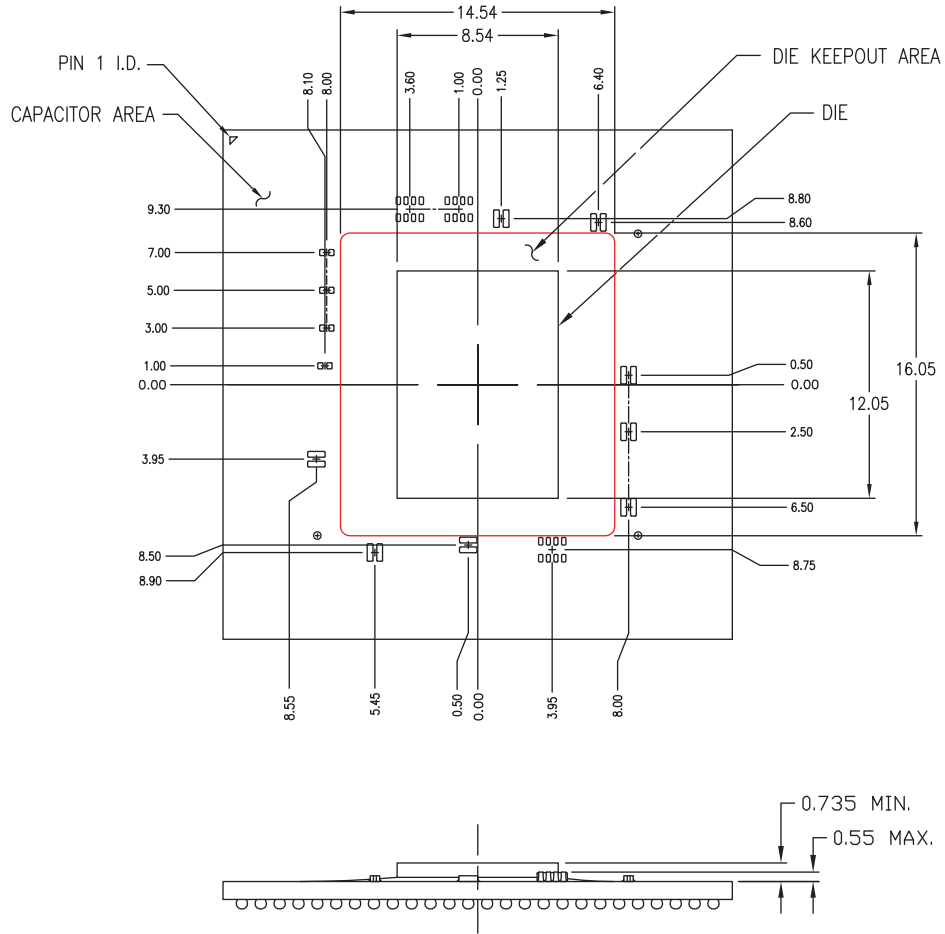

Figure 4-18: XC7K70T FB/FBG676 Die Dimensions with Capacitor Locations



ug475\_c4\_204\_091712

Figure 4-19: XC7K160T FB/FBG676 Die Dimensions with Capacitor Locations

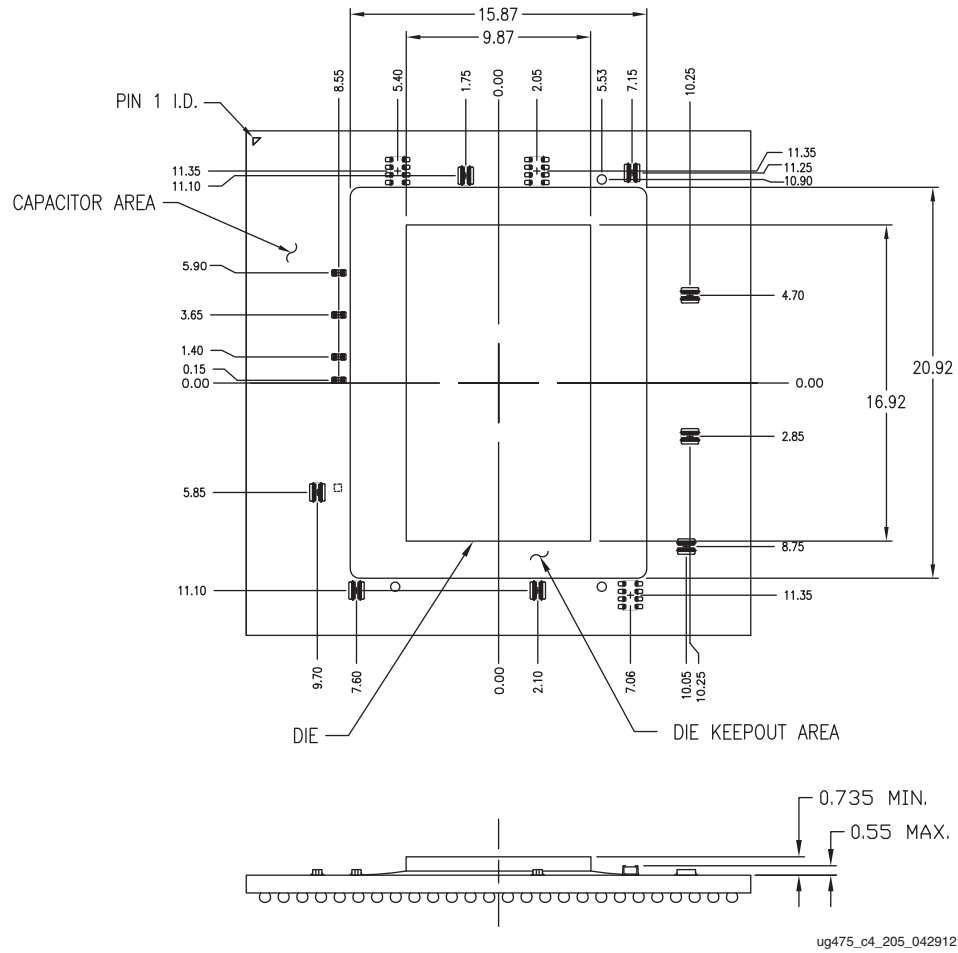

Figure 4-20: XC7K325T FB/FBG676 Die Dimensions with Capacitor Locations



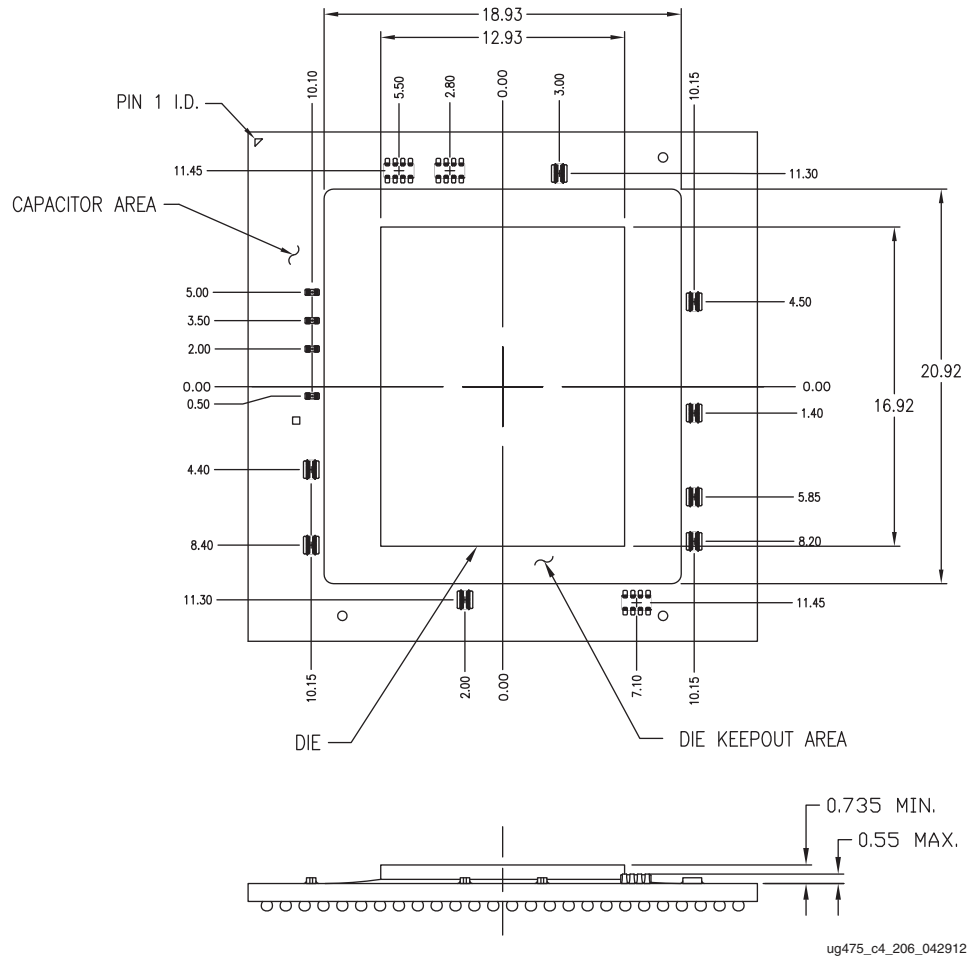
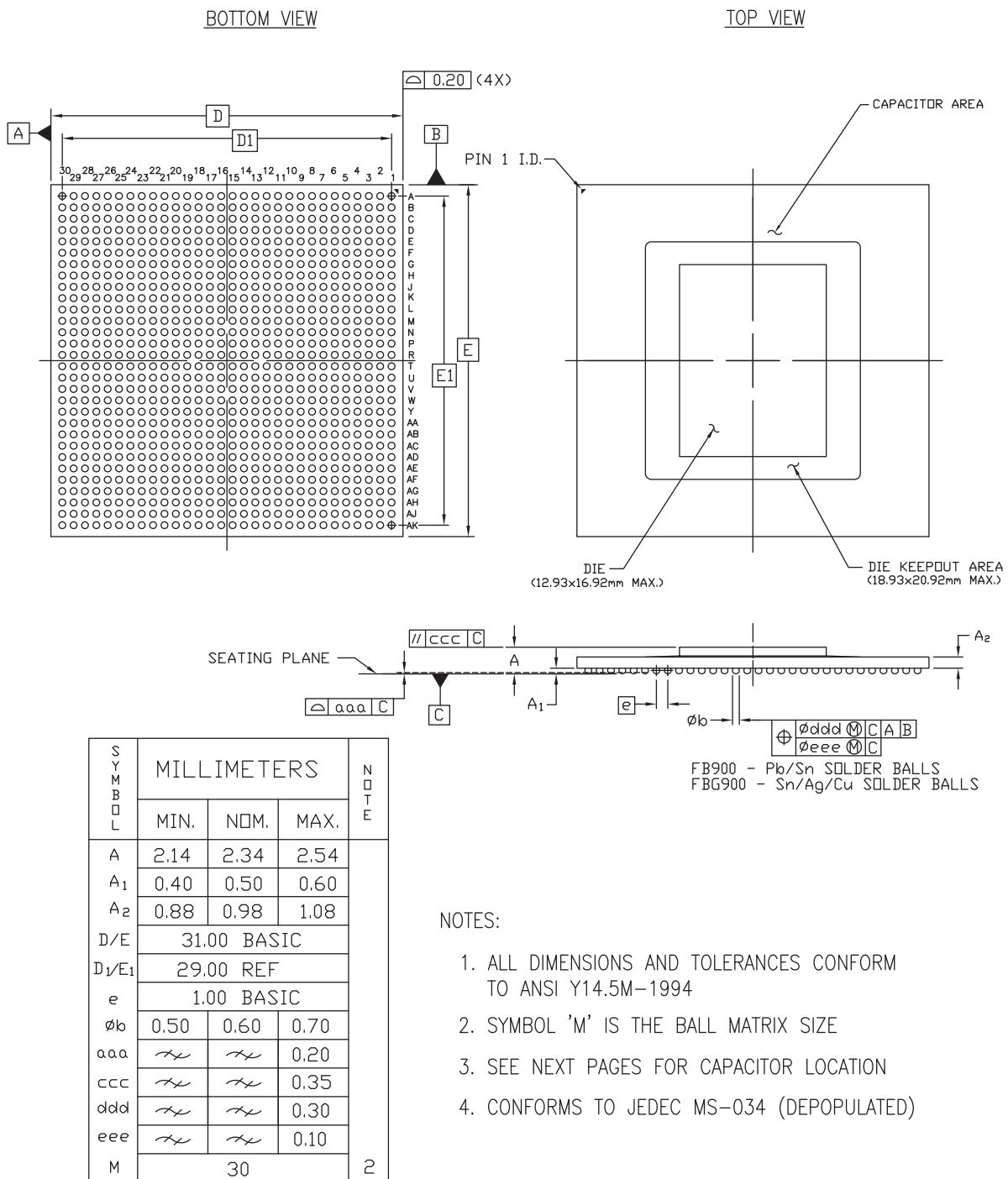

Figure 4-21: XC7K410T FB/FBG676 Die Dimensions with Capacitor Locations

## FB/FBG900 Flip-Chip Lidless BGA (Kintex-7 FPGAs) (1.0 mm Pitch)



ug475\_o4\_03\_042912

Figure 4-22: FB/FBG900 Flip-Chip Lidless BGA Package Specifications for Kintex-7 FPGAs

TOP VIEW

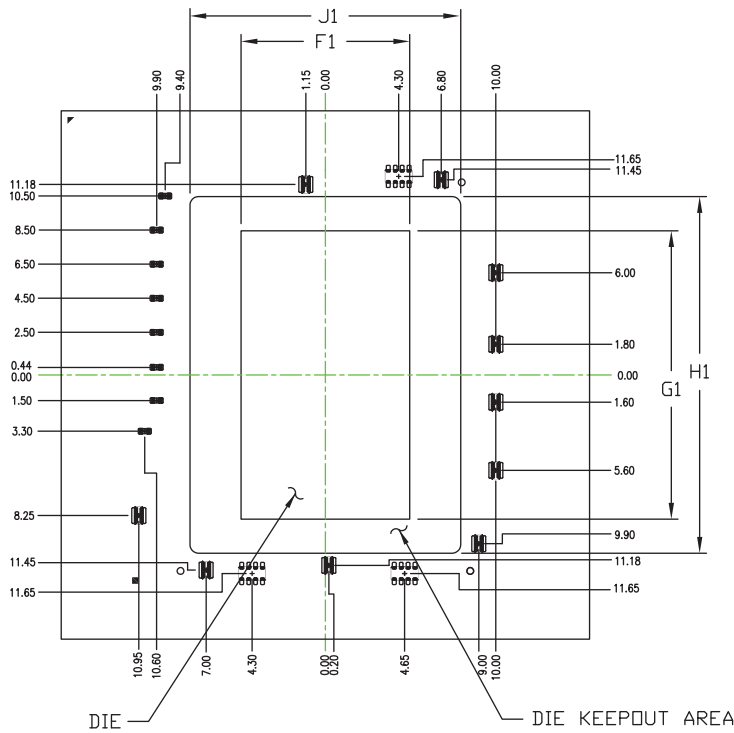

PACKAGE INFORMATION		DESCRIPTION
PACKAGE TYPE		FB900
DEVICE TYPE		XC7K325T
DEVICE SIZE (mm)	F1	9.89
	G1	16.92
DEVICE KEEPOUT AREA (mm)	J1	15.89
	H1	20.92

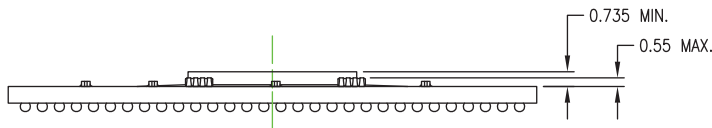

ug475\_c4\_207\_042912

Figure 4-23: XC7K325T FB/FBG900 Die Dimensions with Capacitor Locations

TOP VIEW

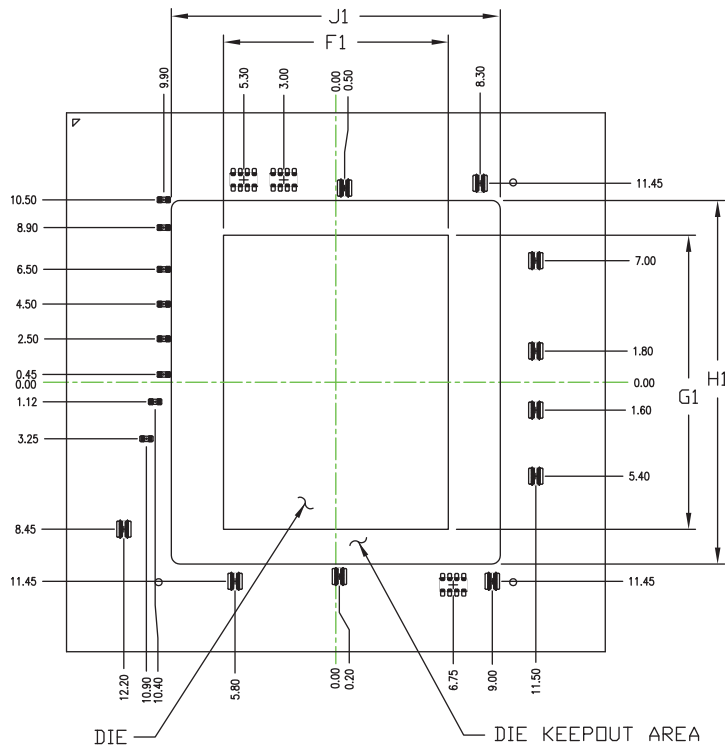

PACKAGE INFORMATION		DESCRIPTION	
PACKAGE TYPE		FB900	
DEVICE TYPE		XC7K410T	
DEVICE SIZE (mm)	F1	12.93	
	G1	16.92	
DEVICE KEEPOUT AREA (mm)	J1	18.93	
	H1	20.92	

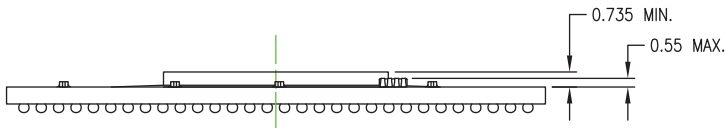

ug475\_c4\_208\_042912

Figure 4-24: XC7K410T FB/FBG900 Die Dimensions with Capacitor Locations

# FF/FFG676 Flip-Chip BGA (Kintex-7 FPGAs) (1.0 mm Pitch)

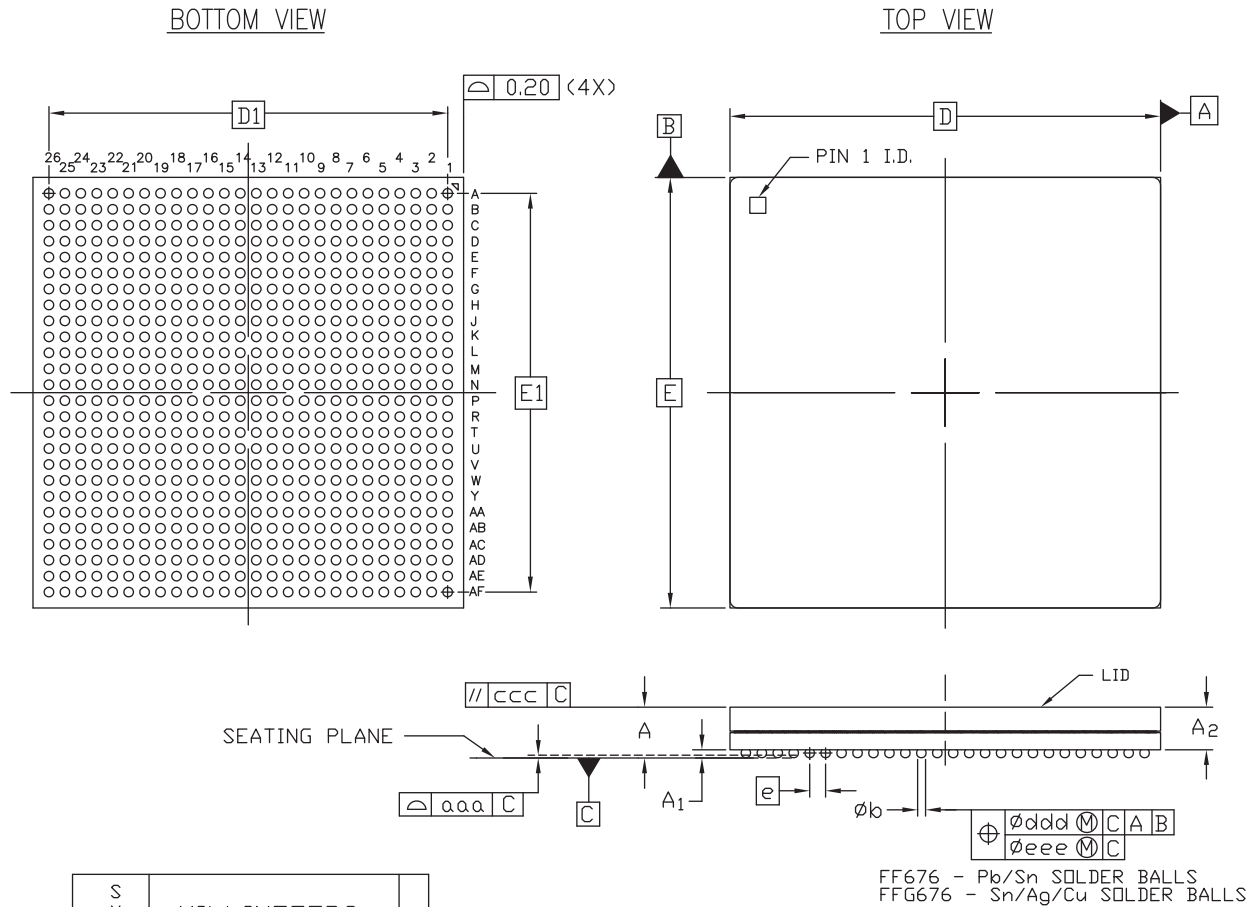

SYMBOL	MILLIMETERS			NOTE
	MIN.	NOM.	MAX.	
A	2.97	3.17	3.37	
A <sub>1</sub>	0.40	0.50	0.60	
A <sub>2</sub>	2.57	<i>∅</i>	2.77	
$\frac{D}{E}$	27.00 BASIC			
$\frac{D_1}{E_1}$	25.00 REF			
$\text{e}$	1.00 BASIC			
$\phi b$	0.50	0.60	0.70	
aaa	<i>∅</i>	<i>∅</i>	0.20	
ccc	<i>∅</i>	<i>∅</i>	0.25	
ddd	<i>∅</i>	<i>∅</i>	0.25	
eee	<i>∅</i>	<i>∅</i>	0.10	
M	26			2

NOTES:

1. ALL DIMENSIONS AND TOLERANCES CONFORM TO ANSI Y14.5M-1994
2. SYMBOL 'M' IS THE BALL MATRIX SIZE.
3. CONFORMS TO JEDEC MS-034-AAL-1

ug475\_c4\_04\_050312

Figure 4-25: FF/FFG676 Flip-Chip BGA Package Specifications for Kintex-7 FPGAs

# FF/FFG900 and FF/FFG901 Flip-Chip BGA (Kintex-7 FPGAs) (1.0 mm Pitch)

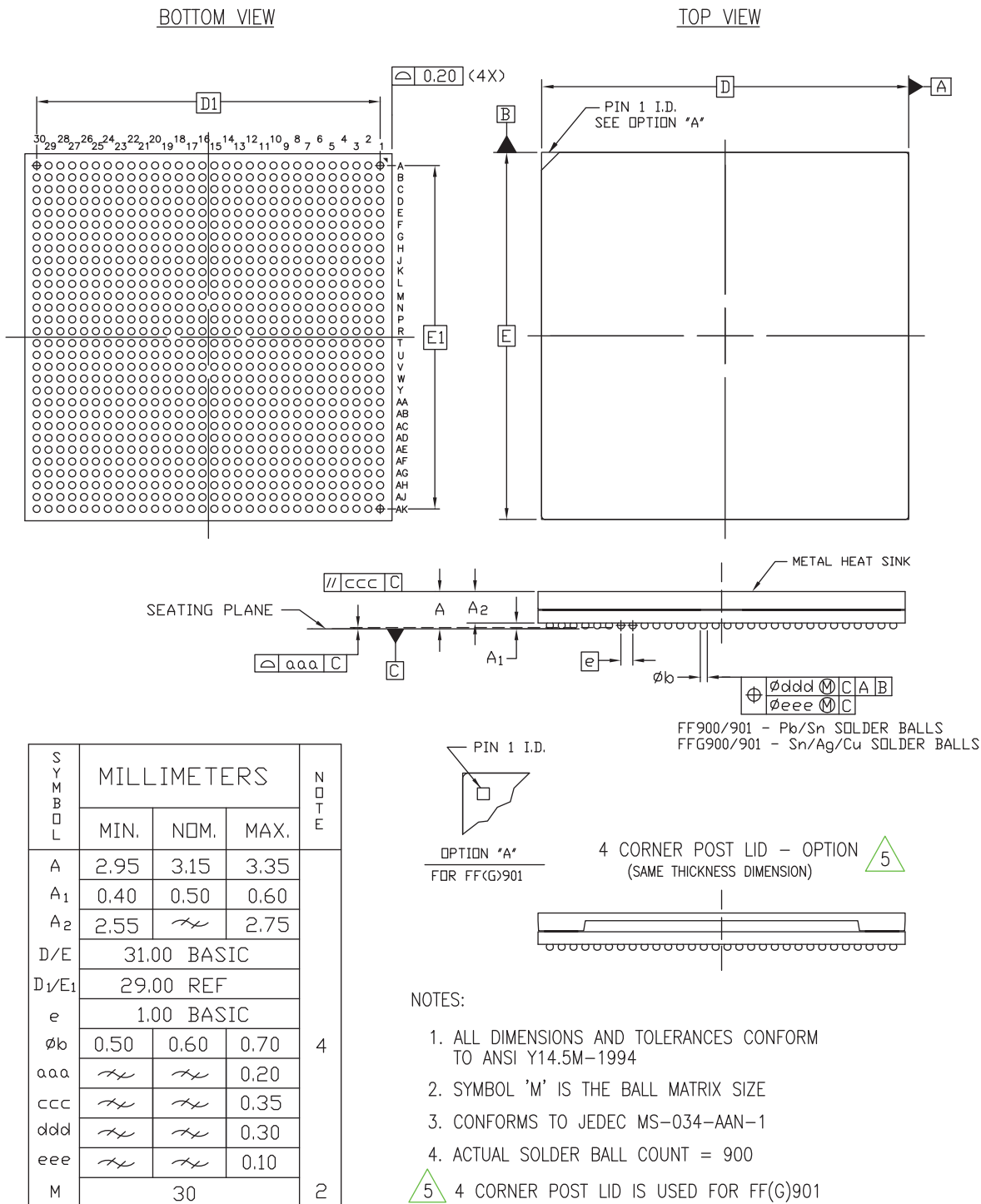

ug475\_c4\_05\_013113

Figure 4-26: FF/FFG900 and FF/FFG901 Flip-Chip BGA Package Specifications for Kintex-7 FPGAs

# FF/FFG1156 Flip-Chip BGA (Kintex-7 FPGAs) (1.0 mm Pitch)

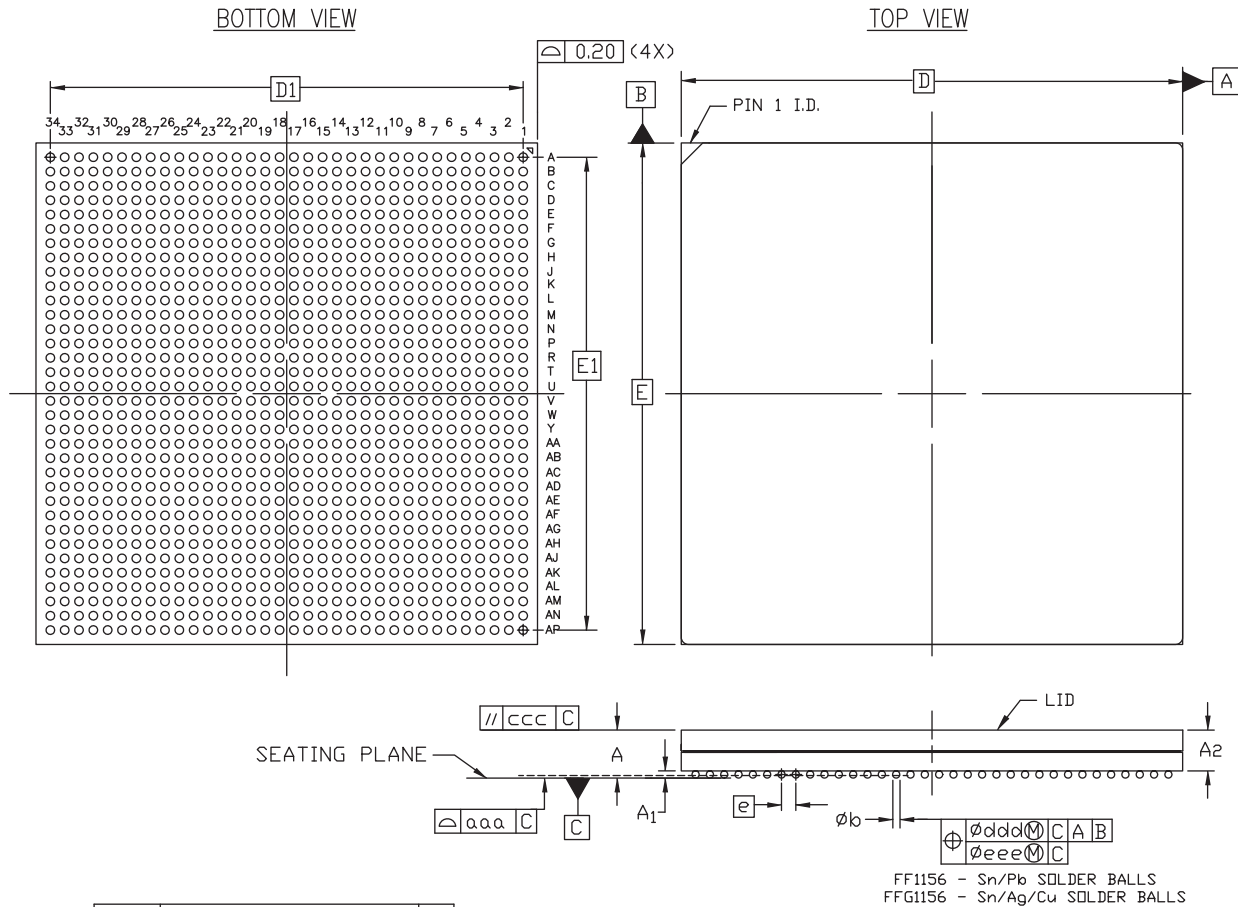

SYMBOL	MILLIMETERS			NOTE
	MIN.	NOM.	MAX.	
A	2.95	$\approx$	3.35	4
A <sub>1</sub>	0.40	0.50	0.60	
A <sub>2</sub>	2.55	$\approx$	2.75	
D/E	35.00 BASIC			
D <sub>1</sub> /E <sub>1</sub>	33.00 REF			
e	1.00 BASIC			
$\phi b$	0.50	0.60	0.70	
aaa	$\approx$	$\approx$	0.20	
ccc	$\approx$	$\approx$	0.35	
ddd	$\approx$	$\approx$	0.30	
eee	$\approx$	$\approx$	0.10	
M	34			2

NOTES:

1. ALL DIMENSIONS AND TOLERANCES CONFORM TO ANSI Y14.5M-1994
2. SYMBOL 'M' IS THE BALL MATRIX SIZE
3. CONFORMS TO JEDEC MS-034-AAR-1
4. ACTUAL SOLDER BALL COUNT = 1156
5. THIS PACKAGE IS USED FOR KINTEX<sup>®</sup>-7 FPGAs  
REFER TO PK384 FOR THE MECHANICAL DRAWING OF THE FF1156 PACKAGE USED FOR VIRTEX<sup>®</sup>-5 FPGAS  
AND PK401 FOR VIRTEX<sup>®</sup>-6 FPGAS

ug475\_o4\_07\_051512

Figure 4-27: FF/FFG1156 Flip-Chip BGA Package Specification for Kintex-7 FPGAs

## RF676 Flip-Chip BGA (Kintex-7 FPGAs) (1.0 mm Pitch)

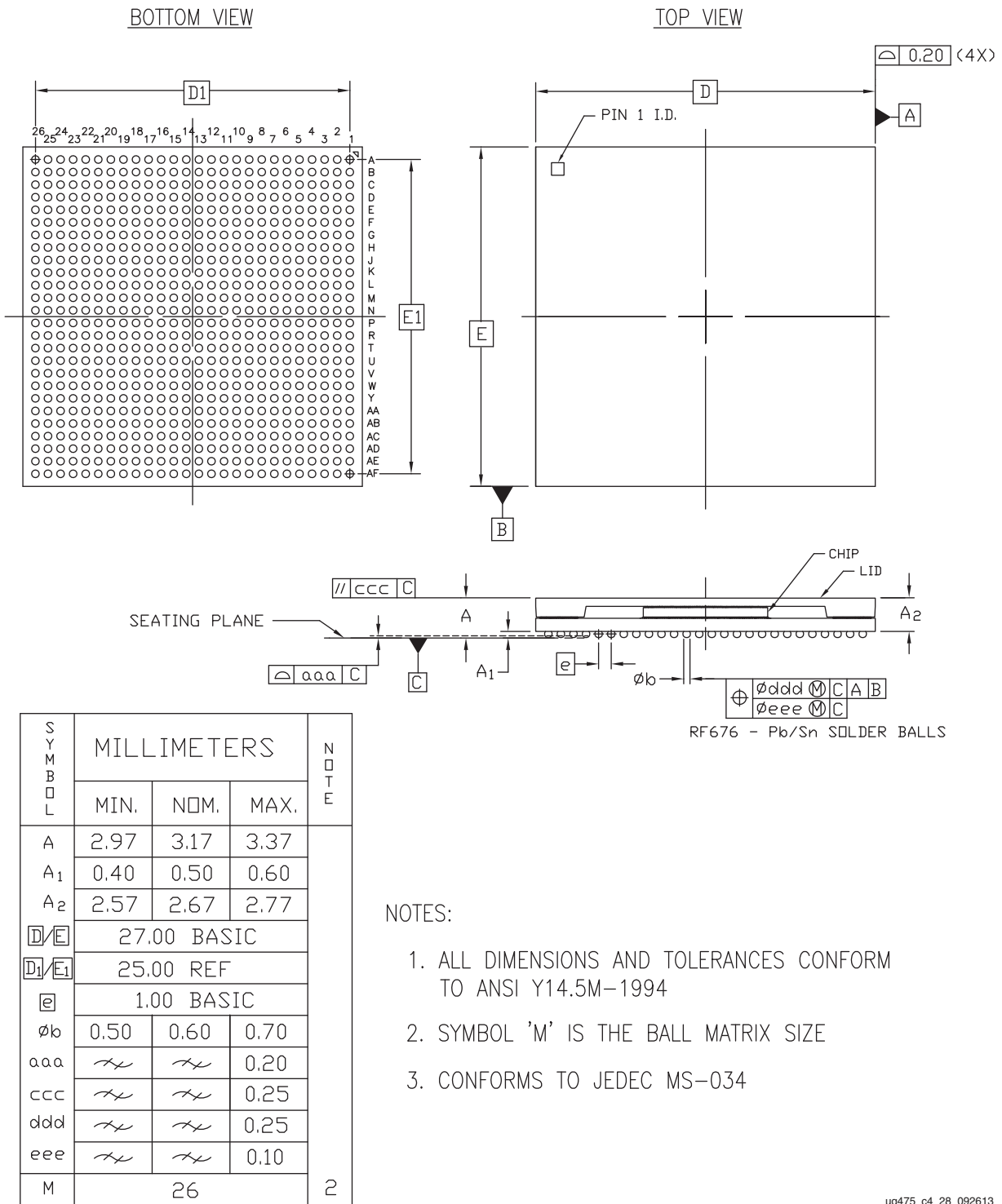
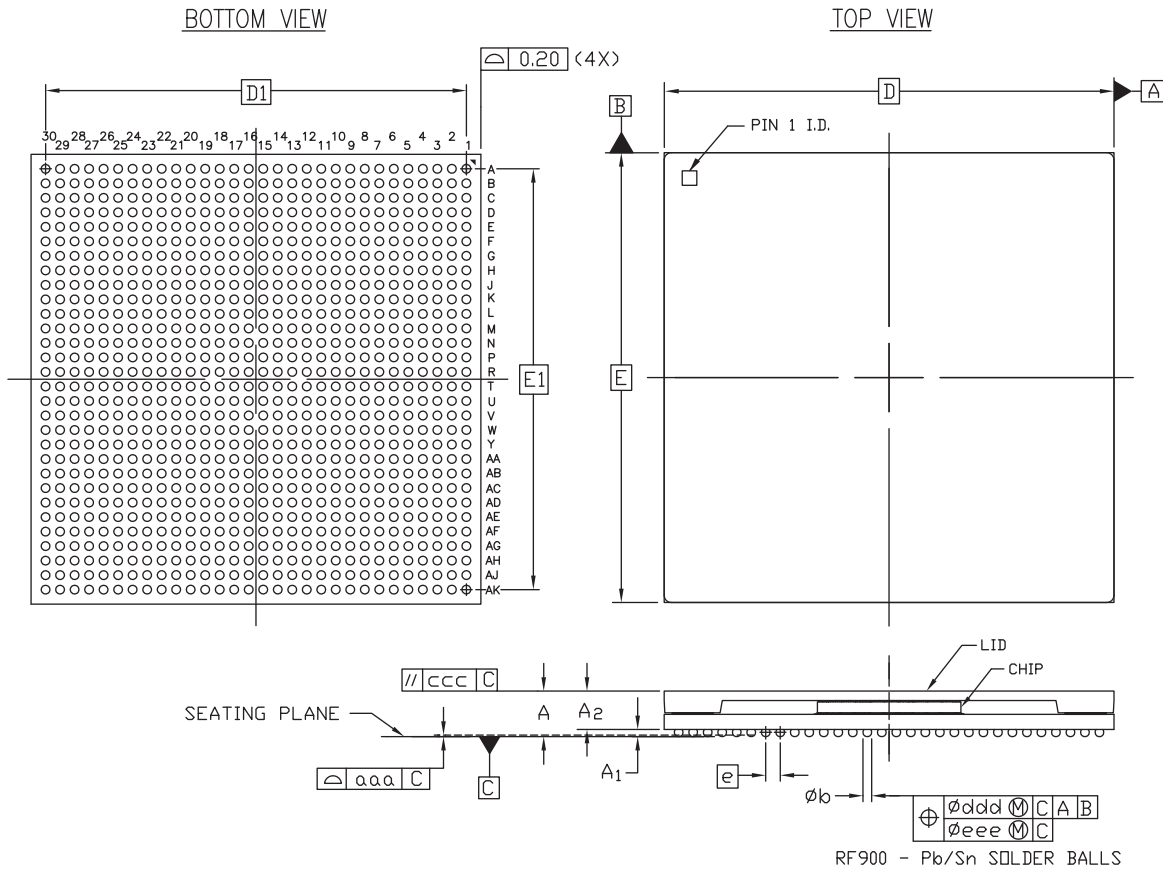

Figure 4-28: RF676 Flip-Chip BGA Package Specifications for Kintex-7 FPGAs



# RF900 Flip-Chip BGA (Kintex-7 FPGAs) (1.0 mm Pitch)



SYMBOL	MILLIMETERS			NOTE
	MIN.	NOM.	MAX.	
A	2.84	3.14	3.44	2
A <sub>1</sub>	0.40	0.50	0.60	
A <sub>2</sub>	2.44	2.64	2.84	
D/E	31.00 BASIC			
D <sub>1</sub> /E <sub>1</sub>	29.00 REF			
e	1.00 BASIC			
φ <sub>b</sub>	0.50	0.60	0.70	
aaa	<i>↗</i>	<i>↗</i>	0.20	
ccc	<i>↗</i>	<i>↗</i>	0.35	
ddd	<i>↗</i>	<i>↗</i>	0.30	
eee	<i>↗</i>	<i>↗</i>	0.10	
M	30			

NOTES:

1. ALL DIMENSIONS AND TOLERANCES CONFORM TO ANSI Y14.5M-1994
2. SYMBOL 'M' IS THE BALL MATRIX SIZE
3. CONFORMS TO JEDEC MS-034-AAN-1

ug475\_c4\_30\_092613

Figure 4-29: RF900 Flip-Chip BGA Package Specifications for Kintex-7 FPGAs

## FF/FFG1157 and FF/FFG1158 Flip-Chip BGA (Virtex-7 FPGAs) (1.0 mm Pitch)

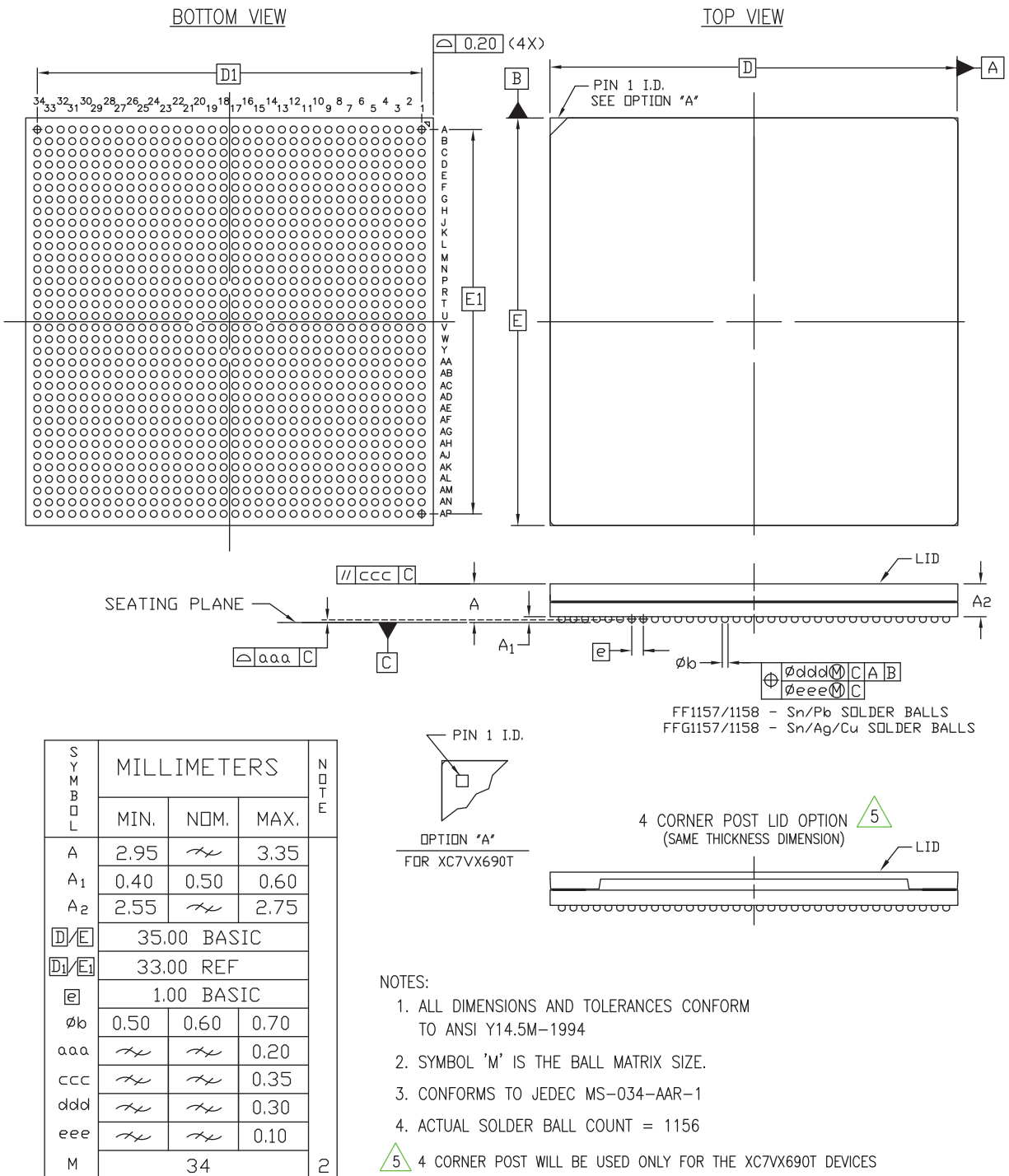

ug475\_c4\_08\_013113

Figure 4-30: FF/FFG1157 and FF/FFG1158 Flip-Chip BGA Package Specification for Virtex-7 FPGAs

# FF/FFG1761 Flip-Chip BGA (Virtex-7 FPGAs) (1.0 mm Pitch)

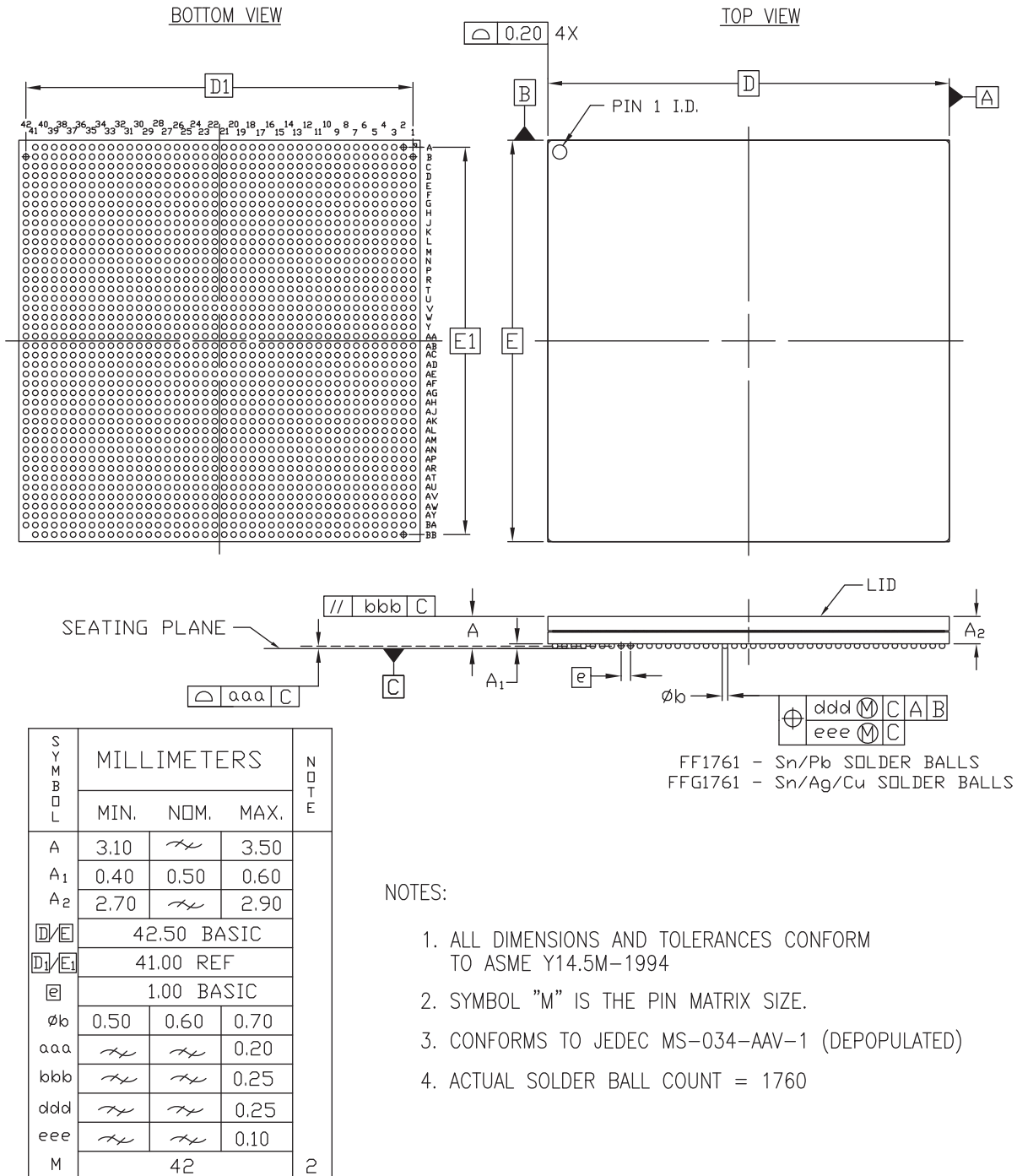

ug475\_c4\_09\_091411

Figure 4-31: FF/FFG1761 Flip-Chip BGA Package Specification for Virtex-7 FPGAs

## FH/FHG1761 Flip-Chip BGA (Virtex-7 T FPGAs) (1.0 mm Pitch)

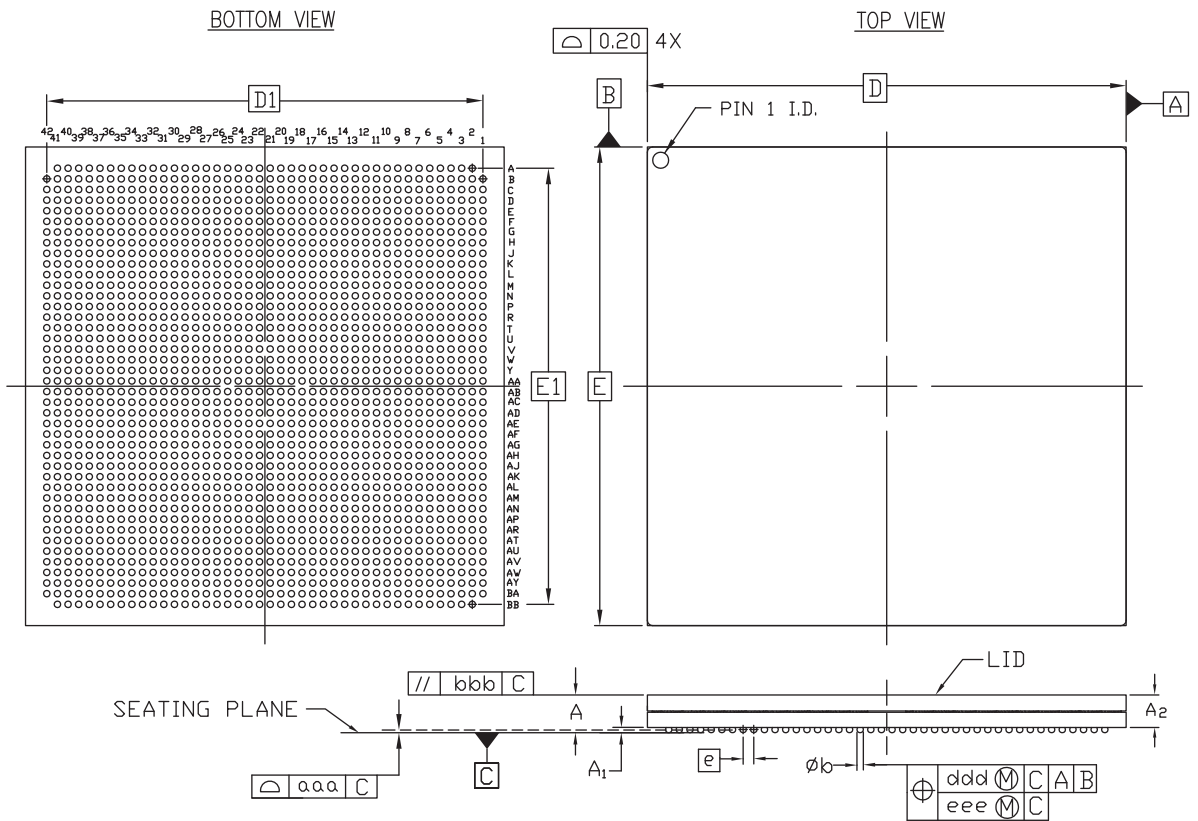

FH1761 = Pb/Sn SOLDER BALLS  
FHG1761 = Sn/Ag/Cu SOLDER BALLS

SYMBOL	MILLIMETERS			NOTE
	MIN.	NOM.	MAX.	
A	3.25	$\approx$	3.75	2
A <sub>1</sub>	0.40	0.50	0.60	
A <sub>2</sub>	2.85	$\approx$	3.15	
$D/E$	45.00 BASIC			
$D_1/E_1$	41.00 REF			
$e$	1.00 BASIC			
$\phi b$	0.50	0.60	0.70	
aaa	$\approx$	$\approx$	0.30	
bbb	$\approx$	$\approx$	0.25	
ddd	$\approx$	$\approx$	0.25	
eee	$\approx$	$\approx$	0.10	
M	42			

**NOTES:**

1. ALL DIMENSIONS AND TOLERANCES CONFORM TO ASME Y14.5M-1994
2. SYMBOL "M" IS THE PIN MATRIX SIZE.
3. CONFORMS TO JEDEC MS-034-AAV-1 (DEPOPULATED)
4. ACTUAL SOLDER BALL COUNT = 1760

ug475\_c4\_10\_092412

**Figure 4-32: FH/FHG1761 Flip-Chip BGA Package Specification for Virtex-7 T FPGAs**

# FF/FFG1926, FF/FFG1927, FF/FFG1928, and FF/FFG1930 Flip-Chip BGA (Virtex-7 XT FPGAs) (1.0 mm Pitch)

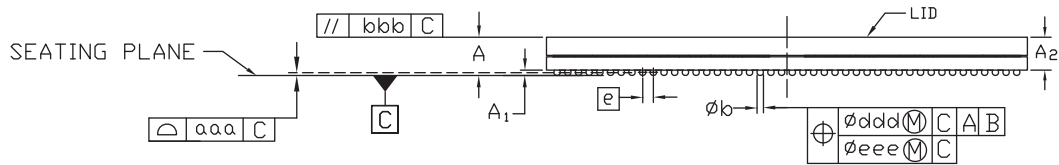
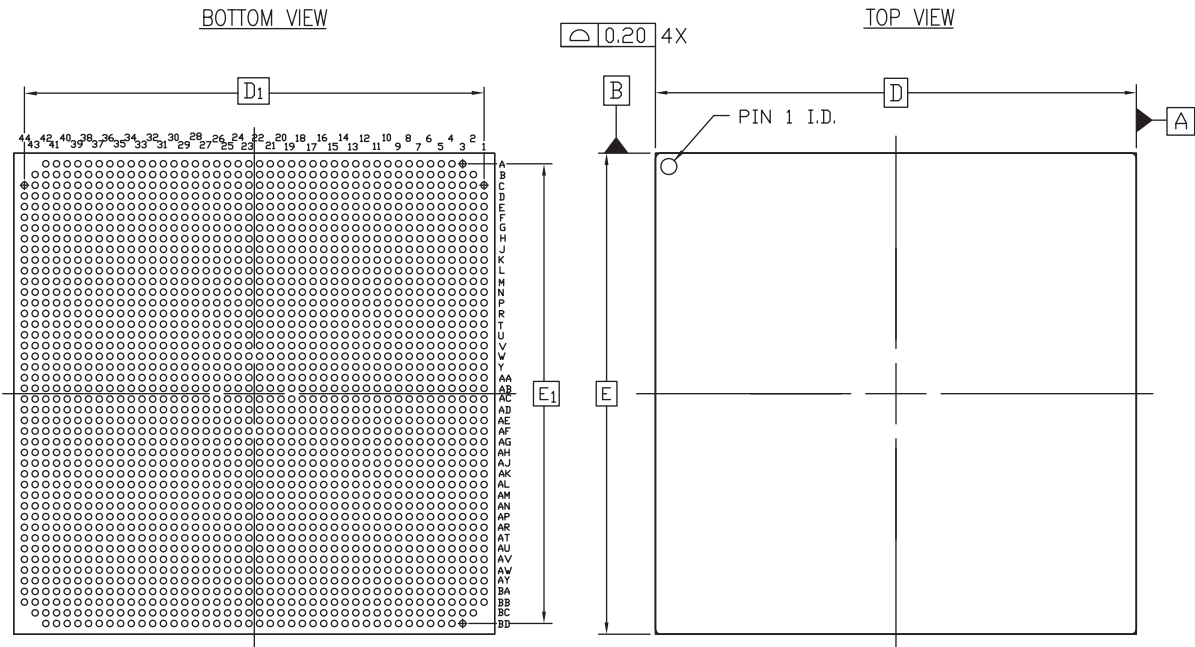

FF1926/1927/1928/1930 - Sn/Pb SOLDER BALLS  
 FFG1926/1927/1928/1930 - Sn/Ag/Cu SOLDER BALLS

SYMBOL	MILLIMETERS			NOTE
	MIN.	NOM.	MAX.	
A	3.25	$\approx$	3.65	3
A <sub>1</sub>	0.40	0.50	0.60	
A <sub>2</sub>	2.85	$\approx$	3.05	
D/E	45.00 BASIC			
D <sub>1</sub> /E <sub>1</sub>	43.00 REF			
e	1.00 BASIC			
$\phi b$	0.50	0.60	0.70	
aaa	$\approx$	$\approx$	0.20	
bbb	$\approx$	$\approx$	0.25	
ddd	$\approx$	$\approx$	0.25	
eee	$\approx$	$\approx$	0.10	
M	44			2

NOTES:

1. ALL DIMENSIONS AND TOLERANCES CONFORM TO ASME Y14.5M-1994
2. SYMBOL "M" IS THE PIN MATRIX SIZE.
3. ACTUAL SOLDER BALL COUNT = 1924
4. CONFORMS TO JEDEC MS-034-AAW-1 (DEPOPULATED)

ug475\_c4\_11\_091712

Figure 4-33: FF/FFG1926, FF/FFG1927, FF/FFG1928, and FF/FFG1930 Flip-Chip BGA Package Specification for Virtex-7 XT FPGAs

# FL/FLG1925, FL/FLG1926, FL/FLG1928, and FL/FLG1930 Flip-Chip BGA (Virtex-7 FPGAs) (1.0 mm Pitch)

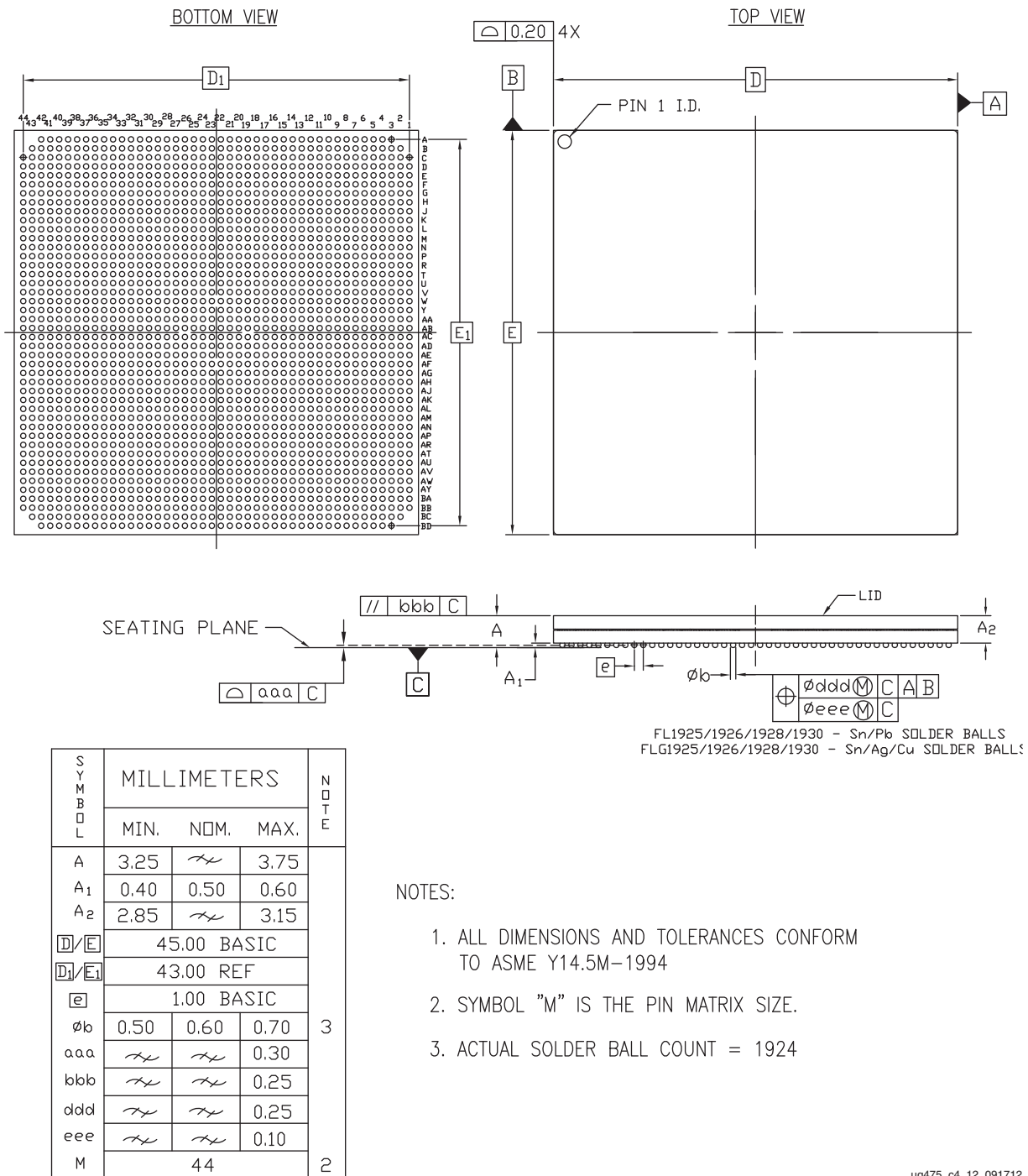

ug475\_c4\_12\_091712

Figure 4-34: FL/FLG1925, FL/FLG1926, FL/FLG1928, and FL/FLG1930 Flip-Chip BGA Package Specification for Virtex-7 FPGAs

# RF1157 Flip-Chip BGA (Virtex-7 FPGAs) (1.0 mm Pitch)

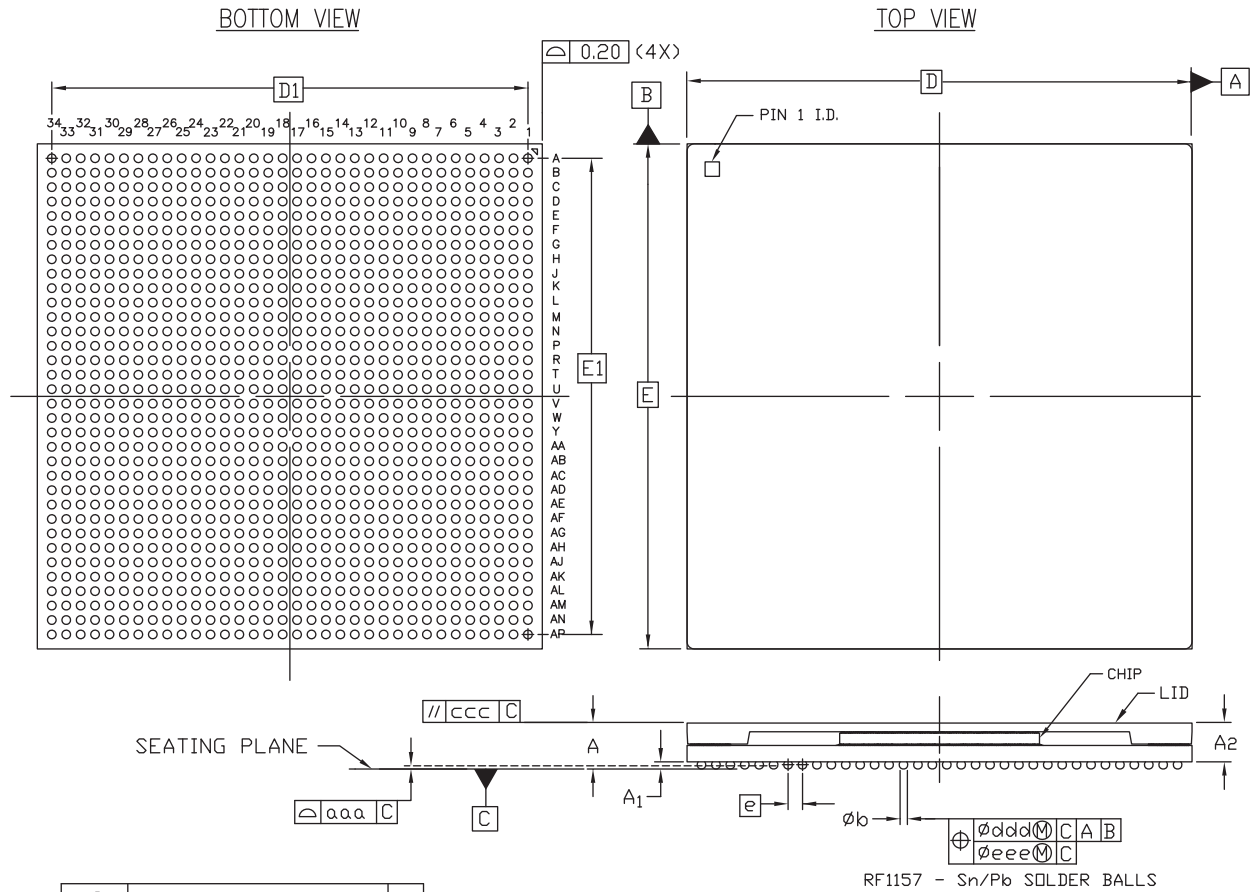

SYMBOL	MILLIMETERS			NOTE
	MIN.	NOM.	MAX.	
A	2.88	3.18	3.48	2
A <sub>1</sub>	0.40	0.50	0.60	
A <sub>2</sub>	2.48	2.68	2.88	
$\frac{D}{E}$	35.00 BASIC			
$\frac{D}{E_1}$	33.00 REF			
$\frac{e}{e}$	1.00 BASIC			
$\phi b$	0.50	0.60	0.70	
aaa	<i>∕</i>	<i>∕</i>	0.20	
ccc	<i>∕</i>	<i>∕</i>	0.35	
ddd	<i>∕</i>	<i>∕</i>	0.30	
eee	<i>∕</i>	<i>∕</i>	0.10	
M	34			

NOTES:

1. ALL DIMENSIONS AND TOLERANCES CONFORM TO ANSI Y14.5M-1994
2. SYMBOL 'M' IS THE BALL MATRIX SIZE.
3. CONFORMS TO JEDEC MS-034-AAR-1
4. ACTUAL SOLDER BALL COUNT = 1156

ug475\_c4\_209\_092613

Figure 4-35: RF1157 Flip-Chip BGA Package Specifications for Virtex-7 FPGAs

## RF1761 Flip-Chip BGA (Virtex-7 FPGAs) (1.0 mm Pitch)

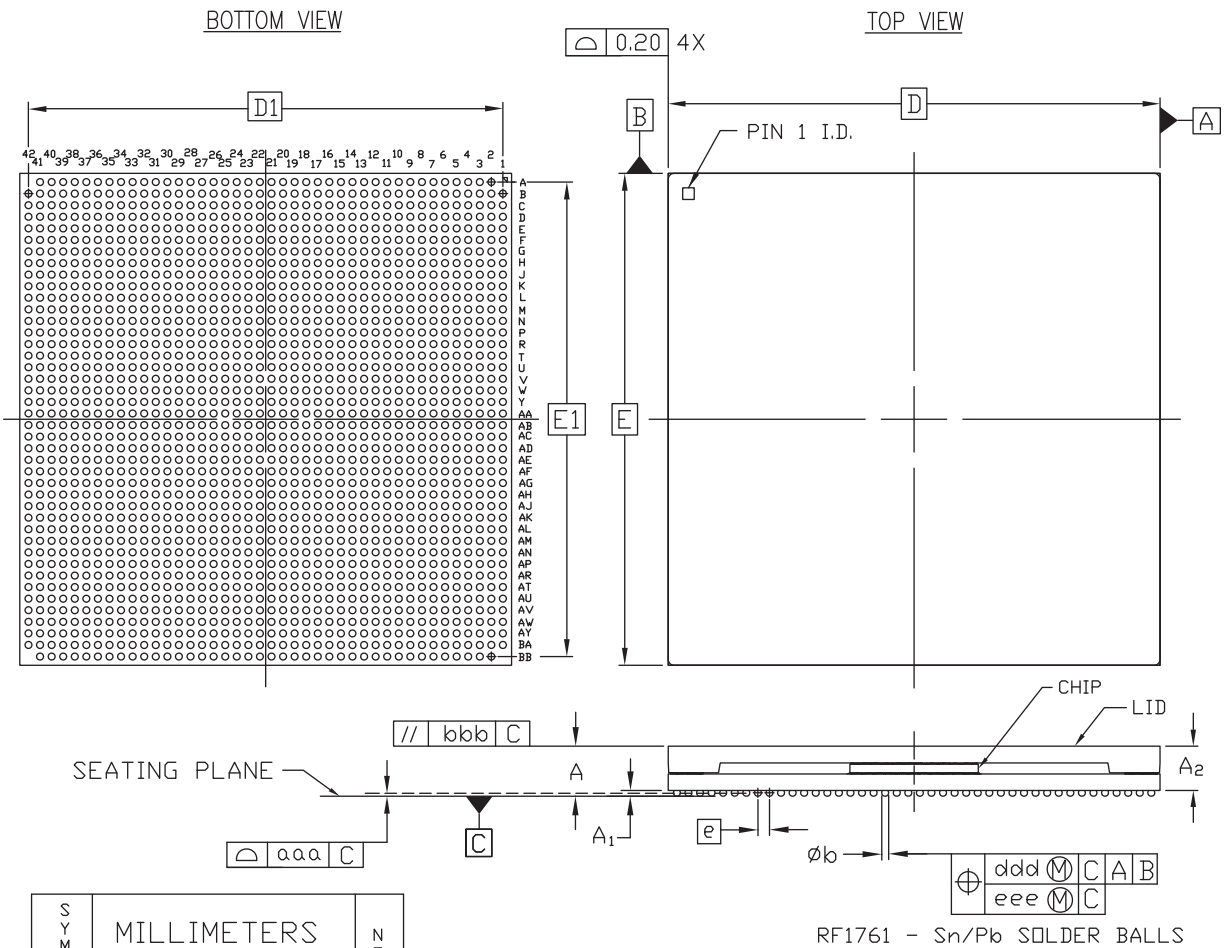

SYMBOL	MILLIMETERS			NOTE
	MIN.	NOM.	MAX.	
A	4.07	4.32	4.57	
A <sub>1</sub>	0.40	0.50	0.60	
A <sub>2</sub>	3.67	3.82	3.97	
D/E	42.50 BASIC			2
D <sub>1</sub> /E <sub>1</sub>	41.00 REF			
e	1.00 BASIC			
$\phi b$	0.50	0.60	0.70	
aaa	<i>h</i>	<i>h</i>	0.20	
bbb	<i>h</i>	<i>h</i>	0.25	
ddd	<i>h</i>	<i>h</i>	0.25	
eee	<i>h</i>	<i>h</i>	0.10	
M	42			

**NOTES:**

1. ALL DIMENSIONS AND TOLERANCES CONFORM TO ASME Y14.5M-1994
2. SYMBOL "M" IS THE PIN MATRIX SIZE.
3. CONFORMS TO JEDEC MS-034-AAV-1 (DEPOPULATED)
4. ACTUAL SOLDER BALL COUNT = 1760

ug475\_c4\_210\_092613

**Figure 4-36: RF1761 Flip-Chip BGA Package Specifications for Virtex-7 FPGAs**



# RF1930 Flip-Chip BGA (Virtex-7 FPGAs) (1.0 mm Pitch)

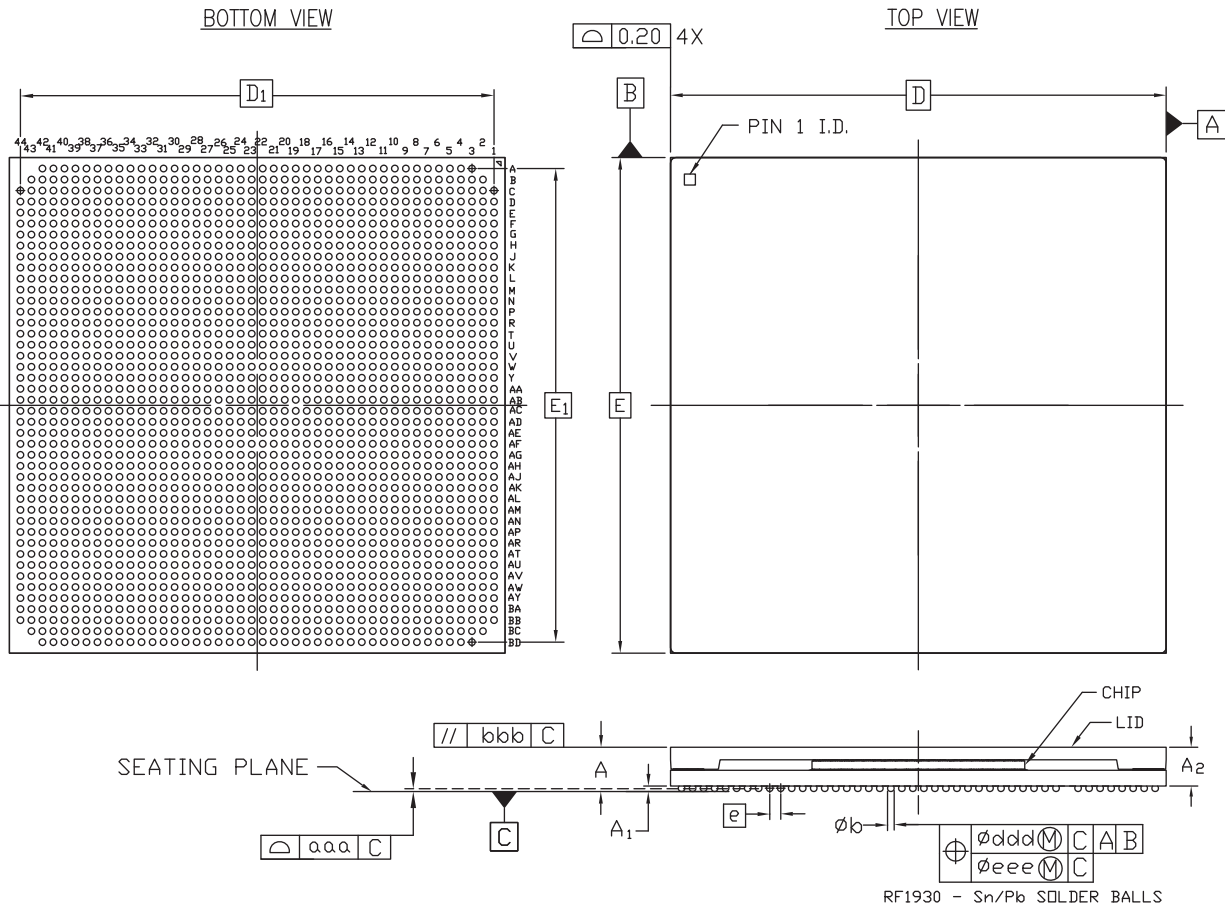

SYMBOL	MILLIMETERS			NOTE
	MIN.	NOM.	MAX.	
A	3.77	4.02	4.27	3
A <sub>1</sub>	0.40	0.50	0.60	
A <sub>2</sub>	3.37	3.52	3.67	
D/E	45.00 BASIC			2
D <sub>1</sub> /E <sub>1</sub>	43.00 REF			
e	1.00 BASIC			
φb	0.50	0.60	0.70	
aaa	<i>HL</i>	<i>HL</i>	0.20	
bbb	<i>HL</i>	<i>HL</i>	0.25	
ddd	<i>HL</i>	<i>HL</i>	0.25	
eee	<i>HL</i>	<i>HL</i>	0.10	
M	44			

NOTES:

1. ALL DIMENSIONS AND TOLERANCES CONFORM TO ASME Y14.5M-1994
2. SYMBOL "M" IS THE PIN MATRIX SIZE.
3. ACTUAL SOLDER BALL COUNT = 1924
4. CONFORMS TO JEDEC MS-034-AAW-1 (DEPOPULATED)

ug475\_c4\_211\_092613

Figure 4-37: RF1930 Flip-Chip BGA Package Specifications for Virtex-7 FPGAs



# Thermal Specifications

---

## Summary

This chapter provides thermal data associated with 7 series FPGAs packages. The following topics are discussed:

- [Introduction](#)
- [Thermal Management Strategy](#)
- [Some Thermal Management Options](#)
- [Support for Compact Thermal Models \(CTM\)](#)
- [Soldering Guidelines](#)
- [References](#)

## Introduction

7 series FPGAs are offered exclusively in thermally efficient flip-chip BGA packages. These 0.8 mm and 1.0 mm flip-chip packages range in pin-count from the smaller 15 x 15 mm CSG324 to the 45 x 45 mm FFG1930. This suite of packages is used to address the various power requirements of the 7 series devices. All 7 series devices are implemented in the 28 nm process technology.

Similar to Virtex®-6 FPGAs, all 7 series devices feature the versatile SelectIO™ resources that support a variety of I/O standards. They also include analog-to-digital converters (XADC), DSPs, and other traditional features and blocks (such as block RAM) contained in earlier Virtex products.

In line with Moore's law, the transistor count in this family of devices has been increased substantially. Though several innovative features at the silicon level have been deployed to minimize power dissipation, including leakage at the 28 nm node, these products have more densely packed transistors and embedded blocks with the capability to run faster than before. Thus, a fully configured 7 series FPGA design that exploits the fabric speed and incorporates several embedded circuits and systems can present power consumption challenges that must be managed.

Unlike features in an ASIC or a microprocessor, the combination of FPGA features used in a user application are not known to the component supplier. Therefore, it remains a challenge for Xilinx to predict the power requirements of a given FPGA when it leaves the factory. Accurate estimates are obtained when the board design takes shape. For this purpose, Xilinx offers and supports a suite of integrated device power analysis tools to help users quickly and accurately estimate their design power requirements. 7 series devices are supported similarly to previous FPGA products. The uncertainty of design power requirements makes it difficult to apply canned thermal solutions to fit all users.

Therefore, Xilinx devices do not come with preset thermal solutions. The user's operating conditions dictate the appropriate solution.

Table 5-1 shows the thermal resistance data for 7 series devices (grouped in the packages offered). The data includes junction-to-ambient in still air, junction-to-case, and junction-to-board data based on standard JEDEC four-layer measurements.

**Note:** The data in Table 5-1 is for device/package comparison purposes only. Do not apply directly to your system design. Attempts to recreate this data are only valid using the transient 2-phase measurement techniques outlined in JESD51-14.

- Thermal data is available on the Xilinx website at:  
[www.xilinx.com/cgi-bin/thermal/thermal.pl](http://www.xilinx.com/cgi-bin/thermal/thermal.pl)
- Compact package thermal models for these products are available for download on the Xilinx website (under the Device Model tab) at:  
[www.xilinx.com/support/download/index.html/content/xilinx/en/downloadNav/device-models.html](http://www.xilinx.com/support/download/index.html/content/xilinx/en/downloadNav/device-models.html)

Table 5-1: Thermal Resistance Data—All Devices

Package	Package Body Size	Devices	$\theta_{JB}$ (°C/W)	$\theta_{JA}$ (°C/W)	$\theta_{JC}$ (°C/W)	$\theta_{JA}$ -Effective (°C/W) <sup>(1)</sup>		
						@250 LFM	@500 LFM	@750 LFM
<b>Artix-7 FPGAs</b>								
CS/CSG324	15 x 15	XC7A100T	5.7	18.2	3.25	14.1	13.0	12.3
FT/FTG256	17 x 17	XC7A100T	6.9	18.2	3.34	14.1	12.9	12.2
SBG484	19 x 19	XC7A200T	5.0	14.8	0.08	10.9	9.8	9.2
RS484	19 x 19	XQ7A200T	4.7	14.2	0.33	9.9	8.7	8.0
FB/FBG484	23 x 23	XC7A200T	4.8	13.9	0.08	9.9	8.9	8.3
FG/FGG484	23 x 23	XC7A100T	6.8	15.8	3.85	12.1	11.0	10.4
RB484	23 x 23	XQ7A200T	4.0	12.5	0.26	8.3	7.2	6.7
FB/FBG676	27 x 27	XC7A200T	4.7	13.0	0.08	9.2	8.2	7.7
FG/FGG676	27 x 27	XC7A100T	6.8	15.0	3.71	11.2	10.2	9.7
RB676	27 x 27	XQ7A200T	3.7	11.4	0.33	7.3	6.2	5.6
FF/FFG1156	35 x 35	XC7A200T	2.6	9.3	0.32	6.1	5.2	4.7
<b>Kintex-7 FPGAs</b>								
FB/FBG484	23 x 23	XC7K70T	6.8	16.4	0.13	11.7	10.7	10.1
		XC7K160T	5.3	14.6	0.10	10.5	9.5	8.9
FB/FBG676	27 x 27	XC7K70T	6.7	15.7	0.13	11.8	10.8	10.2
		XC7K160T	5.2	14.0	0.10	9.8	8.8	8.3
		XC7K325T	4.2	12.9	0.06	8.9	8.0	7.5
		XC7K410T	3.7	12.2	0.05	8.6	7.6	7.1

Table 5-1: Thermal Resistance Data—All Devices (Cont'd)

Package	Package Body Size	Devices	$\theta_{JB}$ (°C/W)	$\theta_{JA}$ (°C/W)	$\theta_{JC}$ (°C/W)	$\theta_{JA}$ -Effective (°C/W) <sup>(1)</sup>		
						@250 LFM	@500 LFM	@750 LFM
FF/FFG676	27 x 27	XC7K160T	4.0	11.7	0.41	7.5	6.4	5.8
		XC7K325T	3.5	11.1	0.26	7.3	6.3	5.8
		XC7K410T	3.3	10.9	0.20	7.0	6.0	5.5
RF676	27 x 27	XQ7K325T	3.5	11.1	0.26	7.3	6.3	5.8
		XQ7K410T	3.3	10.9	0.20	7.0	6.0	5.5
FB/FBG900	31 x 31	XC7K325T	4.3	12.00	0.06	8.90	7.90	7.30
		XC7K410T	3.7	11.4	0.05	8.3	7.3	6.7
FF/FFG900	31 x 31	XC7K325T	2.8	9.7	0.26	6.2	5.4	5.0
		XC7K410T	2.6	9.5	0.19	6.0	5.2	4.9
RF900	31 x 31	XQ7K325T	3.3	10.0	0.26	6.4	5.4	4.9
		XQ7K410T	3.0	9.8	0.20	6.3	5.4	4.9
FF/FFG901	31 x 31	XC7K355T	3.2	10.0	0.23	6.3	5.3	4.8
		XC7K420T	2.9	9.6	0.17	6.2	5.3	4.8
		XC7K480T	2.9	9.6	0.17	6.2	5.3	4.8
FF/FFG1156	35 x 35	XC7K420T	2.4	8.7	0.17	5.7	4.7	4.3
		XC7K480T	2.4	8.7	0.17	5.7	4.7	4.3
<b>Virtex-7 T FPGAs</b>								
FF/FFG1157	35 x 35	XC7V585T	2.3	8.7	0.14	5.6	4.8	4.3
RF1157	35 x 35	XQ7V585T	2.7	8.9	0.15	5.8	4.8	4.3
FF/FFG1761	42.5 x 42.5	XC7V585T	2.1	7.6	0.11	4.9	4.1	3.7
RF1761	42.5 x 42.5	XQ7V585T	2.4	7.8	0.11	4.9	4.0	3.5
FH/FHG1761	45 x 45	XC7V2000T	2.0	7.0	0.05	4.3	3.5	3.1
FL/FLG1925	45 x 45	XC7V2000T	1.7	6.9	0.06	4.2	3.4	3.0

Table 5-1: Thermal Resistance Data—All Devices (Cont'd)

Package	Package Body Size	Devices	$\theta_{JB}$ (°C/W)	$\theta_{JA}$ (°C/W)	$\theta_{JC}$ (°C/W)	$\theta_{JA}$ -Effective (°C/W) <sup>(1)</sup>		
						@250 LFM	@500 LFM	@750 LFM
<b>Virtex-7 XT FPGAs</b>								
FF/FFG1157	35 x 35	XC7VX330T	2.5	8.9	0.19	5.8	4.9	4.5
		XC7VX415T	2.3	8.8	0.16	5.7	4.8	4.4
		XC7VX485T	2.3	8.7	0.13	5.6	4.7	4.3
		XC7VX690T	2.3	8.7	0.09	5.5	4.6	4.1
RF1157	35 x 35	XQ7VX330T	2.9	9.3	0.19	6.0	5.0	4.4
		XQ7VX690T	2.3	8.7	0.09	5.3	4.4	3.9
FF/FFG1158	35 x 35	XC7VX415T	2.3	8.8	0.16	5.7	4.8	4.4
		XC7VX485T	2.3	8.7	0.13	5.6	4.7	4.3
		XC7VX550T	2.3	8.7	0.09	5.5	4.6	4.1
		XC7VX690T	2.3	8.7	0.09	5.5	4.6	4.1
FF/FFG1761	42.5 x 42.5	XC7VX330T	2.3	7.8	0.19	5.1	4.3	3.9
		XC7VX485T	2.1	7.6	0.13	4.9	4.1	3.6
		XC7VX690T	1.9	7.5	0.09	4.7	3.9	3.5
RF1761	42.5 x 42.5	XQ7VX485T	2.3	7.7	0.14	4.8	3.9	3.4
		XQ7VX330T	2.7	8.0	0.20	5.0	4.1	3.6
		XQ7VX690T	2.1	7.5	0.09	4.7	3.8	3.3
FF/FFG1926	45 x 45	XC7VX690T	1.9	7.1	0.09	4.5	3.7	3.3
		XC7VX980T	1.8	7.1	0.09	4.4	3.6	3.2
FF/FFG1927	45 x 45	XC7VX415T	2.1	7.4	0.16	4.7	3.9	3.5
		XC7VX485T	2.0	7.3	0.13	4.6	3.8	3.4
		XC7VX550T	1.8	7.1	0.09	4.4	3.6	3.2
		XC7VX690T	1.8	7.1	0.09	4.4	3.6	3.2
FF/FFG1928	45 x 45	XC7VX980T	1.8	7.1	0.09	4.4	3.6	3.2
FF/FFG1930	45 x 45	XC7VX485T	2.0	7.3	0.13	4.8	3.9	3.5
		XC7VX690T	1.9	7.1	0.09	4.5	3.7	3.3
		XC7VX980T	1.8	7.1	0.09	4.4	3.6	3.2
RF1930	45 x 45	XQ7VX485T	2.4	7.5	0.14	4.8	3.9	3.5
		XQ7VX690T	2.2	7.3	0.10	4.5	3.6	3.1
		XQ7VX980T	2.1	7.3	0.09	4.5	3.6	3.1
FL/FLG1926	45 x 45	XC7VX1140T	1.7	6.9	0.06	4.2	3.4	3.0
FL/FLG1928	45 x 45	XC7VX1140T	1.7	6.9	0.06	4.2	3.4	3.0

Table 5-1: Thermal Resistance Data—All Devices (Cont'd)

Package	Package Body Size	Devices	$\theta_{JB}$ (°C/W)	$\theta_{JA}$ (°C/W)	$\theta_{JC}$ (°C/W)	$\theta_{JA-Effective}$ (°C/W) <sup>(1)</sup>		
						@250 LFM	@500 LFM	@750 LFM
FL/FLG1930	45 x 45	XC7VX1140T	1.7	6.9	0.06	4.2	3.4	3.0

**Notes:**

1. All  $\theta_{JA-Effective}$  values assume no heat sink and include thermal dissipation through a standard JEDEC four-layer board. The Xilinx power estimation tools (PPE, Vivado® Power Analysis, and Xilinx Power Estimator), which require detailed board dimensions and layer counts, are useful for deriving more precise  $\theta_{JA-Effective}$  values.

## Thermal Management Strategy

As described in this section, Xilinx relies on a multi-pronged approach with regards to the heat-dissipating potential of 7 series devices.

### Design and Silicon

Power consumption reduction when using 28 nm node 7 series devices is achieved through innovative process and circuit design. For example, transistor static leakage current is minimized by more than 50% by deploying the multi-gate oxide transistors in the power-efficient 7 series architecture.

Despite these improvements and a low operating voltage, the base transistor counts are still large; 7 series devices pack high gate densities. Still, when comparing previous silicon generations, a 7 series FPGA programmable logic implementation has lower power consumption.

However, the increased resources and functionality associated with higher gate density devices and faster switching programmable logic resources implies increased computation with less delay. Also associated with this improved functionality is the potential for better power dissipation due to the silicon and device-based innovations.

## Cavity-Up Plastic BGA Packages

BGA is a plastic package technology that utilizes area array solder balls at the bottom of the package to make electrical contact with the circuit board in the users system. The area array format of solder balls reduces package size considerably when compared to leaded products. It also results in improved electrical performance as well as having higher manufacturing yields. The substrate is made of a multi-layer BT (bismaleimide triazene) epoxy-based material. Power and GND pins are grouped together and signal pins are assigned to the perimeter for ease of routing on the board. The package is offered in a die-up format and contains a wire-bond device covered with a mold compound. As shown in the cross section of [Figure 5-1](#), the BGA package contains a wire-bond die on a single-core printed circuit board with an overmold.

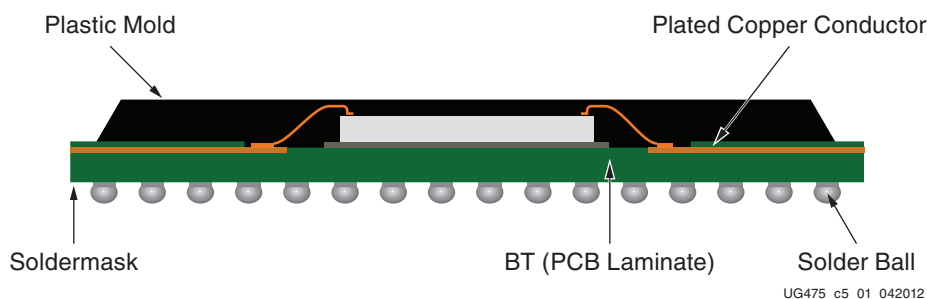

**Figure 5-1: Cavity-Up Ball Grid Array Package**

The key features/advantages of cavity-up BGA packages are:

- Low profile and small footprint
- Enhanced thermal performance
- Excellent board-level reliability



## Wire-Bond Packages

Wire-bond packages meet the demands required by miniaturization while offering improved performance. Applications for wire-bond packages are targeted to portable and consumer products where board space is of utmost importance, miniaturization is a key requirement, and power consumption/dissipation must be low. By employing 7 series FPGA wire-bond packages, system designers can dramatically reduce board area requirements. Xilinx wire-bond packages are rigid BT-based substrates (see Figure 5-2).

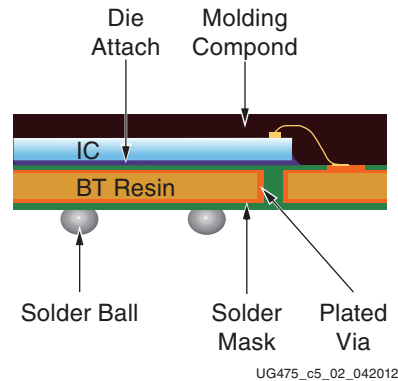

Figure 5-2: Rigid BT-Based Substrate Wire-Bond Packages

The key features/advantages of wire-bond packages are:

- An extremely small form factor which significantly reduces board area requirements for portable and wireless designs and PC add-in card applications.
- Lower inductance and lower capacitance
- The absence of thin, fragile leads found on other small package types
- A very thin, light-weight package

## Flip-Chip Packages

For larger 7 series devices, Xilinx offers the flip-chip BGA packages, which present a low thermal path. These packages incorporate a heat spreader with additional thermal interface material (TIM), as shown in Figure 5-3.

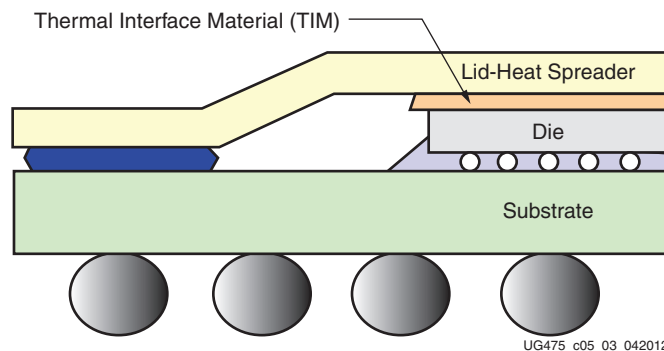

Figure 5-3: Heat Spreader with Thermal Interface Material

Materials with better thermal conductivity and consistent process applications deliver low thermal resistance up to the heat spreader. The junction-to-case thermal resistance (top of heat spreader) of all 7 series FPGA packages is typically less than  $0.20^{\circ}\text{C}/\text{W}$ . These packages deliver a low resistance platform for heat-sink applications.

A parallel effort to ensure optimized package electrical return paths produces the added benefit of enhanced power and ground plane arrangement in the packages. A boost in copper density on the planes improves the overall thermal conductivity through the laminate. In addition, the extra dense and distributed via fields in the package increase the vertical thermal conductivity. These packages offer up to 20% lower  $\theta_{\text{JB}}$  compared to previous flip-chip packages.

## Heat Sink Solutions at the System Level

Depending on the system's physical as well as mechanical constraints, the expectation is that an overall thermal budget is maintained with custom or OEM heat sink solutions, thus providing the third prong in the thermal management strategy. A heat-sink solution is managed by the system-level designer to tailor the design and solution to the specific system constraints with knowledge of the device's inherent capabilities for delivering heat to the surface. Heat-sink solutions are available and can be effective on these low  $\theta_{\text{JB}}$  flip-chip platforms.

The packages used by 7 series devices can be described as medium or high-performance packages based on their power handling capabilities. All 7 series FPGA packages can benefit by using thermal enhancements, ranging from simple airflow calculations to schemes that include passive as well as active heat sinks. This is particularly true for the larger flip-chip BGA packages where system designers have the option to further enhance the packages with larger, more elaborate heat sinks to handle excesses of 25W with arrangements that consider both system and physical constraints.

## Some Thermal Management Options

The flip-chip thermal management chart in [Figure 5-4](#) illustrates incremental power management schemes that can be applied on a flip-chip BGA package.

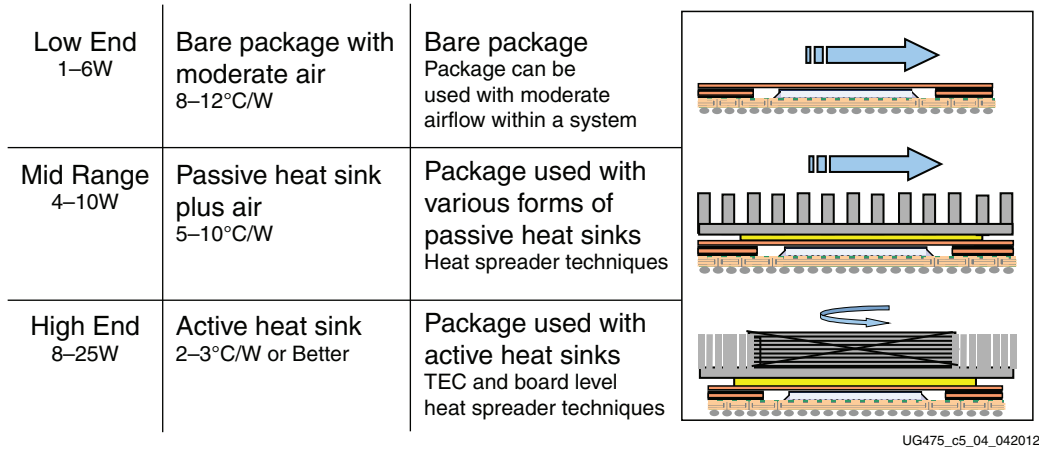

**Figure 5-4: Thermal Management Options for Flip-Chip BGA Packages**

- For moderate power dissipation (less than 6W), the use of passive heat sinks and heat spreaders attached with thermally conductive double-sided tapes or retainers (with TIM around 0.2°C/W) offer quick thermal solutions in flip-chip BGA packages.
- The use of lightweight, finned, external, and passive heat sinks can be effective for dissipating up to 10-25W in the larger packages. Since the more efficient external heat sinks tend to be tall and heavy, additional design considerations can help protect component joints from heat sink induced stress cracks. Whenever a bulky heat sink is considered it is advisable to use spring-loaded pins or clips that transfer the mounting stress to a circuit board.
- The flip-chip BGA packages offered for 7 series devices are thermally enhanced BGAs with the die facing down (see [Note](#)). These packages have an exposed metal heat sink at the top. These high-end thermal packages lend themselves to the application of efficient external heat sinks (passive or active) for further heat removal efficiency. Precautions must be taken to prevent component damage when a bulky heat sink is attached. The thermal interface resistance needs to be controlled to take full advantage of these packages.

**Note:** Lidless (FB) packages are not thermally enhanced. See guidelines for applying heat sinks to lidless packages in [Appendix B, Heat Sink Guidelines for Lidless Flip-Chip Packages](#).

- An active heat sink can include a simple heat sink incorporating a mini fan or even a Peltier Thermoelectric Cooler (TEC) with a fan to carry away any dissipated heat. When considering the use of a TEC for heat management, it is important to consult with experts about using the device because these devices can be reversed and cause damage to components. Also condensation can be an issue with these devices.
- The printed circuit board with a mounted device can have a significant impact on thermal performance. As much as 60 to 80% of the heat dissipated can go through the BGA balls directly to the board. A typical systems board is larger than the standard 4 x 4 inch JEDEC thermal board. Components mounted on these boards, with multiple copper layers and several internal vias, show low effective junction-to-ambient thermal resistances.

Table 5-2 shows this impact as an FF1156 flip-chip package's effective junction to ambient resistance is changed depending on the mounting board.

Table 5-2: Impact of Mounted Board Characteristics on  $\theta_{JA}$ (FF1156)

		$\theta_{JA}$ ( $^{\circ}\text{C/W}$ ) for Different Board Sizes		
		4 x 4 in	10 x 10 in	20 x 20 in
Layer Count of Mounted Board	4	9.1 <sup>(1)</sup>	8.3	–
	8	8.0	5.5	4.9
	12	7.5	4.7	4.4
	16	7.2	4.5	4.2
	24	–	4.3	4.0

**Notes:**

1. Base JEDEC Mount Conditions

- Designs can be implemented to take advantage of the board's ability to spread heat. The effect of the board depends on its size and how it conducts heat. Board size, the level of copper traces, and the number of buried copper planes all lower the junction-to-ambient thermal resistance for a package mounted on the board. The cold ring junction-to-board thermal data for 7 series FPGA packages is listed in Table 5-1. Users must be aware that a direct heat path to the board from a component also exposes the component to the effect of other heat sources on the board, particularly if the board is not cooled effectively. An otherwise ambient component can be heated by other heat contributing components on the board.

## Support for Compact Thermal Models (CTM)

Table 5-1 provides the traditional thermal resistance data for 7 series devices. These resistances are measured using a prescribed JEDEC standard that might not necessarily reflect the user's actual board conditions and environment. The quoted  $\theta_{JA}$  and  $\theta_{JC}$  numbers are environmentally dependent, and JEDEC has traditionally recommended that these be used with that awareness. For more accurate junction temperature prediction, these might not be enough, and a system-level thermal simulation might be required. Though Xilinx continues to support these figure of merit data, for 7 series FPGAs, boundary conditions independent compact thermal models (BCI-CTM) are also available to assist users in their thermal simulations.

Two-resistor as well as eight to ten-resistor network models are offered for all 7 series devices. These compact models seek to capture the thermal behavior of the packages more accurately at predetermined critical points (junction, case, top, leads, and so on) with the reduced set of nodes as illustrated in Figure 5-5.

Unlike a full 3D model, these are computationally efficient and work well in an integrated system simulation environment. Delphi CTM models are available for download on the Xilinx website (under the Device Model tab) at:

[www.xilinx.com/support/download/index.html/content/xilinx/en/downloadNav/device-models.html](http://www.xilinx.com/support/download/index.html/content/xilinx/en/downloadNav/device-models.html)

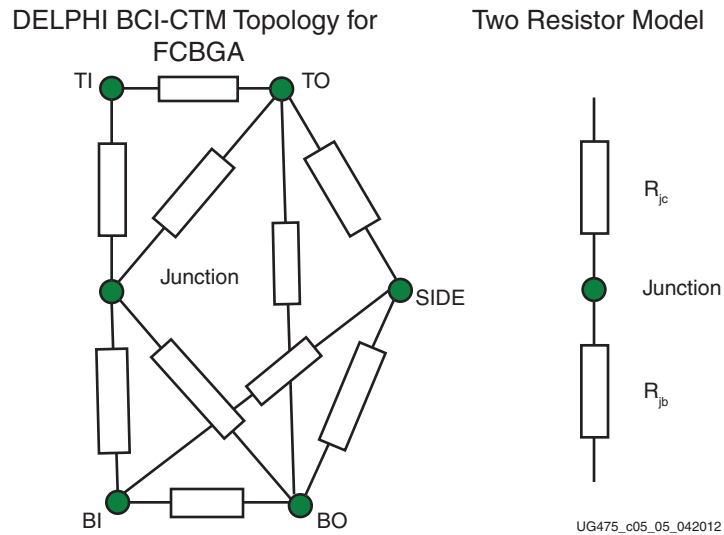

Figure 5-5: Thermal Model Topologies

The CTM models are based on the DELPHI approach that JEDEC has proposed. Since the JEDEC neutral (XML) format proposal has not been adopted yet, the DELPHI approach is used to generate these files and the data saved in the NATIVE and proprietary file formats of the targeted CFD tools - rather than follow a neutral file format. The CTM libraries are available in Flotherm (PDML) format – good for V5.1 and above and Icepack (version 4.2 and above) format.

## Soldering Guidelines

To implement and control the production of surface-mount assemblies, the dynamics of the solder reflow process and how each element of the process is related to the end result must be thoroughly understood.

**Note:** Xilinx recommends that customers qualify their custom PCB assembly processes using package samples. [UG112: Device Package User Guide](#) contains further details on recommended assembly procedures.

The primary phases of the reflow process are:

1. Melting the particles in the solder paste
2. Wetting the surfaces to be joined
3. Solidifying the solder into a strong metallurgical bond

In a Pb-free soldering system, the sequences are the same. However, for the Pb-free soldering system, higher reflow temperature is applied. The peak reflow temperature of a plastic surface-mount component (PSMC) body should not be more than 220°C for standard packages and 245–260°C for Pb-free packages (package size dependent). For multiple BGAs in a single board and because of surrounding component differences, Xilinx recommends checking all BGA sites for varying temperatures.

The infrared reflow (IR) process is strongly dependent on equipment and loading. Components might overheat due to lack of thermal constraints. Unbalanced loading can lead to significant temperature variation on the board. These guidelines are intended to assist users in avoiding damage to the components; the actual profile should be determined by those using these guidelines. For complete information on package moisture / reflow classification and package reflow conditions, refer to the Joint IPC/ JEDEC Standard J-STD-020C.

### Sn/Pb Reflow Soldering

[Figure 5-6](#) shows typical conditions for solder reflow processing of Sn/Pb soldering using IR/convection. Both IR and convection furnaces are used for BGA assembly. The moisture sensitivity of PSMCs must be verified prior to surface-mount flow.

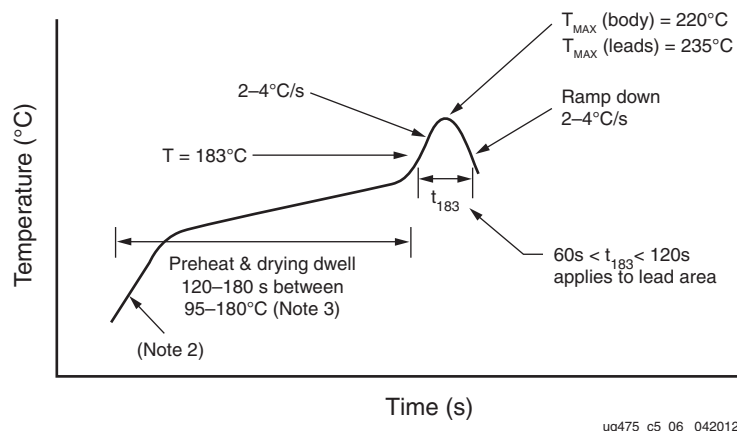

Figure 5-6: Typical Conditions for IR Reflow Soldering of Sn/Pb Solder

Notes for [Figure 5-6](#):

1. Maximum temperature range = 220°C (body). Minimum temperature range before 205°C (leads/balls).
2. Preheat drying transition rate 2–4°C/s
3. Preheat dwell 95–180°C for 120–180 seconds
4. IR reflow must be performed on dry packages

## Pb-Free Reflow Soldering

Xilinx uses SnAgCu (SAC305) solder balls for BGA packages. In addition, suitable material are qualified for the higher reflow temperatures (245°C–250°C) required by Pb-free soldering processes. Xilinx recommends soldering SAC305 BGA packages with SAC305 solder paste.

The optimal profile must take into account the solder paste/flux used, the size of the board, the density of the components on the board, and the mix between large components and smaller, lighter components. Profiles should be established for all new board designs using thermocouples at multiple locations on the component. In addition, if there is a mixture of devices on the board, then the profile should be checked at various locations on the board. Ensure that the minimum reflow temperature is reached to reflow the larger components and at the same time, the temperature does not exceed the threshold temperature that might damage the smaller, heat sensitive components.

[Table 5-3](#) and [Figure 5-7](#) provide guidelines for profiling Pb-free solder reflow.

In general, a gradual, linear ramp into a spike has been shown by various sources to be the optimal reflow profile for Pb-free solders ([Figure 5-7](#)). SAC305 alloy reaches full liquidus temperature at 235°C. When profiling, identify the possible locations of the coldest solder joints and ensure that those solder joints reach a minimum peak temperature of 235°C for at least 10 seconds. It might not be necessary to ramp to peak temperatures of 260°C. Reflowing at high peak temperatures of 260°C and above can damage the heat sensitive components and cause the board to warp.

Users should reference the latest IPC/JEDEC J-STD-020 standard for the allowable peak temperature on the component body. The allowable peak temperature on the component body is dependent on the size of the component. Refer to [Table 5-3](#) for peak package reflow body temperature information. In any case, use a reflow profile with the lowest peak temperature possible.

**Table 5-3: Pb-Free Reflow Soldering Guidelines**

Profile Feature	Convection, IR/Convection
Ramp-up rate	3°C/s maximum
Preheat Temperature 150°–200°C	60–120 seconds
Temperature maintained above 217°C	60–150 seconds (60–90 seconds typical)
Time within 5°C of actual peak temperature	30 seconds maximum
Peak Temperature (lead/ball)	235°C minimum, 245°C typical (depends on solder paste, board size, components mixture)
Peak Temperature (body)	245°C–260°C, package body size dependent (reference <a href="#">Table 5-4</a> )

Table 5-3: Pb-Free Reflow Soldering Guidelines (Cont'd)

Profile Feature	Convection, IR/Convection
Ramp-down Rate	6°C/s maximum
Time 25°C to Peak Temperature	3.5 minutes minimum, 5.0 minutes typical, 8 minutes maximum

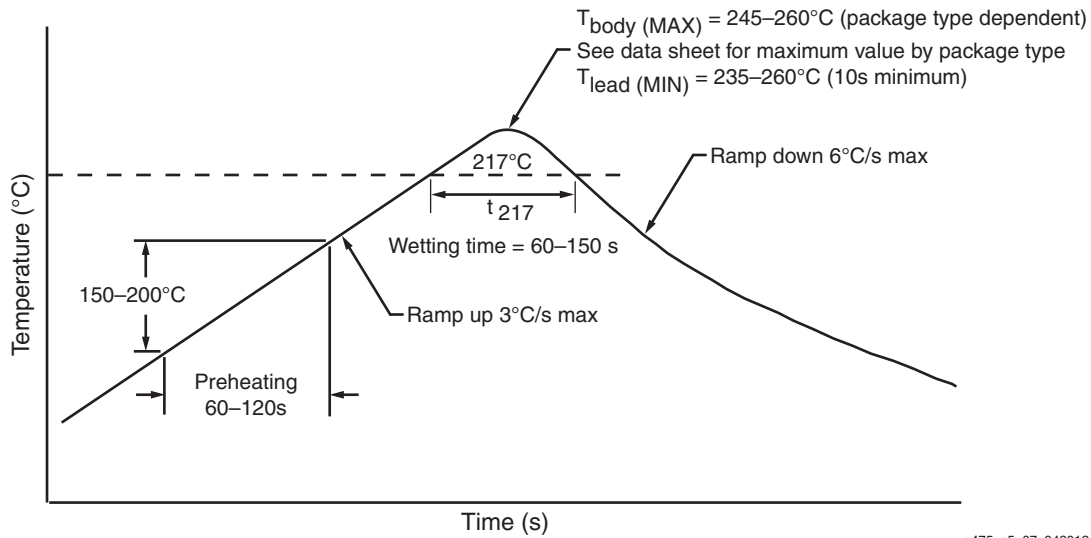

Figure 5-7: Typical Conditions for Pb-Free Reflow Soldering



**Table 5-4: Peak Package Reflow Body Temperature for Xilinx Pb-Free Packages (Based on J-STD-020 Standard)**

Package	Peak Package Reflow Body Temperature	JEDEC Moisture Sensitivity Level (MSL)
<b>BGA</b>		
Flip-Chip	FLG1925 FLG1926 FLG1928 FLG1930 FHG1761	Note 1 4
	SBG484 FBG484 FBG676 FBG900 FFG676 FFG900 FFG901 FFG1156 FFG1157 FFG1158 FFG1761 FFG1926 FFG1927 FFG1928 FFG1930	Note 1 4
	RF676 RF900 RF1157 RF1761 RF1930	Note 1 4
Wire Bond	CLG225 CLG400 CLG484 CSG324 FTG256 FGG484 FGG676	Note 1 3

**Notes:**

1. See specific 7 series device data sheets at: [http://www.xilinx.com/support/documentation/7\\_series.htm#156339](http://www.xilinx.com/support/documentation/7_series.htm#156339)

For sophisticated boards with a substantial mix of large and small components, it is critical to minimize the  $\Delta T$  across the board ( $<10^{\circ}\text{C}$ ) to minimize board warpage and thus, attain higher assembly yields. Minimizing the  $\Delta T$  is accomplished by using a slower rate in the warm-up and preheating stages. Xilinx recommends a heating rate of less than  $1^{\circ}\text{C}/\text{s}$  during the preheating and soaking stages, in combination with a heating rate of not more than  $3^{\circ}\text{C}/\text{s}$  throughout the rest of the profile.

It is also important to minimize the temperature gradient on the component, between top surface and bottom side, especially during the cooling down phase. The key is to optimize cooling while maintaining a minimal temperature differential between the top surface of the package and the solder joint area. The temperature differential between the top surface of the component and the solder balls should be maintained at less than  $7^{\circ}\text{C}$  during the critical region of the cooling phase of the reflow process. This critical region is in the part of the cooling phase where the balls are not completely solidified to the board yet, usually between the  $200^{\circ}\text{C}$ – $217^{\circ}\text{C}$  range. To efficiently cool the parts, divide the cooling section into multiple zones, with each zone operating at different temperatures.

For more information on Xilinx Pb-free solutions, refer to:

[http://www.xilinx.com/system\\_resources/lead\\_free/index.htm](http://www.xilinx.com/system_resources/lead_free/index.htm).

For more information on the Pb-free reflow process, refer to [XAPP427: Implementation and Solder Reflow Guidelines for Pb-Free Packages](#).

## References

The following websites contain additional information on heat management and contact information.

- <http://www.wakefield.com>
- <http://www.aavidthermalloy.com>
- <http://www.qats.com>

Refer to the following websites for interface material sources:

- Power Devices - <http://www.powerdevices.com>
- Bergquist Company - <http://www.bergquistcompany.com>
- AOS Thermal Compound - <http://www.aosco.com>
- Chometrics - <http://www.chometrics.com>
- Kester - <http://www.kester.com>

Refer to the following websites for CFD tools Xilinx supports with thermal models.

- Flomerics - Flotherm & FloPCB - <http://www.flomerics.com>
- Fluent - Icepak - <http://www.icepak.com>

# Package Marking

All 7 series devices have package top-markings similar to the examples shown in [Figure 6-1](#), [Figure 6-2](#), and [Figure 6-3](#). The markings are explained in [Table 6-1](#).

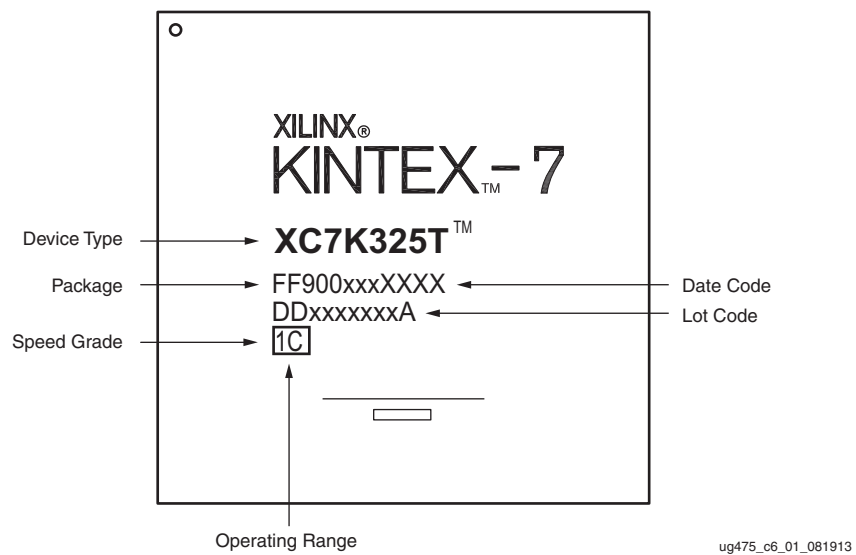

Figure 6-1: Kintex-7 Device Package Marking

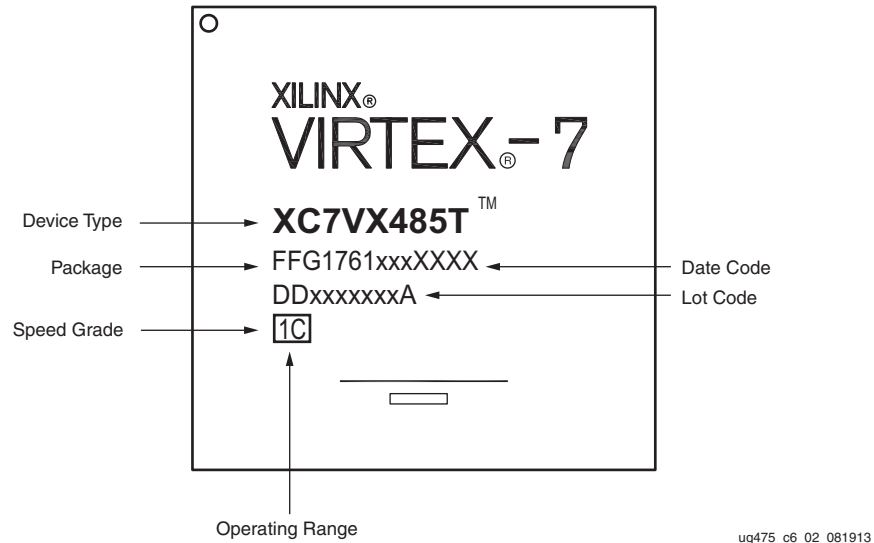

Figure 6-2: Virtex-7 Device Package Marking

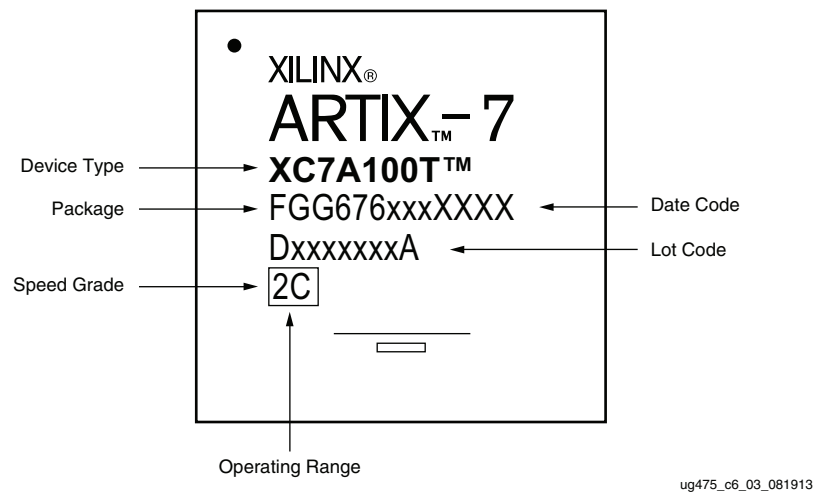

Figure 6-3: Artix-7 Device Package Marking

Table 6-1: Xilinx Device Marking Definition—Example

Item	Definition
Xilinx Logo	Xilinx logo, Xilinx name with trademark, and trademark-registered status.
Family Brand Logo	Device family name with trademark and trademark-registered status. This line is optional and could appear blank.
1st Line	Device type.
2nd Line	Package code, circuit design revision, the location code for the wafer fab, the geometry code, and date code. A G in the third letter of a package code indicates a Pb-free RoHS compliant package. For more details on Xilinx Pb-Free and RoHS Compliant Products, see: <a href="http://www.xilinx.com/pbfree">http://www.xilinx.com/pbfree</a> .

**Table 6-1: Xilinx Device Marking Definition—Example (Cont'd)**

Item	Definition	
3rd Line	Ten alphanumeric characters for Assembly, Lot, and Step information. The last digit is usually an <i>A</i> or an <i>M</i> if a stepping version does not exist.	
4th Line	Device speed grade and temperature range. When not marked on the package, the product is considered to operate at the commercial (C) temperature range. For more information on the ordering codes, see <a href="#">DS180: 7 Series FPGAs Overview</a> . Other variations for the 4th line:	
	L2E	The <i>L2E</i> indicates a -2LE device. The -2LE speed grade offers reduced maximum power consumption. Artix-7 and Kintex-7 FPGAs are capable of operating at lower core voltage. The E is for the extended temperature operating range. For more information, see the specific device's data sheet at: <a href="http://www.xilinx.com/support/documentation/7_series.htm#156339">http://www.xilinx.com/support/documentation/7_series.htm#156339</a> .
	1C xxxx	The <i>xxxx</i> indicates the SCD for the device. An SCD is a special ordering code that is not always marked in the device top mark.
	1C ES	The addition of an <i>ES</i> indicates an Engineering Sample.



# Recommended PCB Design Rules for BGA Packages

Xilinx provides the diameter of a land pad on the package side. This information is required prior to the start of the board layout so the board pads can be designed to match the component-side land geometry. The typical values of these land pads are described in [Figure A-1](#) and summarized in [Table A-1](#) for both 0.8 mm and 1.0 mm pitch packages. For Xilinx BGA packages, non-solder mask defined (NSMD) pads on the board are suggested to allow a clearance between the land metal (diameter L) and the solder mask opening (diameter M) as shown in [Figure A-1](#). An example of an NSMD PCB pad solder joint is shown in [Figure A-2](#). It is recommended to have the board land pad diameter with a 1:1 ratio to the package solder mask defined (SMD) pad for improved board level reliability.

The space between the NSMD pad and the solder mask as well as the actual signal trace widths and via dimensions depend on the capability of the PCB vendor. The cost of the PCB is higher when the line width and spaces are smaller.

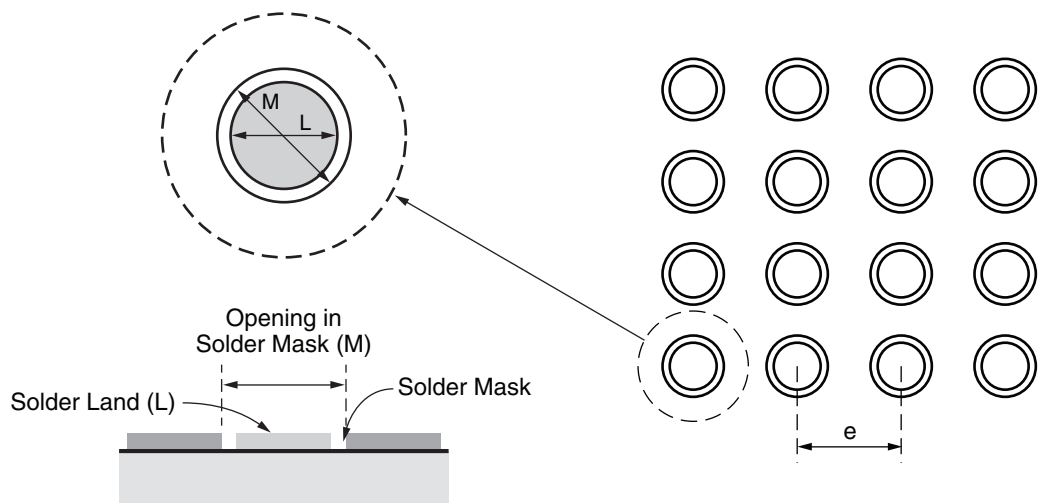

UG475\_aA\_01\_092313

Figure A-1: Suggested Board Layout of Soldered Pads for BGA Packages

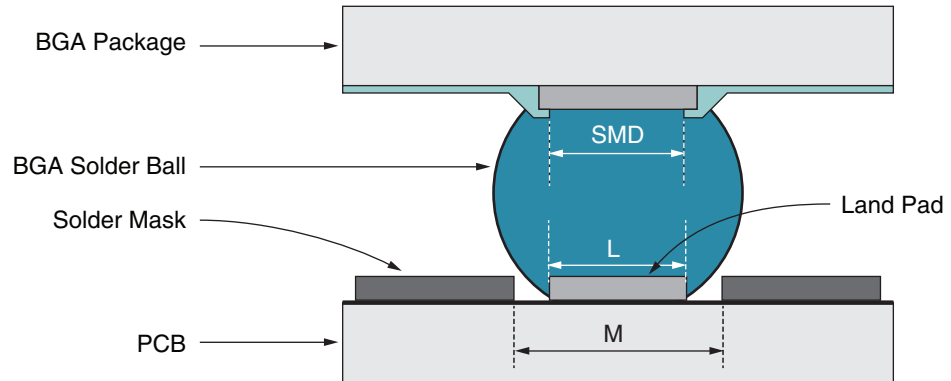

UG475\_aA\_02\_110513

Figure A-2: Example of an NSMD PCB Pad Solder Joint

Table A-1: BGA Package Design Rules

Packages	0.8 mm Pitch	1.0 mm Pitch		
	SB/SBG, CS/CSG, CL/CLG	FF/FFG, FB/FBG, FH/FHG, FL/FLG, RF/RB/RS	FG/FGG	FT/FTG
Design Rule	Dimensions in mm (mils)			
Package land pad opening (SMD)	0.40 mm (15.7 mils)	0.53 mm (20.9 mils)	0.50 mm (19.7 mils)	0.40 mm (15.7 mils)
Maximum PCB solder land (L) diameter	0.40 mm (15.7 mils)	0.53 mm (20.9 mils)	0.50 mm (19.7 mils)	0.40 mm (15.7 mils)
Opening in PCB solder mask (M) diameter	0.50 mm (19.7 mils)	0.63 mm (24.8 mils)	0.60 mm (23.6 mils)	0.50 mm (19.7 mils)
Solder ball land pitch (e)	0.80 mm (31.5 mils)	1.00 mm (39.4 mils)	1.00 mm (39.4 mils)	1.00 mm (39.4 mils)

**Notes:**

1. Controlling dimension in mm.



# Heat Sink Guidelines for Lidless Flip-Chip Packages

## Heat Sink Attachments for Lidless FCBGA (FB/FBG)

Heat sinks can be attached to the package in multiple ways. For heat to dissipate effectively, the advantages and disadvantages of each heat sink attachment method must be considered. Factors influencing the selection of the heat sink attachment method include the package type, contact area of the heat source, and the heat sink type.

### Silicon and Decoupling Capacitors Height Consideration

When designing heat sink attachments for lidless flip-chip BGA (FCBGA) packages, the height of the die above the substrate and also the height of decoupling capacitors must be considered (Figure B-1). This is to prevent electrical shorting between the heat sink (metal) and the decoupling capacitors.

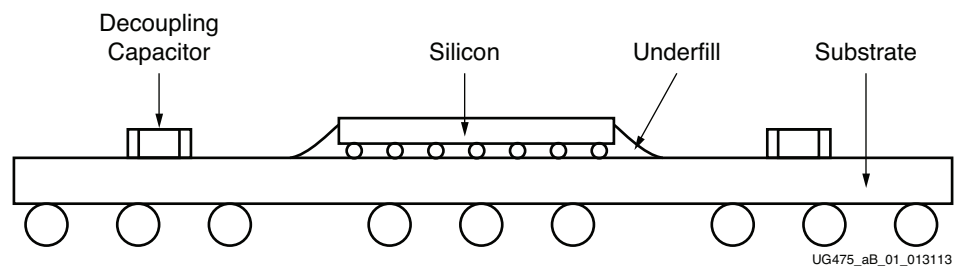

Figure B-1: Cross Section of Lidless Flip-chip BGA

## Types of Heat Sink Attachments

There are six main methods for heat sink attachment. Table B-1 lists their advantages and disadvantages.

- Thermal tape
- Thermally conductive adhesive or glue (epoxy)
- Wire form Z-clips
- Plastic clip-ons
- Threaded stand-offs (PEMs) and compression springs
- Push-pins and compression springs

Table B-1: Heat Sink Attachment Methods

Attachment Method	Advantages	Disadvantages
Thermal tape	<ul style="list-style-type: none"> <li>• Generally easy to attach and is inexpensive.</li> <li>• Lowest cost approach for aluminum heat sink attachment.</li> <li>• No additional space required on the PCB.</li> </ul>	<ul style="list-style-type: none"> <li>• The surfaces of the heat sink and the chip must be very clean to allow the tape to bond correctly.</li> <li>• Because of the small contact area, the tape might not provide sufficient bond strength.</li> <li>• Tape is a moderate to low thermal conductor that could affect the thermal performance.</li> </ul>
Thermally conductive adhesive or glue	<ul style="list-style-type: none"> <li>• Outstanding mechanical adhesion.</li> <li>• Fairly inexpensive, costs a little more than tape.</li> <li>• No additional space required on the PCB.</li> </ul>	<ul style="list-style-type: none"> <li>• Adhesive application process is challenging and it is difficult to control the amount of adhesive to use.</li> <li>• Difficult to rework.</li> <li>• Because of the small contact area, the adhesive might not provide sufficient bond strength.</li> </ul>
Wire form Z-clips	<ul style="list-style-type: none"> <li>• It provides a strong and secure mechanical attachment. In environments that require shock and vibration testing, this type of strong mechanical attachment is necessary.</li> <li>• Easy to apply and remove. Does not cause the semiconductors to be destroyed (epoxy and occasionally tape can destroy the device).</li> <li>• It applies a preload onto the thermal interface material (TIM). Pre-loads actually improve thermal performance.</li> </ul>	<ul style="list-style-type: none"> <li>• Requires additional space on the PCB for anchor locations.</li> </ul>
Plastic clip-ons	<ul style="list-style-type: none"> <li>• Suitable for designs where space on the PCB is limited.</li> <li>• Easy to rework by allowing heat sinks to be easily removed and reapplied without damaging the PCB board.</li> <li>• Can provide a strong enough mechanical attachment to pass shock and vibration test.</li> </ul>	<ul style="list-style-type: none"> <li>• Needs a keep out area around the silicon devices to use the clip.</li> <li>• Caution is required when installing or removing clip-ons because localized stress can damage the solder balls or chip substrate.</li> </ul>
Threaded stand-offs (PEMs) and compression springs	<ul style="list-style-type: none"> <li>• Provides stable attachments to heat source and transfers load to the PCB, backing plate, or chassis.</li> <li>• Suitable for high mass heat sinks.</li> <li>• Allows for tight control over mounting force and load placed on chip and solder balls.</li> </ul>	<ul style="list-style-type: none"> <li>• Holes are required in the PCB taking valuable space that can be used for trace lines.</li> <li>• Tends to be expensive, especially since holes need to be drilled or predrilled onto the PCB board to use stand-offs.</li> </ul>
Push-pins and compression springs	<ul style="list-style-type: none"> <li>• Provides a stable attachment to a heat source and transfers load to the PCB.</li> <li>• Allows for tight control over mounting force and load placed on chip and solder balls.</li> </ul>	<ul style="list-style-type: none"> <li>• Requires additional space on the PCB for push-pin locations.</li> </ul>

## Heat Sink Attachment

### Component Pick-up Tool Consideration

For pick-and-place machines to place lidless FCBGAs onto PCBs, Xilinx recommends using soft tips or suction cups for the nozzles. This prevents chipping, scratching, or even cracking of the bare die (Figure B-2).

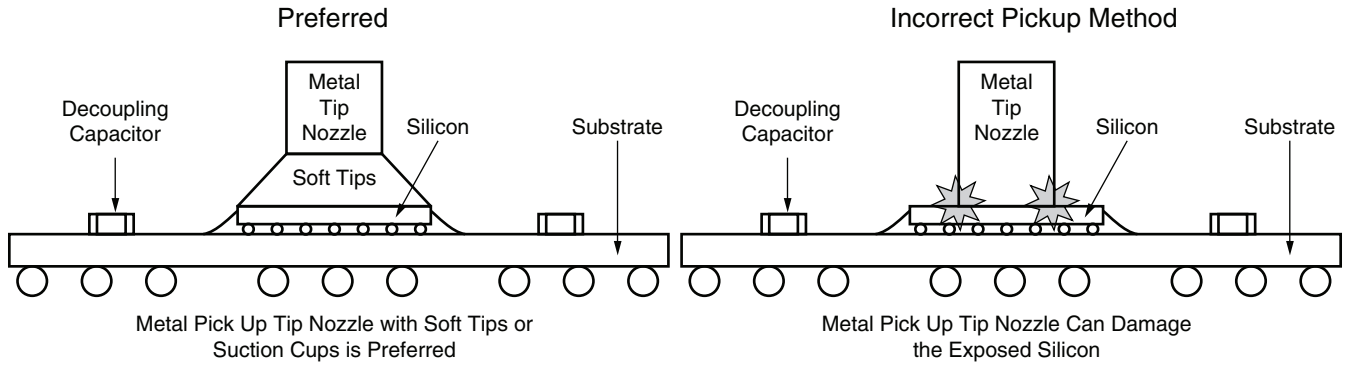

UG475\_aB\_02\_013113

Figure B-2: Recommended Method For Using Pick-up Tools

### Heat Sink Attachment Process Considerations

After the component is placed onto the PCBs, when attaching a heat sink to the lidless package, the factors in Table B-2 must be carefully considered (see Figure B-3).

Table B-2: Heat Sink Attachment Considerations

Consideration(s)	Effect(s)	Recommendation(s)
In heat sink attach process, what factors can cause damage to the expose die and passive capacitors?	<ul style="list-style-type: none"> <li>• Uneven heat sink placement</li> <li>• Uneven TIM thickness</li> <li>• Uneven force applied when placing heat sink placement</li> </ul>	<ul style="list-style-type: none"> <li>• Even heat sink placement</li> <li>• Even TIM thickness</li> <li>• Even force applied when placing heat sink placement</li> </ul>
Does the heat sink tilt or tip the post attachment?	Uneven heat sink placement will damage the silicon and can cause field failures.	<ul style="list-style-type: none"> <li>• Careful handling not to contact the heat sink with the post attachment.</li> <li>• Use a fixture to hold the heat sink in place with post attachment until it is glued to the silicon.</li> </ul>

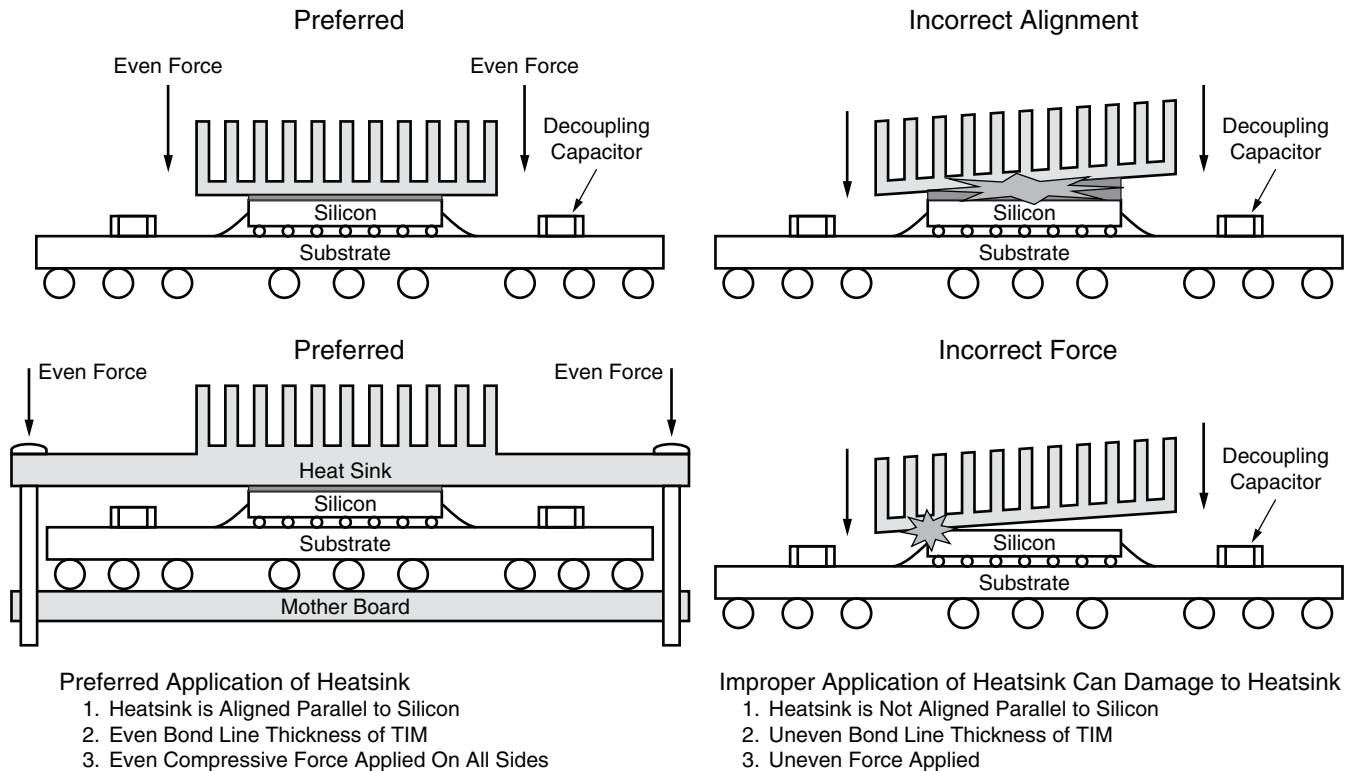

UG475\_aB\_03\_013113

**Figure B-3: Recommended Application of Heat Sink**

### Standard Heat Sink Attach Process with Thermal Conductive Adhesive

Prior to attaching the heat sink, the FPGA needs be surface mounted on the motherboard.

1. Place the motherboard into a jig or a fixture to hold the motherboard steady to prevent any movement during the heat sink attachment process.
2. Thermoset material (electrically non-conductive) is applied over the backside surface of silicon in a pattern using automated dispensing equipment. Automated dispensers are often used to provide a stable process speed at a relatively low cost. The optimum dispensing pattern needs to be determined by the SMT supplier.

**Note:** Minimal volume coverage of the backside of the silicon can result in non-optimum heat transfer.

3. The heat sink is placed on the backside of the silicon with a pick and place machine. A uniform pressure is applied over the heat sink to the backside of the silicon. As the heat sink is placed, the adhesive spreads to cover the backside silicon. A force transducer is normally used to measure and limit the placement force.
4. The epoxy is cured with heat at a defined time.

**Note:** The epoxy curing temperature and time is based on manufacturer's specifications.

### Standard Heat Sink Attach Process with Thermal Adhesive Tape

Prior to attaching the heat sink, the FPGA needs be surface mounted on the motherboard.

1. Place the motherboard into a jig or a fixture to hold the motherboard steady to prevent any movement during the heat sink attachment process.
2. Thermal adhesive tape cut to the size of the heat sink is applied on the underside of the heat sink at a modest angle with the use of a squeegee rubber roller. Apply pressure to help reduce the possibility of air entrapment under the tape during application.
3. The heat sink is placed on the backside of the silicon with a pick and place machine. A uniform pressure is applied over the heat sink to the backside of the silicon. As the heat sink is placed, the thermal adhesive tape is glued to the backside of the silicon. A force transducer is normally used to measure and limit the placement force.
4. A uniform and constant pressure is applied uniformly over the heat sink and held for a defined time.

**Note:** The thermal adhesive tape hold time is based on manufacturer's specifications.

### Push-Pin and Shoulder Screw Heat Sink Attachment Process with Phase Change Material (PCM) Application

Prior to attaching the heat sink, the FPGA needs be surface mounted on the motherboard.

1. Place the motherboard into a jig or a fixture to hold the motherboard steady to prevent any movement during the heat sink attachment process.

**Note:** The jig or fixture needs to account for the push pin depth of the heat sink.

2. PCM tape, cut to the size of the heat sink, os applied on the underside of the heat sink at a modest angle with the use of a squeegee rubber roller. Apply pressure to help reduce the possibility of air entrapment under the tape during application.
3. Using the push-pin tool, heat sinks are applied over the packages ensuring a pin locking action with the PCB holes. The compression load from springs applies the appropriate mounting pressure required for proper thermal interface material performance.

**Note:** Heat sinks must not tilt during installation. This process cannot be automated due to the mechanical locking action which requires manual handling. The PCB drill hole tolerances need to be close enough to eliminate any issues concerning the heat sink attachment.

## Package Loading Specifications

For lidless FCBGA, Xilinx specifies a maximum static load of 60 psi. This mechanical maximum load limit cannot be exceeded during heat sink assembly, shipping conditions, or standard use conditions. Any mechanical system or component testing must not exceed the maximum limit.

The static load of maximum 60 psi is:

- Applied as uniform compressive loading in a direction normal to the package.
- The maximum allowed load from the heat sink retention clip.
- Based on limited testing for design characterization. Loading limits are for the package only.

**Note:** As a precaution; a minimum point force of 75 ft-lbs can cause the die to crack.

For thermal and mechanical solutions, the package substrate must not be used as a mechanical reference or load-bearing surface. For heat sink clip pre-load calculations, the post-reflow package height must be used.

## Reasons for Thermal Interface Material

When installing heat sinks for Xilinx FPGAs, a suitable thermal interface material (TIM) must be used. This thermal material significantly aids the transfer of heat from the component to the heat sink. For optimum heat transfer, Xilinx recommends the use of thermal interface materials.

For lidless FCBGAs, the surface of the silicon contacts the heat sink. For lidded FCBGAs, the lid contacts the heat sink. The surface size of the lidless FCBGA and lidded FCBGA are different. Xilinx recommends a different type of thermal material for long-term use with each type of FCBGA package.

Thermal interface material is needed because even the largest heat sink and fan cannot effectively cool an FPGA unless there is good physical contact between the base of the heat sink and the top of the FPGA. The surfaces of both the heat sink and the FPGA silicon are not absolutely smooth. This surface roughness is observed when examined at a microscopic level. Because surface roughness reduces the effective contact area, attaching a heat sink without a thermal interface material is not sufficient due to inadequate surface contact.

A thermal interface material such as phase-change material, thermal grease, or thermal pads fills these gaps and allows effective transference of heat between the FPGA die and the heat sink.

## Types of TIM

There are many type of TIM available for sale. The most commonly used thermal interface materials are:

- Thermal pads, also called phase-change materials.
- Thermal grease, also called thermal paste.

Phase-change materials are usually thin pads approximately 1 inch x 1 inch (2.5 cm x 2.5 cm) in size and have protective films attached on both surfaces. The color is vendor-specific but is usually gray or pink. Thermal grease usually comes in a syringe, a tube, or a small plastic sachet. Thermal grease is similar in consistency to ordinary toothpaste and is typically gray or white.

## Guidelines for Thermal Interface Materials

Five factors affect the choice, use, and performance of the interface material used between the processor and the heat sink:

- [Thermal Conductivity of the Material](#)
- [Electrical Conductivity of the Material](#)
- [Spreading Characteristics of the Material](#)
- [Long-Term Stability and Reliability of the Material](#)
- [Ease of Application](#)

## Thermal Conductivity of the Material

Thermal conductivity is the quantified ability of any material to transfer heat. The thermal conductivity of the interface material has a significant impact on its thermal performance. The higher the thermal conductivity, the more efficient the material is at transferring heat. Materials that have a lower thermal conductivity are less efficient at transferring heat,

causing a higher temperature differential to exist across the interface. To overcome this less efficient heat transfer, a better cooling solution (typically, a more costly solution) must be used to achieve the desired heat dissipation.

## Electrical Conductivity of the Material

Some metal-based TIM compounds are electrically conductive. Ceramic-based compounds are typically not electrically conductive. Manufacturers produce metal-based compounds with low-electrical conductivity, but some of these materials are not completely electrically inert. Metal-based thermal compounds are not hazardous to the FPGA die itself, but other elements on the FPGA or motherboard can be at risk if they become contaminated by the compound. For this reason, Xilinx does not recommend the use of electrically conductive thermal interface material.

## Spreading Characteristics of the Material

The spreading characteristics of the thermal interface material determines its ability, under the pressure of the mounted heat sink, to spread and fill in or eliminate the air gaps between the FPGA and the heat sink. Because air is a very poor thermal conductor, the more completely the interface material fills the gaps, the greater the heat transference.

## Long-Term Stability and Reliability of the Material

The long-term stability and reliability of the thermal interface material is described as the ability to provide a sufficient thermal conductance even after an extended time or extensive. Low-quality compounds can harden or leak out over time (the pump-out effect), leading to overheating or premature failure of the FPGA. High-quality compounds provide a stable and reliable thermal interface material throughout the lifetime of the device. Thermal greases with higher viscosities are typically more resistant to pump out effects on lidless devices.

## Ease of Application

A spreadable thermal grease requires the surface mount supplier to carefully use the appropriate amount of material. Too much or too little material can cause problems. The thermal pad is a fixed size and is therefore easier to apply in a consistent manner.

## Comparing the Types of Interface Materials

### Thermal Grease

Thermal grease is a paste made up of thermally conductive ceramic fillers in silicone or hydrocarbon oils. It is applied to one of the two mating surfaces. When the surfaces are pressed together, the grease spreads to fill the void. See [Table B-3](#) for the thermal resistance, and pros and cons of usage.

Table B-3: Thermal Grease

Thermal Resistance	Pros	Cons
0.2 to 1°C cm <sup>2</sup> /W	<ul style="list-style-type: none"> <li>Eliminates air gaps between components and the heat sink.</li> <li>Compensates for uneven heat sink surface and silicon.</li> <li>It is soft and is easy to compress to the height differential of multiple components.</li> <li>Stress-free with outstanding mechanical shock absorption.</li> </ul>	<ul style="list-style-type: none"> <li>Hard to use in manufacturing because it is difficult to dispense and apply due to a high viscosity.</li> <li>Requires cleanup to prevent contamination problems.</li> <li>Requires mechanical clamping to hold the heat sink and component in its place.</li> <li>Applications with repeated power on/off cycles might cause occurrence of pump-out, where the grease is forced from between the silicon die and the heat sink each time the die is heated up and cooled down. This can cause thermal performance degradation over time and contaminate the neighboring components.</li> </ul>

### Thermal Gel

Thermal gels are dispensed like thermal grease. They are cured to a partially cross-linked structure, which eliminates the pump-out issue. See [Table B-4](#) for the thermal resistance, and pros and cons of usage.

Table B-4: Thermal Gel

Thermal Resistance	Pros	Cons
0.15 to 1°C cm <sup>2</sup> /W	<ul style="list-style-type: none"> <li>No pump out issues.</li> <li>Eliminates air gaps between components and the heat sink.</li> <li>Compensates for uneven heat sink surface and silicon.</li> <li>It is soft and is easy to compress to the height differential of multiple components.</li> <li>Stress-free with outstanding mechanical shock absorption.</li> </ul>	<ul style="list-style-type: none"> <li>A mechanical fastener is essential to maintain the joint once it is assembled.</li> </ul>

### Thermal Conductive Compound

A thermally conductive compound incorporates thermally conductive fillers. However, unlike thermal greases, the binder is a rubber material. When first applied, the paste-like compound flows into the interstices between the mating surfaces. Then, when subjected to heat, it cures into a dry rubber film. Besides its thermal properties, this film also serves as an adhesive, allowing a tight, void-free joint without the need for additional fasteners. Thermally conductive compounds can successfully fill larger gaps in situations where thermal greases might ooze from the joint. Although application and performance is similar to that of thermal grease, cleanup is easier, simply involving removal of the excess cured rubber film. See [Table B-5](#) for the thermal resistance, and pros and cons of usage.



Table B-5: Thermal Conductive Compound

Thermal Resistance	Pros	Cons
0.15 to 1°C cm <sup>2</sup> /W	<ul style="list-style-type: none"> <li>Mechanical clamping not required.</li> </ul>	<ul style="list-style-type: none"> <li>Cannot be reworked.</li> <li>Metal-based conductive adhesives can cause electrical shorting with contamination on the FPGAs and other devices on the motherboard.</li> </ul>

### Thermally Conductive Elastomeric Pads

Thermally conductive elastomeric pads consist of a silicone elastomer filled with thermally conductive ceramic particles and can incorporate woven glass fiber or dielectric film reinforcement. Typically, the recommended thickness is from 0.1 mm to 1 mm. The recommended hardness rating is from 5 to 85 Shore A. By providing both electrical insulation and thermal conductivity, they are useful in applications requiring electrical isolation. Thicker pads are used when large gaps must be filled. During application, the pads are compressed between the mating surfaces to make them conform to surface irregularities. See Table B-6 for the thermal resistance, and pros and cons of usage.

Table B-6: Thermally Conductive Elastomeric Pads

Thermal Resistance	Pros	Cons
1 to 3°C cm <sup>2</sup> /W	<ul style="list-style-type: none"> <li>Simple assembly.</li> </ul>	<ul style="list-style-type: none"> <li>A mechanical fastener is essential to maintain the joint once it is assembled.</li> <li>Mounting pressure must be adjusted according to the hardness of the elastomer to ensure that voids are filled.</li> </ul>

### Thermal Tapes

A thermal tape is a double-sided pressure sensitive adhesive film filled with thermally conductive ceramic powder. To facilitate handling, aluminum foil or a polyimide film can be used to support the tape; the latter material also provides electrical insulation. When applied between mating surfaces, the tape must be subjected to pressure to conform to the surfaces. Once the joint is made, the adhesive holds it together permanently, eliminating the need for supplemental fasteners. No bond curing is needed. See Table B-7 for the thermal resistance, and pros and cons of usage.

Table B-7: Thermal Tapes

Thermal Resistance	Pros	Cons
1 to 4°C cm <sup>2</sup> /W	<ul style="list-style-type: none"> <li>Simple assembly.</li> <li>Mechanical clamping not required.</li> </ul>	<ul style="list-style-type: none"> <li>Cannot fill large gaps between mating surfaces as well as liquids, which can affect thermal performance.</li> </ul>

### Phase Change Materials

Solid at room temperature, phase change materials are melted (i.e., undergo a phase change) as the temperature rises to the 104°F to 158°F (40°C to 70°C) range. This makes the material (0.13 mm thick in its dry film form) as easy to handle as a pad, while assuring that it will, when subjected to heat during the assembly process, flow into voids between

mating surfaces as effectively as a thermal grease. Ordinarily, applying power to the electronic component introduces the needed heat for the phase change to occur, establishing a stable thermal joint. These materials consist of organic binders (i.e., a polymer and a low-melt-point crystalline component, such as a wax), thermally conductive ceramic fillers, and, if necessary, a supporting substrate, such as aluminum foil or woven glass mesh. See [Table B-7](#) for the thermal resistance, and pros and cons of usage.

Table B-8: Phase Change Materials

Thermal Resistance	Pros	Cons
0.3 to 0.7°C cm <sup>2</sup> /W	<ul style="list-style-type: none"> <li>• Simple assembly.</li> <li>• Mechanical clamping not required.</li> </ul>	<ul style="list-style-type: none"> <li>• Cannot be reworked.</li> <li>• A mechanical fastener is essential to maintain the joint once it is assembled.</li> </ul>

## Thermal Material Handling Guidelines

When not familiar with installing the heat sink on an FPGA, the assistance of a professional system builder, such as Sanmina (<http://www.sanmina.com/>) is warranted. Incorrect handling or assembling of FPGA components can damage parts, void the warranty, and lead to disappointing results.

If a chosen heat sink does not include the thermal interface material, inexperienced users should request recommendations from Xilinx.

Before applying any interface material, always make sure that the surfaces are clean and free of foreign materials. If the surface of the heat sink or FPGA becomes soiled or greasy, use a lint-free wipe or cloth and a mild solvent such as denatured alcohol to clean it.

Never reuse a thermal interface material. To reuse a heat sink, remove any residue of the previously used thermal material with a nonmetallic object like a plastic spatula and then use a lint-free wipe or cloth and a mild solvent such as denatured alcohol to fully cleanse the surface. Reapply a new thermal interface material.