

# Spartan-3 Libraries Guide for Schematic Designs

ISE 10.1

## Xilinx Trademarks and Copyright Information



Xilinx is disclosing this user guide, manual, release note, and/or specification (the “Documentation”) to you solely for use in the development of designs to operate with Xilinx hardware devices. You may not reproduce, distribute, republish, download, display, post, or transmit the Documentation in any form or by any means including, but not limited to, electronic, mechanical, photocopying, recording, or otherwise, without the prior written consent of Xilinx. Xilinx expressly disclaims any liability arising out of your use of the Documentation. Xilinx reserves the right, at its sole discretion, to change the Documentation without notice at any time. Xilinx assumes no obligation to correct any errors contained in the Documentation, or to advise you of any corrections or updates. Xilinx expressly disclaims any liability in connection with technical support or assistance that may be provided to you in connection with the Information.

THE DOCUMENTATION IS DISCLOSED TO YOU “AS-IS” WITH NO WARRANTY OF ANY KIND. XILINX MAKES NO OTHER WARRANTIES, WHETHER EXPRESS, IMPLIED, OR STATUTORY, REGARDING THE DOCUMENTATION, INCLUDING ANY WARRANTIES OF MERCHANTABILITY, FITNESS FOR A PARTICULAR PURPOSE, OR NONINFRINGEMENT OF THIRD-PARTY RIGHTS. IN NO EVENT WILL XILINX BE LIABLE FOR ANY CONSEQUENTIAL, INDIRECT, EXEMPLARY, SPECIAL, OR INCIDENTAL DAMAGES, INCLUDING ANY LOSS OF DATA OR LOST PROFITS, ARISING FROM YOUR USE OF THE DOCUMENTATION.

© Copyright 2002 – 2008 Xilinx, Inc. All Rights Reserved. XILINX, the Xilinx logo, the Brand Window and other designated brands included herein are trademarks of Xilinx, Inc. All other trademarks are the property of their respective owners.

# Table of Contents

About this Guide.....	13
Functional Categories.....	15
About Design Elements.....	33
ACC16.....	34
ACC4.....	36
ACC8.....	38
ADD16.....	40
ADD4.....	42
ADD8.....	44
ADSU16.....	45
ADSU4.....	47
ADSU8.....	49
AND12.....	51
AND16.....	52
AND2.....	53
AND2B1.....	54
AND2B2.....	55
AND3.....	56
AND3B1.....	57
AND3B2.....	58
AND3B3.....	59
AND4.....	60
AND4B1.....	61
AND4B2.....	62
AND4B3.....	63
AND4B4.....	64
AND5.....	65
AND5B1.....	66
AND5B2.....	67
AND5B3.....	68
AND5B4.....	69
AND5B5.....	70
AND6.....	71
AND7.....	72
AND8.....	73
AND9.....	74
BRLSHFT4.....	75
BRLSHFT8.....	76
BSCAN_SPARTAN3.....	77
BUF.....	78
BUFCF.....	79
BUFG.....	80
BUFGCE.....	81
BUFGCE_1.....	82
BUFGMUX.....	83
BUFGMUX_1.....	84
BUFGP.....	85
CAPTURE_SPARTAN3.....	86
CB16CE.....	87
CB16CLE.....	88
CB16CLED.....	90
CB16RE.....	92
CB2CE.....	93
CB2CLE.....	94
CB2CLED.....	96
CB2RE.....	98

CB4CE .....	99
CB4CLE .....	100
CB4CLED .....	102
CB4RE .....	104
CB8CE .....	105
CB8CLE .....	106
CB8CLED .....	108
CB8RE .....	110
CC16CE .....	111
CC16CLE .....	112
CC16CLED .....	114
CC16RE .....	116
CC8CE .....	117
CC8CLE .....	118
CC8CLED .....	120
CC8RE .....	122
CD4CE .....	123
CD4CLE .....	125
CD4RE .....	127
CD4RLE .....	129
CJ4CE .....	131
CJ4RE .....	132
CJ5CE .....	133
CJ5RE .....	134
CJ8CE .....	135
CJ8RE .....	136
COMP16 .....	137
COMP2 .....	138
COMP4 .....	139
COMP8 .....	140
COMPM16 .....	141
COMPM2 .....	143
COMPM4 .....	144
COMPM8 .....	145
COMPMC16 .....	147
COMPMC8 .....	149
CR16CE .....	151
CR8CE .....	152
D2_4E .....	153
D3_8E .....	154
D4_16E .....	155
DCM .....	156
DEC_CC16 .....	159
DEC_CC4 .....	161
DEC_CC8 .....	162
DECODE16 .....	163
DECODE32 .....	164
DECODE4 .....	165
DECODE64 .....	166
DECODE8 .....	167
FD .....	168
FD_1 .....	169
FD16CE .....	170
FD16RE .....	171
FD4CE .....	172
FD4RE .....	173
FD8CE .....	174
FD8RE .....	175
FDC .....	176

FDC_1.....	177
FDCE.....	178
FDCE_1.....	179
FDCP.....	180
FDCP_1.....	181
FDCPE.....	182
FDCPE_1.....	184
FDDRCPE.....	186
FDDRRSE.....	187
FDE.....	188
FDE_1.....	189
FDP.....	190
FDP_1.....	191
FDPE.....	192
FDPE_1.....	193
FDR.....	194
FDR_1.....	195
FDRE.....	196
FDRE_1.....	197
FDRS.....	198
FDRS_1.....	199
FDRSE.....	200
FDRSE_1.....	201
FDS.....	202
FDS_1.....	203
FDSE.....	204
FDSE_1.....	205
FJKC.....	206
FJKCE.....	207
FJKP.....	208
FJKPE.....	209
FJKRSE.....	210
FJKSRE.....	211
FMAP.....	212
FTC.....	213
FTCE.....	214
FTCLE.....	215
FTCLEX.....	216
FTP.....	217
FTPE.....	218
FTPLE.....	219
FTRSE.....	220
FTRSLE.....	221
FTSRE.....	222
FTSRLE.....	223
GND.....	224
IBUF.....	225
IBUF16.....	227
IBUF4.....	228
IBUF8.....	229
IBUFDS.....	230
IBUFG.....	232
IBUFGDS.....	233
IFD.....	236
IFD_1.....	237
IFD16.....	238
IFD4.....	239
IFD8.....	240
IFDDRCPE.....	241

IFDDRSE .....	242
IFDI .....	244
IFDI_1 .....	245
IFDX .....	246
IFDX_1 .....	247
IFDX16 .....	248
IFDX4 .....	249
IFDX8 .....	250
IFDXI .....	251
IFDXI_1 .....	252
ILD .....	253
ILD_1 .....	254
ILD16 .....	255
ILD4 .....	256
ILD8 .....	257
ILDI .....	258
ILDI_1 .....	259
ILDx .....	260
ILDx_1 .....	261
ILDx16 .....	262
ILDx4 .....	263
ILDx8 .....	264
ILDxI .....	265
ILDxI_1 .....	266
INV .....	267
INV16 .....	268
INV4 .....	269
INV8 .....	270
IOBUF .....	271
IOBUFDS .....	273
KEEPER .....	275
LD .....	276
LD_1 .....	277
LD16 .....	278
LD16CE .....	279
LD4 .....	281
LD4CE .....	282
LD8 .....	284
LD8CE .....	285
LDC .....	286
LDC_1 .....	287
LDCE .....	288
LDCE_1 .....	289
LDCP .....	290
LDCP_1 .....	291
LDCPE .....	292
LDCPE_1 .....	294
LDE .....	296
LDE_1 .....	297
LDP .....	298
LDP_1 .....	299
LDPE .....	300
LDPE_1 .....	301
LUT1 .....	302
LUT1_D .....	304
LUT1_L .....	306
LUT2 .....	308
LUT2_D .....	310
LUT2_L .....	312

LUT3 .....	314
LUT3_D .....	315
LUT3_L .....	317
LUT4 .....	319
LUT4_D .....	321
LUT4_L .....	323
M16_1E .....	325
M2_1 .....	327
M2_1B1 .....	328
M2_1B2 .....	329
M2_1E .....	330
M4_1E .....	331
M8_1E .....	332
MULT_AND .....	333
MULT18X18 .....	334
MULT18X18S .....	335
MUXCY .....	336
MUXCY_D .....	337
MUXCY_L .....	338
MUXF5 .....	339
MUXF5_D .....	340
MUXF5_L .....	341
MUXF6 .....	342
MUXF6_D .....	343
MUXF6_L .....	344
MUXF7 .....	345
MUXF7_D .....	346
MUXF7_L .....	347
MUXF8 .....	348
MUXF8_D .....	349
MUXF8_L .....	350
NAND12 .....	351
NAND16 .....	352
NAND2 .....	353
NAND2B1 .....	354
NAND2B2 .....	355
NAND3 .....	356
NAND3B1 .....	357
NAND3B2 .....	358
NAND3B3 .....	359
NAND4 .....	360
NAND4B1 .....	361
NAND4B2 .....	362
NAND4B3 .....	363
NAND4B4 .....	364
NAND5 .....	365
NAND5B1 .....	366
NAND5B2 .....	367
NAND5B3 .....	368
NAND5B4 .....	369
NAND5B5 .....	370
NAND6 .....	371
NAND7 .....	372
NAND8 .....	373
NAND9 .....	374
NOR12 .....	375
NOR16 .....	376
NOR2 .....	377
NOR2B1 .....	378

NOR2B2.....	379
NOR3.....	380
NOR3B1.....	381
NOR3B2.....	382
NOR3B3.....	383
NOR4.....	384
NOR4B1.....	385
NOR4B2.....	386
NOR4B3.....	387
NOR4B4.....	388
NOR5.....	389
NOR5B1.....	390
NOR5B2.....	391
NOR5B3.....	392
NOR5B4.....	393
NOR5B5.....	394
NOR6.....	395
NOR7.....	396
NOR8.....	397
NOR9.....	398
OBUF.....	399
OBUF16.....	400
OBUF4.....	401
OBUF8.....	402
OBUFDS.....	403
OBUFT.....	404
OBUFTDS.....	406
OFD.....	407
OFD_1.....	408
OFD16.....	409
OFD4.....	410
OFD8.....	411
OFDDRCPE.....	412
OFDDRRSE.....	413
OFDDRTCPE.....	414
OFDDRTRSE.....	416
OFDE.....	418
OFDE_1.....	419
OFDE16.....	420
OFDE4.....	421
OFDE8.....	422
OFDI.....	423
OFDI_1.....	424
OFDT.....	425
OFDT_1.....	426
OFDT16.....	427
OFDT4.....	428
OFDT8.....	429
OFDX.....	430
OFDX_1.....	431
OFDX16.....	432
OFDX4.....	433
OFDX8.....	434
OFDXI.....	435
OFDXI_1.....	436
OR12.....	437
OR16.....	438
OR2.....	439
OR2B1.....	440



OR2B2.....	441
OR3.....	442
OR3B1.....	443
OR3B2.....	444
OR3B3.....	445
OR4.....	446
OR4B1.....	447
OR4B2.....	448
OR4B3.....	449
OR4B4.....	450
OR5.....	451
OR5B1.....	452
OR5B2.....	453
OR5B3.....	454
OR5B4.....	455
OR5B5.....	456
OR6.....	457
OR7.....	458
OR8.....	459
OR9.....	460
PULLDOWN.....	461
PULLUP.....	462
RAM16X1D.....	463
RAM16X1D_1.....	465
RAM16X1S.....	467
RAM16X1S_1.....	468
RAM16X2S.....	470
RAM16X4S.....	472
RAM16X8S.....	474
RAM32X1S.....	476
RAM32X1S_1.....	477
RAM32X2S.....	479
RAM32X4S.....	481
RAM32X8S.....	483
RAM64X1S.....	485
RAM64X1S_1.....	487
RAM64X2S.....	488
RAMB16_S1.....	490
RAMB16_S1_S1.....	493
RAMB16_S1_S18.....	500
RAMB16_S1_S2.....	507
RAMB16_S1_S36.....	514
RAMB16_S1_S4.....	521
RAMB16_S1_S9.....	528
RAMB16_S18.....	535
RAMB16_S18_S18.....	537
RAMB16_S18_S36.....	544
RAMB16_S2.....	551
RAMB16_S2_S18.....	553
RAMB16_S2_S2.....	560
RAMB16_S2_S36.....	567
RAMB16_S2_S4.....	574
RAMB16_S2_S9.....	581
RAMB16_S36.....	588
RAMB16_S36_S36.....	590
RAMB16_S4.....	597
RAMB16_S4_S18.....	599
RAMB16_S4_S36.....	606
RAMB16_S4_S4.....	613

RAMB16_S4_S9 .....	620
RAMB16_S9 .....	627
RAMB16_S9_S18.....	629
RAMB16_S9_S36.....	636
RAMB16_S9_S9 .....	643
ROM128X1 .....	650
ROM16X1.....	652
ROM256X1 .....	654
ROM32X1 .....	656
ROM64X1.....	658
SOP3.....	660
SOP3B1A .....	661
SOP3B1B .....	662
SOP3B2A .....	663
SOP3B2B .....	664
SOP3B3 .....	665
SOP4.....	666
SOP4B1 .....	667
SOP4B2A .....	668
SOP4B2B .....	669
SOP4B3 .....	670
SOP4B4 .....	671
SR16CE .....	672
SR16CLE.....	673
SR16CLED.....	675
SR16RE .....	677
SR16RLE .....	678
SR16RLED.....	680
SR4CE .....	682
SR4CLE.....	683
SR4CLED .....	685
SR4RE.....	687
SR4RLE .....	688
SR4RLED .....	690
SR8CE .....	692
SR8CLE.....	693
SR8CLED .....	695
SR8RE .....	697
SR8RLE .....	698
SR8RLED .....	700
SRL16 .....	702
SRL16_1 .....	704
SRL16E .....	706
SRL16E_1 .....	708
SRLC16.....	710
SRLC16_1.....	712
SRLC16E .....	714
SRLC16E_1.....	716
STARTBUF_SPARTAN3.....	718
STARTUP_SPARTAN3.....	719
VCC.....	720
XNOR2 .....	721
XNOR3 .....	722
XNOR4 .....	723
XNOR5 .....	724
XNOR6 .....	725
XNOR7 .....	726
XNOR8 .....	727
XNOR9 .....	728

---

XOR2 .....	729
XOR3 .....	730
XOR4 .....	731
XOR5 .....	732
XOR6 .....	733
XOR7 .....	734
XOR8 .....	735
XOR9 .....	736
XORCY .....	737
XORCY_D .....	738
XORCY_L .....	739



# About this Guide

This guide is part of the ISE documentation collection and covers the use of Xilinx design elements in schematics. A separate version of this guide is also available if you prefer to work with Verilog or VHDL in your circuit design activities.

This guide contains the following:

- A general introduction to the design elements, including descriptions of the types of elements available in this architecture.
- A list of pre-existing design elements are automatically changed by the ISE software tools when they are used in this architecture, thus ensuring that you are always able to take full advantage of the latest circuit design advances.
- A list of the design elements that are supported in this architecture, organized by functional categories. Click on the element of your choice to immediately access its profile.
- Individual profiles describing each of the primitives and macros, and including, as appropriate, for each element:
  - Its formal name
  - A brief introduction to each element, including the names of all architectures in which it is supported
  - Its schematic symbol
  - Logic tables (if any)
  - Port descriptions (if any)
  - A list of available attributes
  - References to any additional sources of information

## About this Architecture

This version of the Libraries Guide describes the categories of design elements that comprise the Xilinx Unified Libraries for this architecture. These categories are:

- **Primitives** - The simplest design elements in the Xilinx libraries. Primitives are the design element "atoms." Primitives can be created from primitives or macros. Examples of Xilinx primitives are the simple buffer, BUF, and the D flip-flop with clock enable and clear, FDCE.
- **Macros** - The design element "molecules" of the Xilinx libraries. Macros can be created from the design element primitives or macros. For example, the FD4CE flip-flop macro is a composite of 4 FDCE primitives.

Xilinx maintains software libraries with hundreds of functional design elements (unimacros and primitives) for different device architectures. New functional elements are assembled with each release of development system software. In addition to a comprehensive Unified Library containing all design elements, this guide is one in a series of architecture-specific libraries.



# Functional Categories

This section categorizes, by function, the circuit design elements described in detail later in this guide. The elements (*primitives* and *macros*) are listed in alphanumeric order under each functional category.

Arithmetic	Flip Flop	LUT
Buffer	General	Map
Carry Logic	IO	Memory
Comparator	IO FlipFlop	Mux
Counter	IO Latch	Shift Register
DDR Flip Flop	Latch	Shifter
Decoder	Logic	

## Arithmetic

Design Element	Description
ACC16	Macro: 16-Bit Loadable Cascadable Accumulator with Carry-In, Carry-Out, and Synchronous Reset
ACC4	Macro: 4-Bit Loadable Cascadable Accumulator with Carry-In, Carry-Out, and Synchronous Reset
ACC8	Macro: 8-Bit Loadable Cascadable Accumulator with Carry-In, Carry-Out, and Synchronous Reset
ADD16	Macro: 16-Bit Cascadable Full Adder with Carry-In, Carry-Out, and Overflow
ADD4	Macro: 4-Bit Cascadable Full Adder with Carry-In, Carry-Out, and Overflow
ADD8	Macro: 8-Bit Cascadable Full Adder with Carry-In, Carry-Out, and Overflow
ADSU16	Macro: 16-Bit Cascadable Adder/Subtractor with Carry-In, Carry-Out, and Overflow
ADSU4	Macro: 4-Bit Cascadable Adder/Subtractor with Carry-In, Carry-Out, and Overflow
ADSU8	Macro: 8-Bit Cascadable Adder/Subtractor with Carry-In, Carry-Out, and Overflow
MULT18X18	Primitive: 18 x 18 Signed Multiplier
MULT18X18S	Primitive: 18 x 18 Signed Multiplier -- Registered Version

## Buffer

Design Element	Description
BUF	Primitive: General Purpose Buffer
BUFCF	Primitive: Fast Connect Buffer
BUFG	Primitive: Global Clock Buffer
BUFGCE	Primitive: Global Clock Buffer with Clock Enable
BUFGCE_1	Primitive: Global Clock Buffer with Clock Enable and Output State 1
BUFGMUX	Primitive: Global Clock MUX Buffer

Design Element	Description
<a href="#">BUFGMUX_1</a>	Primitive: Global Clock MUX Buffer with Output State 1
<a href="#">BUFGP</a>	Primitive: Primary Global Buffer for Driving Clocks or Longlines (Four per PLD Device)

## Carry Logic

Design Element	Description
<a href="#">MUXCY</a>	Primitive: 2-to-1 Multiplexer for Carry Logic with General Output
<a href="#">MUXCY_D</a>	Primitive: 2-to-1 Multiplexer for Carry Logic with Dual Output
<a href="#">MUXCY_L</a>	Primitive: 2-to-1 Multiplexer for Carry Logic with Local Output
<a href="#">XORCY</a>	Primitive: XOR for Carry Logic with General Output
<a href="#">XORCY_D</a>	Primitive: XOR for Carry Logic with Dual Output
<a href="#">XORCY_L</a>	Primitive: XOR for Carry Logic with Local Output

## Comparator

Design Element	Description
<a href="#">COMP16</a>	Macro: 16-Bit Identity Comparator
<a href="#">COMP2</a>	Macro: 2-Bit Identity Comparator
<a href="#">COMP4</a>	Macro: 4-Bit Identity Comparator
<a href="#">COMP8</a>	Macro: 8-Bit Identity Comparator
<a href="#">COMPM16</a>	Macro: 16-Bit Magnitude Comparator
<a href="#">COMPM2</a>	Macro: 2-Bit Magnitude Comparator
<a href="#">COMPM4</a>	Macro: 4-Bit Magnitude Comparator
<a href="#">COMPM8</a>	Macro: 8-Bit Magnitude Comparator
<a href="#">COMPMC16</a>	Macro: 16-Bit Magnitude Comparator
<a href="#">COMPMC8</a>	Macro: 8-Bit Magnitude Comparator

## Counter

Design Element	Description
<a href="#">CB16CE</a>	Macro: 16-Bit Cascadable Binary Counter with Clock Enable and Asynchronous Clear
<a href="#">CB16CLE</a>	Macro: 16-Bit Loadable Cascadable Binary Counters with Clock Enable and Asynchronous Clear
<a href="#">CB16CLED</a>	Macro: 16-Bit Loadable Cascadable Bidirectional Binary Counters with Clock Enable and Asynchronous Clear
<a href="#">CB16RE</a>	Macro: 16-Bit Cascadable Binary Counter with Clock Enable and Synchronous Reset
<a href="#">CB2CE</a>	Macro: 2-Bit Cascadable Binary Counter with Clock Enable and Asynchronous Clear
<a href="#">CB2CLE</a>	Macro: 2-Bit Loadable Cascadable Binary Counters with Clock Enable and Asynchronous Clear



Design Element	Description
CB2CLED	Macro: 2-Bit Loadable Cascadable Bidirectional Binary Counters with Clock Enable and Asynchronous Clear
CB2RE	Macro: 2-Bit Cascadable Binary Counter with Clock Enable and Synchronous Reset
CB4CE	Macro: 4-Bit Cascadable Binary Counter with Clock Enable and Asynchronous Clear
CB4CLE	Macro: 4-Bit Loadable Cascadable Binary Counters with Clock Enable and Asynchronous Clear
CB4CLED	Macro: 4-Bit Loadable Cascadable Bidirectional Binary Counters with Clock Enable and Asynchronous Clear
CB4RE	Macro: 4-Bit Cascadable Binary Counter with Clock Enable and Synchronous Reset
CB8CE	Macro: 8-Bit Cascadable Binary Counter with Clock Enable and Asynchronous Clear
CB8CLE	Macro: 8-Bit Loadable Cascadable Binary Counters with Clock Enable and Asynchronous Clear
CB8CLED	Macro: 8-Bit Loadable Cascadable Bidirectional Binary Counters with Clock Enable and Asynchronous Clear
CB8RE	Macro: 8-Bit Cascadable Binary Counter with Clock Enable and Synchronous Reset
CC16CE	Macro: 16-Bit Cascadable Binary Counter with Clock Enable and Asynchronous Clear
CC16CLE	Macro: 16-Bit Loadable Cascadable Binary Counter with Clock Enable and Asynchronous Clear
CC16CLED	Macro: 16-Bit Loadable Cascadable Bidirectional Binary Counter with Clock Enable and Asynchronous Clear
CC16RE	Macro: 16-Bit Cascadable Binary Counter with Clock Enable and Synchronous Reset
CC8CE	Macro: 8-Bit Cascadable Binary Counter with Clock Enable and Asynchronous Clear
CC8CLE	Macro: 8-Bit Loadable Cascadable Binary Counter with Clock Enable and Asynchronous Clear
CC8CLED	Macro: 8-Bit Loadable Cascadable Bidirectional Binary Counter with Clock Enable and Asynchronous Clear
CC8RE	Macro: 8-Bit Cascadable Binary Counter with Clock Enable and Synchronous Reset
CD4CE	Macro: 4-Bit Cascadable BCD Counter with Clock Enable and Asynchronous Clear
CD4CLE	Macro: 4-Bit Loadable Cascadable BCD Counter with Clock Enable and Asynchronous Clear
CD4RE	Macro: 4-Bit Cascadable BCD Counter with Clock Enable and Synchronous Reset
CD4RLE	Macro: 4-Bit Loadable Cascadable BCD Counter with Clock Enable and Synchronous Reset
CJ4CE	Macro: 4-Bit Johnson Counter with Clock Enable and Asynchronous Clear
CJ4RE	Macro: 4-Bit Johnson Counter with Clock Enable and Synchronous Reset
CJ5CE	Macro: 5-Bit Johnson Counter with Clock Enable and Asynchronous Clear
CJ5RE	Macro: 5-Bit Johnson Counter with Clock Enable and Synchronous Reset
CJ8CE	Macro: 8-Bit Johnson Counter with Clock Enable and Asynchronous Clear
CJ8RE	Macro: 8-Bit Johnson Counter with Clock Enable and Synchronous Reset
CR16CE	Macro: 16-Bit Negative-Edge Binary Ripple Counter with Clock Enable and Asynchronous Clear
CR8CE	Macro: 8-Bit Negative-Edge Binary Ripple Counter with Clock Enable and Asynchronous Clear

## DDR Flip Flop

Design Element	Description
FDDRCPE	Primitive: Dual Data Rate D Flip-Flop with Clock Enable and Asynchronous Preset and Clear
FDDRRSE	Primitive: Dual Data Rate D Flip-Flop with Clock Enable and Synchronous Reset and Set
IFDDRCPE	Primitive: Dual Data Rate Input D Flip-Flop with Clock Enable and Asynchronous Preset and Clear
IFDDRRSE	Primitive: Dual Data Rate Input D Flip-Flop with Synchronous Reset and Set and Clock Enable
OFDDRCPE	Primitive: Dual Data Rate Output D Flip-Flop with Clock Enable and Asynchronous Preset and Clear
OFDDRRSE	Primitive: Dual Data Rate Output D Flip-Flop with Synchronous Reset and Set and Clock Enable
OFDDRTCPE	Primitive: Dual Data Rate D Flip-Flop with Active-Low 3--State Output Buffer, Clock Enable, and Asynchro-nous Preset and Clear
OFDDRTRSE	Primitive: Dual Data Rate D Flip-Flop with Active -Low 3-State Output Buffer, Synchronous Reset and Set, and Clock Enable

## Decoder

Design Element	Description
D2_4E	Macro: 2- to 4-Line Decoder/Demultiplexer with Enable
D3_8E	Macro: 3- to 8-Line Decoder/Demultiplexer with Enable
D4_16E	Macro: 4- to 16-Line Decoder/Demultiplexer with Enable
DEC_CC16	Macro: 16-Bit Active Low Decoder
DEC_CC4	Macro: 4-Bit Active Low Decoder
DEC_CC8	Macro: 8-Bit Active Low Decoder
DECODE16	Macro: 16-Bit Active-Low Decoder
DECODE32	Macro: 32-Bit Active-Low Decoder
DECODE4	Macro: 4-Bit Active-Low Decoder
DECODE64	Macro: 64-Bit Active-Low Decoder
DECODE8	Macro: 8-Bit Active-Low Decoder

## Flip Flop

Design Element	Description
FD	Primitive: D Flip-Flop
FD_1	Primitive: D Flip-Flop with Negative-Edge Clock
FD16CE	Macro: 16-Bit Data Register with Clock Enable and Asynchronous Clear
FD16RE	Macro: 16-Bit Data Register with Clock Enable and Synchronous Reset

Design Element	Description
FD4CE	Macro: 4-Bit Data Register with Clock Enable and Asynchronous Clear
FD4RE	Macro: 4-Bit Data Register with Clock Enable and Synchronous Reset
FD8CE	Macro: 8-Bit Data Register with Clock Enable and Asynchronous Clear
FD8RE	Macro: 8-Bit Data Register with Clock Enable and Synchronous Reset
FDC	Primitive: D Flip-Flop with Asynchronous Clear
FDC_1	Primitive: D Flip-Flop with Negative-Edge Clock and Asynchronous Clear
FDCE	Primitive: D Flip-Flop with Clock Enable and Asynchronous Clear
FDCE_1	Primitive: D Flip-Flop with Negative-Edge Clock, Clock Enable, and Asynchronous Clear
FDCP	Primitive: D Flip-Flop with Asynchronous Preset and Clear
FDCP_1	Primitive: D Flip-Flop with Negative-Edge Clock and Asynchronous Preset and Clear
FDCPE	Primitive: D Flip-Flop with Clock Enable and Asynchronous Preset and Clear
FDCPE_1	Primitive: D Flip-Flop with Negative-Edge Clock, Clock Enable, and Asynchronous Preset and Clear
FDE	Primitive: D Flip-Flop with Clock Enable
FDE_1	Primitive: D Flip-Flop with Negative-Edge Clock and Clock Enable
FDP	Primitive: D Flip-Flop with Asynchronous Preset
FDP_1	Primitive: D Flip-Flop with Negative-Edge Clock and Asynchronous Preset
FDPE	Primitive: D Flip-Flop with Clock Enable and Asynchronous Preset
FDPE_1	Primitive: D Flip-Flop with Negative-Edge Clock, Clock Enable, and Asynchronous Preset
FDR	Primitive: D Flip-Flop with Synchronous Reset
FDR_1	Primitive: D Flip-Flop with Negative-Edge Clock and Synchronous Reset
FDRE	Primitive: D Flip-Flop with Clock Enable and Synchronous Reset
FDRE_1	Primitive: D Flip-Flop with Negative-Clock Edge, Clock Enable, and Synchronous Reset
FDRS	Primitive: D Flip-Flop with Synchronous Reset and Set
FDRS_1	Primitive: D Flip-Flop with Negative-Clock Edge and Synchronous Reset and Set
FDRSE	Primitive: D Flip-Flop with Synchronous Reset and Set and Clock Enable
FDRSE_1	Primitive: D Flip-Flop with Negative-Clock Edge, Synchronous Reset and Set, and Clock Enable
FDS	Primitive: D Flip-Flop with Synchronous Set
FDS_1	Primitive: D Flip-Flop with Negative-Edge Clock and Synchronous Set
FDSE	Primitive: D Flip-Flop with Clock Enable and Synchronous Set
FDSE_1	Primitive: D Flip-Flop with Negative-Edge Clock, Clock Enable, and Synchronous Set
FJKC	Macro: J-K Flip-Flop with Asynchronous Clear
FJKCE	Macro: J-K Flip-Flop with Clock Enable and Asynchronous Clear
FJKP	Macro: J-K Flip-Flop with Asynchronous Preset
FJKPE	Macro: J-K Flip-Flop with Clock Enable and Asynchronous Preset
FJKRSE	Macro: J-K Flip-Flop with Clock Enable and Synchronous Reset and Set

Design Element	Description
<a href="#">FJKSRE</a>	Macro: J-K Flip-Flop with Clock Enable and Synchronous Set and Reset
<a href="#">FTC</a>	Macro: Toggle Flip-Flop with Asynchronous Clear
<a href="#">FTCE</a>	Macro: Toggle Flip-Flop with Clock Enable and Asynchronous Clear
<a href="#">FTCLE</a>	Macro: Toggle/Loadable Flip-Flop with Clock Enable and Asynchronous Clear
<a href="#">FTCLEX</a>	Macro: Toggle/Loadable Flip-Flop with Clock Enable and Asynchronous Clear
<a href="#">FTP</a>	Macro: Toggle Flip-Flop with Asynchronous Preset
<a href="#">FTPE</a>	Macro: Toggle Flip-Flop with Clock Enable and Asynchronous Preset
<a href="#">FTPLE</a>	Macro: Toggle/Loadable Flip-Flop with Clock Enable and Asynchronous Preset
<a href="#">FTRSE</a>	Macro: Toggle Flip-Flop with Clock Enable and Synchronous Reset and Set
<a href="#">FTRSLE</a>	Macro: Toggle/Loadable Flip-Flop with Clock Enable and Synchronous Reset and Set
<a href="#">FTSRE</a>	Macro: Toggle Flip-Flop with Clock Enable and Synchronous Set and Reset
<a href="#">FTRSLE</a>	Macro: Toggle/Loadable Flip-Flop with Clock Enable and Synchronous Set and Reset

## General

Design Element	Description
<a href="#">BSCAN_SPARTAN3</a>	Primitive: Spartan-3 Register State Capture for Bitstream Readback
<a href="#">CAPTURE_SPARTAN3</a>	Primitive: Spartan-3 Register State Capture for Bitstream Readback
<a href="#">DCM</a>	Primitive: Digital Clock Manager
<a href="#">GND</a>	Primitive: Ground-Connection Signal Tag
<a href="#">KEEPER</a>	Primitive: KEEPER Symbol
<a href="#">PULLDOWN</a>	Primitive: Resistor to GND for Input Pads, Open-Drain, and 3-State Outputs
<a href="#">PULLUP</a>	Primitive: Resistor to VCC for Input PADS, Open-Drain, and 3-State Outputs
<a href="#">STARTBUF_SPARTAN3</a>	Primitive: VHDL Simulation of FPGA Designs
<a href="#">STARTUP_SPARTAN3</a>	Primitive: Spartan-3 User Interface to Global Clock, Reset, and 3-State Controls
<a href="#">VCC</a>	Primitive: VCC-Connection Signal Tag

## IO

Design Element	Description
<a href="#">IBUF</a>	Primitive: Input Buffer
<a href="#">IBUF16</a>	Macro: 16-Bit Input Buffer
<a href="#">IBUF4</a>	Macro: 4-Bit Input Buffer
<a href="#">IBUF8</a>	Macro: 8-Bit Input Buffer
<a href="#">IBUFDS</a>	Primitive: Differential Signaling Input Buffer with Optional Delay
<a href="#">IBUFG</a>	Primitive: Dedicated Input Clock Buffer
<a href="#">IBUFGDS</a>	Primitive: Differential Signaling Dedicated Input Clock Buffer and Optional Delay
<a href="#">IOBUF</a>	Primitive: Bi-Directional Buffer

Design Element	Description
IOBUFDS	Primitive: 3-State Differential Signaling I/O Buffer with Active Low Output Enable
OBUF	Primitive: Output Buffer
OBUF16	Macro: 16-Bit Output Buffer
OBUF4	Macro: 4-Bit Output Buffer
OBUF8	Macro: 8-Bit Output Buffer
OBUFDS	Primitive: Differential Signaling Output Buffer
OBUFT	Primitive: 3-State Output Buffer with Active Low Output Enable
OBUFTDS	Primitive: 3-State Output Buffer with Differential Signaling, Active-Low Output Enable

## IO FlipFlop

Design Element	Description
IFD	Macro: Input D Flip-Flop
IFD_1	Macro: Input D Flip-Flop with Inverted Clock (Asynchronous Preset)
IFD16	Macro: 16-Bit Input D Flip-Flop
IFD4	Macro: 4-Bit Input D Flip-Flop
IFD8	Macro: 8-Bit Input D Flip-Flop
IFDI	Macro: Input D Flip-Flop (Asynchronous Preset)
IFDI_1	Macro: Input D Flip-Flop with Inverted Clock (Asynchronous Preset)
IFDX	Macro: Input D Flip-Flop with Clock Enable
IFDX_1	Macro: Input D Flip-Flop with Inverted Clock and Clock Enable
IFDX16	Macro: 16-Bit Input D Flip-Flops with Clock Enable
IFDX4	Macro: 4-Bit Input D Flip-Flop with Clock Enable
IFDX8	Macro: 8-Bit Input D Flip-Flop with Clock Enable
IFDXI	Macro: Input D Flip-Flop with Clock Enable (Asynchronous Preset)
IFDXI_1	Macro: Input D Flip-Flop with Inverted Clock and Clock Enable (Asynchronous Preset)
OFD	Macro: Output D Flip-Flop
OFD_1	Macro: Output D Flip-Flop with Inverted Clock
OFD16	Macro: 16-Bit Output D Flip-Flop
OFD4	Macro: 4-Bit Output D Flip-Flop
OFD8	Macro: 8-Bit Output D Flip-Flop
OFDE	Macro: D Flip-Flop with Active-High Enable Output Buffers
OFDE_1	Macro: D Flip-Flop with Active-High Enable Output Buffer and Inverted Clock
OFDE16	Macro: 16-Bit D Flip-Flop with Active-High Enable Output Buffers
OFDE4	Macro: 4-Bit D Flip-Flop with Active-High Enable Output Buffers
OFDE8	Macro: 8-Bit D Flip-Flop with Active-High Enable Output Buffers
OFDI	Macro: Output D Flip-Flop (Asynchronous Preset)
OFDI_1	Macro: Output D Flip-Flop with Inverted Clock (Asynchronous Preset)

Design Element	Description
OFDT	Macro: D Flip-Flop with Active-Low 3-State Output Buffer
OFDT_1	Macro: D Flip-Flop with Active-Low 3-State Output Buffer and Inverted Clock
OFDT16	Macro: 16-Bit D Flip-Flop with Active-Low 3-State Output Buffers
OFDT4	Macro: 4-Bit D Flip-Flop with Active-Low 3-State Output Buffers
OFDT8	Macro: 8-Bit D Flip-Flop with Active-Low 3-State Output Buffers
OFDX	Macro: Output D Flip-Flop with Clock Enable
OFDX_1	Macro: Output D Flip-Flop with Inverted Clock and Clock Enable
OFDX16	Macro: 16-Bit Output D Flip-Flop with Clock Enable
OFDX4	Macro: 4-Bit Output D Flip-Flop with Clock Enable
OFDX8	Macro: 8-Bit Output D Flip-Flop with Clock Enable
OFDXI	Macro: Output D Flip-Flop with Clock Enable (Asynchronous Preset)
OFDXI_1	Macro: Output D Flip-Flop with Inverted Clock and Clock Enable (Asynchronous Preset)

## IO Latch

Design Element	Description
ILD	Macro: Transparent Input Data Latch
ILD_1	Macro: Transparent Input Data Latch with Inverted Gate
ILD16	Macro: Transparent Input Data Latch
ILD4	Macro: Transparent Input Data Latch
ILD8	Macro: Transparent Input Data Latch
ILDI	Macro: Transparent Input Data Latch (Asynchronous Preset)
ILDI_1	Macro: Transparent Input Data Latch with Inverted Gate (Asynchronous Preset)
ILDX	Macro: Transparent Input Data Latch
ILDX_1	Macro: Transparent Input Data Latch with Inverted Gate
ILDX16	Macro: Transparent Input Data Latch
ILDX4	Macro: Transparent Input Data Latch
ILDX8	Macro: Transparent Input Data Latch
ILDXI	Macro: Transparent Input Data Latch (Asynchronous Preset)
ILDXI_1	Macro: Transparent Input Data Latch with Inverted Gate (Asynchronous Preset)

## Latch

Design Element	Description
LD	Primitive: Transparent Data Latch
LD_1	Primitive: Transparent Data Latch with Inverted Gate
LD16	Macro: Multiple Transparent Data Latch
LD16CE	Macro: Transparent Data Latch with Asynchronous Clear and Gate Enable

Design Element	Description
LD4	Macro: Multiple Transparent Data Latch
LD4CE	Macro: Transparent Data Latch with Asynchronous Clear and Gate Enable
LD8	Macro: Multiple Transparent Data Latch
LD8CE	Macro: Transparent Data Latch with Asynchronous Clear and Gate Enable
LDC	Primitive: Transparent Data Latch with Asynchronous Clear
LDC_1	Primitive: Transparent Data Latch with Asynchronous Clear and Inverted Gate
LDCE	Primitive: Transparent Data Latch with Asynchronous Clear and Gate Enable
LDCE_1	Primitive: Transparent Data Latch with Asynchronous Clear, Gate Enable, and Inverted Gate
LDCP	Primitive: Transparent Data Latch with Asynchronous Clear and Preset
LDCP_1	Primitive: Transparent Data Latch with Asynchronous Clear and Preset and Inverted Gate
LDCPE	Primitive: Transparent Data Latch with Asynchronous Clear and Preset and Gate Enable
LDCPE_1	Primitive: Transparent Data Latch with Asynchronous Clear and Preset, Gate Enable, and Inverted Gate
LDE	Primitive: Transparent Data Latch with Gate Enable
LDE_1	Primitive: Transparent Data Latch with Gate Enable and Inverted Gate
LDP	Primitive: Transparent Data Latch with Asynchronous Preset
LDP_1	Primitive: Transparent Data Latch with Asynchronous Preset and Inverted Gate
LDPE	Primitive: Transparent Data Latch with Asynchronous Preset and Gate Enable
LDPE_1	Primitive: Transparent Data Latch with Asynchronous Preset, Gate Enable, and Inverted Gate

## Logic

Design Element	Description
AND12	Macro: 12- Input AND Gate with Non-Inverted Inputs
AND16	Macro: 16- Input AND Gate with Non-Inverted Inputs
AND2	Primitive: 2-Input AND Gate with Non-Inverted Inputs
AND2B1	Primitive: 2-Input AND Gate with 1 Inverted and 1 Non-Inverted Inputs
AND2B2	Primitive: 2-Input AND Gate with Inverted Inputs
AND3	Primitive: 3-Input AND Gate with Non-Inverted Inputs
AND3B1	Primitive: 3-Input AND Gate with 1 Inverted and 2 Non-Inverted Inputs
AND3B2	Primitive: 3-Input AND Gate with 2 Inverted and 1 Non-Inverted Inputs
AND3B3	Primitive: 3-Input AND Gate with Inverted Inputs
AND4	Primitive: 4-Input AND Gate with Non-Inverted Inputs
AND4B1	Primitive: 4-Input AND Gate with 1 Inverted and 3 Non-Inverted Inputs
AND4B2	Primitive: 4-Input AND Gate with 2 Inverted and 2 Non-Inverted Inputs
AND4B3	Primitive: 4-Input AND Gate with 3 Inverted and 1 Non-Inverted Inputs

Design Element	Description
AND4B4	Primitive: 4-Input AND Gate with Inverted Inputs
AND5	Primitive: 5-Input AND Gate with Non-Inverted Inputs
AND5B1	Primitive: 5-Input AND Gate with 1 Inverted and 4 Non-Inverted Inputs
AND5B2	Primitive: 5-Input AND Gate with 2 Inverted and 3 Non-Inverted Inputs
AND5B3	Primitive: 5-Input AND Gate with 3 Inverted and 2 Non-Inverted Inputs
AND5B4	Primitive: 5-Input AND Gate with 4 Inverted and 1 Non-Inverted Inputs
AND5B5	Primitive: 5-Input AND Gate with Inverted Inputs
AND6	Macro: 6-Input AND Gate with Non-Inverted Inputs
AND7	Macro: 7-Input AND Gate with Non-Inverted Inputs
AND8	Macro: 8-Input AND Gate with Non-Inverted Inputs
AND9	Macro: 9-Input AND Gate with Non-Inverted Inputs
INV	Primitive: Inverter
INV16	Macro: 16 Inverters
INV4	Macro: Four Inverters
INV8	Macro: Eight Inverters
MULT_AND	Primitive: Fast Multiplier AND
NAND12	Macro: 12- Input NAND Gate with Non-Inverted Inputs
NAND16	Macro: 16- Input NAND Gate with Non-Inverted Inputs
NAND2	Primitive: 2-Input NAND Gate with Non-Inverted Inputs
NAND2B1	Primitive: 2-Input NAND Gate with 1 Inverted and 1 Non-Inverted Inputs
NAND2B2	Primitive: 2-Input NAND Gate with Inverted Inputs
NAND3	Primitive: 3-Input NAND Gate with Non-Inverted Inputs
NAND3B1	Primitive: 3-Input NAND Gate with 1 Inverted and 2 Non-Inverted Inputs
NAND3B2	Primitive: 3-Input NAND Gate with 2 Inverted and 1 Non-Inverted Inputs
NAND3B3	Primitive: 3-Input NAND Gate with Inverted Inputs
NAND4	Primitive: 4-Input NAND Gate with Non-Inverted Inputs
NAND4B1	Primitive: 4-Input NAND Gate with 1 Inverted and 3 Non-Inverted Inputs
NAND4B2	Primitive: 4-Input NAND Gate with 2 Inverted and 2 Non-Inverted Inputs
NAND4B3	Primitive: 4-Input NAND Gate with 3 Inverted and 1 Non-Inverted Inputs
NAND4B4	Primitive: 4-Input NAND Gate with Inverted Inputs
NAND5	Primitive: 5-Input NAND Gate with Non-Inverted Inputs
NAND5B1	Primitive: 5-Input NAND Gate with 1 Inverted and 4 Non-Inverted Inputs
NAND5B2	Primitive: 5-Input NAND Gate with 2 Inverted and 3 Non-Inverted Inputs
NAND5B3	Primitive: 5-Input NAND Gate with 3 Inverted and 2 Non-Inverted Inputs
NAND5B4	Primitive: 5-Input NAND Gate with 4 Inverted and 1 Non-Inverted Inputs
NAND5B5	Primitive: 5-Input NAND Gate with Inverted Inputs
NAND6	Macro: 6-Input NAND Gate with Non-Inverted Inputs
NAND7	Macro: 7-Input NAND Gate with Non-Inverted Inputs



Design Element	Description
NAND8	Macro: 8-Input NAND Gate with Non-Inverted Inputs
NAND9	Macro: 9-Input NAND Gate with Non-Inverted Inputs
NOR12	Macro: 12-Input NOR Gate with Non-Inverted Inputs
NOR16	Macro: 16-Input NOR Gate with Non-Inverted Inputs
NOR2	Primitive: 2-Input NOR Gate with Non-Inverted Inputs
NOR2B1	Primitive: 2-Input NOR Gate with 1 Inverted and 1 Non-Inverted Inputs
NOR2B2	Primitive: 2-Input NOR Gate with Inverted Inputs
NOR3	Primitive: 3-Input NOR Gate with Non-Inverted Inputs
NOR3B1	Primitive: 3-Input NOR Gate with 1 Inverted and 2 Non-Inverted Inputs
NOR3B2	Primitive: 3-Input NOR Gate with 2 Inverted and 1 Non-Inverted Inputs
NOR3B3	Primitive: 3-Input NOR Gate with Inverted Inputs
NOR4	Primitive: 4-Input NOR Gate with Non-Inverted Inputs
NOR4B1	Primitive: 4-Input NOR Gate with 1 Inverted and 3 Non-Inverted Inputs
NOR4B2	Primitive: 4-Input NOR Gate with 2 Inverted and 2 Non-Inverted Inputs
NOR4B3	Primitive: 4-Input NOR Gate with 3 Inverted and 1 Non-Inverted Inputs
NOR4B4	Primitive: 4-Input NOR Gate with Inverted Inputs
NOR5	Primitive: 5-Input NOR Gate with Non-Inverted Inputs
NOR5B1	Primitive: 5-Input NOR Gate with 1 Inverted and 4 Non-Inverted Inputs
NOR5B2	Primitive: 5-Input NOR Gate with 2 Inverted and 3 Non-Inverted Inputs
NOR5B3	Primitive: 5-Input NOR Gate with 3 Inverted and 2 Non-Inverted Inputs
NOR5B4	Primitive: 5-Input NOR Gate with 4 Inverted and 1 Non-Inverted Inputs
NOR5B5	Primitive: 5-Input NOR Gate with Inverted Inputs
NOR6	Macro: 6-Input NOR Gate with Non-Inverted Inputs
NOR7	Macro: 7-Input NOR Gate with Non-Inverted Inputs
NOR8	Macro: 8-Input NOR Gate with Non-Inverted Inputs
NOR9	Macro: 9-Input NOR Gate with Non-Inverted Inputs
OR12	Macro: 12-Input OR Gate with Non-Inverted Inputs
OR16	Macro: 16-Input OR Gate with Non-Inverted Inputs
OR2	Primitive: 2-Input OR Gate with Non-Inverted Inputs
OR2B1	Primitive: 2-Input OR Gate with 1 Inverted and 1 Non-Inverted Inputs
OR2B2	Primitive: 2-Input OR Gate with Inverted Inputs
OR3	Primitive: 3-Input OR Gate with Non-Inverted Inputs
OR3B1	Primitive: 3-Input OR Gate with 1 Inverted and 2 Non-Inverted Inputs
OR3B2	Primitive: 3-Input OR Gate with 2 Inverted and 1 Non-Inverted Inputs
OR3B3	Primitive: 3-Input OR Gate with Inverted Inputs
OR4	Primitive: 4-Input OR Gate with Non-Inverted Inputs
OR4B1	Primitive: 4-Input OR Gate with 1 Inverted and 3 Non-Inverted Inputs
OR4B2	Primitive: 4-Input OR Gate with 2 Inverted and 2 Non-Inverted Inputs

Design Element	Description
OR4B3	Primitive: 4-Input OR Gate with 3 Inverted and 1 Non-Inverted Inputs
OR4B4	Primitive: 4-Input OR Gate with Inverted Inputs
OR5	Primitive: 5-Input OR Gate with Non-Inverted Inputs
OR5B1	Primitive: 5-Input OR Gate with 1 Inverted and 4 Non-Inverted Inputs
OR5B2	Primitive: 5-Input OR Gate with 2 Inverted and 3 Non-Inverted Inputs
OR5B3	Primitive: 5-Input OR Gate with 3 Inverted and 2 Non-Inverted Inputs
OR5B4	Primitive: 5-Input OR Gate with 4 Inverted and 1 Non-Inverted Inputs
OR5B5	Primitive: 5-Input OR Gate with Inverted Inputs
OR6	Macro: 6-Input OR Gate with Non-Inverted Inputs
OR7	Macro: 7-Input OR Gate with Non-Inverted Inputs
OR8	Macro: 8-Input OR Gate with Non-Inverted Inputs
OR9	Macro: 9-Input OR Gate with Non-Inverted Inputs
SOP3	Macro: Sum of Products
SOP3B1A	Macro: Sum of Products
SOP3B1B	Macro: Sum of Products
SOP3B2A	Macro: Sum of Products
SOP3B2B	Macro: Sum of Products
SOP3B3	Macro: Sum of Products
SOP4	Macro: Sum of Products
SOP4B1	Macro: Sum of Products
SOP4B2A	Macro: Sum of Products
SOP4B2B	Macro: Sum of Products
SOP4B3	Macro: Sum of Products
SOP4B4	Macro: Sum of Products
XNOR2	Primitive: 2-Input XNOR Gate with Non-Inverted Inputs
XNOR3	Primitive: 3-Input XNOR Gate with Non-Inverted Inputs
XNOR4	Primitive: 4-Input XNOR Gate with Non-Inverted Inputs
XNOR5	Primitive: 5-Input XNOR Gate with Non-Inverted Inputs
XNOR6	Macro: 6-Input XNOR Gate with Non-Inverted Inputs
XNOR7	Macro: 7-Input XNOR Gate with Non-Inverted Inputs
XNOR8	Macro: 8-Input XNOR Gate with Non-Inverted Inputs
XNOR9	Macro: 9-Input XNOR Gate with Non-Inverted Inputs
XOR2	Primitive: 2-Input XOR Gate with Non-Inverted Inputs
XOR3	Primitive: 3-Input XOR Gate with Non-Inverted Inputs
XOR4	Primitive: 4-Input XOR Gate with Non-Inverted Inputs
XOR5	Primitive: 5-Input XOR Gate with Non-Inverted Inputs
XOR6	Macro: 6-Input XOR Gate with Non-Inverted Inputs
XOR7	Macro: 7-Input XOR Gate with Non-Inverted Inputs

Design Element	Description
<a href="#">XOR8</a>	Macro: 8-Input XOR Gate with Non-Inverted Inputs
<a href="#">XOR9</a>	Macro: 9-Input XOR Gate with Non-Inverted Inputs

## LUT

Design Element	Description
<a href="#">LUT1</a>	Primitive: 1-Bit Look-Up-Table with General Output
<a href="#">LUT1_D</a>	Primitive: 1-Bit Look-Up-Table with Dual Output
<a href="#">LUT1_L</a>	Primitive: 1-Bit Look-Up-Table with Local Output
<a href="#">LUT2</a>	Primitive: 2-Bit Look-Up-Table with General Output
<a href="#">LUT2_D</a>	Primitive: 2-Bit Look-Up-Table with Dual Output
<a href="#">LUT2_L</a>	Primitive: 2-Bit Look-Up-Table with Local Output
<a href="#">LUT3</a>	Primitive: 3-Bit Look-Up-Table with General Output
<a href="#">LUT3_D</a>	Primitive: 3-Bit Look-Up-Table with Dual Output
<a href="#">LUT3_L</a>	Primitive: 3-Bit Look-Up-Table with Local Output
<a href="#">LUT4</a>	Primitive: 4-Bit Look-Up-Table with General Output
<a href="#">LUT4_D</a>	Primitive: 4-Bit Look-Up-Table with Dual Output
<a href="#">LUT4_L</a>	Primitive: 4-Bit Look-Up-Table with Local Output

## Map

Design Element	Description
<a href="#">FMAP</a>	Primitive: F Function Generator Partitioning Control Symbol

## Memory

Design Element	Description
<a href="#">RAM16X1D</a>	Primitive: 16-Deep by 1-Wide Static Dual Port Synchronous RAM
<a href="#">RAM16X1D_1</a>	Primitive: 16-Deep by 1-Wide Static Dual Port Synchronous RAM with Negative-Edge Clock
<a href="#">RAM16X1S</a>	Primitive: 16-Deep by 1-Wide Static Synchronous RAM
<a href="#">RAM16X1S_1</a>	Primitive: 16-Deep by 1-Wide Static Synchronous RAM with Negative-Edge Clock
<a href="#">RAM16X2S</a>	Primitive: 16-Deep by 2-Wide Static Synchronous RAM
<a href="#">RAM16X4S</a>	Primitive: 16-Deep by 4-Wide Static Synchronous RAM
<a href="#">RAM16X8S</a>	Primitive: 16-Deep by 8-Wide Static Synchronous RAM
<a href="#">RAM32X1S</a>	Primitive: 32-Deep by 1-Wide Static Synchronous RAM
<a href="#">RAM32X1S_1</a>	Primitive: 32-Deep by 1-Wide Static Synchronous RAM with Negative-Edge Clock
<a href="#">RAM32X2S</a>	Primitive: 32-Deep by 2-Wide Static Synchronous RAM
<a href="#">RAM32X4S</a>	Primitive: 32-Deep by 4-Wide Static Synchronous RAM

Design Element	Description
RAM32X8S	Primitive: 32-Deep by 8-Wide Static Synchronous RAM
RAM64X1S	Primitive: 64-Deep by 1-Wide Static Synchronous RAM
RAM64X1S_1	Primitive: 64-Deep by 1-Wide Static Synchronous RAM with Negative-Edge Clock
RAM64X2S	Primitive: 64-Deep by 2-Wide Static Synchronous RAM
RAMB16_S1	Primitive: 16K-bit Data and 2K-bit Parity Single-Port Synchronous Block RAM with 1-bit Port
RAMB16_S1_S1	Primitive: 16K-bit Data and 2K-bit Parity Dual-Port Synchronous Block RAM with 1-bit Ports
RAMB16_S1_S18	Primitive: 16K-bit Data and 2K-bit Parity Dual-Port Synchronous Block RAM with 1-bit and 18-bit Ports
RAMB16_S1_S2	Primitive: 16K-bit Data and 2K-bit Parity Dual-Port Synchronous Block RAM with 1-bit and 2-bit Ports
RAMB16_S1_S36	Primitive: 16K-bit Data and 2K-bit Parity Dual-Port Synchronous Block RAM with 1-bit and 36-bit Ports
RAMB16_S1_S4	Primitive: 16K-bit Data and 2K-bit Parity Dual-Port Synchronous Block RAM with 1-bit and 4-bit Ports
RAMB16_S1_S9	Primitive: 16K-bit Data and 2K-bit Parity Dual-Port Synchronous Block RAM with 1-bit and 9-bit Ports
RAMB16_S18	Primitive: 16K-bit Data + 2K-bit Parity Memory, Single-Port Synchronous Block RAM with 18-bit Port
RAMB16_S18_S18	Primitive: 16K-bit Data and 2K-bit Parity Dual-Port Synchronous Block RAM with 18-bit Ports
RAMB16_S18_S36	Primitive: 16K-bit Data and 2K-bit Parity Dual-Port Synchronous Block RAM with 18-bit and 36-bit Ports
RAMB16_S2	Primitive: 16K-bit Data and 2K-bit Parity Single-Port Synchronous Block RAM with 2-bit Port
RAMB16_S2_S18	Primitive: 16K-bit Data and 2K-bit Parity Dual-Port Synchronous Block RAM with 2-bit and 18-bit Ports
RAMB16_S2_S2	Primitive: 16K-bit Data and 2K-bit Parity Dual-Port Synchronous Block RAM with 2-bit Ports
RAMB16_S2_S36	Primitive: 16K-bit Data and 2K-bit Parity Dual-Port Synchronous Block RAM with 2-bit and 36-bit Ports
RAMB16_S2_S4	Primitive: 16K-bit Data and 2K-bit Parity Dual-Port Synchronous Block RAM with 2-bit and 4-bit Ports
RAMB16_S2_S9	Primitive: 16K-bit Data and 2K-bit Parity Dual-Port Synchronous Block RAM with 2-bit and 9-bit Ports
RAMB16_S36	Primitive: 16K-bit Data and 2K-bit Parity Single-Port Synchronous Block RAM with 36-bit Port
RAMB16_S36_S36	Primitive: 16K-bit Data and 2K-bit Parity Dual-Port Synchronous Block RAM with Two 36-bit Ports
RAMB16_S4	Primitive: 16K-bit Data and 2K-bit Parity Single-Port Synchronous Block RAM with 4-bit Port
RAMB16_S4_S18	Primitive: 16K-bit Data and 2K-bit Parity Dual-Port Synchronous Block RAM with 4-bit and 18-bit Ports
RAMB16_S4_S36	Primitive: 16K-bit Data and 2K-bit Parity Dual-Port Synchronous Block RAM with 4-bit and 36-bit Ports

Design Element	Description
<a href="#">RAMB16_S4_S4</a>	Primitive: 16K-bit Data and 2K-bit Parity Dual-Port Synchronous Block RAM with 4-bit Ports
<a href="#">RAMB16_S4_S9</a>	Primitive: 16K-bit Data and 2K-bit Parity Dual-Port Synchronous Block RAM with 4-bit and 9-bit Ports
<a href="#">RAMB16_S9</a>	Primitive: 16K-bit Data and 2K-bit Parity Single-Port Synchronous Block RAM with 9-bit Port
<a href="#">RAMB16_S9_S18</a>	Primitive: 16K-bit Data and 2K-bit Parity Dual-Port Synchronous Block RAM with 9-bit and 18-bit Ports
<a href="#">RAMB16_S9_S36</a>	Primitive: 16K-bit Data and 2K-bit Parity Dual-Port Synchronous Block RAM with 9-bit and 36-bit Ports
<a href="#">RAMB16_S9_S9</a>	Primitive: 16K-bit Data and 2K-bit Parity Dual-Port Synchronous Block RAM with 9-bit Ports
<a href="#">ROM128X1</a>	Primitive: 128-Deep by 1-Wide ROM
<a href="#">ROM16X1</a>	Primitive: 16-Deep by 1-Wide ROM
<a href="#">ROM256X1</a>	Primitive: 256-Deep by 1-Wide ROM
<a href="#">ROM32X1</a>	Primitive: 32-Deep by 1-Wide ROM
<a href="#">ROM64X1</a>	Primitive: 64-Deep by 1-Wide ROM

## Mux

Design Element	Description
<a href="#">M16_1E</a>	Macro: 16-to-1 Multiplexer with Enable
<a href="#">M2_1</a>	Macro: 2-to-1 Multiplexer
<a href="#">M2_1B1</a>	Macro: 2-to-1 Multiplexer with D0 Inverted
<a href="#">M2_1B2</a>	Macro: 2-to-1 Multiplexer with D0 and D1 Inverted
<a href="#">M2_1E</a>	Macro: 2-to-1 Multiplexer with Enable
<a href="#">M4_1E</a>	Macro: 4-to-1 Multiplexer with Enable
<a href="#">M8_1E</a>	Macro: 8-to-1 Multiplexer with Enable
<a href="#">MUXF5</a>	Primitive: 2-to-1 Look-Up Table Multiplexer with General Output
<a href="#">MUXF5_D</a>	Primitive: 2-to-1 Look-Up Table Multiplexer with Dual Output
<a href="#">MUXF5_L</a>	Primitive: 2-to-1 Look-Up Table Multiplexer with Local Output
<a href="#">MUXF6</a>	Primitive: 2-to-1 Look-Up Table Multiplexer with General Output
<a href="#">MUXF6_D</a>	Primitive: 2-to-1 Look-Up Table Multiplexer with Dual Output
<a href="#">MUXF6_L</a>	Primitive: 2-to-1 Look-Up Table Multiplexer with Local Output
<a href="#">MUXF7</a>	Primitive: 2-to-1 Look-Up Table Multiplexer with General Output
<a href="#">MUXF7_D</a>	Primitive: 2-to-1 Look-Up Table Multiplexer with Dual Output
<a href="#">MUXF7_L</a>	Primitive: 2-to-1 Look-Up Table Multiplexer with Local Output
<a href="#">MUXF8</a>	Primitive: 2-to-1 Look-Up Table Multiplexer with General Output
<a href="#">MUXF8_D</a>	Primitive: 2-to-1 Look-Up Table Multiplexer with Dual Output
<a href="#">MUXF8_L</a>	Primitive: 2-to-1 Look-Up Table Multiplexer with Local Output

## Shift Register

Design Element	Description
SR16CE	Macro: 16-Bit Serial-In Parallel-Out Shift Register with Clock Enable and Asynchronous Clear
SR16CLE	Macro: 16-Bit Loadable Serial/Parallel-In Parallel-Out Shift Register with Clock Enable and Asynchronous Clear
SR16CLED	Macro: 16-Bit Shift Register with Clock Enable and Asynchronous Clear
SR16RE	Macro: 16-Bit Serial-In Parallel-Out Shift Register with Clock Enable and Synchronous Reset
SR16RLE	Macro: 16-Bit Loadable Serial/Parallel-In Parallel-Out Shift Register with Clock Enable and Synchronous Reset
SR16RLED	Macro: 16-Bit Shift Register with Clock Enable and Synchronous Reset
SR4CE	Macro: 4-Bit Serial-In Parallel-Out Shift Register with Clock Enable and Asynchronous Clear
SR4CLE	Macro: 4-Bit Loadable Serial/Parallel-In Parallel-Out Shift Register with Clock Enable and Asynchronous Clear
SR4CLED	Macro: 4-Bit Shift Register with Clock Enable and Asynchronous Clear
SR4RE	Macro: 4-Bit Serial-In Parallel-Out Shift Register with Clock Enable and Synchronous Reset
SR4RLE	Macro: 4-Bit Loadable Serial/Parallel-In Parallel-Out Shift Register with Clock Enable and Synchronous Reset
SR4RLED	Macro: 4-Bit Shift Register with Clock Enable and Synchronous Reset
SR8CE	Macro: 8-Bit Serial-In Parallel-Out Shift Register with Clock Enable and Asynchronous Clear
SR8CLE	Macro: 8-Bit Loadable Serial/Parallel-In Parallel-Out Shift Register with Clock Enable and Asynchronous Clear
SR8CLED	Macro: 8-Bit Shift Register with Clock Enable and Asynchronous Clear
SR8RE	Macro: 8-Bit Serial-In Parallel-Out Shift Register with Clock Enable and Synchronous Reset
SR8RLE	Macro: 8-Bit Loadable Serial/Parallel-In Parallel-Out Shift Register with Clock Enable and Synchronous Reset
SR8RLED	Macro: 8-Bit Shift Register with Clock Enable and Synchronous Reset
SRL16	Primitive: 16-Bit Shift Register Look-Up-Table (LUT)
SRL16_1	Primitive: 16-Bit Shift Register Look-Up-Table (LUT) with Negative-Edge Clock
SRL16E	Primitive: 16-Bit Shift Register Look-Up-Table (LUT) with Clock Enable
SRL16E_1	Primitive: 16-Bit Shift Register Look-Up-Table (LUT) with Negative-Edge Clock and Clock Enable
SRLC16	Primitive: 16-Bit Shift Register Look-Up Table (LUT) with Carry
SRLC16_1	Primitive: 16-Bit Shift Register Look-Up Table (LUT) with Carry and Negative-Edge Clock
SRLC16E	Primitive: 16-Bit Shift Register Look-Up Table (LUT) with Carry and Clock Enable
SRLC16E_1	Primitive: 16-Bit Shift Register Look-Up Table (LUT) with Carry, Negative-Edge Clock, and Clock Enable

## Shifter

Design Element	Description
<a href="#">BRLSHFT4</a>	Macro: 4-Bit Barrel Shifter
<a href="#">BRLSHFT8</a>	Macro: 8-Bit Barrel Shifter





# About Design Elements

This section describes the design elements that can be used with this architecture. The design elements are organized alphabetically.

The following information is provided for each design element, where applicable:

- Name of element
- Brief description
- Schematic symbol (if any)
- Logic Table (if any)
- Port Descriptions (if any)
- Usage
- Available Attributes (if any)
- For more information

You can find examples of VHDL and Verilog instantiation code in the ISE software (in the main menu, select **Edit > Language Templates** or in the *Libraries Guide for HDL Designs* for this architecture.

## ACC16

Macro: 16-Bit Loadable Cascadable Accumulator with Carry-In, Carry-Out, and Synchronous Reset

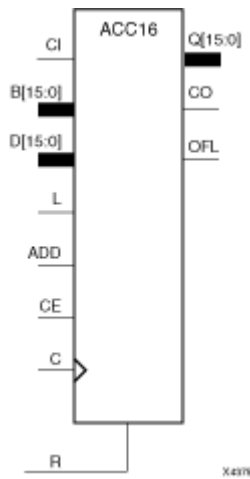

### Introduction

This design element can add or subtract a 16-bit unsigned-binary, respectively or twos-complement word to or from the contents of a 16-bit data register and store the results in the register. The register can be loaded with the 16-bit word.

When the load input (L) is High, CE is ignored and the data on the D inputs is loaded into the register during the Low-to-High clock (C) transition. ACC16 loads the data on inputs D15 – D0 into the 16-bit register.

This design element operates on either 16-bit unsigned binary numbers or 16-bit twos-complement numbers. If the inputs are interpreted as unsigned binary, the result can be interpreted as unsigned binary. If the inputs are interpreted as twos complement, the output can be interpreted as twos complement. The only functional difference between an unsigned binary operation and a twos-complement operation is how they determine when “overflow” occurs. Unsigned binary uses carry-out (CO), while twos complement uses OFL to determine when “overflow” occurs.

- For unsigned binary operation, ACC16 can represent numbers between 0 and 15, inclusive. In add mode, CO is active (High) when the sum exceeds the bounds of the adder/subtractor. In subtract mode, CO is an active-Low borrow-out and goes Low when the difference exceeds the bounds. The carry-out (CO) is not registered synchronously with the data outputs. CO always reflects the accumulation of the B inputs (B15 – B0 for ACC16). This allows the cascading of ACC16s by connecting CO of one stage to CI of the next stage. An unsigned binary “overflow” that is always active-High can be generated by gating the ADD signal and CO as follows:

$\text{unsigned overflow} = \text{CO XOR ADD}$

Ignore OFL in unsigned binary operation.

- For twos-complement operation, ACC16 represents numbers between -8 and +7, inclusive. If an addition or subtraction operation result exceeds this range, the OFL output goes High. The overflow (OFL) is not registered synchronously with the data outputs. OFL always reflects the accumulation of the B inputs (B15 – B0 for ACC16) and the contents of the register, which allows cascading of ACC4s by connecting OFL of one stage to CI of the next stage.

Ignore CO in twos-complement operation.

The synchronous reset (R) has priority over all other inputs, and when set to High, causes all outputs to go to logic level zero during the Low-to-High clock (C) transition. Clock (C) transitions are ignored when clock enable (CE) is Low.

This design element is asynchronously cleared, outputs Low, when power is applied. For FPGA devices, power-on conditions are simulated when global set/reset (GSR) is active. GSR defaults to active-High but can be inverted by adding an inverter in front of the GSR input of the appropriate `STARTUP_architecture` symbol.

## Logic Table

Input						Output
R	L	CE	ADD	D	C	Q
1	x	x	x	x	Rising	0
0	1	x	x	Dn	Rising	Dn
0	0	1	1	x	Rising	Q0+Bn+CI
0	0	1	0	x	Rising	Q0-Bn-CI
0	0	0	x	x	Rising	No Change

Q0: Previous value of Q  
 Bn: Value of Data input B  
 CI: Value of input CI

## Design Entry Method

This design element is only for use in schematics.

## For More Information

- See the [Spartan-3 User Guide](#).
- See the [Spartan-3 Data Sheets](#).

## ACC4

Macro: 4-Bit Loadable Cascadable Accumulator with Carry-In, Carry-Out, and Synchronous Reset



### Introduction

This design element can add or subtract a 4-bit unsigned-binary, respectively or twos-complement word to or from the contents of a 4-bit data register and store the results in the register. The register can be loaded with the 4-bit word.

When the load input (L) is High, CE is ignored and the data on the D inputs is loaded into the register during the Low-to-High clock (C) transition. ACC4 loads the data on inputs D3 – D0 into the 4-bit register.

This design element operates on either 4-bit unsigned binary numbers or 4-bit twos-complement numbers. If the inputs are interpreted as unsigned binary, the result can be interpreted as unsigned binary. If the inputs are interpreted as twos complement, the output can be interpreted as twos complement. The only functional difference between an unsigned binary operation and a twos-complement operation is how they determine when “overflow” occurs. Unsigned binary uses carry-out (CO), while twos complement uses OFL to determine when “overflow” occurs.

- For unsigned binary operation, ACC4 can represent numbers between 0 and 15, inclusive. In add mode, CO is active (High) when the sum exceeds the bounds of the adder/subtractor. In subtract mode, CO is an active-Low borrow-out and goes Low when the difference exceeds the bounds. The carry-out (CO) is not registered synchronously with the data outputs. CO always reflects the accumulation of the B inputs (B3 – B0 for ACC4). This allows the cascading of ACC4s by connecting CO of one stage to CI of the next stage. An unsigned binary “overflow” that is always active-High can be generated by gating the ADD signal and CO as follows:

unsigned overflow = CO XOR ADD

Ignore OFL in unsigned binary operation.

- For twos-complement operation, ACC4 represents numbers between -8 and +7, inclusive. If an addition or subtraction operation result exceeds this range, the OFL output goes High. The overflow (OFL) is not registered synchronously with the data outputs. OFL always reflects the accumulation of the B inputs (B3 – B0 for ACC4) and the contents of the register, which allows cascading of ACC4s by connecting OFL of one stage to CI of the next stage.

Ignore CO in twos-complement operation.

The synchronous reset (R) has priority over all other inputs, and when set to High, causes all outputs to go to logic level zero during the Low-to-High clock (C) transition. Clock (C) transitions are ignored when clock enable (CE) is Low.

This design element is asynchronously cleared, outputs Low, when power is applied. For FPGA devices, power-on conditions are simulated when global set/reset (GSR) is active. GSR defaults to active-High but can be inverted by adding an inverter in front of the GSR input of the appropriate `STARTUP_architecture` symbol.

## Logic Table

Input						Output
R	L	CE	ADD	D	C	Q
1	x	x	x	x	Rising	0
0	1	x	x	Dn	Rising	Dn
0	0	1	1	x	Rising	Q0+Bn+CI
0	0	1	0	x	Rising	Q0-Bn-CI
0	0	0	x	x	Rising	No Change

Q0: Previous value of Q  
 Bn: Value of Data input B  
 CI: Value of input CI

## Design Entry Method

This design element is only for use in schematics.

## For More Information

- See the [Spartan-3 User Guide](#).
- See the [Spartan-3 Data Sheets](#).

## ACC8

Macro: 8-Bit Loadable Cascadable Accumulator with Carry-In, Carry-Out, and Synchronous Reset

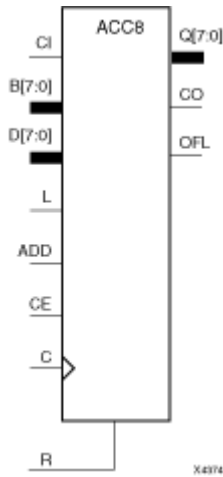

### Introduction

This design element can add or subtract a 8-bit unsigned-binary, respectively or twos-complement word to or from the contents of a 8-bit data register and store the results in the register. The register can be loaded with the 8-bit word.

When the load input (L) is High, CE is ignored and the data on the D inputs is loaded into the register during the Low-to-High clock (C) transition. ACC8 loads the data on inputs D7 – D0 into the 8-bit register.

This design element operates on either 8-bit unsigned binary numbers or 8-bit twos-complement numbers. If the inputs are interpreted as unsigned binary, the result can be interpreted as unsigned binary. If the inputs are interpreted as twos complement, the output can be interpreted as twos complement. The only functional difference between an unsigned binary operation and a twos-complement operation is how they determine when “overflow” occurs. Unsigned binary uses carry-out (CO), while twos complement uses OFL to determine when “overflow” occurs.

- For unsigned binary operation, ACC8 can represent numbers between 0 and 255, inclusive. In add mode, CO is active (High) when the sum exceeds the bounds of the adder/subtractor. In subtract mode, CO is an active-Low borrow-out and goes Low when the difference exceeds the bounds. The carry-out (CO) is not registered synchronously with the data outputs. CO always reflects the accumulation of the B inputs (B3 – B0 for ACC4). This allows the cascading of ACC8s by connecting CO of one stage to CI of the next stage. An unsigned binary “overflow” that is always active-High can be generated by gating the ADD signal and CO as follows:

$\text{unsigned overflow} = \text{CO XOR ADD}$

Ignore OFL in unsigned binary operation.

- For twos-complement operation, ACC8 represents numbers between -128 and +127, inclusive. If an addition or subtraction operation result exceeds this range, the OFL output goes High. The overflow (OFL) is not registered synchronously with the data outputs. OFL always reflects the accumulation of the B inputs (B3 – B0 for ACC8) and the contents of the register, which allows cascading of ACC8s by connecting OFL of one stage to CI of the next stage.

Ignore CO in twos-complement operation.

The synchronous reset (R) has priority over all other inputs, and when set to High, causes all outputs to go to logic level zero during the Low-to-High clock (C) transition. Clock (C) transitions are ignored when clock enable (CE) is Low.

This design element is asynchronously cleared, outputs Low, when power is applied. For FPGA devices, power-on conditions are simulated when global set/reset (GSR) is active. GSR defaults to active-High but can be inverted by adding an inverter in front of the GSR input of the appropriate `STARTUP_architecture` symbol.

## Logic Table

Input						Output
R	L	CE	ADD	D	C	Q
1	x	x	x	x	Rising	0
0	1	x	x	Dn	Rising	Dn
0	0	1	1	x	Rising	Q0+Bn+CI
0	0	1	0	x	Rising	Q0-Bn-CI
0	0	0	x	x	Rising	No Change

Q0: Previous value of Q  
 Bn: Value of Data input B  
 CI: Value of input CI

## Design Entry Method

This design element is only for use in schematics.

## For More Information

- See the [Spartan-3 User Guide](#).
- See the [Spartan-3 Data Sheets](#).

## ADD16

Macro: 16-Bit Cascadable Full Adder with Carry-In, Carry-Out, and Overflow

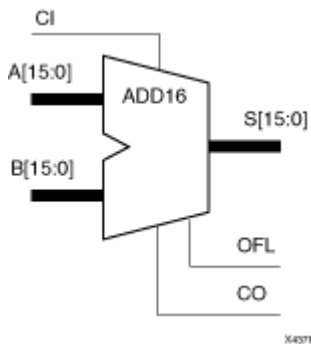

### Introduction

This design element adds two words and a carry-in (CI), producing a sum output and carry-out (CO) or overflow (OFL). The factors added are  $A_{15} - A_0$ ,  $B_{15} - B_0$  and CI, producing the sum output  $S_{15} - S_0$  and CO (or OFL).

### Logic Table

Input		Output
A	B	S
$A_n$	$B_n$	$A_n + B_n + CI$
CI: Value of input CI.		

### Unsigned Binary Versus Twos Complement

This design element can operate on either 16-bit unsigned binary numbers or 16-bit twos-complement numbers, respectively. If the inputs are interpreted as unsigned binary, the result can be interpreted as unsigned binary. If the inputs are interpreted as twos complement, the output can be interpreted as twos complement. The only functional difference between an unsigned binary operation and a twos-complement operation is the way they determine when “overflow” occurs. Unsigned binary uses CO, while twos-complement uses OFL to determine when “overflow” occurs. To interpret the inputs as unsigned binary, follow the CO output. To interpret the inputs as twos complement, follow the OFL output.

### Unsigned Binary Operation

For unsigned binary operation, this element represents numbers between 0 and 65535, inclusive. OFL is ignored in unsigned binary operation.

### Twos-Complement Operation

For twos-complement operation, this element can represent numbers between -32768 and +32767, inclusive. OFL is active (High) when the sum exceeds the bounds of the adder. CO is ignored in twos-complement operation.

### Design Entry Method

This design element is only for use in schematics.



---

## For More Information

- See the [Spartan-3 User Guide](#).
- See the [Spartan-3 Data Sheets](#).

## ADD4

Macro: 4-Bit Cascadable Full Adder with Carry-In, Carry-Out, and Overflow

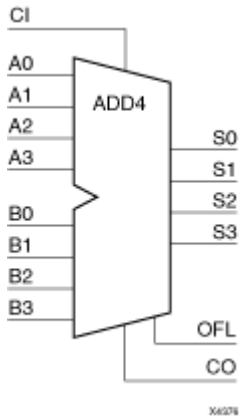

### Introduction

This design element adds two words and a carry-in (CI), producing a sum output and carry-out (CO) or overflow (OFL). The factors added are A3 – A0, B3 – B0, and CI producing the sum output S3 – S0 and CO (or OFL).

### Logic Table

Input		Output
A	B	S
A <sub>n</sub>	B <sub>n</sub>	A <sub>n</sub> +B <sub>n</sub> +CI
CI: Value of input CI.		

### Unsigned Binary Versus Twos Complement

This design element can operate on either 4-bit unsigned binary numbers or 4-bit twos-complement numbers, respectively. If the inputs are interpreted as unsigned binary, the result can be interpreted as unsigned binary. If the inputs are interpreted as twos complement, the output can be interpreted as twos complement. The only functional difference between an unsigned binary operation and a twos-complement operation is the way they determine when “overflow” occurs. Unsigned binary uses CO, while twos-complement uses OFL to determine when “overflow” occurs. To interpret the inputs as unsigned binary, follow the CO output. To interpret the inputs as twos complement, follow the OFL output.

### Unsigned Binary Operation

For unsigned binary operation, this element represents numbers from 0 to 15, inclusive. OFL is ignored in unsigned binary operation.

### Twos-Complement Operation

For twos-complement operation, this element can represent numbers between -8 and +7, inclusive. OFL is active (High) when the sum exceeds the bounds of the adder. CO is ignored in twos-complement operation.

### Design Entry Method

This design element is only for use in schematics.

---

## For More Information

- See the [Spartan-3 User Guide](#).
- See the [Spartan-3 Data Sheets](#).

## ADD8

Macro: 8-Bit Cascadable Full Adder with Carry-In, Carry-Out, and Overflow

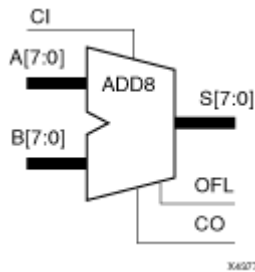

### Introduction

This design element adds two words and a carry-in (CI), producing a sum output and carry-out (CO) or overflow (OFL). The factors added are  $A_7 - A_0$ ,  $B_7 - B_0$ , and CI, producing the sum output  $S_7 - S_0$  and CO (or OFL).

### Logic Table

Input		Output
A	B	S
$A_n$	$B_n$	$A_n + B_n + CI$
CI: Value of input CI.		

### Unsigned Binary Versus Twos Complement

This design element can operate on either 8-bit unsigned binary numbers or 8-bit twos-complement numbers, respectively. If the inputs are interpreted as unsigned binary, the result can be interpreted as unsigned binary. If the inputs are interpreted as twos complement, the output can be interpreted as twos complement. The only functional difference between an unsigned binary operation and a twos-complement operation is the way they determine when “overflow” occurs. Unsigned binary uses CO, while twos-complement uses OFL to determine when “overflow” occurs. To interpret the inputs as unsigned binary, follow the CO output. To interpret the inputs as twos complement, follow the OFL output.

### Unsigned Binary Operation

For unsigned binary operation, this element represents numbers between 0 and 255, inclusive. OFL is ignored in unsigned binary operation.

### Twos-Complement Operation

For twos-complement operation, this element can represent numbers between -128 and +127, inclusive. OFL is active (High) when the sum exceeds the bounds of the adder. CO is ignored in twos-complement operation.

### Design Entry Method

This design element is only for use in schematics.

### For More Information

- See the [Spartan-3 User Guide](#).
- See the [Spartan-3 Data Sheets](#).

## ADSU16

Macro: 16-Bit Cascadable Adder/Subtractor with Carry-In, Carry-Out, and Overflow

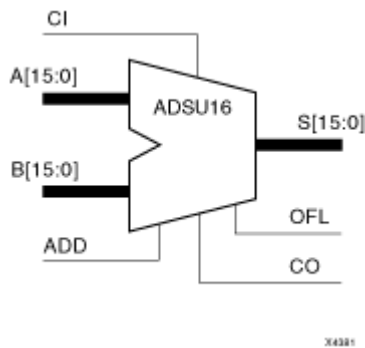

### Introduction

When the ADD input is High, ADSU16 adds two 16-bit words ( $A_{15} - A_0$  and  $B_{15} - B_0$ ) and a CI are added, producing a 16-bit sum output ( $S_{15} - S_0$ ) and CO or OFL. ADSU4 adds two 4-bit words ( $A_3 - A_0$  and  $B_3 - B_0$ ) and a CI, producing a 4-bit sum output ( $S_3 - S_0$ ) and CO or OFL. ADSU8 adds two 8-bit words ( $A_7 - A_0$  and  $B_7 - B_0$ ) and a CI producing, an 8-bit sum output ( $S_7 - S_0$ ) and CO or OFL. ADSU16 adds two 16-bit words ( $A_{15} - A_0$  and  $B_{15} - B_0$ ) and a CI, producing a 16-bit sum output ( $S_{15} - S_0$ ) and CO or OFL.

When the ADD input is Low, this element subtracts  $B_z - B_0$  from  $A_z - A_0$ , producing a difference output and CO or OFL. It subtracts  $B_3 - B_0$  from  $A_3 - A_0$ , producing a 4-bit difference ( $S_3 - S_0$ ) and CO or OFL.

In add mode, CO and CI are active-High. In subtract mode, CO and CI are active-Low. OFL is active-High in add and subtract modes.

### Logic Table

Input			Output
ADD	A	B	S
1	$A_n$	$B_n$	$A_n + B_n + CI^*$
0	$A_n$	$B_n$	$A_n - B_n - CI^*$
CI*: ADD = 0, CI, CO active LOW			
CI*: ADD = 1, CI, CO active HIGH			

#### Unsigned Binary Versus Twos Complement

This design element can operate on either 16-bit unsigned binary numbers or 16-bit twos-complement numbers. If the inputs are interpreted as unsigned binary, the result can be interpreted as unsigned binary. If the inputs are interpreted as twos complement, the output can be interpreted as twos complement. The only functional difference between an unsigned binary operation and a twos-complement operation is the way they determine when "overflow" occurs. Unsigned binary uses CO, while twos complement uses OFL to determine when "overflow" occurs.

With adder/subtractors, either unsigned binary or twos-complement operations cause an overflow. If the result crosses the overflow boundary, an overflow is generated. Similarly, when the result crosses the carry-out boundary, a carry-out is generated.

#### Unsigned Binary Operation

For unsigned binary operation, this element can represent numbers between 0 and 65535, inclusive. In add mode, CO is active (High) when the sum exceeds the bounds of the adder/subtractor. In subtract mode, CO is an active-Low borrow-out and goes Low when the difference exceeds the bounds.

An unsigned binary “overflow” that is always active-High can be generated by gating the ADD signal and CO as follows:

$\text{unsigned overflow} = \text{CO XOR ADD}$

OFL is ignored in unsigned binary operation.

#### *Twos-Complement Operation*

For twos-complement operation, this element can represent numbers between -32768 and +32767, inclusive.

If an addition or subtraction operation result exceeds this range, the OFL output goes High. CO is ignored in twos-complement operation.

## Design Entry Method

This design element is only for use in schematics.

## For More Information

- See the [Spartan-3 User Guide](#).
- See the [Spartan-3 Data Sheets](#).

## ADSU4

Macro: 4-Bit Cascadable Adder/Subtractor with Carry-In, Carry-Out, and Overflow

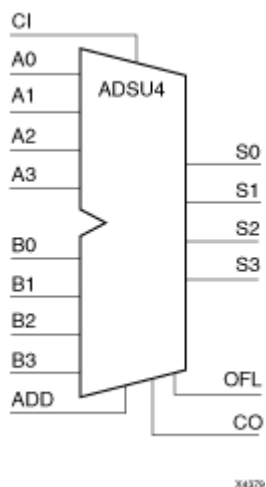

### Introduction

When the ADD input is High, ADSU4 adds two 4-bit words ( $A_3 - A_0$  and  $B_3 - B_0$ ) and a CI are added, producing a 4-bit sum output ( $S_3 - S_0$ ) and CO or OFL. For this element, two 4-bit words ( $A_3 - A_0$  and  $B_3 - B_0$ ) and a CI are added, producing a 4-bit sum output ( $S_3 - S_0$ ) and CO or OFL.

When the ADD input is Low, this element subtracts  $B_3 - B_0$  from  $A_3 - A_0$ , producing a 4-bit difference ( $S_3 - S_0$ ) and CO or OFL.

In add mode, CO and CI are active-High. In subtract mode, CO and CI are active-Low. OFL is active-High in add and subtract modes.

### Logic Table

Input			Output
ADD	A	B	S
1	$A_n$	$B_n$	$A_n + B_n + CI^*$
0	$A_n$	$B_n$	$A_n - B_n - CI^*$
CI*: ADD = 0, CI, CO active LOW			
CI*: ADD = 1, CI, CO active HIGH			

#### *Unsigned Binary Versus Twos Complement*

This design element can operate on either 4-bit unsigned binary numbers or 4-bit twos-complement numbers. If the inputs are interpreted as unsigned binary, the result can be interpreted as unsigned binary. If the inputs are interpreted as twos complement, the output can be interpreted as twos complement. The only functional difference between an unsigned binary operation and a twos-complement operation is the way they determine when "overflow" occurs. Unsigned binary uses CO, while twos complement uses OFL to determine when "overflow" occurs.

With adder/subtractors, either unsigned binary or twos-complement operations cause an overflow. If the result crosses the overflow boundary, an overflow is generated. Similarly, when the result crosses the carry-out boundary, a carry-out is generated.

#### *Unsigned Binary Operation*

For unsigned binary operation, ADSU4 can represent numbers between 0 and 15, inclusive. In add mode, CO is active (High) when the sum exceeds the bounds of the adder/subtractor. In subtract mode, CO is an active-Low borrow-out and goes Low when the difference exceeds the bounds.

An unsigned binary “overflow” that is always active-High can be generated by gating the ADD signal and CO as follows:

`unsigned overflow = CO XOR ADD`

OFL is ignored in unsigned binary operation.

#### *Twos-Complement Operation*

For twos-complement operation, this element can represent numbers between -8 and +7, inclusive.

If an addition or subtraction operation result exceeds this range, the OFL output goes High. CO is ignored in twos-complement operation.

## Design Entry Method

This design element is only for use in schematics.

## For More Information

- See the [Spartan-3 User Guide](#).
- See the [Spartan-3 Data Sheets](#).



## ADSU8

Macro: 8-Bit Cascadable Adder/Subtractor with Carry-In, Carry-Out, and Overflow

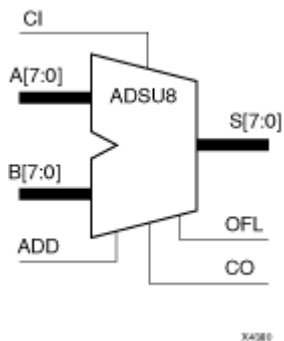

### Introduction

When the ADD input is High, ADSU8 adds two 8-bit words ( $A_7 - A_0$  and  $B_7 - B_0$ ) and a CI are added, producing an 8-bit sum output ( $S_7 - S_0$ ) and CO or OFL. For this element, two 8-bit words ( $A_7 - A_0$  and  $B_7 - B_0$ ) and a CI producing, an 8-bit sum output ( $S_7 - S_0$ ) and CO or OFL.

When the ADD input is Low, this element subtracts  $B_7 - B_0$  from  $A_7 - A_0$ , producing an 8-bit difference ( $S_7 - S_0$ ) and CO or OFL.

In add mode, CO and CI are active-High. In subtract mode, CO and CI are active-Low. OFL is active-High in add and subtract modes.

### Logic Table

Input			Output
ADD	A	B	S
1	$A_n$	$B_n$	$A_n + B_n + CI^*$
0	$A_n$	$B_n$	$A_n - B_n - CI^*$
CI*: ADD = 0, CI, CO active LOW			
CI*: ADD = 1, CI, CO active HIGH			

#### Unsigned Binary Versus Twos Complement

This design element can operate on either 8-bit unsigned binary numbers or 8-bit twos-complement numbers. If the inputs are interpreted as unsigned binary, the result can be interpreted as unsigned binary. If the inputs are interpreted as twos complement, the output can be interpreted as twos complement. The only functional difference between an unsigned binary operation and a twos-complement operation is the way they determine when "overflow" occurs. Unsigned binary uses CO, while twos complement uses OFL to determine when "overflow" occurs.

With adder/subtractors, either unsigned binary or twos-complement operations cause an overflow. If the result crosses the overflow boundary, an overflow is generated. Similarly, when the result crosses the carry-out boundary, a carry-out is generated.

#### Unsigned Binary Operation

For unsigned binary operation, this element can represent numbers between 0 and 255, inclusive. In add mode, CO is active (High) when the sum exceeds the bounds of the adder/subtractor. In subtract mode, CO is an active-Low borrow-out and goes Low when the difference exceeds the bounds.

An unsigned binary "overflow" that is always active-High can be generated by gating the ADD signal and CO as follows:

$$\text{unsigned overflow} = \text{CO XOR ADD}$$

OFL is ignored in unsigned binary operation.

#### *Twos-Complement Operation*

For twos-complement operation, this element can represent numbers between -128 and +127, inclusive.

If an addition or subtraction operation result exceeds this range, the OFL output goes High. CO is ignored in twos-complement operation.

### **Design Entry Method**

This design element is only for use in schematics.

### **For More Information**

- See the [Spartan-3 User Guide](#).
- See the [Spartan-3 Data Sheets](#).

## AND12

Macro: 12- Input AND Gate with Non-Inverted Inputs

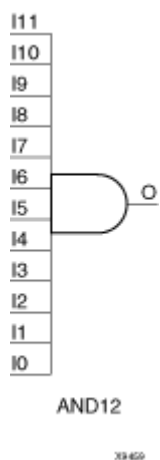

### Introduction

AND functions of up to five inputs are available in any combination of inverting and non-inverting inputs. AND functions of six to nine inputs, 12 inputs, and 16 inputs are available with noninverting inputs. To make some or all inputs inverting, use external inverters. Because each input uses a CLB resource, replace functions with unused inputs with functions having the appropriate number of inputs.

### Design Entry Method

This design element is only for use in schematics.

### For More Information

- See the [Spartan-3 User Guide](#).
- See the [Spartan-3 Data Sheets](#).

## AND16

Macro: 16- Input AND Gate with Non-Inverted Inputs

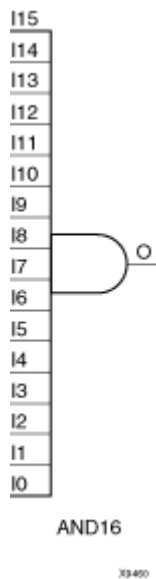

### Introduction

AND functions of up to five inputs are available in any combination of inverting and non-inverting inputs. AND functions of six to nine inputs, 12 inputs, and 16 inputs are available with noninverting inputs. To make some or all inputs inverting, use external inverters. Because each input uses a CLB resource, replace functions with unused inputs with functions having the appropriate number of inputs.

### Design Entry Method

This design element is only for use in schematics.

### For More Information

- See the [Spartan-3 User Guide](#).
- See the [Spartan-3 Data Sheets](#).

## AND2

Primitive: 2-Input AND Gate with Non-Inverted Inputs

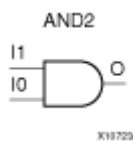

### Introduction

AND functions of up to five inputs are available in any combination of inverting and non-inverting inputs. AND functions of six to nine inputs, 12 inputs, and 16 inputs are available with noninverting inputs. To make some or all inputs inverting, use external inverters. Because each input uses a CLB resource, replace functions with unused inputs with functions having the appropriate number of inputs.

### Design Entry Method

This design element is only for use in schematics.

### For More Information

- See the [Spartan-3 User Guide](#).
- See the [Spartan-3 Data Sheets](#).

## AND2B1

Primitive: 2-Input AND Gate with 1 Inverted and 1 Non-Inverted Inputs



### Introduction

AND functions of up to five inputs are available in any combination of inverting and non-inverting inputs. AND functions of six to nine inputs, 12 inputs, and 16 inputs are available with noninverting inputs. To make some or all inputs inverting, use external inverters. Because each input uses a CLB resource, replace functions with unused inputs with functions having the appropriate number of inputs.

### Design Entry Method

This design element is only for use in schematics.

### For More Information

- See the [Spartan-3 User Guide](#).
- See the [Spartan-3 Data Sheets](#).

## AND2B2

Primitive: 2-Input AND Gate with Inverted Inputs

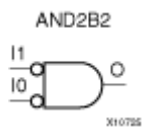

### Introduction

AND functions of up to five inputs are available in any combination of inverting and non-inverting inputs. AND functions of six to nine inputs, 12 inputs, and 16 inputs are available with noninverting inputs. To make some or all inputs inverting, use external inverters. Because each input uses a CLB resource, replace functions with unused inputs with functions having the appropriate number of inputs.

### Design Entry Method

This design element is only for use in schematics.

### For More Information

- See the [Spartan-3 User Guide](#).
- See the [Spartan-3 Data Sheets](#).

## AND3

Primitive: 3-Input AND Gate with Non-Inverted Inputs



### Introduction

AND functions of up to five inputs are available in any combination of inverting and non-inverting inputs. AND functions of six to nine inputs, 12 inputs, and 16 inputs are available with noninverting inputs. To make some or all inputs inverting, use external inverters. Because each input uses a CLB resource, replace functions with unused inputs with functions having the appropriate number of inputs.

### Design Entry Method

This design element is only for use in schematics.

### For More Information

- See the [Spartan-3 User Guide](#).
- See the [Spartan-3 Data Sheets](#).



## AND3B1

Primitive: 3-Input AND Gate with 1 Inverted and 2 Non-Inverted Inputs

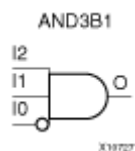

### Introduction

AND functions of up to five inputs are available in any combination of inverting and non-inverting inputs. AND functions of six to nine inputs, 12 inputs, and 16 inputs are available with noninverting inputs. To make some or all inputs inverting, use external inverters. Because each input uses a CLB resource, replace functions with unused inputs with functions having the appropriate number of inputs.

### Design Entry Method

This design element is only for use in schematics.

### For More Information

- See the [Spartan-3 User Guide](#).
- See the [Spartan-3 Data Sheets](#).

## AND3B2

Primitive: 3-Input AND Gate with 2 Inverted and 1 Non-Inverted Inputs

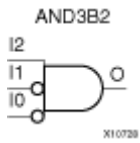

### Introduction

AND functions of up to five inputs are available in any combination of inverting and non-inverting inputs. AND functions of six to nine inputs, 12 inputs, and 16 inputs are available with noninverting inputs. To make some or all inputs inverting, use external inverters. Because each input uses a CLB resource, replace functions with unused inputs with functions having the appropriate number of inputs.

### Design Entry Method

This design element is only for use in schematics.

### For More Information

- See the [Spartan-3 User Guide](#).
- See the [Spartan-3 Data Sheets](#).

## AND3B3

Primitive: 3-Input AND Gate with Inverted Inputs

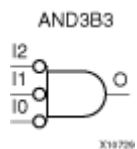

### Introduction

AND functions of up to five inputs are available in any combination of inverting and non-inverting inputs. AND functions of six to nine inputs, 12 inputs, and 16 inputs are available with noninverting inputs. To make some or all inputs inverting, use external inverters. Because each input uses a CLB resource, replace functions with unused inputs with functions having the appropriate number of inputs.

### Design Entry Method

This design element is only for use in schematics.

### For More Information

- See the [Spartan-3 User Guide](#).
- See the [Spartan-3 Data Sheets](#).

## AND4

Primitive: 4-Input AND Gate with Non-Inverted Inputs

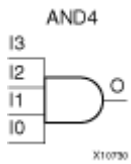

### Introduction

AND functions of up to five inputs are available in any combination of inverting and non-inverting inputs. AND functions of six to nine inputs, 12 inputs, and 16 inputs are available with noninverting inputs. To make some or all inputs inverting, use external inverters. Because each input uses a CLB resource, replace functions with unused inputs with functions having the appropriate number of inputs.

### Design Entry Method

This design element is only for use in schematics.

### For More Information

- See the [Spartan-3 User Guide](#).
- See the [Spartan-3 Data Sheets](#).

## AND4B1

Primitive: 4-Input AND Gate with 1 Inverted and 3 Non-Inverted Inputs

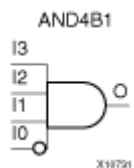

### Introduction

AND functions of up to five inputs are available in any combination of inverting and non-inverting inputs. AND functions of six to nine inputs, 12 inputs, and 16 inputs are available with noninverting inputs. To make some or all inputs inverting, use external inverters. Because each input uses a CLB resource, replace functions with unused inputs with functions having the appropriate number of inputs.

### Design Entry Method

This design element is only for use in schematics.

### For More Information

- See the [Spartan-3 User Guide](#).
- See the [Spartan-3 Data Sheets](#).

## AND4B2

Primitive: 4-Input AND Gate with 2 Inverted and 2 Non-Inverted Inputs

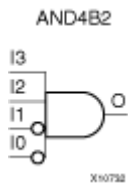

### Introduction

AND functions of up to five inputs are available in any combination of inverting and non-inverting inputs. AND functions of six to nine inputs, 12 inputs, and 16 inputs are available with noninverting inputs. To make some or all inputs inverting, use external inverters. Because each input uses a CLB resource, replace functions with unused inputs with functions having the appropriate number of inputs.

### Design Entry Method

This design element is only for use in schematics.

### For More Information

- See the [Spartan-3 User Guide](#).
- See the [Spartan-3 Data Sheets](#).

## AND4B3

Primitive: 4-Input AND Gate with 3 Inverted and 1 Non-Inverted Inputs

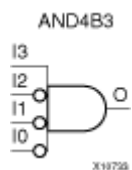

### Introduction

AND functions of up to five inputs are available in any combination of inverting and non-inverting inputs. AND functions of six to nine inputs, 12 inputs, and 16 inputs are available with noninverting inputs. To make some or all inputs inverting, use external inverters. Because each input uses a CLB resource, replace functions with unused inputs with functions having the appropriate number of inputs.

### Design Entry Method

This design element is only for use in schematics.

### For More Information

- See the [Spartan-3 User Guide](#).
- See the [Spartan-3 Data Sheets](#).

## AND4B4

Primitive: 4-Input AND Gate with Inverted Inputs

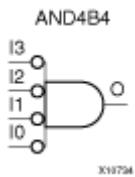

### Introduction

AND functions of up to five inputs are available in any combination of inverting and non-inverting inputs. AND functions of six to nine inputs, 12 inputs, and 16 inputs are available with noninverting inputs. To make some or all inputs inverting, use external inverters. Because each input uses a CLB resource, replace functions with unused inputs with functions having the appropriate number of inputs.

### Design Entry Method

This design element is only for use in schematics.

### For More Information

- See the [Spartan-3 User Guide](#).
- See the [Spartan-3 Data Sheets](#).



## AND5

Primitive: 5-Input AND Gate with Non-Inverted Inputs

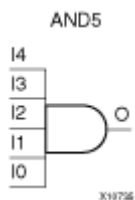

### Introduction

AND functions of up to five inputs are available in any combination of inverting and non-inverting inputs. AND functions of six to nine inputs, 12 inputs, and 16 inputs are available with noninverting inputs. To make some or all inputs inverting, use external inverters. Because each input uses a CLB resource, replace functions with unused inputs with functions having the appropriate number of inputs.

### Design Entry Method

This design element is only for use in schematics.

### For More Information

- See the [Spartan-3 User Guide](#).
- See the [Spartan-3 Data Sheets](#).

## AND5B1

Primitive: 5-Input AND Gate with 1 Inverted and 4 Non-Inverted Inputs

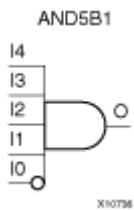

### Introduction

AND functions of up to five inputs are available in any combination of inverting and non-inverting inputs. AND functions of six to nine inputs, 12 inputs, and 16 inputs are available with noninverting inputs. To make some or all inputs inverting, use external inverters. Because each input uses a CLB resource, replace functions with unused inputs with functions having the appropriate number of inputs.

### Design Entry Method

This design element is only for use in schematics.

### For More Information

- See the [Spartan-3 User Guide](#).
- See the [Spartan-3 Data Sheets](#).

## AND5B2

Primitive: 5-Input AND Gate with 2 Inverted and 3 Non-Inverted Inputs

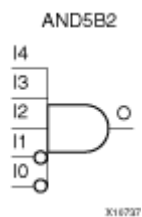

### Introduction

AND functions of up to five inputs are available in any combination of inverting and non-inverting inputs. AND functions of six to nine inputs, 12 inputs, and 16 inputs are available with noninverting inputs. To make some or all inputs inverting, use external inverters. Because each input uses a CLB resource, replace functions with unused inputs with functions having the appropriate number of inputs.

### Design Entry Method

This design element is only for use in schematics.

### Available Attributes

### For More Information

- See the [Spartan-3 User Guide](#).
- See the [Spartan-3 Data Sheets](#).

## AND5B3

Primitive: 5-Input AND Gate with 3 Inverted and 2 Non-Inverted Inputs

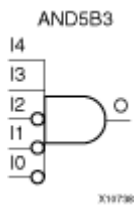

### Introduction

AND functions of up to five inputs are available in any combination of inverting and non-inverting inputs. AND functions of six to nine inputs, 12 inputs, and 16 inputs are available with noninverting inputs. To make some or all inputs inverting, use external inverters. Because each input uses a CLB resource, replace functions with unused inputs with functions having the appropriate number of inputs.

### Design Entry Method

This design element is only for use in schematics.

### For More Information

- See the [Spartan-3 User Guide](#).
- See the [Spartan-3 Data Sheets](#).

## AND5B4

Primitive: 5-Input AND Gate with 4 Inverted and 1 Non-Inverted Inputs

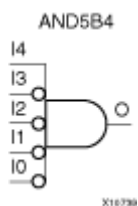

### Introduction

AND functions of up to five inputs are available in any combination of inverting and non-inverting inputs. AND functions of six to nine inputs, 12 inputs, and 16 inputs are available with noninverting inputs. To make some or all inputs inverting, use external inverters. Because each input uses a CLB resource, replace functions with unused inputs with functions having the appropriate number of inputs.

### Design Entry Method

This design element is only for use in schematics.

### For More Information

- See the [Spartan-3 User Guide](#).
- See the [Spartan-3 Data Sheets](#).

## AND5B5

Primitive: 5-Input AND Gate with Inverted Inputs

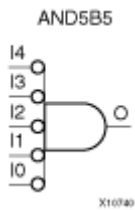

### Introduction

AND functions of up to five inputs are available in any combination of inverting and non-inverting inputs. AND functions of six to nine inputs, 12 inputs, and 16 inputs are available with noninverting inputs. To make some or all inputs inverting, use external inverters. Because each input uses a CLB resource, replace functions with unused inputs with functions having the appropriate number of inputs.

### Design Entry Method

This design element is only for use in schematics.

### For More Information

- See the [Spartan-3 User Guide](#).
- See the [Spartan-3 Data Sheets](#).

## AND6

Macro: 6-Input AND Gate with Non-Inverted Inputs

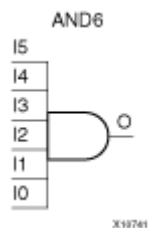

### Introduction

AND functions of up to five inputs are available in any combination of inverting and non-inverting inputs. AND functions of six to nine inputs, 12 inputs, and 16 inputs are available with noninverting inputs. To make some or all inputs inverting, use external inverters. Because each input uses a CLB resource, replace functions with unused inputs with functions having the appropriate number of inputs.

### Design Entry Method

This design element is only for use in schematics.

### For More Information

- See the [Spartan-3 User Guide](#).
- See the [Spartan-3 Data Sheets](#).

## AND7

Macro: 7-Input AND Gate with Non-Inverted Inputs

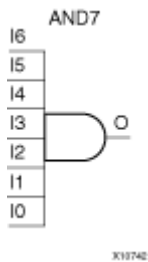

### Introduction

AND functions of up to five inputs are available in any combination of inverting and non-inverting inputs. AND functions of six to nine inputs, 12 inputs, and 16 inputs are available with noninverting inputs. To make some or all inputs inverting, use external inverters. Because each input uses a CLB resource, replace functions with unused inputs with functions having the appropriate number of inputs.

### Design Entry Method

This design element is only for use in schematics.

### For More Information

- See the [Spartan-3 User Guide](#).
- See the [Spartan-3 Data Sheets](#).



## AND8

Macro: 8-Input AND Gate with Non-Inverted Inputs

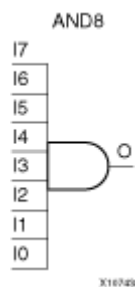

### Introduction

AND functions of up to five inputs are available in any combination of inverting and non-inverting inputs. AND functions of six to nine inputs, 12 inputs, and 16 inputs are available with noninverting inputs. To make some or all inputs inverting, use external inverters. Because each input uses a CLB resource, replace functions with unused inputs with functions having the appropriate number of inputs.

### Design Entry Method

This design element is only for use in schematics.

### For More Information

- See the [Spartan-3 User Guide](#).
- See the [Spartan-3 Data Sheets](#).

## AND9

Macro: 9-Input AND Gate with Non-Inverted Inputs

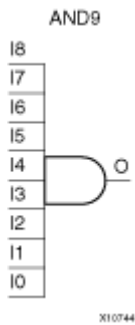

### Introduction

AND functions of up to five inputs are available in any combination of inverting and non-inverting inputs. AND functions of six to nine inputs, 12 inputs, and 16 inputs are available with noninverting inputs. To make some or all inputs inverting, use external inverters. Because each input uses a CLB resource, replace functions with unused inputs with functions having the appropriate number of inputs.

### Design Entry Method

This design element is only for use in schematics.

### For More Information

- See the [Spartan-3 User Guide](#).
- See the [Spartan-3 Data Sheets](#).

# BRLSHFT4

Macro: 4-Bit Barrel Shifter

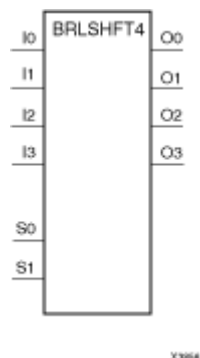

## Introduction

This design element is a 4-bit barrel shifter that can rotate four inputs (I3 – I0) up to four places. The control inputs (S1 and S0) determine the number of positions, from one to four, that the data is rotated. The four outputs (O3 – O0) reflect the shifted data inputs.

## Logic Table

Inputs						Outputs			
S1	S0	I0	I1	I2	I3	O0	O1	O2	O3
0	0	a	b	c	d	a	b	c	d
0	1	a	b	c	d	b	c	d	a
1	0	a	b	c	d	c	d	a	b
1	1	a	b	c	d	d	a	b	c

## Design Entry Method

This design element is only for use in schematics.

## For More Information

- See the [Spartan-3 User Guide](#).
- See the [Spartan-3 Data Sheets](#).

## BRLSHFT8

Macro: 8-Bit Barrel Shifter

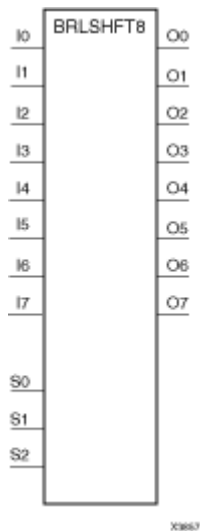

### Introduction

This design element is an 8-bit barrel shifter, can rotate the eight inputs (I7 – I0) up to eight places. The control inputs (S2 – S0) determine the number of positions, from one to eight, that the data is rotated. The eight outputs (O7 – O0) reflect the shifted data inputs.

### Logic Table

Inputs											Outputs							
S2	S1	S0	I0	I1	I2	I3	I4	I5	I6	I7	O0	O1	O2	O3	O4	O5	O6	O7
0	0	0	a	b	c	d	e	f	g	h	a	b	c	d	e	f	g	h
0	0	1	a	b	c	d	e	f	g	h	b	c	d	e	f	g	h	a
0	1	0	a	b	c	d	e	f	g	h	c	d	e	f	g	h	a	b
0	1	1	a	b	c	d	e	f	g	h	d	e	f	g	h	a	b	c
1	0	0	a	b	c	d	e	f	g	h	e	f	g	h	a	b	c	d
1	0	1	a	b	c	d	e	f	g	h	f	g	h	a	b	c	d	e
1	1	0	a	b	c	d	e	f	g	h	g	h	a	b	c	d	e	f
1	1	1	a	b	c	d	e	f	g	h	h	a	b	c	d	e	f	g

### Design Entry Method

This design element is only for use in schematics.

### For More Information

- See the [Spartan-3 User Guide](#).
- See the [Spartan-3 Data Sheets](#).

## BSCAN\_SPARTAN3

Primitive: Spartan-3 Register State Capture for Bitstream Readback

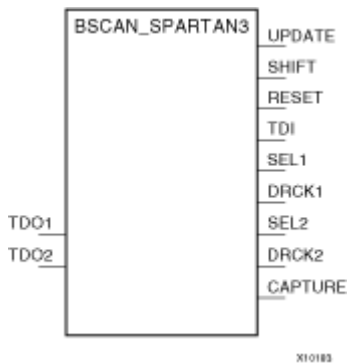

### Introduction

This design element provides access to the BSCAN sites on a Spartan-3 device. It is used to create internal boundary scan chains. The 4-pin JTAG interface (TDI, TDO, TCK, and TMS) are dedicated pins in Spartan-3. To use normal JTAG for boundary scan purposes, just hook up the JTAG pins to the port and go. The pins on the BSCAN\_SPARTAN3 symbol do not need to be connected, unless those special functions are needed to drive an internal scan chain.

A signal on the TDO1 input is passed to the external TDO output when the USER1 instruction is executed; the SEL1 output goes High to indicate that the USER1 instruction is active. The DRCK1 output provides USER1 access to the data register clock (generated by the TAP controller). The TDO2 and SEL2 pins perform a similar function for the USER2 instruction and the DRCK2 output provides USER2 access to the data register clock (generated by the TAP controller). The RESET, UPDATE, SHIFT, and CAPTURE pins represent the decoding of the corresponding state of the boundary scan internal state machine. The TDI pin provides access to the TDI signal of the JTAG port in order to shift data into an internal scan chain.

**Note** For specific information on boundary scan for an architecture, see *The Programmable Logic Data Sheets*

### Design Entry Method

This design element can be used in schematics.

### For More Information

- See the [Spartan-3 User Guide](#).
- See the [Spartan-3 Data Sheets](#).

## BUF

Primitive: General Purpose Buffer

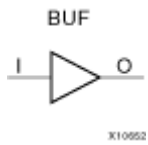

### Introduction

This is a general-purpose, non-inverting buffer.

This element is not necessary and is removed by the partitioning software (MAP).

### Design Entry Method

This design element is only for use in schematics.

### For More Information

- See the [Spartan-3 User Guide](#).
- See the [Spartan-3 Data Sheets](#).

## BUFCF

Primitive: Fast Connect Buffer

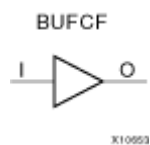

### Introduction

This design element is a single fast connect buffer used to connect the outputs of the LUTs and some dedicated logic directly to the input of another LUT. Using this buffer implies CLB packing. No more than four LUTs may be connected together as a group.

### Design Entry Method

This design element can be used in schematics.

### For More Information

- See the [Spartan-3 User Guide](#).
- See the [Spartan-3 Data Sheets](#).

## BUFG

Primitive: Global Clock Buffer

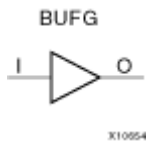

### Introduction

This design element is a high-fanout buffer that connects signals to the global routing resources for low skew distribution of the signal. BUFs are typically used on clock nets as well other high fanout nets like sets/resets and clock enables.

### Design Entry Method

This design element can be used in schematics.

### For More Information

- See the [Spartan-3 User Guide](#).
- See the [Spartan-3 Data Sheets](#).



## BUFGCE

Primitive: Global Clock Buffer with Clock Enable

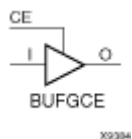

### Introduction

This design element is a global clock buffer with a single gated input. Its O output is "0" when clock enable (CE) is Low (inactive). When clock enable (CE) is High, the I input is transferred to the O output.

### Logic Table

Inputs		Outputs
I	CE	O
X	0	0
I	1	I

### Design Entry Method

This design element can be used in schematics.

### For More Information

- See the [Spartan-3 User Guide](#).
- See the [Spartan-3 Data Sheets](#).

## BUFGCE\_1

Primitive: Global Clock Buffer with Clock Enable and Output State 1



### Introduction

This design element is a multiplexed global clock buffer with a single gated input. Its O output is High (1) when clock enable (CE) is Low (inactive). When clock enable (CE) is High, the I input is transferred to the O output.

### Logic Table

Inputs		Outputs
I	CE	O
X	0	1
I	1	I

### Design Entry Method

This design element can be used in schematics.

### For More Information

- See the [Spartan-3 User Guide](#).
- See the [Spartan-3 Data Sheets](#).

## BUFGMUX

Primitive: Global Clock MUX Buffer



### Introduction

BUFGMUX is a multiplexed global clock buffer, based off of the BUFGCTRL, that can select between two input clocks: I0 and I1. When the select input (S) is Low, the signal on I0 is selected for output (O). When the select input (S) is High, the signal on I1 is selected for output.

BUFGMUX and BUFGMUX\_1 are distinguished by the state the output assumes when that output switches between clocks in response to a change in its select input. BUFGMUX assumes output state 0 and BUFGMUX\_1 assumes output state 1.

**Note** BUFGMUX guarantees that when S is toggled, the state of the output remains in the inactive state until the next active clock edge (either I0 or I1) occurs.

### Logic Table

Inputs			Outputs
I0	I1	S	O
I0	X	0	I0
X	I1	1	I1
X	X	↑	0
X	X	↓	0

### Design Entry Method

This design element can be used in schematics.

### For More Information

- See the [Spartan-3 User Guide](#).
- See the [Spartan-3 Data Sheets](#).

## BUFGMUX\_1

Primitive: Global Clock MUX Buffer with Output State 1



### Introduction

This design element is a multiplexed global clock buffer that can select between two input clocks: I0 and I1. When the select input (S) is Low, the signal on I0 is selected for output (O). When the select input (S) is High, the signal on I1 is selected for output.

This design element is distinguished from BUFGMUX by the state the output assumes when that output switches between clocks in response to a change in its select input. BUFGMUX assumes output state 0 and BUFGMUX\_1 assumes output state 1.

### Logic Table

Inputs			Outputs
I0	I1	S	O
I0	X	0	I0
X	I1	1	I1
X	X	↑	1
X	X	↓	1

### Design Entry Method

This design element can be used in schematics.

### For More Information

- See the [Spartan-3 User Guide](#).
- See the [Spartan-3 Data Sheets](#).

## BUFGP

Primitive: Primary Global Buffer for Driving Clocks or Longlines (Four per PLD Device)



### Introduction

This design element is a primary global buffer that is used to distribute high fan-out clock or control signals throughout PLD devices. In Spartan-II, Spartan-IIe, Spartan-3, Virtex, Virtex-E, Virtex-II, Virtex-II Pro, and Virtex-II Pro X, this element is equivalent to an IBUFG driving a BUFG.

In working with CPLDs, this element is treated like BUFG. It provides direct access to Configurable Logic Block (CLB) and Input Output Block (IOB) clock pins and limited access to other CLB inputs. The input to a BUFGP comes only from a dedicated IOB. Because of its structure, this element can always access a clock pin directly. However, it can access only one of the F3, G1, C3, or C1 pins, depending on the corner in which the BUFGP is placed. When the required pin cannot be accessed directly from the vertical line, PAR feeds the signal through another CLB and uses general purpose routing to access the load pin.

### Design Entry Method

#### For More Information

- See the [Spartan-3 User Guide](#).
- See the [Spartan-3 Data Sheets](#).

## CAPTURE\_SPARTAN3

Primitive: Spartan-3 Register State Capture for Bitstream Readback

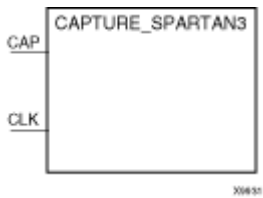

### Introduction

This element provides user control and synchronization over when and how the capture register (flip-flop and latch) information task is requested. The readback function is provided through dedicated configuration port instructions. However, without this element, the readback data is synchronized to the configuration clock. Only register (flip-flop and latch) states can be captured. Although LUT RAM, SRL, and block RAM states are readback, they cannot be captured.

An asserted high CAP signal indicates that the registers in the device are to be captured at the next Low-to-High clock transition. By default, data is captured after every trigger when transition on CLK while CAP is asserted. To limit the readback operation to a single data capture, add the ONESHOT=TRUE attribute to this element.

### Port Descriptions

Name	Direction	Width	Function
CAP	Input	1-bit	Readback capture trigger
CLK	Input	1-bit	Readback capture clock

### Design Entry Method

This design element can be used in schematics.

Connect all inputs and outputs to the design in order to ensure proper operation.

### Available Attributes

Attribute	Type	Allowed Values	Default	Description
ONESHOT	Boolean	TRUE, FALSE	TRUE	Specifies the procedure for performing single readback per CAP trigger.

### For More Information

- See the [Spartan-3 User Guide](#).
- See the [Spartan-3 Data Sheets](#).

## CB16CE

Macro: 16-Bit Cascadable Binary Counter with Clock Enable and Asynchronous Clear

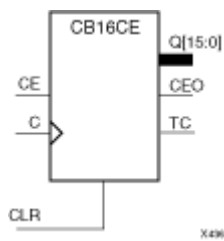

### Introduction

This design element is an asynchronously clearable, cascadable binary counter. The asynchronous clear (CLR) input, when High, overrides all other inputs and forces the Q outputs, terminal count (TC), and clock enable out (CEO) to logic level zero, independent of clock transitions. The Q outputs increment when the clock enable input (CE) is High during the Low-to-High clock (C) transition. The counter ignores clock transitions when CE is Low. The TC output is High when all Q outputs are High.

Create larger counters by connecting the CEO output of each stage to the CE input of the next stage and connecting the C and CLR inputs in parallel. CEO is active (High) when TC and CE are High. The maximum length of the counter is determined by the accumulated CE-to-TC propagation delays versus the clock period. The clock period must be greater than  $n(t_{CE-TC})$ , where  $n$  is the number of stages and the time  $t_{CE-TC}$  is the CE-to-TC propagation delay of each stage. When cascading counters, use the CEO output if the counter uses the CE input or use the TC output if it does not.

This counter is asynchronously cleared, outputs Low, when power is applied. For FPGA devices, power-on conditions are simulated when global set/reset (GSR) is active. GSR defaults to active-High but can be inverted by adding an inverter in front of the GSR input of the appropriate `STARTUP_architecture` symbol.

### Logic Table

Inputs			Outputs		
CLR	CE	C	Qz-Q0	TC	CEO
1	X	X	0	0	0
0	0	X	No change	No change	0
0	1	↑	Inc	TC	CEO

z = bit width - 1  
 $TC = Qz \cdot Q(z-1) \cdot Q(z-2) \cdot \dots \cdot Q0$   
 $CEO = TC \cdot CE$

### Design Entry Method

This design element is only for use in schematics.

### For More Information

- See the [Spartan-3 User Guide](#).
- See the [Spartan-3 Data Sheets](#).

## CB16CLE

Macro: 16-Bit Loadable Cascadable Binary Counters with Clock Enable and Asynchronous Clear

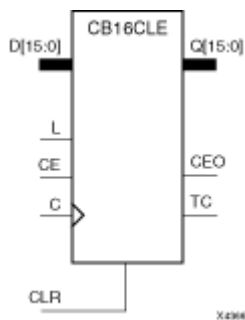

### Introduction

This element is a synchronously loadable, asynchronously clearable, cascadable binary counter. The asynchronous clear (CLR) input, when High, overrides all other inputs and forces the Q outputs, terminal count (TC), and clock enable out (CEO) to logic level zero, independent of clock transitions. The data on the D inputs is loaded into the counter when the load enable input (L) is High during the Low-to-High clock transition, independent of the state of clock enable (CE). The Q outputs increment when CE is High during the Low-to-High clock transition. The counter ignores clock transitions when CE is Low. The TC output is High when all Q outputs are High.

Create larger counters by connecting the CEO output of each stage to the CE input of the next stage and connecting the C, L, and CLR inputs in parallel. CEO is active (High) when TC and CE are High. The maximum length of the counter is determined by the accumulated CE-to-TC propagation delays versus the clock period. The clock period must be greater than  $n(t_{CE-TC})$ , where  $n$  is the number of stages and the time  $t_{CE-TC}$  is the CE-to-TC propagation delay of each stage. When cascading counters, use the CEO output if the counter uses the CE input or use the TC output if it does not.

This counter is asynchronously cleared, outputs Low, when power is applied. For FPGA devices, power-on conditions are simulated when global set/reset (GSR) is active. GSR defaults to active-High but can be inverted by adding an inverter in front of the GSR input of the appropriate `STARTUP_architecture` symbol.

### Logic Table

Inputs					Outputs		
CLR	L	CE	C	D <sub>z</sub> - D <sub>0</sub>	Q <sub>z</sub> - Q <sub>0</sub>	TC	CEO
1	X	X	X	X	0	0	0
0	1	X	↑	D <sub>n</sub>	D <sub>n</sub>	TC	CEO
0	0	0	X	X	No change	No change	0
0	0	1	↑	X	Inc	TC	CEO

z = bit width - 1  
 $TC = Q_z \cdot Q_{(z-1)} \cdot Q_{(z-2)} \cdot \dots \cdot Q_0$   
 $CEO = TC \cdot CE$

### Design Entry Method

This design element is only for use in schematics.



---

## For More Information

- See the [Spartan-3 User Guide](#).
- See the [Spartan-3 Data Sheets](#).

## CB16CLED

Macro: 16-Bit Loadable Cascadable Bidirectional Binary Counters with Clock Enable and Asynchronous Clear

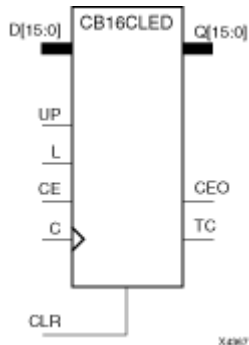

### Introduction

This design element is a synchronously loadable, asynchronously clearable, cascadable, bidirectional binary counter. The asynchronous clear (CLR) input, when High, overrides all other inputs and forces the Q outputs, terminal count (TC), and clock enable out (CEO) to logic level zero, independent of clock transitions. The data on the D inputs is loaded into the counter when the load enable input (L) is High during the Low-to-High clock (C) transition, independent of the state of clock enable (CE). The Q outputs decrement when CE is High and UP is Low during the Low-to-High clock transition. The Q outputs increment when CE and UP are High. The counter ignores clock transitions when CE is Low.

For counting up, the TC output is High when all Q outputs and UP are High. For counting down, the TC output is High when all Q outputs and UP are Low.

Create larger counters by connecting the CEO output of each stage to the CE input of the next stage and connecting the C, UP, L, and CLR inputs in parallel. CEO is active (High) when TC and CE are High. The maximum length of the counter is determined by the accumulated CE-to-TC propagation delays versus the clock period. The clock period must be greater than  $n(t_{CE-TC})$ , where  $n$  is the number of stages and the time  $t_{CE-TC}$  is the CE-to-TC propagation delay of each stage. When cascading counters, use the CEO output if the counter uses the CE input or use the TC output if it does not.

For CPLD parts, see "CB2X1", "CB4X1", "CB8X1", "CB16X1" for high-performance cascadable, bidirectional counters.

This counter is asynchronously cleared, outputs Low, when power is applied. For FPGA devices, power-on conditions are simulated when global set/reset (GSR) is active. GSR defaults to active-High but can be inverted by adding an inverter in front of the GSR input of the appropriate `STARTUP_architecture` symbol.

### Logic Table

Inputs						Outputs		
CLR	L	CE	C	UP	Dz – D0	Qz – Q0	TC	CEO
1	X	X	X	X	X	0	0	0
0	1	X	↑	X	Dn	Dn	TC	CEO
0	0	0	X	X	X	No change	No change	0
0	0	1	↑	1	X	Inc	TC	CEO

Inputs						Outputs		
CLR	L	CE	C	UP	D <sub>z</sub> - D <sub>0</sub>	Q <sub>z</sub> - Q <sub>0</sub>	TC	CEO
0	0	1	↑	0	X	Dec	TC	CEO
z = bit width - 1 $TC = (Q_z \cdot Q_{(z-1)} \cdot Q_{(z-2)} \cdot \dots \cdot Q_0 \cdot UP) + (Q_z \cdot Q_{(z-1)} \cdot Q_{(z-2)} \cdot \dots \cdot Q_0 \cdot UP)$ $CEO = TC \cdot CE$								

## Design Entry Method

This design element is only for use in schematics.

## For More Information

- See the [Spartan-3 User Guide](#).
- See the [Spartan-3 Data Sheets](#).

## CB16RE

Macro: 16-Bit Cascadable Binary Counter with Clock Enable and Synchronous Reset

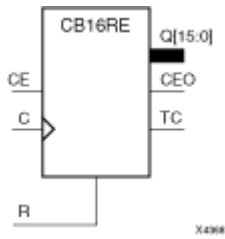

### Introduction

This design element is a synchronous, resettable, cascadable binary counter. The synchronous reset (R), when High, overrides all other inputs and forces the Q outputs, terminal count (TC), and clock enable out (CEO) to zero on the Low-to-High clock transition. The Q outputs increment when the clock enable input (CE) is High during the Low-to-High clock (C) transition. The counter ignores clock transitions when CE is Low. The TC output is High when both Q outputs are High.

Create larger counters by connecting the CEO output of each stage to the CE input of the next stage and connecting the C and R inputs in parallel. CEO is active (High) when TC and CE are High. The maximum length of the counter is determined by the accumulated CE-to-TC propagation delays versus the clock period. The clock period must be greater than  $n(t_{CE-TC})$ , where  $n$  is the number of stages and the time  $t_{CE-TC}$  is the CE-to-TC propagation delay of each stage. When cascading counters, use the CEO output if the counter uses the CE input or use the TC output if it does not.

This counter is asynchronously cleared, outputs Low, when power is applied. For FPGA devices, power-on conditions are simulated when global set/reset (GSR) is active. GSR defaults to active-High but can be inverted by adding an inverter in front of the GSR input of the appropriate `STARTUP_architecture` symbol.

### Logic Table

Inputs			Outputs		
R	CE	C	Qz-Q0	TC	CEO
1	X	↑	0	0	0
0	0	X	No change	No change	0
0	1	↑	Inc	TC	CEO

$z = \text{bit width} - 1$   
 $TC = Qz \cdot Q(z-1) \cdot Q(z-2) \cdot \dots \cdot Q0$   
 $CEO = TC \cdot CE$

### Design Entry Method

This design element is only for use in schematics.

### For More Information

- See the [Spartan-3 User Guide](#).
- See the [Spartan-3 Data Sheets](#).

# CB2CE

Macro: 2-Bit Cascadable Binary Counter with Clock Enable and Asynchronous Clear

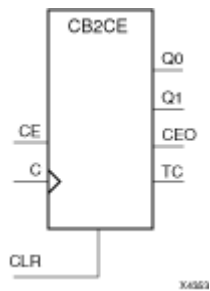

## Introduction

This design element is an asynchronously clearable, cascadable binary counter. The asynchronous clear (CLR) input, when High, overrides all other inputs and forces the Q outputs, terminal count (TC), and clock enable out (CEO) to logic level zero, independent of clock transitions. The Q outputs increment when the clock enable input (CE) is High during the Low-to-High clock (C) transition. The counter ignores clock transitions when CE is Low. The TC output is High when all Q outputs are High.

Create larger counters by connecting the CEO output of each stage to the CE input of the next stage and connecting the C and CLR inputs in parallel. CEO is active (High) when TC and CE are High. The maximum length of the counter is determined by the accumulated CE-to-TC propagation delays versus the clock period. The clock period must be greater than  $n(t_{CE-TC})$ , where  $n$  is the number of stages and the time  $t_{CE-TC}$  is the CE-to-TC propagation delay of each stage. When cascading counters, use the CEO output if the counter uses the CE input or use the TC output if it does not.

This counter is asynchronously cleared, outputs Low, when power is applied. For FPGA devices, power-on conditions are simulated when global set/reset (GSR) is active. GSR defaults to active-High but can be inverted by adding an inverter in front of the GSR input of the appropriate `STARTUP_architecture` symbol.

## Logic Table

Inputs			Outputs		
CLR	CE	C	Qz-Q0	TC	CEO
1	X	X	0	0	0
0	0	X	No change	No change	0
0	1	↑	Inc	TC	CEO

z = bit width - 1  
 $TC = Qz \cdot Q(z-1) \cdot Q(z-2) \cdot \dots \cdot Q0$   
 $CEO = TC \cdot CE$

## Design Entry Method

This design element is only for use in schematics.

## For More Information

- See the [Spartan-3 User Guide](#).
- See the [Spartan-3 Data Sheets](#).

## CB2CLE

Macro: 2-Bit Loadable Cascadable Binary Counters with Clock Enable and Asynchronous Clear

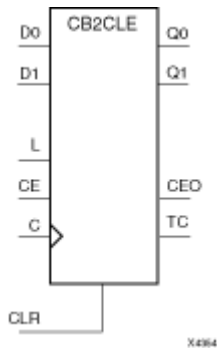

### Introduction

This element is a synchronously loadable, asynchronously clearable, cascadable binary counter. The asynchronous clear (CLR) input, when High, overrides all other inputs and forces the Q outputs, terminal count (TC), and clock enable out (CEO) to logic level zero, independent of clock transitions. The data on the D inputs is loaded into the counter when the load enable input (L) is High during the Low-to-High clock transition, independent of the state of clock enable (CE). The Q outputs increment when CE is High during the Low-to-High clock transition. The counter ignores clock transitions when CE is Low. The TC output is High when all Q outputs are High.

Create larger counters by connecting the CEO output of each stage to the CE input of the next stage and connecting the C, L, and CLR inputs in parallel. CEO is active (High) when TC and CE are High. The maximum length of the counter is determined by the accumulated CE-to-TC propagation delays versus the clock period. The clock period must be greater than  $n(t_{CE-TC})$ , where  $n$  is the number of stages and the time  $t_{CE-TC}$  is the CE-to-TC propagation delay of each stage. When cascading counters, use the CEO output if the counter uses the CE input or use the TC output if it does not.

This counter is asynchronously cleared, outputs Low, when power is applied. For FPGA devices, power-on conditions are simulated when global set/reset (GSR) is active. GSR defaults to active-High but can be inverted by adding an inverter in front of the GSR input of the appropriate `STARTUP_architecture` symbol.

### Logic Table

Inputs				Outputs			
CLR	L	CE	C	D <sub>z</sub> - D <sub>0</sub>	Q <sub>z</sub> - Q <sub>0</sub>	TC	CEO
1	X	X	X	X	0	0	0
0	1	X	↑	D <sub>n</sub>	D <sub>n</sub>	TC	CEO
0	0	0	X	X	No change	No change	0
0	0	1	↑	X	Inc	TC	CEO

z = bit width - 1  
 $TC = Q_z \cdot Q_{(z-1)} \cdot Q_{(z-2)} \cdot \dots \cdot Q_0$   
 $CEO = TC \cdot CE$

### Design Entry Method

This design element is only for use in schematics.

---

## For More Information

- See the [Spartan-3 User Guide](#).
- See the [Spartan-3 Data Sheets](#).

## CB2CLED

Macro: 2-Bit Loadable Cascadable Bidirectional Binary Counters with Clock Enable and Asynchronous Clear

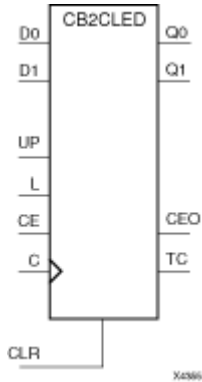

### Introduction

This design element is a synchronously loadable, asynchronously clearable, cascadable, bidirectional binary counter. The asynchronous clear (CLR) input, when High, overrides all other inputs and forces the Q outputs, terminal count (TC), and clock enable out (CEO) to logic level zero, independent of clock transitions. The data on the D inputs is loaded into the counter when the load enable input (L) is High during the Low-to-High clock (C) transition, independent of the state of clock enable (CE). The Q outputs decrement when CE is High and UP is Low during the Low-to-High clock transition. The Q outputs increment when CE and UP are High. The counter ignores clock transitions when CE is Low.

For counting up, the TC output is High when all Q outputs and UP are High. For counting down, the TC output is High when all Q outputs and UP are Low.

Create larger counters by connecting the CEO output of each stage to the CE input of the next stage and connecting the C, UP, L, and CLR inputs in parallel. CEO is active (High) when TC and CE are High. The maximum length of the counter is determined by the accumulated CE-to-TC propagation delays versus the clock period. The clock period must be greater than  $n(t_{CE-TC})$ , where  $n$  is the number of stages and the time  $t_{CE-TC}$  is the CE-to-TC propagation delay of each stage. When cascading counters, use the CEO output if the counter uses the CE input or use the TC output if it does not.

For CPLD parts, see "CB2X1", "CB4X1", "CB8X1", "CB16X1" for high-performance cascadable, bidirectional counters.

This counter is asynchronously cleared, outputs Low, when power is applied. For FPGA devices, power-on conditions are simulated when global set/reset (GSR) is active. GSR defaults to active-High but can be inverted by adding an inverter in front of the GSR input of the appropriate STARTUP\_architecture symbol.

### Logic Table

Inputs						Outputs		
CLR	L	CE	C	UP	Dz - D0	Qz - Q0	TC	CEO
1	X	X	X	X	X	0	0	0
0	1	X	↑	X	Dn	Dn	TC	CEO
0	0	0	X	X	X	No change	No change	0
0	0	1	↑	1	X	Inc	TC	CEO



Inputs						Outputs		
CLR	L	CE	C	UP	Dz - D0	Qz - Q0	TC	CEO
0	0	1	↑	0	X	Dec	TC	CEO
z = bit width - 1 $TC = (Qz \cdot Q(z-1) \cdot Q(z-2) \cdot \dots \cdot Q0 \cdot UP) + (Qz \cdot Q(z-1) \cdot Q(z-2) \cdot \dots \cdot Q0 \cdot UP)$ $CEO = TC \cdot CE$								

## Design Entry Method

This design element is only for use in schematics.

## For More Information

- See the [Spartan-3 User Guide](#).
- See the [Spartan-3 Data Sheets](#).

## CB2RE

Macro: 2-Bit Cascadable Binary Counter with Clock Enable and Synchronous Reset

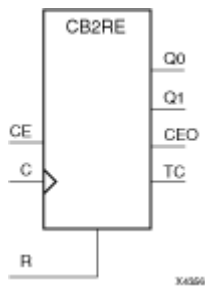

### Introduction

This design element is a synchronous, resettable, cascadable binary counter. The synchronous reset (R), when High, overrides all other inputs and forces the Q outputs, terminal count (TC), and clock enable out (CEO) to zero on the Low-to-High clock transition. The Q outputs increment when the clock enable input (CE) is High during the Low-to-High clock (C) transition. The counter ignores clock transitions when CE is Low. The TC output is High when both Q outputs are High.

Create larger counters by connecting the CEO output of each stage to the CE input of the next stage and connecting the C and R inputs in parallel. CEO is active (High) when TC and CE are High. The maximum length of the counter is determined by the accumulated CE-to-TC propagation delays versus the clock period. The clock period must be greater than  $n(t_{CE-TC})$ , where  $n$  is the number of stages and the time  $t_{CE-TC}$  is the CE-to-TC propagation delay of each stage. When cascading counters, use the CEO output if the counter uses the CE input or use the TC output if it does not.

This counter is asynchronously cleared, outputs Low, when power is applied. For FPGA devices, power-on conditions are simulated when global set/reset (GSR) is active. GSR defaults to active-High but can be inverted by adding an inverter in front of the GSR input of the appropriate `STARTUP_architecture` symbol.

### Logic Table

Inputs			Outputs		
R	CE	C	Qz-Q0	TC	CEO
1	X	↑	0	0	0
0	0	X	No change	No change	0
0	1	↑	Inc	TC	CEO

z = bit width - 1  
 $TC = Qz \cdot Q(z-1) \cdot Q(z-2) \cdot \dots \cdot Q0$   
 $CEO = TC \cdot CE$

### Design Entry Method

This design element is only for use in schematics.

### For More Information

- See the [Spartan-3 User Guide](#).
- See the [Spartan-3 Data Sheets](#).

## CB4CE

Macro: 4-Bit Cascadable Binary Counter with Clock Enable and Asynchronous Clear

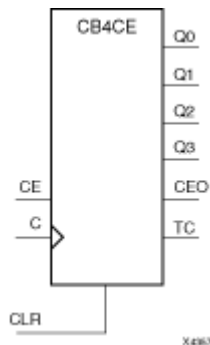

### Introduction

This design element is an asynchronously clearable, cascadable binary counter. The asynchronous clear (CLR) input, when High, overrides all other inputs and forces the Q outputs, terminal count (TC), and clock enable out (CEO) to logic level zero, independent of clock transitions. The Q outputs increment when the clock enable input (CE) is High during the Low-to-High clock (C) transition. The counter ignores clock transitions when CE is Low. The TC output is High when all Q outputs are High.

Create larger counters by connecting the CEO output of each stage to the CE input of the next stage and connecting the C and CLR inputs in parallel. CEO is active (High) when TC and CE are High. The maximum length of the counter is determined by the accumulated CE-to-TC propagation delays versus the clock period. The clock period must be greater than  $n(t_{CE-TC})$ , where  $n$  is the number of stages and the time  $t_{CE-TC}$  is the CE-to-TC propagation delay of each stage. When cascading counters, use the CEO output if the counter uses the CE input or use the TC output if it does not.

This counter is asynchronously cleared, outputs Low, when power is applied. For FPGA devices, power-on conditions are simulated when global set/reset (GSR) is active. GSR defaults to active-High but can be inverted by adding an inverter in front of the GSR input of the appropriate `STARTUP_architecture` symbol.

### Logic Table

Inputs			Outputs		
CLR	CE	C	Qz-Q0	TC	CEO
1	X	X	0	0	0
0	0	X	No change	No change	0
0	1	↑	Inc	TC	CEO

z = bit width - 1  
 $TC = Q_z \cdot Q_{(z-1)} \cdot Q_{(z-2)} \cdot \dots \cdot Q_0$   
 $CEO = TC \cdot CE$

### Design Entry Method

This design element is only for use in schematics.

### For More Information

- See the [Spartan-3 User Guide](#).
- See the [Spartan-3 Data Sheets](#).

## CB4CLE

Macro: 4-Bit Loadable Cascadable Binary Counters with Clock Enable and Asynchronous Clear

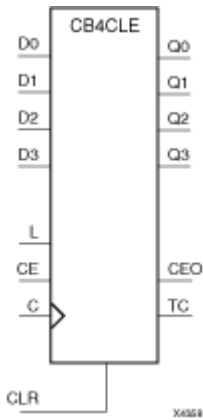

### Introduction

This element is a synchronously loadable, asynchronously clearable, cascadable binary counter. The asynchronous clear (CLR) input, when High, overrides all other inputs and forces the Q outputs, terminal count (TC), and clock enable out (CEO) to logic level zero, independent of clock transitions. The data on the D inputs is loaded into the counter when the load enable input (L) is High during the Low-to-High clock transition, independent of the state of clock enable (CE). The Q outputs increment when CE is High during the Low-to-High clock transition. The counter ignores clock transitions when CE is Low. The TC output is High when all Q outputs are High.

Create larger counters by connecting the CEO output of each stage to the CE input of the next stage and connecting the C, L, and CLR inputs in parallel. CEO is active (High) when TC and CE are High. The maximum length of the counter is determined by the accumulated CE-to-TC propagation delays versus the clock period. The clock period must be greater than  $n(t_{CE-TC})$ , where  $n$  is the number of stages and the time  $t_{CE-TC}$  is the CE-to-TC propagation delay of each stage. When cascading counters, use the CEO output if the counter uses the CE input or use the TC output if it does not.

This counter is asynchronously cleared, outputs Low, when power is applied. For FPGA devices, power-on conditions are simulated when global set/reset (GSR) is active. GSR defaults to active-High but can be inverted by adding an inverter in front of the GSR input of the appropriate `STARTUP_architecture` symbol.

### Logic Table

Inputs					Outputs		
CLR	L	CE	C	D <sub>z</sub> - D <sub>0</sub>	Q <sub>z</sub> - Q <sub>0</sub>	TC	CEO
1	X	X	X	X	0	0	0
0	1	X	↑	D <sub>n</sub>	D <sub>n</sub>	TC	CEO
0	0	0	X	X	No change	No change	0
0	0	1	↑	X	Inc	TC	CEO

z = bit width - 1  
 $TC = Q_z \cdot Q_{(z-1)} \cdot Q_{(z-2)} \cdot \dots \cdot Q_0$   
 $CEO = TC \cdot CE$

---

## Design Entry Method

This design element is only for use in schematics.

## For More Information

- See the [Spartan-3 User Guide](#).
- See the [Spartan-3 Data Sheets](#).

## CB4CLED

Macro: 4-Bit Loadable Cascadable Bidirectional Binary Counters with Clock Enable and Asynchronous Clear

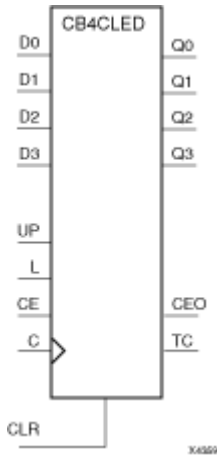

### Introduction

This design element is a synchronously loadable, asynchronously clearable, cascadable, bidirectional binary counter. The asynchronous clear (CLR) input, when High, overrides all other inputs and forces the Q outputs, terminal count (TC), and clock enable out (CEO) to logic level zero, independent of clock transitions. The data on the D inputs is loaded into the counter when the load enable input (L) is High during the Low-to-High clock (C) transition, independent of the state of clock enable (CE). The Q outputs decrement when CE is High and UP is Low during the Low-to-High clock transition. The Q outputs increment when CE and UP are High. The counter ignores clock transitions when CE is Low.

For counting up, the TC output is High when all Q outputs and UP are High. For counting down, the TC output is High when all Q outputs and UP are Low.

Create larger counters by connecting the CEO output of each stage to the CE input of the next stage and connecting the C, UP, L, and CLR inputs in parallel. CEO is active (High) when TC and CE are High. The maximum length of the counter is determined by the accumulated CE-to-TC propagation delays versus the clock period. The clock period must be greater than  $n(t_{CE-TC})$ , where  $n$  is the number of stages and the time  $t_{CE-TC}$  is the CE-to-TC propagation delay of each stage. When cascading counters, use the CEO output if the counter uses the CE input or use the TC output if it does not.

For CPLD parts, see “CB2X1”, “CB4X1”, “CB8X1”, “CB16X1” for high-performance cascadable, bidirectional counters.

This counter is asynchronously cleared, outputs Low, when power is applied. For FPGA devices, power-on conditions are simulated when global set/reset (GSR) is active. GSR defaults to active-High but can be inverted by adding an inverter in front of the GSR input of the appropriate STARTUP\_architecture symbol.

### Logic Table

Inputs						Outputs		
CLR	L	CE	C	UP	Dz – D0	Qz – Q0	TC	CEO
1	X	X	X	X	X	0	0	0
0	1	X	↑	X	Dn	Dn	TC	CEO
0	0	0	X	X	X	No change	No change	0
0	0	1	↑	1	X	Inc	TC	CEO

Inputs						Outputs		
CLR	L	CE	C	UP	D <sub>z</sub> - D <sub>0</sub>	Q <sub>z</sub> - Q <sub>0</sub>	TC	CEO
0	0	1	↑	0	X	Dec	TC	CEO
$z = \text{bit width} - 1$ $TC = (Q_z \cdot Q_{(z-1)} \cdot Q_{(z-2)} \cdot \dots \cdot Q_0 \cdot UP) + (Q_z \cdot Q_{(z-1)} \cdot Q_{(z-2)} \cdot \dots \cdot Q_0 \cdot UP)$ $CEO = TC \cdot CE$								

## Design Entry Method

This design element is only for use in schematics.

## For More Information

- See the [Spartan-3 User Guide](#).
- See the [Spartan-3 Data Sheets](#).

## CB4RE

Macro: 4-Bit Cascadable Binary Counter with Clock Enable and Synchronous Reset

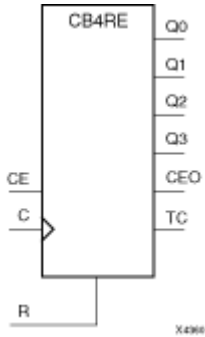

### Introduction

This design element is a synchronous, resettable, cascadable binary counter. The synchronous reset (R), when High, overrides all other inputs and forces the Q outputs, terminal count (TC), and clock enable out (CEO) to zero on the Low-to-High clock transition. The Q outputs increment when the clock enable input (CE) is High during the Low-to-High clock (C) transition. The counter ignores clock transitions when CE is Low. The TC output is High when both Q outputs are High.

Create larger counters by connecting the CEO output of each stage to the CE input of the next stage and connecting the C and R inputs in parallel. CEO is active (High) when TC and CE are High. The maximum length of the counter is determined by the accumulated CE-to-TC propagation delays versus the clock period. The clock period must be greater than  $n(t_{CE-TC})$ , where  $n$  is the number of stages and the time  $t_{CE-TC}$  is the CE-to-TC propagation delay of each stage. When cascading counters, use the CEO output if the counter uses the CE input or use the TC output if it does not.

This counter is asynchronously cleared, outputs Low, when power is applied. For FPGA devices, power-on conditions are simulated when global set/reset (GSR) is active. GSR defaults to active-High but can be inverted by adding an inverter in front of the GSR input of the appropriate `STARTUP_architecture` symbol.

### Logic Table

Inputs			Outputs		
R	CE	C	Qz-Q0	TC	CEO
1	X	↑	0	0	0
0	0	X	No change	No change	0
0	1	↑	Inc	TC	CEO

$z = \text{bit width} - 1$   
 $TC = Q_z \cdot Q_{(z-1)} \cdot Q_{(z-2)} \cdot \dots \cdot Q_0$   
 $CEO = TC \cdot CE$

### Design Entry Method

This design element is only for use in schematics.

### For More Information

- See the [Spartan-3 User Guide](#).
- See the [Spartan-3 Data Sheets](#).



## CB8CE

Macro: 8-Bit Cascadable Binary Counter with Clock Enable and Asynchronous Clear

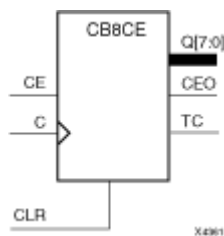

### Introduction

This design element is an asynchronously clearable, cascadable binary counter. The asynchronous clear (CLR) input, when High, overrides all other inputs and forces the Q outputs, terminal count (TC), and clock enable out (CEO) to logic level zero, independent of clock transitions. The Q outputs increment when the clock enable input (CE) is High during the Low-to-High clock (C) transition. The counter ignores clock transitions when CE is Low. The TC output is High when all Q outputs are High.

Create larger counters by connecting the CEO output of each stage to the CE input of the next stage and connecting the C and CLR inputs in parallel. CEO is active (High) when TC and CE are High. The maximum length of the counter is determined by the accumulated CE-to-TC propagation delays versus the clock period. The clock period must be greater than  $n(t_{CE-TC})$ , where  $n$  is the number of stages and the time  $t_{CE-TC}$  is the CE-to-TC propagation delay of each stage. When cascading counters, use the CEO output if the counter uses the CE input or use the TC output if it does not.

This counter is asynchronously cleared, outputs Low, when power is applied. For FPGA devices, power-on conditions are simulated when global set/reset (GSR) is active. GSR defaults to active-High but can be inverted by adding an inverter in front of the GSR input of the appropriate `STARTUP_architecture` symbol.

### Logic Table

Inputs			Outputs		
CLR	CE	C	Q <sub>z</sub> -Q <sub>0</sub>	TC	CEO
1	X	X	0	0	0
0	0	X	No change	No change	0
0	1	↑	Inc	TC	CEO

z = bit width - 1  
 $TC = Q_z \cdot Q_{(z-1)} \cdot Q_{(z-2)} \cdot \dots \cdot Q_0$   
 $CEO = TC \cdot CE$

### Design Entry Method

This design element is only for use in schematics.

### For More Information

- See the [Spartan-3 User Guide](#).
- See the [Spartan-3 Data Sheets](#).

## CB8CLE

Macro: 8-Bit Loadable Cascadable Binary Counters with Clock Enable and Asynchronous Clear

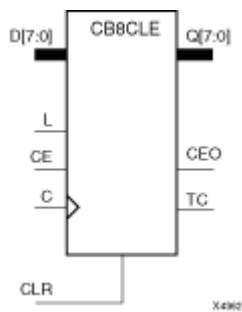

### Introduction

This element is a synchronously loadable, asynchronously clearable, cascadable binary counter. The asynchronous clear (CLR) input, when High, overrides all other inputs and forces the Q outputs, terminal count (TC), and clock enable out (CEO) to logic level zero, independent of clock transitions. The data on the D inputs is loaded into the counter when the load enable input (L) is High during the Low-to-High clock transition, independent of the state of clock enable (CE). The Q outputs increment when CE is High during the Low-to-High clock transition. The counter ignores clock transitions when CE is Low. The TC output is High when all Q outputs are High.

Create larger counters by connecting the CEO output of each stage to the CE input of the next stage and connecting the C, L, and CLR inputs in parallel. CEO is active (High) when TC and CE are High. The maximum length of the counter is determined by the accumulated CE-to-TC propagation delays versus the clock period. The clock period must be greater than  $n(t_{CE-TC})$ , where  $n$  is the number of stages and the time  $t_{CE-TC}$  is the CE-to-TC propagation delay of each stage. When cascading counters, use the CEO output if the counter uses the CE input or use the TC output if it does not.

This counter is asynchronously cleared, outputs Low, when power is applied. For FPGA devices, power-on conditions are simulated when global set/reset (GSR) is active. GSR defaults to active-High but can be inverted by adding an inverter in front of the GSR input of the appropriate `STARTUP_architecture` symbol.

### Logic Table

Inputs					Outputs		
CLR	L	CE	C	D <sub>z</sub> - D <sub>0</sub>	Q <sub>z</sub> - Q <sub>0</sub>	TC	CEO
1	X	X	X	X	0	0	0
0	1	X	↑	D <sub>n</sub>	D <sub>n</sub>	TC	CEO
0	0	0	X	X	No change	No change	0
0	0	1	↑	X	Inc	TC	CEO

$z = \text{bit width} - 1$   
 $TC = Q_z \cdot Q_{(z-1)} \cdot Q_{(z-2)} \cdot \dots \cdot Q_0$   
 $CEO = TC \cdot CE$

### Design Entry Method

This design element is only for use in schematics.

---

## For More Information

- See the [Spartan-3 User Guide](#).
- See the [Spartan-3 Data Sheets](#).

## CB8CLED

Macro: 8-Bit Loadable Cascadable Bidirectional Binary Counters with Clock Enable and Asynchronous Clear

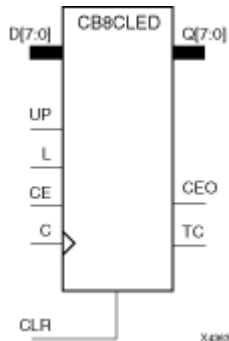

### Introduction

This design element is a synchronously loadable, asynchronously clearable, cascadable, bidirectional binary counter. The asynchronous clear (CLR) input, when High, overrides all other inputs and forces the Q outputs, terminal count (TC), and clock enable out (CEO) to logic level zero, independent of clock transitions. The data on the D inputs is loaded into the counter when the load enable input (L) is High during the Low-to-High clock (C) transition, independent of the state of clock enable (CE). The Q outputs decrement when CE is High and UP is Low during the Low-to-High clock transition. The Q outputs increment when CE and UP are High. The counter ignores clock transitions when CE is Low.

For counting up, the TC output is High when all Q outputs and UP are High. For counting down, the TC output is High when all Q outputs and UP are Low.

Create larger counters by connecting the CEO output of each stage to the CE input of the next stage and connecting the C, UP, L, and CLR inputs in parallel. CEO is active (High) when TC and CE are High. The maximum length of the counter is determined by the accumulated CE-to-TC propagation delays versus the clock period. The clock period must be greater than  $n(t_{CE-TC})$ , where  $n$  is the number of stages and the time  $t_{CE-TC}$  is the CE-to-TC propagation delay of each stage. When cascading counters, use the CEO output if the counter uses the CE input or use the TC output if it does not.

For CPLD parts, see “CB2X1”, “CB4X1”, “CB8X1”, “CB16X1” for high-performance cascadable, bidirectional counters.

This counter is asynchronously cleared, outputs Low, when power is applied. For FPGA devices, power-on conditions are simulated when global set/reset (GSR) is active. GSR defaults to active-High but can be inverted by adding an inverter in front of the GSR input of the appropriate STARTUP\_architecture symbol.

### Logic Table

Inputs						Outputs		
CLR	L	CE	C	UP	Dz - D0	Qz - Q0	TC	CEO
1	X	X	X	X	X	0	0	0
0	1	X	↑	X	Dn	Dn	TC	CEO
0	0	0	X	X	X	No change	No change	0
0	0	1	↑	1	X	Inc	TC	CEO

Inputs						Outputs		
CLR	L	CE	C	UP	D <sub>z</sub> - D <sub>0</sub>	Q <sub>z</sub> - Q <sub>0</sub>	TC	CEO
0	0	1	↑	0	X	Dec	TC	CEO
z = bit width - 1 $TC = (Q_z \cdot Q_{(z-1)} \cdot Q_{(z-2)} \cdot \dots \cdot Q_0 \cdot UP) + (Q_z \cdot Q_{(z-1)} \cdot Q_{(z-2)} \cdot \dots \cdot Q_0 \cdot UP)$ $CEO = TC \cdot CE$								

## Design Entry Method

This design element is only for use in schematics.

## For More Information

- See the [Spartan-3 User Guide](#).
- See the [Spartan-3 Data Sheets](#).

## CB8RE

Macro: 8-Bit Cascadable Binary Counter with Clock Enable and Synchronous Reset

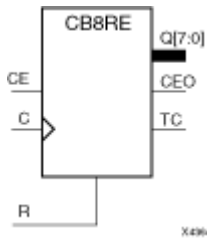

### Introduction

This design element is a synchronous, resettable, cascadable binary counter. The synchronous reset (R), when High, overrides all other inputs and forces the Q outputs, terminal count (TC), and clock enable out (CEO) to zero on the Low-to-High clock transition. The Q outputs increment when the clock enable input (CE) is High during the Low-to-High clock (C) transition. The counter ignores clock transitions when CE is Low. The TC output is High when both Q outputs are High.

Create larger counters by connecting the CEO output of each stage to the CE input of the next stage and connecting the C and R inputs in parallel. CEO is active (High) when TC and CE are High. The maximum length of the counter is determined by the accumulated CE-to-TC propagation delays versus the clock period. The clock period must be greater than  $n(t_{CE-TC})$ , where  $n$  is the number of stages and the time  $t_{CE-TC}$  is the CE-to-TC propagation delay of each stage. When cascading counters, use the CEO output if the counter uses the CE input or use the TC output if it does not.

This counter is asynchronously cleared, outputs Low, when power is applied. For FPGA devices, power-on conditions are simulated when global set/reset (GSR) is active. GSR defaults to active-High but can be inverted by adding an inverter in front of the GSR input of the appropriate `STARTUP_architecture` symbol.

### Logic Table

Inputs			Outputs		
R	CE	C	Q <sub>z</sub> -Q <sub>0</sub>	TC	CEO
1	X	↑	0	0	0
0	0	X	No change	No change	0
0	1	↑	Inc	TC	CEO
z = bit width - 1 $TC = Q_z \cdot Q_{(z-1)} \cdot Q_{(z-2)} \cdot \dots \cdot Q_0$ $CEO = TC \cdot CE$					

### Design Entry Method

This design element is only for use in schematics.

### For More Information

- See the [Spartan-3 User Guide](#).
- See the [Spartan-3 Data Sheets](#).

## CC16CE

Macro: 16-Bit Cascadable Binary Counter with Clock Enable and Asynchronous Clear

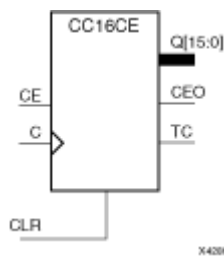

### Introduction

This design element is an asynchronously clearable, cascadable binary counter. It is implemented using carry logic with relative location constraints to ensure efficient logic placement. The asynchronous clear (CLR) is the highest priority input. When CLR is High, all other inputs are ignored; the Q outputs, terminal count (TC), and clock enable out (CEO) go to logic level zero, independent of clock transitions. The Q outputs increment when the clock enable input (CE) is High during the Low-to-High clock (C) transition. The counter ignores clock transitions when CE is Low. The TC output is High when all Q outputs are High.

Create larger counters by connecting the CEO output of each stage to the CE input of the next stage and connecting the C and CLR inputs in parallel. CEO is active (High) when TC and CE are High. The maximum length of the counter is determined by the accumulated CE-to-TC propagation delays versus the clock period. The clock period must be greater than  $n(t_{CE-TC})$ , where  $n$  is the number of stages and the time  $t_{CE-TC}$  is the CE-to-TC propagation delay of each stage. When cascading counters, use the CEO output if the counter uses the CE input or use the TC output if it does not.

This counter is asynchronously cleared, outputs Low, when power is applied. For FPGA devices, power-on conditions are simulated when global set/reset (GSR) is active. GSR defaults to active-High but can be inverted by adding an inverter in front of the GSR input of the appropriate `STARTUP_architecture` symbol.

### Logic Table

Inputs			Outputs		
CLR	CE	C	Q <sub>z</sub> -Q <sub>0</sub>	TC	CEO
1	X	X	0	0	0
0	0	X	No change	No change	0
0	1	↑	Inc	TC	CEO

z = bit width - 1  
 $TC = Q_z \cdot Q_{(z-1)} \cdot Q_{(z-2)} \cdot \dots \cdot Q_0$   
 $CEO = TC \cdot CE$

### Design Entry Method

This design element is only for use in schematics.

### For More Information

- See the [Spartan-3 User Guide](#).
- See the [Spartan-3 Data Sheets](#).

## CC16CLE

Macro: 16-Bit Loadable Cascadable Binary Counter with Clock Enable and Asynchronous Clear

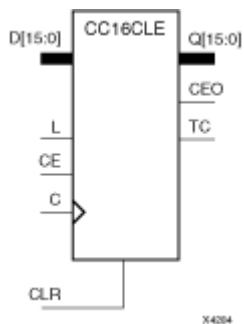

### Introduction

This design element is a synchronously loadable, asynchronously clearable, cascadable binary counter. It is implemented using carry logic with relative location constraints to ensure efficient logic placement. The asynchronous clear (CLR) is the highest priority input. When CLR is High, all other inputs are ignored; the Q outputs, terminal count (TC), and clock enable out (CEO) go to logic level zero, independent of clock transitions. The data on the D inputs is loaded into the counter when the load enable input (L) is High during the Low-to-High clock (C) transition, independent of the state of clock enable (CE). The Q outputs increment when CE is High during the Low-to-High clock transition. The counter ignores clock transitions when CE is Low. The TC output is High when all Q outputs are High.

Create larger counters by connecting the CEO output of each stage to the CE input of the next stage and connecting the C, L, and CLR inputs in parallel. CEO is active (High) when TC and CE are High. The maximum length of the counter is determined by the accumulated CE-to-TC propagation delays versus the clock period. The clock period must be greater than  $n(t_{CE-TC})$ , where  $n$  is the number of stages and the time  $t_{CE-TC}$  is the CE-to-TC propagation delay of each stage. When cascading counters, use the CEO output if the counter uses the CE input or use the TC output if it does not.

This counter is asynchronously cleared, outputs Low, when power is applied. For FPGA devices, power-on conditions are simulated when global set/reset (GSR) is active. GSR defaults to active-High but can be inverted by adding an inverter in front of the GSR input of the appropriate *STARTUP\_architecture* symbol.

### Logic Table

Inputs					Outputs		
CLR	L	CE	C	Dz - D0	Qz - Q0	TC	CEO
1	X	X	X	X	0	0	0
0	1	X	↑	Dn	Dn	TC	CEO
0	0	0	X	X	No change	No change	0
0	0	1	↑	X	Inc	TC	CEO

z = bit width - 1  
 $TC = Qz \cdot Q(z-1) \cdot Q(z-2) \cdot \dots \cdot Q0$   
 $CEO = TC \cdot CE$

### Design Entry Method

This design element is only for use in schematics.



---

## For More Information

- See the [Spartan-3 User Guide](#).
- See the [Spartan-3 Data Sheets](#).

# CC16CLED

Macro: 16-Bit Loadable Cascadable Bidirectional Binary Counter with Clock Enable and Asynchronous Clear

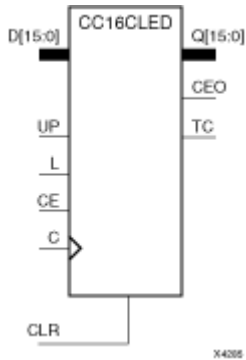

## Introduction

This design element is a synchronously loadable, asynchronously clearable, cascadable, bidirectional binary counter. It is implemented using carry logic with relative location constraints, which assures most efficient logic placement. The asynchronous clear (CLR) is the highest priority input. When CLR is High, all other inputs are ignored; the Q outputs, terminal count (TC), and clock enable out (CEO) go to logic level zero, independent of clock transitions. The data on the D inputs is loaded into the counter when the load enable input (L) is High during the Low-to-High clock (C) transition, independent of the state of clock enable (CE). The Q outputs decrement when CE is High and UP is Low during the Low-to-High clock transition. The Q outputs increment when CE and UP are High. The counter ignores clock transitions when CE is Low.

For counting up, the TC output is High when all Q outputs and UP are High. For counting down, the TC output is High when all Q outputs and UP are Low.

Create larger counters by connecting the CEO output of each stage to the CE input of the next stage and connecting the C, UP, L, and CLR inputs in parallel. CEO is active (High) when TC and CE are High. The maximum length of the counter is determined by the accumulated CE-to-TC propagation delays versus the clock period. The clock period must be greater than  $n \cdot (t_{CE-TC})$ , where  $n$  is the number of stages and the time  $t_{CE-TC}$  is the CE-to-TC propagation delay of each stage. When cascading counters, use the CEO output if the counter uses the CE input or use the TC output if it does not.

This counter is asynchronously cleared, outputs Low, when power is applied. For FPGA devices, power-on conditions are simulated when global set/reset (GSR) is active. GSR defaults to active-High but can be inverted by adding an inverter in front of the GSR input of the appropriate STARTUP\_architecture symbol.

## Logic Table

Inputs						Outputs		
CLR	L	CE	C	UP	Dz - D0	Qz - Q0	TC	CEO
1	X	X	X	X	X	0	0	0
0	1	X	↑	X	Dn	Dn	TC	CEO
0	0	0	X	X	X	No change	No change	0
0	0	1	↑	1	X	Inc	TC	CEO
0	0	1	↑	0	X	Dec	TC	CEO

z = bit width - 1

$$TC = (Qz \cdot Q(z-1) \cdot Q(z-2) \cdot \dots \cdot Q0 \cdot UP) + (Qz \cdot Q(z-1) \cdot Q(z-2) \cdot \dots \cdot Q0 \cdot \overline{UP})$$

$$CEO = TC \cdot CE$$

---

## Design Entry Method

This design element is only for use in schematics.

## For More Information

- See the [Spartan-3 User Guide](#).
- See the [Spartan-3 Data Sheets](#).

## CC16RE

Macro: 16-Bit Cascadable Binary Counter with Clock Enable and Synchronous Reset

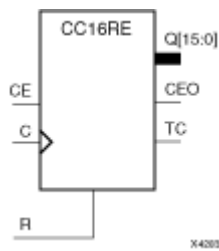

### Introduction

This design element is a synchronous resettable, cascadable binary counter. These counters are implemented using carry logic with relative location constraints to ensure efficient logic placement. The synchronous reset (R) is the highest priority input. When R is High, all other inputs are ignored; the Q outputs, terminal count (TC), and clock enable out (CEO) go to logic level zero on the Low-to-High clock (C) transition. The Q outputs increment when the clock enable input (CE) is High during the Low-to-High clock transition. The counter ignores clock transitions when CE is Low. The TC output is High when all Q outputs and CE are High.

Create larger counters by connecting the CEO output of each stage to the CE input of the next stage and connecting the C and R inputs in parallel. CEO is active (High) when TC and CE are High. The maximum length of the counter is determined by the accumulated CE-to-TC propagation delays versus the clock period. The clock period must be greater than  $n (t_{CE-TC})$ , where  $n$  is the number of stages and the time  $t_{CE-TC}$  is the CE-to-TC propagation delay of each stage. When cascading counters, use the CEO output if the counter uses the CE input or use the TC output if it does not.

This counter is asynchronously cleared, outputs Low, when power is applied. For FPGA devices, power-on conditions are simulated when global set/reset (GSR) is active. GSR defaults to active-High but can be inverted by adding an inverter in front of the GSR input of the appropriate `STARTUP_architecture` symbol.

### Logic Table

Inputs			Outputs		
R	CE	C	Qz-Q0	TC	CEO
1	X	↑	0	0	0
0	0	X	No change	No change	0
0	1	↑	Inc	TC	CEO

$z = \text{bit width} - 1$   
 $TC = Q_z \cdot Q_{(z-1)} \cdot Q_{(z-2)} \cdot \dots \cdot Q_0$   
 $CEO = TC \cdot CE$

### Design Entry Method

This design element is only for use in schematics.

### For More Information

- See the [Spartan-3 User Guide](#).
- See the [Spartan-3 Data Sheets](#).

## CC8CE

Macro: 8-Bit Cascadable Binary Counter with Clock Enable and Asynchronous Clear

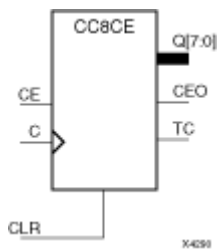

### Introduction

This design element is an asynchronously clearable, cascadable binary counter. It is implemented using carry logic with relative location constraints to ensure efficient logic placement. The asynchronous clear (CLR) is the highest priority input. When CLR is High, all other inputs are ignored; the Q outputs, terminal count (TC), and clock enable out (CEO) go to logic level zero, independent of clock transitions. The Q outputs increment when the clock enable input (CE) is High during the Low-to-High clock (C) transition. The counter ignores clock transitions when CE is Low. The TC output is High when all Q outputs are High.

Create larger counters by connecting the CEO output of each stage to the CE input of the next stage and connecting the C and CLR inputs in parallel. CEO is active (High) when TC and CE are High. The maximum length of the counter is determined by the accumulated CE-to-TC propagation delays versus the clock period. The clock period must be greater than  $n(t_{CE-TC})$ , where  $n$  is the number of stages and the time  $t_{CE-TC}$  is the CE-to-TC propagation delay of each stage. When cascading counters, use the CEO output if the counter uses the CE input or use the TC output if it does not.

This counter is asynchronously cleared, outputs Low, when power is applied. For FPGA devices, power-on conditions are simulated when global set/reset (GSR) is active. GSR defaults to active-High but can be inverted by adding an inverter in front of the GSR input of the appropriate `STARTUP_architecture` symbol.

### Logic Table

Inputs			Outputs		
CLR	CE	C	Q <sub>z</sub> -Q <sub>0</sub>	TC	CEO
1	X	X	0	0	0
0	0	X	No change	No change	0
0	1	↑	Inc	TC	CEO

$z = \text{bit width} - 1$   
 $TC = Q_z \cdot Q_{(z-1)} \cdot Q_{(z-2)} \cdot \dots \cdot Q_0$   
 $CEO = TC \cdot CE$

### Design Entry Method

This design element is only for use in schematics.

### For More Information

- See the [Spartan-3 User Guide](#).
- See the [Spartan-3 Data Sheets](#).

# CC8CLE

Macro: 8-Bit Loadable Cascadable Binary Counter with Clock Enable and Asynchronous Clear

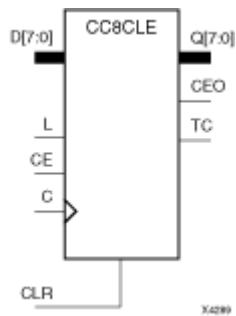

## Introduction

This design element is a synchronously loadable, asynchronously clearable, cascadable binary counter. It is implemented using carry logic with relative location constraints to ensure efficient logic placement. The asynchronous clear (CLR) is the highest priority input. When CLR is High, all other inputs are ignored; the Q outputs, terminal count (TC), and clock enable out (CEO) go to logic level zero, independent of clock transitions. The data on the D inputs is loaded into the counter when the load enable input (L) is High during the Low-to-High clock (C) transition, independent of the state of clock enable (CE). The Q outputs increment when CE is High during the Low-to-High clock transition. The counter ignores clock transitions when CE is Low. The TC output is High when all Q outputs are High.

Create larger counters by connecting the CEO output of each stage to the CE input of the next stage and connecting the C, L, and CLR inputs in parallel. CEO is active (High) when TC and CE are High. The maximum length of the counter is determined by the accumulated CE-to-TC propagation delays versus the clock period. The clock period must be greater than  $n(t_{CE-TC})$ , where  $n$  is the number of stages and the time  $t_{CE-TC}$  is the CE-to-TC propagation delay of each stage. When cascading counters, use the CEO output if the counter uses the CE input or use the TC output if it does not.

This counter is asynchronously cleared, outputs Low, when power is applied. For FPGA devices, power-on conditions are simulated when global set/reset (GSR) is active. GSR defaults to active-High but can be inverted by adding an inverter in front of the GSR input of the appropriate `STARTUP_architecture` symbol.

## Logic Table

Inputs					Outputs		
CLR	L	CE	C	D <sub>z</sub> - D <sub>0</sub>	Q <sub>z</sub> - Q <sub>0</sub>	TC	CEO
1	X	X	X	X	0	0	0
0	1	X	↑	D <sub>n</sub>	D <sub>n</sub>	TC	CEO
0	0	0	X	X	No change	No change	0
0	0	1	↑	X	Inc	TC	CEO

z = bit width - 1  
 $TC = Q_z \cdot Q_{(z-1)} \cdot Q_{(z-2)} \cdot \dots \cdot Q_0$   
 $CEO = TC \cdot CE$

## Design Entry Method

This design element is only for use in schematics.

---

## For More Information

- See the [Spartan-3 User Guide](#).
- See the [Spartan-3 Data Sheets](#).

## CC8CLED

Macro: 8-Bit Loadable Cascadable Bidirectional Binary Counter with Clock Enable and Asynchronous Clear

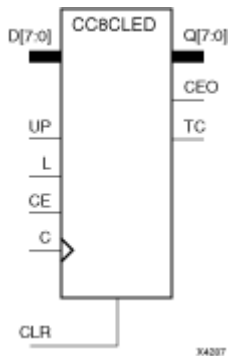

### Introduction

This design element is a synchronously loadable, asynchronously clearable, cascadable, bidirectional binary counter. It is implemented using carry logic with relative location constraints, which assures most efficient logic placement. The asynchronous clear (CLR) is the highest priority input. When CLR is High, all other inputs are ignored; the Q outputs, terminal count (TC), and clock enable out (CEO) go to logic level zero, independent of clock transitions. The data on the D inputs is loaded into the counter when the load enable input (L) is High during the Low-to-High clock (C) transition, independent of the state of clock enable (CE). The Q outputs decrement when CE is High and UP is Low during the Low-to-High clock transition. The Q outputs increment when CE and UP are High. The counter ignores clock transitions when CE is Low.

For counting up, the TC output is High when all Q outputs and UP are High. For counting down, the TC output is High when all Q outputs and UP are Low.

Create larger counters by connecting the CEO output of each stage to the CE input of the next stage and connecting the C, UP, L, and CLR inputs in parallel. CEO is active (High) when TC and CE are High. The maximum length of the counter is determined by the accumulated CE-to-TC propagation delays versus the clock period. The clock period must be greater than  $n(t_{CE-TC})$ , where  $n$  is the number of stages and the time  $t_{CE-TC}$  is the CE-to-TC propagation delay of each stage. When cascading counters, use the CEO output if the counter uses the CE input or use the TC output if it does not.

This counter is asynchronously cleared, outputs Low, when power is applied. For FPGA devices, power-on conditions are simulated when global set/reset (GSR) is active. GSR defaults to active-High but can be inverted by adding an inverter in front of the GSR input of the appropriate `STARTUP_architecture` symbol.

### Logic Table

Inputs						Outputs		
CLR	L	CE	C	UP	D <sub>z</sub> - D <sub>0</sub>	Q <sub>z</sub> - Q <sub>0</sub>	TC	CEO
1	X	X	X	X	X	0	0	0
0	1	X	↑	X	D <sub>n</sub>	D <sub>n</sub>	TC	CEO
0	0	0	X	X	X	No change	No change	0
0	0	1	↑	1	X	Inc	TC	CEO
0	0	1	↑	0	X	Dec	TC	CEO

$z = \text{bit width} - 1$

$$TC = (Q_z \cdot Q_{(z-1)} \cdot Q_{(z-2)} \cdot \dots \cdot Q_0 \cdot UP) + (Q_z \cdot Q_{(z-1)} \cdot Q_{(z-2)} \cdot \dots \cdot Q_0 \cdot \overline{UP})$$

$$CEO = TC \cdot CE$$



---

## Design Entry Method

This design element is only for use in schematics.

## For More Information

- See the [Spartan-3 User Guide](#).
- See the [Spartan-3 Data Sheets](#).

## CC8RE

Macro: 8-Bit Cascadable Binary Counter with Clock Enable and Synchronous Reset

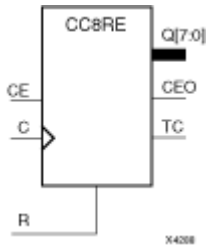

### Introduction

This design element is a synchronous resettable, cascadable binary counter. These counters are implemented using carry logic with relative location constraints to ensure efficient logic placement. The synchronous reset (R) is the highest priority input. When R is High, all other inputs are ignored; the Q outputs, terminal count (TC), and clock enable out (CEO) go to logic level zero on the Low-to-High clock (C) transition. The Q outputs increment when the clock enable input (CE) is High during the Low-to-High clock transition. The counter ignores clock transitions when CE is Low. The TC output is High when all Q outputs and CE are High.

Create larger counters by connecting the CEO output of each stage to the CE input of the next stage and connecting the C and R inputs in parallel. CEO is active (High) when TC and CE are High. The maximum length of the counter is determined by the accumulated CE-to-TC propagation delays versus the clock period. The clock period must be greater than  $n (t_{CE-TC})$ , where  $n$  is the number of stages and the time  $t_{CE-TC}$  is the CE-to-TC propagation delay of each stage. When cascading counters, use the CEO output if the counter uses the CE input or use the TC output if it does not.

This counter is asynchronously cleared, outputs Low, when power is applied. For FPGA devices, power-on conditions are simulated when global set/reset (GSR) is active. GSR defaults to active-High but can be inverted by adding an inverter in front of the GSR input of the appropriate `STARTUP_architecture` symbol.

### Logic Table

Inputs			Outputs		
R	CE	C	Qz-Q0	TC	CEO
1	X	↑	0	0	0
0	0	X	No change	No change	0
0	1	↑	Inc	TC	CEO

$z = \text{bit width} - 1$   
 $TC = Q_z \cdot Q_{(z-1)} \cdot Q_{(z-2)} \cdot \dots \cdot Q_0$   
 $CEO = TC \cdot CE$

### Design Entry Method

This design element is only for use in schematics.

### For More Information

- See the [Spartan-3 User Guide](#).
- See the [Spartan-3 Data Sheets](#).

# CD4CE

Macro: 4-Bit Cascadable BCD Counter with Clock Enable and Asynchronous Clear

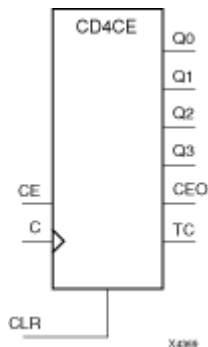

## Introduction

CD4CE is a 4-bit (stage), asynchronous clearable, cascadable binary-coded-decimal (BCD) counter. The asynchronous clear input (CLR) is the highest priority input. When CLR is High, all other inputs are ignored; the Q outputs, terminal count (TC), and clock enable out (CEO) go to logic level zero, independent of clock transitions. The Q outputs increment when clock enable (CE) is High during the Low-to-High clock (C) transition. The counter ignores clock transitions when CE is Low. The TC output is High when Q3 and Q0 are High and Q2 and Q1 are Low.

The counter recovers from any of six possible illegal states and returns to a normal count sequence within two clock cycles for Xilinx® devices, as shown in the following state diagram:

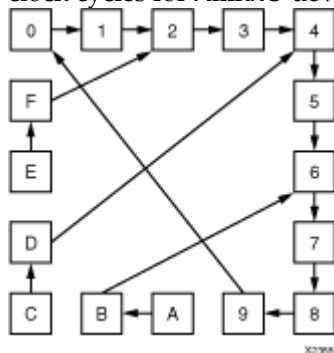

Create larger counters by connecting the CEO output of each stage to the CE input of the next stage and connecting the C and CLR inputs in parallel. CEO is active (High) when TC and CE are High. The maximum length of the counter is determined by the accumulated CE-to-TC propagation delays versus the clock period. The clock period must be greater than  $n(t_{CE-TC})$ , where  $n$  is the number of stages and the time  $t_{CE-TC}$  is the CE-to-TC propagation delay of each stage. When cascading counters, use the CEO output if the counter uses the CE input or use the TC output if it does not.

This counter is asynchronously cleared, outputs Low, when power is applied. For FPGA devices, power-on conditions are simulated when global set/reset (GSR) is active. GSR defaults to active-High but can be inverted by adding an inverter in front of the GSR input of the appropriate STARTUP\_architecture symbol.

## Logic Table

Inputs			Outputs					
CLR	CE	C	Q3	Q2	Q1	Q0	TC	CEO
1	X	X	0	0	0	0	0	0
0	1	↑	Inc	Inc	Inc	Inc	TC	CEO

Inputs			Outputs					
CLR	CE	C	Q3	Q2	Q1	Q0	TC	CEO
0	0	X	No Change	No Change	No Change	No Change	TC	0
0	1	X	1	0	0	1	1	1
$TC = Q3 \cdot !Q2 \cdot !Q1 \cdot Q0$ $CEO = TC \cdot CE$								

## Design Entry Method

This design element is only for use in schematics.

## For More Information

- See the [Spartan-3 User Guide](#).
- See the [Spartan-3 Data Sheets](#).

## CD4CLE

Macro: 4-Bit Loadable Cascadable BCD Counter with Clock Enable and Asynchronous Clear

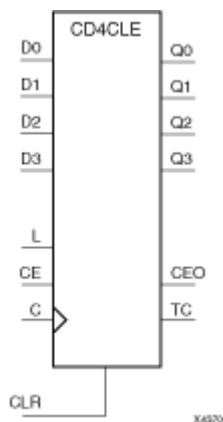

### Introduction

CD4CLE is a 4-bit (stage), synchronously loadable, asynchronously clearable, binary-coded-decimal (BCD) counter. The asynchronous clear input (CLR) is the highest priority input. When (CLR) is High, all other inputs are ignored; the (Q) outputs, terminal count (TC), and clock enable out (CEO) go to logic level zero, independent of clock transitions. The data on the (D) inputs is loaded into the counter when the load enable input (L) is High during the Low-to-High clock (C) transition. The (Q) outputs increment when clock enable input (CE) is High during the Low-to-High clock transition. The counter ignores clock transitions when (CE) is Low. The (TC) output is High when Q3 and Q0 are High and Q2 and Q1 are Low.

The counter recovers from any of six possible illegal states and returns to a normal count sequence within two clock cycles for Xilinx® devices, as shown in the following state diagram:

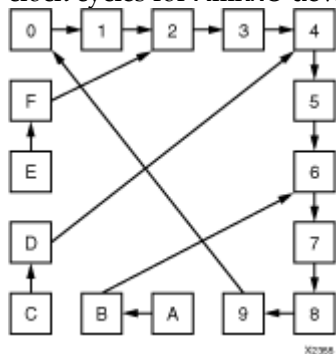

Create larger counters by connecting the CEO output of each stage to the CE input of the next stage and connecting the C, L, and CLR inputs in parallel. CEO is active (High) when TC and CE are High. The maximum length of the counter is determined by the accumulated CE-to-TC propagation delays versus the clock period. The clock period must be greater than  $n(t_{CE-TC})$ , where  $n$  is the number of stages and the time  $t_{CE-TC}$  is the CE-to-TC propagation delay of each stage. When cascading counters, use the CEO output if the counter uses the CE input or use the TC output if it does not.

This counter is asynchronously cleared, outputs Low, when power is applied. For FPGA devices, power-on conditions are simulated when global set/reset (GSR) is active. GSR defaults to active-High but can be inverted by adding an inverter in front of the GSR input of the appropriate `STARTUP_architecture` symbol.

## Logic Table

Inputs					Outputs					
CLR	L	CE	D3 – D0	C	Q3	Q2	Q1	Q0	TC	CEO
1	X	X	X	X	0	0	0	0	0	0
0	1	X	D3 – D0	↑	D3	D2	D1	D0	TC	CEO
0	0	1	X	↑	Inc	Inc	Inc	Inc	TC	CEO
0	0	0	X	X	No Change	No Change	No Change	No Change	TC	0
0	0	1	X	X	1	0	0	1	1	1
$TC = Q3 \cdot !Q2 \cdot !Q1 \cdot Q0$ $CEO = TC \cdot CE$										

## Design Entry Method

This design element is only for use in schematics.

## For More Information

- See the [Spartan-3 User Guide](#).
- See the [Spartan-3 Data Sheets](#).

# CD4RE

Macro: 4-Bit Cascadable BCD Counter with Clock Enable and Synchronous Reset

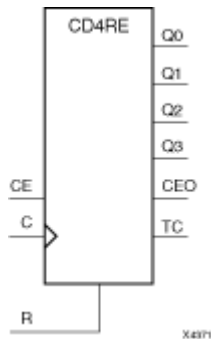

## Introduction

CD4RE is a 4-bit (stage), synchronous resettable, cascadable binary-coded-decimal (BCD) counter. The synchronous reset input (R) is the highest priority input. When (R) is High, all other inputs are ignored; the (Q) outputs, terminal count (TC), and clock enable out (CEO) go to logic level zero on the Low-to-High clock (C) transition. The (Q) outputs increment when the clock enable input (CE) is High during the Low-to-High clock transition. The counter ignores clock transitions when (CE) is Low. The (TC) output is High when Q3 and Q0 are High and Q2 and Q1 are Low.

The counter recovers from any of six possible illegal states and returns to a normal count sequence within two clock cycles for Xilinx® devices, as shown in the following state diagram:

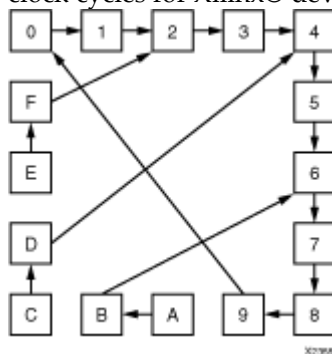

Create larger counters by connecting the CEO output of each stage to the CE input of the next stage and connecting the C and R inputs in parallel. CEO is active (High) when TC and CE are High. The maximum length of the counter is determined by the accumulated CE-to-TC propagation delays versus the clock period. The clock period must be greater than  $n(t_{CE-TC})$ , where  $n$  is the number of stages and the time  $t_{CE-TC}$  is the CE-to-TC propagation delay of each stage. When cascading counters, use the CEO output if the counter uses the CE input or use the TC output if it does not.

This counter is asynchronously cleared, outputs Low, when power is applied. For FPGA devices, power-on conditions are simulated when global set/reset (GSR) is active. GSR defaults to active-High but can be inverted by adding an inverter in front of the GSR input of the appropriate STARTUP\_architecture symbol.

## Logic Table

Inputs			Outputs					
R	CE	C	Q3	Q2	Q1	Q0	TC	CEO
1	X	↑	0	0	0	0	0	0
0	1	↑	Inc	Inc	Inc	Inc	TC	CEO

Inputs			Outputs					
R	CE	C	Q3	Q2	Q1	Q0	TC	CEO
0	0	X	No Change	No Change	No Change	No Change	TC	0
0	1	X	1	0	0	1	1	1
$TC = Q3 \cdot !Q2 \cdot !Q1 \cdot Q0$ $CEO = TC \cdot CE$								

## Design Entry Method

This design element is only for use in schematics.

## For More Information

- See the [Spartan-3 User Guide](#).
- See the [Spartan-3 Data Sheets](#).



## CD4RLE

Macro: 4-Bit Loadable Cascadable BCD Counter with Clock Enable and Synchronous Reset

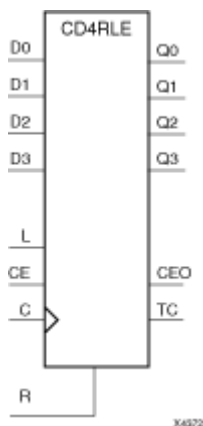

### Introduction

CD4RLE is a 4-bit (stage), synchronous loadable, resettable, binary-coded-decimal (BCD) counter. The synchronous reset input (R) is the highest priority input. When R is High, all other inputs are ignored; the Q outputs, terminal count (TC), and clock enable out (CEO) go to logic level zero on the Low-to-High clock transitions. The data on the D inputs is loaded into the counter when the load enable input (L) is High during the Low-to-High clock (C) transition. The Q outputs increment when the clock enable input (CE) is High during the Low-to-High clock transition. The counter ignores clock transitions when CE is Low. The TC output is High when Q3 and Q0 are High and Q2 and Q1 are Low.

The counter recovers from any of six possible illegal states and returns to a normal count sequence within two clock cycles for Xilinx® devices, as shown in the following state diagram:

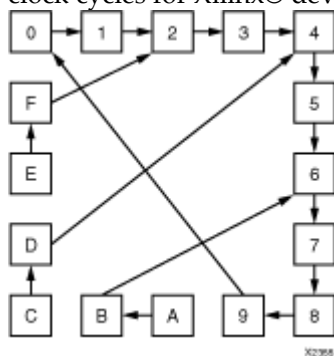

Create larger counters by connecting the CEO output of each stage to the CE input of the next stage and connecting the C, L, and R inputs in parallel. CEO is active (High) when TC and CE are High. The maximum length of the counter is determined by the accumulated CE-to-TC propagation delays versus the clock period. The clock period must be greater than  $n(t_{CE-TC})$ , where  $n$  is the number of stages and the time  $t_{CE-TC}$  is the CE-to-TC propagation delay of each stage. When cascading counters, use the CEO output if the counter uses the CE input or use the TC output if it does not.

This counter is asynchronously cleared, outputs Low, when power is applied. For FPGA devices, power-on conditions are simulated when global set/reset (GSR) is active. GSR defaults to active-High but can be inverted by adding an inverter in front of the GSR input of the appropriate `STARTUP_architecture` symbol.

## Logic Table

Inputs					Outputs					
R	L	CE	D3 – D0	C	Q3	Q2	Q1	Q0	TC	CEO
1	X	X	X	↑	0	0	0	0	0	0
0	1	X	D3 – D0	↑	D3	D	D	D0	TC	CEO
0	0	1	X	↑	Inc	Inc	Inc	Inc	TC	CEO
0	0	0	X	X	No Change	No Change	No Change	No Change	TC	0
0	0	1	X	X	1	0	0	1	1	1
$TC = Q3 \cdot !Q2 \cdot !Q1 \cdot Q0$ $CEO = TC \cdot CE$										

## Design Entry Method

This design element is only for use in schematics.

## For More Information

- See the [Spartan-3 User Guide](#).
- See the [Spartan-3 Data Sheets](#).

## CJ4CE

Macro: 4-Bit Johnson Counter with Clock Enable and Asynchronous Clear

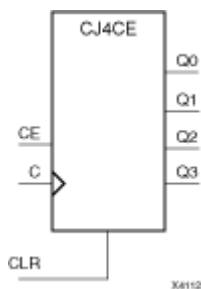

### Introduction

This design element is a clearable Johnson/shift counter. The asynchronous clear (CLR) input, when High, overrides all other inputs and forces the data (Q) outputs to logic level zero, independent of clock (C) transitions. The counter increments (shifts Q0 to Q1, Q1 to Q2, and so forth) when the clock enable input (CE) is High during the Low-to-High clock transition. Clock transitions are ignored when (CE) is Low.

The Q3 output is inverted and fed back to input Q0 to provide continuous counting operation.

This counter is asynchronously cleared, outputs Low, when power is applied. For FPGA devices, power-on conditions are simulated when global set/reset (GSR) is active. GSR defaults to active-High but can be inverted by adding an inverter in front of the GSR input of the appropriate `STARTUP_architecture` symbol.

### Logic Table

Inputs			Outputs	
CLR	CE	C	Q0	Q1 through Q3
1	X	X	0	0
0	0	X	No change	No change
0	1	↑	!q3	q0 through q2

q = state of referenced output one setup time prior to active clock transition

### Design Entry Method

This design element is only for use in schematics.

### For More Information

- See the [Spartan-3 User Guide](#).
- See the [Spartan-3 Data Sheets](#).

## CJ4RE

Macro: 4-Bit Johnson Counter with Clock Enable and Synchronous Reset

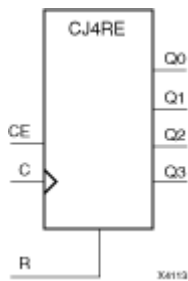

### Introduction

This design element is a resettable Johnson/shift counter. The synchronous reset (R) input, when High, overrides all other inputs and forces the data (Q) outputs to logic level zero during the Low-to-High clock (C) transition. The counter increments (shifts Q0 to Q1, Q1 to Q2, and so forth) when the clock enable input (CE) is High during the Low-to-High clock transition. Clock transitions are ignored when CE is Low.

The Q3 output is inverted and fed back to input Q0 to provide continuous counting operation.

This counter is asynchronously cleared, outputs Low, when power is applied. For FPGA devices, power-on conditions are simulated when global set/reset (GSR) is active. GSR defaults to active-High but can be inverted by adding an inverter in front of the GSR input of the appropriate `STARTUP_architecture` symbol.

### Logic Table

Inputs			Outputs	
R	CE	C	Q0	Q1 through Q3
1	X	↑	0	0
0	0	X	No change	No change
0	1	↑	!q3	q0 through q2

q = state of referenced output one setup time prior to active clock transition

### Design Entry Method

This design element is only for use in schematics.

### For More Information

- See the [Spartan-3 User Guide](#).
- See the [Spartan-3 Data Sheets](#).

## CJ5CE

Macro: 5-Bit Johnson Counter with Clock Enable and Asynchronous Clear

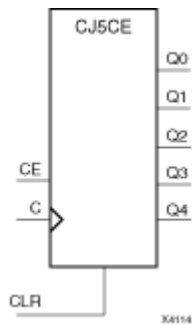

### Introduction

This design element is a clearable Johnson/shift counter. The asynchronous clear (CLR) input, when High, overrides all other inputs and forces the data (Q) outputs to logic level zero, independent of clock (C) transitions. The counter increments (shifts Q0 to Q1, Q1 to Q2, and so forth) when the clock enable input (CE) is High during the Low-to-High clock transition. Clock transitions are ignored when (CE) is Low.

The Q4 output is inverted and fed back to input Q0 to provide continuous counting operation.

This counter is asynchronously cleared, outputs Low, when power is applied. For FPGA devices, power-on conditions are simulated when global set/reset (GSR) is active. GSR defaults to active-High but can be inverted by adding an inverter in front of the GSR input of the appropriate `STARTUP_architecture` symbol.

### Logic Table

Inputs			Outputs	
CLR	CE	C	Q0	Q1 through Q4
1	X	X	0	0
0	0	X	No change	No change
0	1	↑	!q4	q0 through q3

q = state of referenced output one setup time prior to active clock transition

### Design Entry Method

This design element is only for use in schematics.

### For More Information

- See the [Spartan-3 User Guide](#).
- See the [Spartan-3 Data Sheets](#).

## CJ5RE

Macro: 5-Bit Johnson Counter with Clock Enable and Synchronous Reset

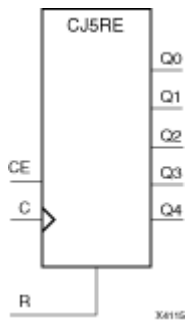

### Introduction

This design element is a resettable Johnson/shift counter. The synchronous reset (R) input, when High, overrides all other inputs and forces the data (Q) outputs to logic level zero during the Low-to-High clock (C) transition. The counter increments (shifts Q0 to Q1, Q1 to Q2, and so forth) when the clock enable input (CE) is High during the Low-to-High clock transition. Clock transitions are ignored when CE is Low.

The Q4 output is inverted and fed back to input Q0 to provide continuous counting operation.

This counter is asynchronously cleared, outputs Low, when power is applied. For FPGA devices, power-on conditions are simulated when global set/reset (GSR) is active. GSR defaults to active-High but can be inverted by adding an inverter in front of the GSR input of the appropriate `STARTUP_architecture` symbol.

### Logic Table

Inputs			Outputs	
R	CE	C	Q0	Q1 through Q4
1	X	↑	0	0
0	0	X	No change	No change
0	1	↑	!q4	q0 through q3

q = state of referenced output one setup time prior to active clock transition

### Design Entry Method

This design element is only for use in schematics.

### For More Information

- See the [Spartan-3 User Guide](#).
- See the [Spartan-3 Data Sheets](#).

## CJ8CE

Macro: 8-Bit Johnson Counter with Clock Enable and Asynchronous Clear

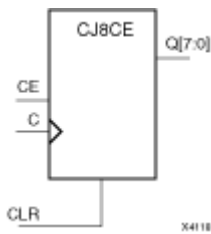

### Introduction

This design element is a clearable Johnson/shift counter. The asynchronous clear (CLR) input, when High, overrides all other inputs and forces the data (Q) outputs to logic level zero, independent of clock (C) transitions. The counter increments (shifts Q0 to Q1, Q1 to Q2, and so forth) when the clock enable input (CE) is High during the Low-to-High clock transition. Clock transitions are ignored when (CE) is Low.

The Q7 output is inverted and fed back to input Q0 to provide continuous counting operation.

This counter is asynchronously cleared, outputs Low, when power is applied. For FPGA devices, power-on conditions are simulated when global set/reset (GSR) is active. GSR defaults to active-High but can be inverted by adding an inverter in front of the GSR input of the appropriate *STARTUP\_architecture* symbol.

### Logic Table

Inputs			Outputs	
CLR	CE	C	Q0	Q1 through Q8
1	X	X	0	0
0	0	X	No change	No change
0	1	↑	!q7	q0 through q7

q = state of referenced output one setup time prior to active clock transition

### Design Entry Method

This design element is only for use in schematics.

### For More Information

- See the [Spartan-3 User Guide](#).
- See the [Spartan-3 Data Sheets](#).

## CJ8RE

Macro: 8-Bit Johnson Counter with Clock Enable and Synchronous Reset

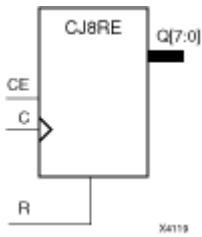

### Introduction

This design element is a resettable Johnson/shift counter. The synchronous reset (R) input, when High, overrides all other inputs and forces the data (Q) outputs to logic level zero during the Low-to-High clock (C) transition. The counter increments (shifts Q0 to Q1, Q1 to Q2, and so forth) when the clock enable input (CE) is High during the Low-to-High clock transition. Clock transitions are ignored when CE is Low.

The Q7 output is inverted and fed back to input Q0 to provide continuous counting operation.

This counter is asynchronously cleared, outputs Low, when power is applied. For FPGA devices, power-on conditions are simulated when global set/reset (GSR) is active. GSR defaults to active-High but can be inverted by adding an inverter in front of the GSR input of the appropriate *STARTUP\_architecture* symbol.

### Logic Table

Inputs			Outputs	
R	CE	C	Q0	Q1 through Q7
1	X	↑	0	0
0	0	X	No change	No change
0	1	↑	!q7	q0 through q6

q = state of referenced output one setup time prior to active clock transition

### Design Entry Method

This design element is only for use in schematics.

### For More Information

- See the [Spartan-3 User Guide](#).
- See the [Spartan-3 Data Sheets](#).



## COMP16

Macro: 16-Bit Identity Comparator

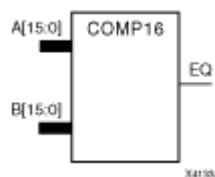

### Introduction

This design element is a 16-bit identity comparator. The equal output (EQ) is high when A15 – A0 and B15 – B0 are equal.

Equality is determined by a bit comparison of the two words. When any two of the corresponding bits from each word are not the same, the EQ output is Low.

### Design Entry Method

This design element is only for use in schematics.

### For More Information

- See the [Spartan-3 User Guide](#).
- See the [Spartan-3 Data Sheets](#).

## COMP2

Macro: 2-Bit Identity Comparator

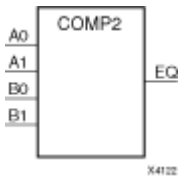

### Introduction

This design element is a 2-bit identity comparator. The equal output (EQ) is High when the two words A1 – A0 and B1 – B0 are equal.

Equality is determined by a bit comparison of the two words. When any two of the corresponding bits from each word are not the same, the EQ output is Low.

### Design Entry Method

This design element is only for use in schematics.

### For More Information

- See the [Spartan-3 User Guide](#).
- See the [Spartan-3 Data Sheets](#).

## COMP4

Macro: 4-Bit Identity Comparator

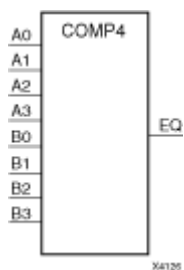

### Introduction

This design element is a 4-bit identity comparator. The equal output (EQ) is high when A3 – A0 and B3 – B0 are equal.

Equality is determined by a bit comparison of the two words. When any two of the corresponding bits from each word are not the same, the EQ output is Low.

### Design Entry Method

This design element is only for use in schematics.

### For More Information

- See the [Spartan-3 User Guide](#).
- See the [Spartan-3 Data Sheets](#).

## COMP8

Macro: 8-Bit Identity Comparator

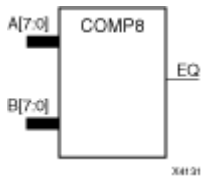

### Introduction

This design element is an 8-bit identity comparator. The equal output (EQ) is high when A7 – A0 and B7 – B0 are equal.

Equality is determined by a bit comparison of the two words. When any two of the corresponding bits from each word are not the same, the EQ output is Low.

### Design Entry Method

This design element is only for use in schematics.

### For More Information

- See the [Spartan-3 User Guide](#).
- See the [Spartan-3 Data Sheets](#).

## COMP16

Macro: 16-Bit Magnitude Comparator

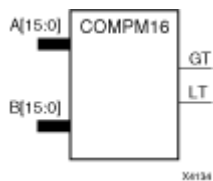

### Introduction

This design element is a 16-bit magnitude comparator that compare two positive Binary-weighted words. It compares A15 – A0 and B15 – B0, where A15 and B15 are the most significant bits.

The greater-than output (GT) is High when  $A > B$ , and the less-than output (LT) is High when  $A < B$ . When the two words are equal, both GT and LT are Low. Equality can be measured with this macro by comparing both outputs with a NOR gate.

### Logic Table

Inputs								Outputs	
A7, B7	A6, B6	A5, B5	A4, B4	A3, B3	A2, B2	A1, B1	A0, B0	GT	LT
A7>B7	X	X	X	X	X	X	X	1	0
A7<B7	X	X	X	X	X	X	X	0	1
A7=B7	A6>B6	X	X	X	X	X	X	1	0
A7=B7	A6<B6	X	X	X	X	X	X	0	1
A7=B7	A6=B6	A5>B5	X	X	X	X	X	1	0
A7=B7	A6=B6	A5<B5	X	X	X	X	X	0	1
A7=B7	A6=B6	A5=B5	A4>B4	X	X	X	X	1	0
A7=B7	A6=B6	A5=B5	A4<B4	X	X	X	X	0	1
A7=B7	A6=B6	A5=B5	A4=B4	A3>B3	X	X	X	1	0
A7=B7	A6=B6	A5=B5	A4=B4	A3<B3	X	X	X	0	1
A7=B7	A6=B6	A5=B5	A4=B4	A3=B3	A2>B2	X	X	1	0
A7=B7	A6=B6	A5=B5	A4=B4	A3=B3	A2<B2	X	X	0	1
A7=B7	A6=B6	A5=B5	A4=B4	A3=B3	A2=B2	A1>B1	X	1	0
A7=B7	A6=B6	A5=B5	A4=B4	A3=B3	A2=B2	A1<B1	X	0	1
A7=B7	A6=B6	A5=B5	A4=B4	A3=B3	A2=B2	A1=B1	A0>B0	1	0
A7=B7	A6=B6	A5=B5	A4=B4	A3=B3	A2=B2	A1=B1	A0<B0	0	1
A7=B7	A6=B6	A5=B5	A4=B4	A3=B3	A2=B2	A1=B1	A0=B0	0	0

### Design Entry Method

This design element is only for use in schematics.

## For More Information

- See the [Spartan-3 User Guide](#).
- See the [Spartan-3 Data Sheets](#).

## COMPM2

Macro: 2-Bit Magnitude Comparator

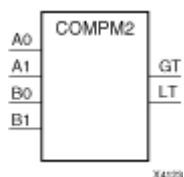

### Introduction

This design element is a 2-bit magnitude comparator that compare two positive Binary-weighted words. It compares  $A1 - A0$  and  $B1 - B0$ , where A1 and B1 are the most significant bits.

The greater-than output (GT) is High when  $A > B$ , and the less-than output (LT) is High when  $A < B$ . When the two words are equal, both GT and LT are Low. Equality can be measured with this macro by comparing both outputs with a NOR gate.

### Logic Table

Inputs				Outputs	
A1	B1	A0	B0	GT	LT
0	0	0	0	0	0
0	0	1	0	1	0
0	0	0	1	0	1
0	0	1	1	0	0
1	1	0	0	0	0
1	1	1	0	1	0
1	1	0	1	0	1
1	1	1	1	0	0
1	0	X	X	1	0
0	1	X	X	0	1

### Design Entry Method

This design element is only for use in schematics.

### For More Information

- See the [Spartan-3 User Guide](#).
- See the [Spartan-3 Data Sheets](#).

# COMP4

Macro: 4-Bit Magnitude Comparator

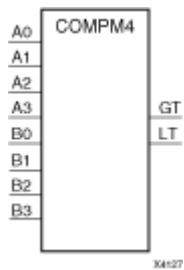

## Introduction

This design element is a 4-bit magnitude comparator that compare two positive Binary-weighted words. It compares A3 – A0 and B3 – B0, where A3 and B3 are the most significant bits.

The greater-than output (GT) is High when  $A > B$ , and the less-than output (LT) is High when  $A < B$ . When the two words are equal, both GT and LT are Low. Equality can be measured with this macro by comparing both outputs with a NOR gate.

## Logic Table

Inputs				Outputs	
A3, B3	A2, B2	A1, B1	A0, B0	GT	LT
A3>B3	X	X	X	1	0
A3<B3	X	X	X	0	1
A3=B3	A2>B2	X	X	1	0
A3=B3	A2<B2	X	X	0	1
A3=B3	A2=B2	A1>B1	X	1	0
A3=B3	A2=B2	A1<B1	X	0	1
A3=B3	A2=A2	A1=B1	A0>B0	1	0
A3=B3	A2=B2	A1=B1	A0<B0	0	1
A3=B3	A2=B2	A1=B1	A0=B0	0	0

## Design Entry Method

This design element is only for use in schematics.

## For More Information

- See the [Spartan-3 User Guide](#).
- See the [Spartan-3 Data Sheets](#).



## COMP8

Macro: 8-Bit Magnitude Comparator

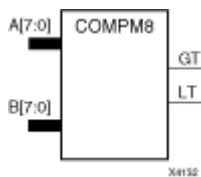

### Introduction

This design element is an 8-bit magnitude comparator that compare two positive Binary-weighted words. It compares  $A_7 - A_0$  and  $B_7 - B_0$ , where  $A_7$  and  $B_7$  are the most significant bits.

The greater-than output (GT) is High when  $A > B$ , and the less-than output (LT) is High when  $A < B$ . When the two words are equal, both GT and LT are Low. Equality can be measured with this macro by comparing both outputs with a NOR gate.

### Logic Table

Inputs								Outputs	
A7, B7	A6, B6	A5, B5	A4, B4	A3, B3	A2, B2	A1, B1	A0, B0	GT	LT
A7>B7	X	X	X	X	X	X	X	1	0
A7<B7	X	X	X	X	X	X	X	0	1
A7=B7	A6>B6	X	X	X	X	X	X	1	0
A7=B7	A6<B6	X	X	X	X	X	X	0	1
A7=B7	A6=B6	A5>B5	X	X	X	X	X	1	0
A7=B7	A6=B6	A5<B5	X	X	X	X	X	0	1
A7=B7	A6=B6	A5=B5	A4>B4	X	X	X	X	1	0
A7=B7	A6=B6	A5=B5	A4<B4	X	X	X	X	0	1
A7=B7	A6=B6	A5=B5	A4=B4	A3>B3	X	X	X	1	0
A7=B7	A6=B6	A5=B5	A4=B4	A3<B3	X	X	X	0	1
A7=B7	A6=B6	A5=B5	A4=B4	A3=B3	A2>B2	X	X	1	0
A7=B7	A6=B6	A5=B5	A4=B4	A3=B3	A2<B2	X	X	0	1
A7=B7	A6=B6	A5=B5	A4=B4	A3=B3	A2=B2	A1>B1	X	1	0
A7=B7	A6=B6	A5=B5	A4=B4	A3=B3	A2=B2	A1<B1	X	0	1
A7=B7	A6=B6	A5=B5	A4=B4	A3=B3	A2=B2	A1=B1	A0>B0	1	0
A7=B7	A6=B6	A5=B5	A4=B4	A3=B3	A2=B2	A1=B1	A0<B0	0	1
A7=B7	A6=B6	A5=B5	A4=B4	A3=B3	A2=B2	A1=B1	A0=B0	0	0

### Design Entry Method

This design element is only for use in schematics.

## For More Information

- See the [Spartan-3 User Guide](#).
- See the [Spartan-3 Data Sheets](#).

## COMP16

Macro: 16-Bit Magnitude Comparator

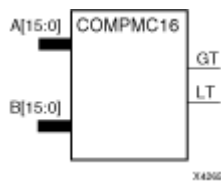

### Introduction

This design element is a 16-bit, magnitude comparator that compares two positive Binary weighted words A15 – A0 and B15 – B0, where A15 and B15 are the most significant bits.

This comparator is implemented using carry logic with relative location constraints to ensure efficient logic placement.

The greater-than output (GT) is High when  $A > B$ , and the less-than output (LT) is High when  $A < B$ . When the two words are equal, both GT and LT are Low. Equality can be flagged with this macro by connecting both outputs to a NOR gate.

### Logic Table

Inputs								Outputs	
A7, B7	A6, B6	A5, B5	A4, B4	A3, B3	A2, B2	A1, B1	A0, B0	GT	LT
A7>B7	X	X	X	X	X	X	X	1	0
A7<B7	X	X	X	X	X	X	X	0	1
A7=B7	A6>B6	X	X	X	X	X	X	1	0
A7=B7	A6<B6	X	X	X	X	X	X	0	1
A7=B7	A6=B6	A5>B5	X	X	X	X	X	1	0
A7=B7	A6=B6	A5<B5	X	X	X	X	X	0	1
A7=B7	A6=B6	A5=B5	A4>B4	X	X	X	X	1	0
A7=B7	A6=B6	A5=B5	A4<B4	X	X	X	X	0	1
A7=B7	A6=B6	A5=B5	A4=B4	A3>B3	X	X	X	1	0
A7=B7	A6=B6	A5=B5	A4=B4	A3<B3	X	X	X	0	1
A7=B7	A6=B6	A5=B5	A4=B4	A3=B3	A2>B2	X	X	1	0
A7=B7	A6=B6	A5=B5	A4=B4	A3=B3	A2<B2	X	X	0	1
A7=B7	A6=B6	A5=B5	A4=B4	A3=B3	A2=B2	A1>B1	X	1	0
A7=B7	A6=B6	A5=B5	A4=B4	A3=B3	A2=B2	A1<B1	X	0	1
A7=B7	A6=B6	A5=B5	A4=B4	A3=B3	A2=B2	A1=B1	A0>B0	1	0
A7=B7	A6=B6	A5=B5	A4=B4	A3=B3	A2=B2	A1=B1	A0<B0	0	1
A7=B7	A6=B6	A5=B5	A4=B4	A3=B3	A2=B2	A1=B1	A0=B0	0	0

### Design Entry Method

This design element is only for use in schematics.

## For More Information

- See the [Spartan-3 User Guide](#).
- See the [Spartan-3 Data Sheets](#).

## COMP8

Macro: 8-Bit Magnitude Comparator

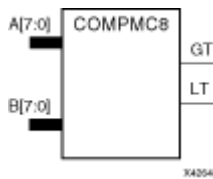

### Introduction

This design element is an 8-bit, magnitude comparator that compares two positive Binaryweighted words A7 – A0 and B7 – B0, where A7 and B7 are the most significant bits.

This comparator is implemented using carry logic with relative location constraints to ensure efficient logic placement.

The greater-than output (GT) is High when  $A > B$ , and the less-than output (LT) is High when  $A < B$ . When the two words are equal, both GT and LT are Low. Equality can be flagged with this macro by connecting both outputs to a NOR gate.

### Logic Table

Inputs								Outputs	
A7, B7	A6, B6	A5, B5	A4, B4	A3, B3	A2, B2	A1, B1	A0, B0	GT	LT
A7>B7	X	X	X	X	X	X	X	1	0
A7<B7	X	X	X	X	X	X	X	0	1
A7=B7	A6>B6	X	X	X	X	X	X	1	0
A7=B7	A6<B6	X	X	X	X	X	X	0	1
A7=B7	A6=B6	A5>B5	X	X	X	X	X	1	0
A7=B7	A6=B6	A5<B5	X	X	X	X	X	0	1
A7=B7	A6=B6	A5=B5	A4>B4	X	X	X	X	1	0
A7=B7	A6=B6	A5=B5	A4<B4	X	X	X	X	0	1
A7=B7	A6=B6	A5=B5	A4=B4	A3>B3	X	X	X	1	0
A7=B7	A6=B6	A5=B5	A4=B4	A3<B3	X	X	X	0	1
A7=B7	A6=B6	A5=B5	A4=B4	A3=B3	A2>B2	X	X	1	0
A7=B7	A6=B6	A5=B5	A4=B4	A3=B3	A2<B2	X	X	0	1
A7=B7	A6=B6	A5=B5	A4=B4	A3=B3	A2=B2	A1>B1	X	1	0
A7=B7	A6=B6	A5=B5	A4=B4	A3=B3	A2=B2	A1<B1	X	0	1
A7=B7	A6=B6	A5=B5	A4=B4	A3=B3	A2=B2	A1=B1	A0>B0	1	0
A7=B7	A6=B6	A5=B5	A4=B4	A3=B3	A2=B2	A1=B1	A0<B0	0	1
A7=B7	A6=B6	A5=B5	A4=B4	A3=B3	A2=B2	A1=B1	A0=B0	0	0

### Design Entry Method

This design element is only for use in schematics.

## For More Information

- See the [Spartan-3 User Guide](#).
- See the [Spartan-3 Data Sheets](#).

## CR16CE

Macro: 16-Bit Negative-Edge Binary Ripple Counter with Clock Enable and Asynchronous Clear

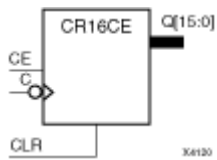

### Introduction

This design element is a 16-bit cascadable, clearable, binary ripple counter with clock enable and asynchronous clear.

Larger counters can be created by connecting the last Q output of the first stage to the clock input of the next stage. CLR and CE inputs are connected in parallel. The clock period is not affected by the overall length of a ripple counter. The overall clock-to-output propagation is  $n(t_{C-Q})$ , where  $n$  is the number of stages and the time  $t_{C-Q}$  is the C-to-Qz propagation delay of each stage.

This counter is asynchronously cleared, outputs Low, when power is applied. For FPGA devices, power-on conditions are simulated when global set/reset (GSR) is active. GSR defaults to active-High but can be inverted by adding an inverter in front of the GSR input of the appropriate `STARTUP_architecture` symbol.

### Logic Table

Inputs			Outputs
CLR	CE	C	Qz - Q0
1	X	X	0
0	0	X	No Change
0	1	∅	Inc

$z = \text{bit width} - 1$

### Design Entry Method

This design element is only for use in schematics.

### For More Information

- See the [Spartan-3 User Guide](#).
- See the [Spartan-3 Data Sheets](#).

## CR8CE

Macro: 8-Bit Negative-Edge Binary Ripple Counter with Clock Enable and Asynchronous Clear

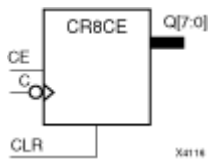

### Introduction

This design element is an 8-bit cascadable, clearable, binary, ripple counter with clock enable and asynchronous clear.

The asynchronous clear (CLR), when High, overrides all other inputs and causes the Q outputs to go to logic level zero. The counter increments when the clock enable input (CE) is High during the High-to-Low clock (C) transition. The counter ignores clock transitions when CE is Low.

Larger counters can be created by connecting the last Q output of the first stage to the clock input of the next stage. CLR and CE inputs are connected in parallel. The clock period is not affected by the overall length of a ripple counter. The overall clock-to-output propagation is  $n(t_{C-Q})$ , where  $n$  is the number of stages and the time  $t_{C-Q}$  is the C-to-Qz propagation delay of each stage.

This counter is asynchronously cleared, outputs Low, when power is applied. For FPGA devices, power-on conditions are simulated when global set/reset (GSR) is active. GSR defaults to active-High but can be inverted by adding an inverter in front of the GSR input of the appropriate `STARTUP_architecture` symbol.

### Logic Table

Inputs			Outputs
CLR	CE	C	Qz - Q0
1	X	X	0
0	0	X	No Change
0	1	∅	Inc

$z = \text{bit width} - 1$

### Design Entry Method

This design element is only for use in schematics.

### For More Information

- See the [Spartan-3 User Guide](#).
- See the [Spartan-3 Data Sheets](#).



## D2\_4E

Macro: 2- to 4-Line Decoder/Demultiplexer with Enable

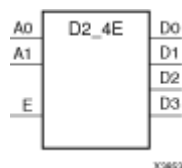

### Introduction

This design element is a decoder/demultiplexer. When the enable (E) input of this element is High, one of four active-High outputs (D3 – D0) is selected with a 2-bit binary address (A1 – A0) input. The non-selected outputs are Low. Also, when the E input is Low, all outputs are Low. In demultiplexer applications, the E input is the data input.

### Logic Table

Inputs			Outputs			
A1	A0	E	D3	D2	D1	D0
X	X	0	0	0	0	0
0	0	1	0	0	0	1
0	1	1	0	0	1	0
1	0	1	0	1	0	0
1	1	1	1	0	0	0

### Design Entry Method

This design element is only for use in schematics.

### For More Information

- See the [Spartan-3 User Guide](#).
- See the [Spartan-3 Data Sheets](#).

## D3\_8E

Macro: 3- to 8-Line Decoder/Demultiplexer with Enable

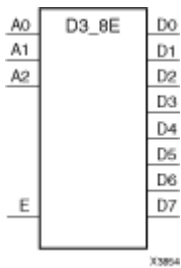

### Introduction

When the enable (E) input of the D3\_8E decoder/demultiplexer is High, one of eight active-High outputs (D7 – D0) is selected with a 3-bit binary address (A2 – A0) input. The non-selected outputs are Low. Also, when the E input is Low, all outputs are Low. In demultiplexer applications, the E input is the data input.

### Logic Table

Inputs				Outputs							
A2	A1	A0	E	D7	D6	D5	D4	D3	D2	D1	D0
X	X	X	0	0	0	0	0	0	0	0	0
0	0	0	1	0	0	0	0	0	0	0	1
0	0	1	1	0	0	0	0	0	0	1	0
0	1	0	1	0	0	0	0	0	1	0	0
0	1	1	1	0	0	0	0	1	0	0	0
1	0	0	1	0	0	0	1	0	0	0	0
1	0	1	1	0	0	1	0	0	0	0	0
1	1	0	1	0	1	0	0	0	0	0	0
1	1	1	1	1	0	0	0	0	0	0	0

### Design Entry Method

This design element is only for use in schematics.

### For More Information

- See the [Spartan-3 User Guide](#).
- See the [Spartan-3 Data Sheets](#).

## D4\_16E

Macro: 4- to 16-Line Decoder/Demultiplexer with Enable

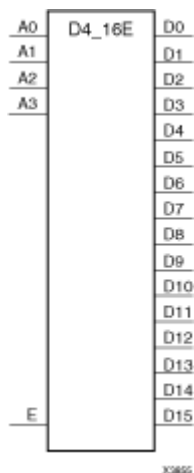

### Introduction

This design element is a decoder/demultiplexer. When the enable (E) input of this design element is High, one of 16 active-High outputs (D15 – D0) is selected with a 4-bit binary address (A3 – A0) input. The non-selected outputs are Low. Also, when the E input is Low, all outputs are Low. In demultiplexer applications, the E input is the data input.

### Design Entry Method

This design element is only for use in schematics.

### For More Information

- See the [Spartan-3 User Guide](#).
- See the [Spartan-3 Data Sheets](#).

## DCM

Primitive: Digital Clock Manager

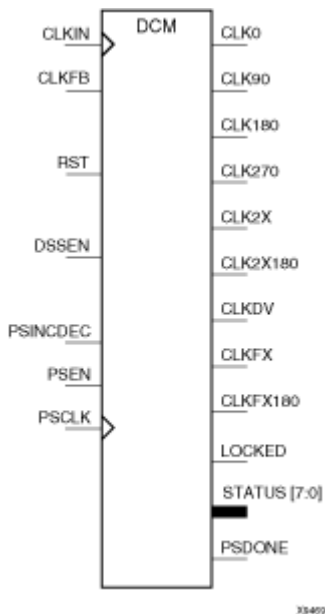

### Introduction

This design element is a digital clock manager that provides multiple functions. It can implement a clock delay locked loop, a digital frequency synthesizer, digital phase shifter, and a digital spread spectrum.

**Note** All unused inputs must be driven Low. The program will automatically tie the inputs Low if they are unused.

#### *Clock Delay Locked Loop (DLL)*

DCM includes a clock delay locked loop used to minimize clock skew for Spartan-3, Virtex-II, Virtex-II Pro, and Virtex-II Pro X devices. DCM synchronizes the clock signal at the feedback clock input (CLKFB) to the clock signal at the input clock (CLKIN). The locked output (LOCKED) is high when the two signals are in phase. The signals are considered to be in phase when their rising edges are within a specified time (ps) of each other.

DCM supports two frequency modes for the DLL. By default, the DLL\_FREQUENCY\_MODE attribute is set to Low and the frequency of the clock signal at the CLKIN input must be in the Low (DLL\_CLKIN\_MIN\_LF to DLL\_CLKIN\_MAX\_LF) frequency range (MHz). In Low frequency mode, the CLK0, CLK90, CLK180, CLK270, CLK2X, CLKDV, and CLK2X180 outputs are available.

For up to and including Virtex-II Pro, you get only CLK0, CLK180, CLKDV, CLKFX and CLKFX180 in the HF mode. In Virtex-4, you get all outputs.

When the DLL\_FREQUENCY\_MODE attribute is set to High, the frequency of the clock signal at the CLKIN input must be in the High (DLL\_CLKIN\_MIN\_HF to DLL\_CLKIN\_MAX\_HF) frequency range (MHz). In High frequency mode, only the CLK0, CLK180, and CLKDV outputs are available.

On-chip synchronization is achieved by connecting the CLKFB input to a point on the global clock network driven by a BUFG, a global clock buffer. The BUFG connected to the CLKFB input of the DCM must be sourced from either the CLK0 or CLK2X outputs of the same DCM. The CLKIN input should be connected to the output of an IBUFG, with the IBUFG input connected to a pad driven by the system clock. Off-chip synchronization is achieved by connecting the CLKFB input to the output of an IBUFG, with the IBUFG input connected to a pad. Either the CLK0 or CLK2X output can be used but not both. The CLK0 or CLK2X must be connected to the input of OBUF, an output buffer. The CLK\_FEEDBACK attribute controls whether the CLK0 output, the default, or the CLK2X output is the source of the CLKFB input.

The duty cycle of the CLK0 output is 50-50 unless the DUTY\_CYCLE\_CORRECTION attribute is set to FALSE, in which case the duty cycle is the same as that of the CLKIN input. The duty cycle of the phase shifted outputs (CLK90, CLK180, and CLK270) is the same as that of the CLK0 output. The duty cycle of the CLK2X, CLK2X180, and CLKDV outputs is 50-50 unless CLKDV\_DIVIDE is a non-integer and the DLL\_FREQUENCY\_MODE is High (see CLKDV\_DIVIDE, in the Constraints Guide for details). The frequency of the CLKDV output is determined by the value assigned to the CLKDV\_DIVIDE attribute

#### DCM Clock Delay Lock Loop Outputs

Output	Description
CLK0	Clock at 1x CLKIN frequency
CLK180	Clock at 1x CLK0 frequency, shifted 180o with regards to CLK0
CLK270*	Clock at 1x CLK0 frequency, shifted 270o with regards to CLK0
CLK2X*	Clock at 2x CLK0 frequency, in phase with CLK0
CLK2X180*	Clock at 2x CLK0 frequency shifted 180o with regards to CLK2X
CLK90*	Clock at 1x CLK0 frequency, shifted 90o with regards to CLK0
CLKDV	Clock at (1/n) x CLK0 frequency, where n=CLKDV_DIVIDE value. CLKDV is in phase with CLK0.
LOCKED	All enabled DCM features locked.

\* The CLK90, CLK270, CLK2X, and CLK2X180 outputs are not available if the DLL\_FREQUENCY\_MODE is set to High.

#### Digital Frequency Synthesizer (DFS)

The CLKFX and CLKFX180 outputs in conjunction with the CLKFX\_MULTIPLY and CLKFX\_DIVIDE attributes provide a frequency synthesizer that can be any multiple or division of CLKIN. CLKFX and CLKIN are in phase every CLKFX\_MULTIPLY cycles of CLKFX and every CLKFX\_DIVIDE cycles of CLKIN when a feedback is provided to the CLKFB input of the DLL. The frequency of CLKFX is defined by the following equation.

$$\text{Frequency}_{\text{CLKFX}} = (\text{CLKFX\_MULTIPLY\_value} / \text{CLKFX\_DIVIDE\_value}) * \text{Frequency}_{\text{CLKIN}}$$

Both the CLKFX or CLKFX180 output can be used simultaneously. CLKFX180 is 1x the CLKFX frequency, shifted 180o with regards to CLKFX. CLKFX and CLKFX180 always have a 50/50 duty cycle. The DFS\_FREQUENCY\_MODE attribute specifies the allowable input clock and output clock frequency ranges. The CLK\_FEEDBACK attribute set to NONE will cause the DCM to be in the Digital Frequency Synthesizer mode. The CLKFX and CLKFX180 will be generated without phase correction with respect to CLKIN. The DSEN input pin for the DCM is no longer recommended for use and should remain unconnected in the design.

#### Digital Phase Shifter (DPS)

The phase shift (skew) between the rising edges of CLKIN and CLKFB may be configured as a fraction of the CLKIN period with the PHASE\_SHIFT attribute. This allows the phase shift to remain constant as ambient conditions change. The CLKOUT\_PHASE\_SHIFT attribute controls the use of the PHASE\_SHIFT value. By default, the CLKOUT\_PHASE\_SHIFT attribute is set to NONE and the PHASE\_SHIFT attribute has no effect.

By creating skew between CLKIN and CLKFB, all DCM output clocks are phase shifted by the amount of the skew. When the CLKOUT\_PHASE\_SHIFT attribute is set to FIXED, the skew set by the PHASE\_SHIFT attribute is used at configuration for the rising edges of CLKIN and CLKFB. The skew remains constant. When the CLKOUT\_PHASE\_SHIFT attribute is set to VARIABLE, the skew set at configuration is used as a starting point and the skew value can be changed dynamically during operation using the PS\* signals. This digital phase shifter feature is controlled by a synchronous interface. The inputs PSEN (phase shift enable) and PSINCDEC (phase shift increment/decrement) are set up to the rising edge of PSCLK (phase shift clock). The PSDONE (phase shift done) output is clocked with the rising edge of PSCLK (the phase shift clock). PSDONE must be connected to implement the complete synchronous interface. The rising-edge skew between CLKIN and CLKFB may be dynamically adjusted after the LOCKED output goes High. The PHASE\_SHIFT attribute value specifies the initial phase shift amount when the device is configured. Then the PHASE\_SHIFT value is changed one unit when PSEN is activated for one period of PSCLK. The PHASE\_SHIFT value is incremented when PSINCDEC is High and decremented when PSINCDEC is Low during the period that PSEN is High.

When the DCM completes an increment or decrement operation, the PSDONE output goes High for a single PSCLK cycle to indicate the operation is complete. At this point the next change may be made. When RST (reset) is High, the PHASE\_SHIFT attribute value is reset to the skew value set at configuration. If CLKOUT\_PHASE\_SHIFT is FIXED or NONE, the PSEN, PSINCDEC, and PSCLK inputs must be tied to GND. The program will automatically tie the inputs to GND if they are not connected by the user.

#### Additional Status Bits

The STATUS output bits return the following information:

Bit	Description
0	Phase Shift Overflow*
1 =  PHASE_SHIFT  > 255	
1	DLL CLKIN stopped**
1 = CLKIN stopped toggling	
2	DLL CLKFX stopped
1 = CLKFX stopped toggling	
3	No
4	No
5	No
6	No
7	No
* Phase Shift Overflow will also go high if the end of the phase shift delay line is reached (see the product data sheet for the most current value of the maximum shifting delay).	
** If only the DFS outputs are used (CLKFX & CLKFX180), this status bit will not go high if CLKIN stops.	

#### LOCKED

When LOCKED is high, all enabled signals are locked.

#### RST

The master reset input (RST) resets DCM to its initial (power-on) state. The signal at the RST input is asynchronous and must be held High for 2ns.

## Design Entry Method

This design element can be used in schematics.

## Available Attributes

Attribute	Type	Allowed Values	Default	Description
SIM_MODE	String	"SAFE" or "FAST"	"SAFE"	This is a simulation only attribute. It will direct the simulation model to run in performance-oriented mode when set to "FAST." Please see the <i>Synthesis and Simulation Design Guide</i> for more information.

## For More Information

- See the [Spartan-3 User Guide](#).
- See the [Spartan-3 Data Sheets](#).

## DEC\_CC16

Macro: 16-Bit Active Low Decoder

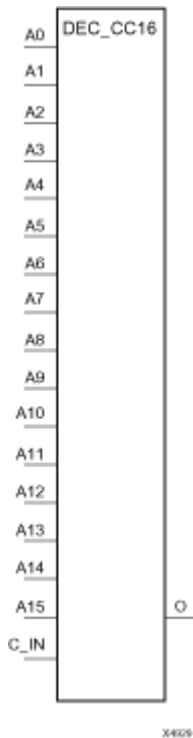

### Introduction

This design element is a 16-bit decoder that is used to build wide-decoder functions. It is implemented by cascading CY\_MUX elements driven by Look-Up Tables (LUTs). The C\_IN pin can only be driven by the output (O) of a previous decode stage. When one or more of the inputs (A) are Low, the output is Low. When all the inputs are High and the C\_IN input is High, the output is High. You can decode patterns by adding inverters to inputs.

### Logic Table

Inputs					Outputs
A0	A1	...	Az	C_IN	O
1	1	1	1	1	1
X	X	X	X	0	0
0	X	X	X	X	0
X	0	X	X	X	0
X	X	X	0	X	0

*z = 3 for DEC\_CC4; z = 7 for DEC\_CC8; z = 15 for DEC\_CC16*

### Design Entry Method

This design element is only for use in schematics.

## For More Information

- See the [Spartan-3 User Guide](#).
- See the [Spartan-3 Data Sheets](#).



## DEC\_CC4

Macro: 4-Bit Active Low Decoder

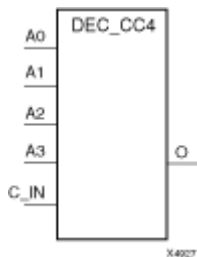

### Introduction

This design element is a 4-bit decoder that is used to build wide-decoder functions. It is implemented by cascading CY\_MUX elements driven by Look-Up Tables (LUTs). The C\_IN pin can only be driven by the output (O) of a previous decode stage. When one or more of the inputs (A) are Low, the output is Low. When all the inputs are High and the C\_IN input is High, the output is High. You can decode patterns by adding inverters to inputs.

### Logic Table

Inputs					Outputs
A0	A1	...	Az	C_IN	O
1	1	1	1	1	1
X	X	X	X	0	0
0	X	X	X	X	0
X	0	X	X	X	0
X	X	X	0	X	0

*z = 3 for DEC\_CC4; z = 7 for DEC\_CC8; z = 15 for DEC\_CC16*

### Design Entry Method

This design element is only for use in schematics.

### For More Information

- See the [Spartan-3 User Guide](#).
- See the [Spartan-3 Data Sheets](#).

## DEC\_CC8

Macro: 8-Bit Active Low Decoder

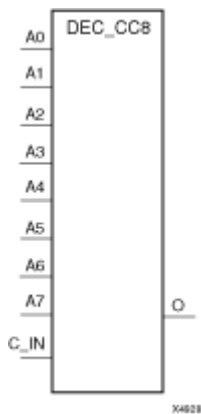

### Introduction

This design element is a 8-bit decoder that is used to build wide-decoder functions. It is implemented by cascading CY\_MUX elements driven by Look-Up Tables (LUTs). The C\_IN pin can only be driven by the output (O) of a previous decode stage. When one or more of the inputs (A) are Low, the output is Low. When all the inputs are High and the C\_IN input is High, the output is High. You can decode patterns by adding inverters to inputs.

### Logic Table

Inputs					Outputs
A0	A1	...	Az	C_IN	O
1	1	1	1	1	1
X	X	X	X	0	0
0	X	X	X	X	0
X	0	X	X	X	0
X	X	X	0	X	0

*z = 3 for DEC\_CC4; z = 7 for DEC\_CC8; z = 15 for DEC\_CC16*

### Design Entry Method

This design element is only for use in schematics.

### For More Information

- See the [Spartan-3 User Guide](#).
- See the [Spartan-3 Data Sheets](#).

# DECODE16

Macro: 16-Bit Active-Low Decoder

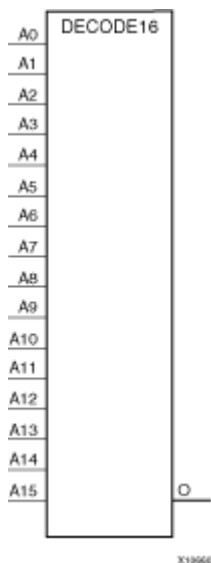

## Introduction

In Spartan-3E, decoders are implemented using combinations of LUTs and MUXCYs.

## Logic Table

Inputs				Outputs*
A0	A1	...	Az	O
1	1	1	1	1
0	X	X	X	0
X	0	X	X	0
X	X	X	0	0

z = bitwidth -1  
 \*A pull-up resistor must be connected to the output to establish High-level drive current.

## Design Entry Method

This design element is only for use in schematics.

## For More Information

- See the [Spartan-3 User Guide](#).
- See the [Spartan-3 Data Sheets](#).

## DECODE32

Macro: 32-Bit Active-Low Decoder

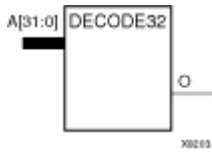

### Introduction

This design element is a 32-bit active-low decoder that is implemented using combinations of LUTs and MUXCYs.

### Logic Table

Inputs				Outputs
A0	A1	...	Az	O
1	1	1	1	1
0	X	X	X	0
X	0	X	X	0
X	X	X	0	0

*z = 31 for DECODE32, z = 63 for DECODE64*

### Design Entry Method

This design element is only for use in schematics.

### For More Information

- See the [Spartan-3 User Guide](#).
- See the [Spartan-3 Data Sheets](#).

# DECODE4

Macro: 4-Bit Active-Low Decoder

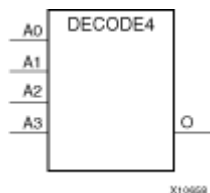

## Introduction

In Spartan-3E, decoders are implemented using combinations of LUTs and MUXCYs.

## Logic Table

Inputs				Outputs*
A0	A1	...	Az	O
1	1	1	1	1
0	X	X	X	0
X	0	X	X	0
X	X	X	0	0

z = bitwidth -1

\*A pull-up resistor must be connected to the output to establish High-level drive current.

## Design Entry Method

This design element is only for use in schematics.

## For More Information

- See the [Spartan-3 User Guide](#).
- See the [Spartan-3 Data Sheets](#).

## DECODE64

Macro: 64-Bit Active-Low Decoder

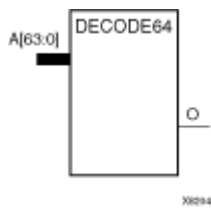

### Introduction

This design element is a 64-bit active-low decoder that is implemented using combinations of LUTs and MUXCYs.

### Logic Table

Inputs				Outputs
A0	A1	...	Az	O
1	1	1	1	1
0	X	X	X	0
X	0	X	X	0
X	X	X	0	0

*z = 31 for DECODE32, z = 63 for DECODE64*

### Design Entry Method

This design element is only for use in schematics.

### For More Information

- See the [Spartan-3 User Guide](#).
- See the [Spartan-3 Data Sheets](#).

# DECODE8

Macro: 8-Bit Active-Low Decoder

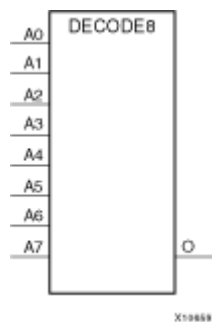

## Introduction

In Spartan-3E, decoders are implemented using combinations of LUTs and MUXCYs.

## Logic Table

Inputs				Outputs*
A0	A1	...	Az	O
1	1	1	1	1
0	X	X	X	0
X	0	X	X	0
X	X	X	0	0

z = bitwidth -1

\*A pull-up resistor must be connected to the output to establish High-level drive current.

## Design Entry Method

This design element is only for use in schematics.

## For More Information

- See the [Spartan-3 User Guide](#).
- See the [Spartan-3 Data Sheets](#).

## FD

Primitive: D Flip-Flop

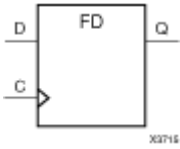

### Introduction

This design element is a D-type flip-flop with data input (D) and data output (Q). The data on the D inputs is loaded into the flip-flop during the Low-to-High clock (C) transition.

This flip-flop is asynchronously cleared, outputs Low, when power is applied. For FPGA devices, power-on conditions are simulated when global set/reset (GSR) is active. GSR defaults to active-High but can be inverted by adding an inverter in front of the GSR input of the appropriate *STARTUP\_architecture* symbol.

### Logic Table

Inputs		Outputs
D	C	Q
0	↑	0
1	↑	1

### Design Entry Method

This design element is only for use in schematics.

### Available Attributes

Attribute	Type	Allowed Values	Default	Description
INIT	Binary	0, 1	0	Sets the initial value of Q output after configuration

### For More Information

- See the [Spartan-3 User Guide](#).
- See the [Spartan-3 Data Sheets](#).



## FD\_1

Primitive: D Flip-Flop with Negative-Edge Clock

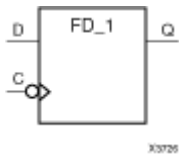

### Introduction

This design element is a single D-type flip-flop with data input (D) and data output (Q).

The data on the (D) input is loaded into the flip-flop during the High-to-Low clock (C) transition.

This flip-flop is asynchronously cleared, outputs Low, when power is applied. For FPGA devices, power-on conditions are simulated when global set/reset (GSR) is active. GSR defaults to active-High but can be inverted by adding an inverter in front of the GSR input of the appropriate *STARTUP\_architecture* symbol.

### Logic Table

Inputs		Outputs
D	C	Q
0	X	0
1	↓	1

### Design Entry Method

This design element is only for use in schematics.

### Available Attributes

Attribute	Type	Allowed Values	Default	Description
INIT	Binary	1-Bit Binary	1-Bit	Sets the initial value of Q output after configuration

### For More Information

- See the [Spartan-3 User Guide](#).
- See the [Spartan-3 Data Sheets](#).

## FD16CE

Macro: 16-Bit Data Register with Clock Enable and Asynchronous Clear

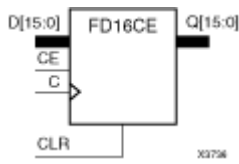

### Introduction

This design element is a 16-bit data register with clock enable and asynchronous clear. When clock enable (CE) is High and asynchronous clear (CLR) is Low, the data on the data inputs (D) is transferred to the corresponding data outputs (Q) during the Low-to-High clock (C) transition. When CLR is High, it overrides all other inputs and resets the data outputs (Q) Low. When CE is Low, clock transitions are ignored.

This register is asynchronously cleared, outputs Low, when power is applied. For FPGA devices, power-on conditions are simulated when global set/reset (GSR) is active. GSR defaults to active-High but can be inverted by adding an inverter in front of the GSR input of the appropriate `STARTUP_architecture` symbol.

### Logic Table

Inputs				Outputs
CLR	CE	D <sub>z</sub> – D <sub>0</sub>	C	Q <sub>z</sub> – Q <sub>0</sub>
1	X	X	X	0
0	0	X	X	No Change
0	1	D <sub>n</sub>	↑	D <sub>n</sub>

z = bit-width - 1

### Design Entry Method

This design element is only for use in schematics.

### Available Attributes

Attribute	Type	Allowed Values	Default	Description
INIT	Binary	16-bit Binary	All zeros	Sets the initial value of Q output after configuration

### For More Information

- See the [Spartan-3 User Guide](#).
- See the [Spartan-3 Data Sheets](#).

## FD16RE

Macro: 16-Bit Data Register with Clock Enable and Synchronous Reset

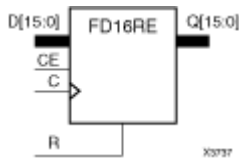

### Introduction

This design element is a 16-bit data registers. When the clock enable (CE) input is High, and the synchronous reset (R) input is Low, the data on the data inputs (D) is transferred to the corresponding data outputs (Q0) during the Low-to-High clock (C) transition. When R is High, it overrides all other inputs and resets the data outputs (Q) Low on the Low-to-High clock transition. When CE is Low, clock transitions are ignored.

This register is asynchronously cleared, outputs Low, when power is applied. For FPGA devices, power-on conditions are simulated when global set/reset (GSR) is active. GSR defaults to active-High but can be inverted by adding an inverter in front of the GSR input of the appropriate `STARTUP_architecture` symbol.

### Logic Table

Inputs				Outputs
R	CE	Dz – D0	C	Qz – Q0
1	X	X	↑	0
0	0	X	X	No Change
0	1	Dn	↑	Dn

z = bit-width - 1

### Design Entry Method

This design element is only for use in schematics.

### Available Attributes

Attribute	Type	Allowed Values	Default	Description
INIT	Binary	16-bit Binary	All zeros	Sets the initial value of Q output after configuration

### For More Information

- See the [Spartan-3 User Guide](#).
- See the [Spartan-3 Data Sheets](#).

## FD4CE

Macro: 4-Bit Data Register with Clock Enable and Asynchronous Clear

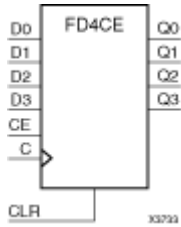

### Introduction

This design element is a 4-bit data register with clock enable and asynchronous clear. When clock enable (CE) is High and asynchronous clear (CLR) is Low, the data on the data inputs (D) is transferred to the corresponding data outputs (Q) during the Low-to-High clock (C) transition. When CLR is High, it overrides all other inputs and resets the data outputs (Q) Low. When CE is Low, clock transitions are ignored.

This register is asynchronously cleared, outputs Low, when power is applied. For FPGA devices, power-on conditions are simulated when global set/reset (GSR) is active. GSR defaults to active-High but can be inverted by adding an inverter in front of the GSR input of the appropriate `STARTUP_architecture` symbol.

### Logic Table

Inputs				Outputs
CLR	CE	D <sub>z</sub> – D0	C	Q <sub>z</sub> – Q0
1	X	X	X	0
0	0	X	X	No Change
0	1	D <sub>n</sub>	↑	D <sub>n</sub>

z = bit-width - 1

### Design Entry Method

This design element is only for use in schematics.

### Available Attributes

Attribute	Type	Allowed Values	Default	Description
INIT	Binary	4-bit Binary	All zeros	Sets the initial value of Q output after configuration

### For More Information

- See the [Spartan-3 User Guide](#).
- See the [Spartan-3 Data Sheets](#).

## FD4RE

Macro: 4-Bit Data Register with Clock Enable and Synchronous Reset

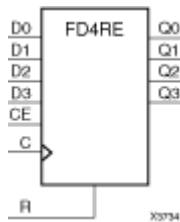

### Introduction

This design element is a 4-bit data registers. When the clock enable (CE) input is High, and the synchronous reset (R) input is Low, the data on the data inputs (D) is transferred to the corresponding data outputs (Q0) during the Low-to-High clock (C) transition. When R is High, it overrides all other inputs and resets the data outputs (Q) Low on the Low-to-High clock transition. When CE is Low, clock transitions are ignored.

This register is asynchronously cleared, outputs Low, when power is applied. For FPGA devices, power-on conditions are simulated when global set/reset (GSR) is active. GSR defaults to active-High but can be inverted by adding an inverter in front of the GSR input of the appropriate *STARTUP\_architecture* symbol.

### Logic Table

Inputs				Outputs
R	CE	Dz – D0	C	Qz – Q0
1	X	X	↑	0
0	0	X	X	No Change
0	1	Dn	↑	Dn

z = bit-width - 1

### Design Entry Method

This design element is only for use in schematics.

### Available Attributes

Attribute	Type	Allowed Values	Default	Description
INIT	Binary	4-bit Binary	All zeros	Sets the initial value of Q output after configuration

### For More Information

- See the [Spartan-3 User Guide](#).
- See the [Spartan-3 Data Sheets](#).

## FD8CE

Macro: 8-Bit Data Register with Clock Enable and Asynchronous Clear

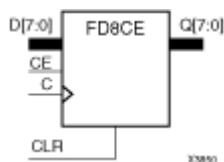

### Introduction

This design element is a 8-bit data register with clock enable and asynchronous clear. When clock enable (CE) is High and asynchronous clear (CLR) is Low, the data on the data inputs (D) is transferred to the corresponding data outputs (Q) during the Low-to-High clock (C) transition. When CLR is High, it overrides all other inputs and resets the data outputs (Q) Low. When CE is Low, clock transitions are ignored.

This register is asynchronously cleared, outputs Low, when power is applied. For FPGA devices, power-on conditions are simulated when global set/reset (GSR) is active. GSR defaults to active-High but can be inverted by adding an inverter in front of the GSR input of the appropriate `STARTUP_architecture` symbol.

### Logic Table

Inputs				Outputs
CLR	CE	Dz - D0	C	Qz - Q0
1	X	X	X	0
0	0	X	X	No Change
0	1	Dn	↑	Dn

z = bit-width - 1

### Design Entry Method

This design element is only for use in schematics.

### Available Attributes

Attribute	Type	Allowed Values	Default	Description
INIT	Binary	8-bit Binary	All zeros	Sets the initial value of Q output after configuration

### For More Information

- See the [Spartan-3 User Guide](#).
- See the [Spartan-3 Data Sheets](#).

## FD8RE

Macro: 8-Bit Data Register with Clock Enable and Synchronous Reset

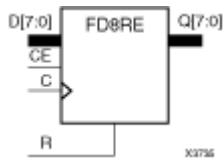

### Introduction

This design element is an 8-bit data register. When the clock enable (CE) input is High, and the synchronous reset (R) input is Low, the data on the data inputs (D) is transferred to the corresponding data outputs (Q) during the Low-to-High clock (C) transition. When R is High, it overrides all other inputs and resets the data outputs (Q) Low on the Low-to-High clock transition. When CE is Low, clock transitions are ignored.

This register is asynchronously cleared, outputs Low, when power is applied. For FPGA devices, power-on conditions are simulated when global set/reset (GSR) is active. GSR defaults to active-High but can be inverted by adding an inverter in front of the GSR input of the appropriate `STARTUP_architecture` symbol.

### Logic Table

Inputs				Outputs
R	CE	Dz – D0	C	Qz – Q0
1	X	X	↑	0
0	0	X	X	No Change
0	1	Dn	↑	Dn

z = bit-width - 1

### Design Entry Method

This design element is only for use in schematics.

### Available Attributes

Attribute	Type	Allowed Values	Default	Description
INIT	Binary	Any 8-Bit Value	All zeros	Sets the initial value of Q output after configuration.

### For More Information

- See the [Spartan-3 User Guide](#).
- See the [Spartan-3 Data Sheets](#).

## FDC

Primitive: D Flip-Flop with Asynchronous Clear

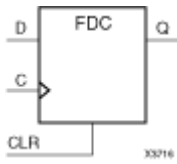

### Introduction

This design element is a single D-type flip-flop with data (D) and asynchronous clear (CLR) inputs and data output (Q). The asynchronous CLR, when High, overrides all other inputs and sets the (Q) output Low. The data on the (D) input is loaded into the flip-flop when CLR is Low on the Low-to-High clock transition.

This flip-flop is asynchronously cleared, outputs Low, when power is applied. For FPGA devices, power-on conditions are simulated when global set/reset (GSR) is active. GSR defaults to active-High but can be inverted by adding an inverter in front of the GSR input of the appropriate `STARTUP_architecture` symbol.

### Logic Table

Inputs			Outputs
CLR	D	C	Q
1	X	X	0
0	D	↑	D

### Design Entry Method

This design element is only for use in schematics.

### Available Attributes

Attribute	Type	Allowed Values	Default	Description
INIT	Binary	0, 1	0	Sets the initial value of Q output after configuration

### For More Information

- See the [Spartan-3 User Guide](#).
- See the [Spartan-3 Data Sheets](#).



## FDC\_1

Primitive: D Flip-Flop with Negative-Edge Clock and Asynchronous Clear

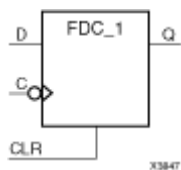

### Introduction

FDC\_1 is a single D-type flip-flop with data input (D), asynchronous clear input (CLR), and data output (Q). The asynchronous CLR, when active, overrides all other inputs and sets the (Q) output Low. The data on the (D) input is loaded into the flip-flop during the High-to-Low clock (C) transition.

This flip-flop is asynchronously cleared, outputs Low, when power is applied. For FPGA devices, power-on conditions are simulated when global set/reset (GSR) is active. GSR defaults to active-High but can be inverted by adding an inverter in front of the GSR input of the appropriate *STARTUP\_architecture* symbol.

### Logic Table

Inputs			Outputs
CLR	D	C	Q
1	X	X	0
0	D	↓	D

### Design Entry Method

This design element is only for use in schematics.

### Available Attributes

Attribute	Type	Allowed Values	Default	Description
INIT	1-Bit Binary	0, 1	0	Sets the initial value of Q output after configuration

### For More Information

- See the [Spartan-3 User Guide](#).
- See the [Spartan-3 Data Sheets](#).

## FDCE

Primitive: D Flip-Flop with Clock Enable and Asynchronous Clear

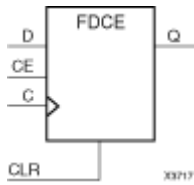

### Introduction

This design element is a single D-type flip-flop with clock enable and asynchronous clear. When clock enable (CE) is High and asynchronous clear (CLR) is Low, the data on the data input (D) of this design element is transferred to the corresponding data output (Q) during the Low-to-High clock (C) transition. When CLR is High, it overrides all other inputs and resets the data output (Q) Low. When CE is Low, clock transitions are ignored.

For XC9500XL and XC9500XV devices, logic connected to the clock enable (CE) input may be implemented using the clock enable product term (p-term) in the macrocell, provided the logic can be completely implemented using the single p-term available for clock enable without requiring feedback from another macrocell. Only FDCE and FDPE flip-flops may take advantage of the clock-enable p-term.

This flip-flop is asynchronously cleared, outputs Low, when power is applied. For FPGA devices, power-on conditions are simulated when global set/reset (GSR) is active. GSR defaults to active-High but can be inverted by adding an inverter in front of the GSR input of the appropriate `STARTUP_architecture` symbol.

### Logic Table

Inputs				Outputs
CLR	CE	D	C	Q
1	X	X	X	0
0	0	X	X	No Change
0	1	D	↑	D

### Design Entry Method

This design element can be used in schematics.

### Available Attributes

Attribute	Type	Allowed Values	Default	Description
INIT	1-Bit Binary	0 or 1	0	Sets the initial value of Q output after configuration.

### For More Information

- See the [Spartan-3 User Guide](#).
- See the [Spartan-3 Data Sheets](#).

## FDCE\_1

Primitive: D Flip-Flop with Negative-Edge Clock, Clock Enable, and Asynchronous Clear

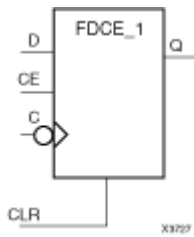

### Introduction

This design element is a single D-type flip-flop with data (D), clock enable (CE), asynchronous clear (CLR) inputs, and data output (Q). The asynchronous CLR input, when High, overrides all other inputs and sets the Q output Low. The data on the (D) input is loaded into the flip-flop when CLR is Low and CE is High on the High-to-Low clock (C) transition. When CE is Low, the clock transitions are ignored.

This flip-flop is asynchronously cleared, outputs Low, when power is applied. For FPGA devices, power-on conditions are simulated when global set/reset (GSR) is active. GSR defaults to active-High but can be inverted by adding an inverter in front of the GSR input of the appropriate *STARTUP\_architecture* symbol.

### Logic Table

Inputs				Outputs
CLR	CE	D	C	Q
1	X	X	X	0
0	0	X	?	No Change
0	1	1	?	1
0	1	0	?	0

### Design Entry Method

This design element can be used in schematics.

### Available Attributes

Attribute	Type	Allowed Values	Default	Description
INIT	1-Bit Binary	0 or 1	0	Sets the initial value of Q output after configuration.

### For More Information

- See the [Spartan-3 User Guide](#).
- See the [Spartan-3 Data Sheets](#).

## FDCP

Primitive: D Flip-Flop with Asynchronous Preset and Clear

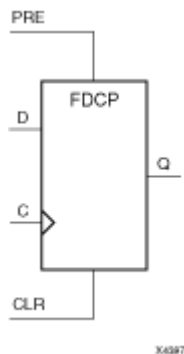

### Introduction

This design element is a single D-type flip-flop with data (D), asynchronous preset (PRE) and clear (CLR) inputs, and data output (Q). The asynchronous PRE, when High, sets the (Q) output High; CLR, when High, resets the output Low. Data on the (D) input is loaded into the flip-flop when PRE and CLR are Low on the Low-to-High clock (C) transition.

This flip-flop is asynchronously cleared, outputs Low, when power is applied. For FPGA devices, power-on conditions are simulated when global set/reset (GSR) is active. GSR defaults to active-High but can be inverted by adding an inverter in front of the GSR input of the appropriate `STARTUP_architecture` symbol.

### Logic Table

Inputs				Outputs
CLR	PRE	D	C	Q
1	X	X	X	0
0	1	X	X	1
0	0	D	↑	D

### Design Entry Method

This design element is only for use in schematics.

### Available Attributes

Attribute	Type	Allowed Values	Default	Description
INIT	1-Bit Binary	0 or 1	0	Sets the initial value of Q output after configuration

### For More Information

- See the [Spartan-3 User Guide](#).
- See the [Spartan-3 Data Sheets](#).

## FDCEP\_1

Primitive: D Flip-Flop with Negative-Edge Clock and Asynchronous Preset and Clear

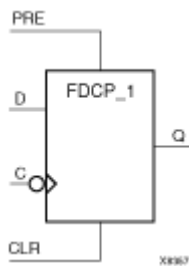

### Introduction

This design element is a single D-type flip-flop with data (D), asynchronous preset (PRE) and clear (CLR) inputs, and data output (Q). The asynchronous PRE, when High, sets the (Q) output High; CLR, when High, resets the output Low. Data on the (D) input is loaded into the flip-flop when PRE and CLR are Low on the High-to-Low clock (C) transition.

This flip-flop is asynchronously cleared, outputs Low, when power is applied. For FPGA devices, power-on conditions are simulated when global set/reset (GSR) is active. GSR defaults to active-High but can be inverted by adding an inverter in front of the GSR input of the appropriate *STARTUP\_architecture* symbol.

### Logic Table

Inputs				Outputs
CLR	PRE	D	C	Q
1	X	X	X	0
0	1	X	X	1
0	0	0	↓	0
0	0	1	↓	1

### Design Entry Method

This design element is only for use in schematics.

### Available Attributes

Attribute	Type	Allowed Values	Default	Description
INIT	1-Bit Binary	0 or 1	0	Sets the initial value of Q output after configuration.

### For More Information

- See the [Spartan-3 User Guide](#).
- See the [Spartan-3 Data Sheets](#).

## FDCPE

Primitive: D Flip-Flop with Clock Enable and Asynchronous Preset and Clear

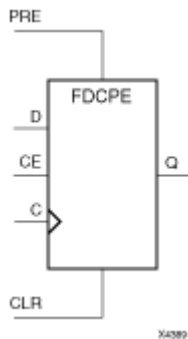

### Introduction

This design element is a single D-type flip-flop with data (D), clock enable (CE), asynchronous preset (PRE), and asynchronous clear (CLR) inputs. The asynchronous active high PRE sets the Q output High; that active high CLR resets the output Low and has precedence over the PRE input. Data on the D input is loaded into the flip-flop when PRE and CLR are Low and CE is High on the Low-to-High clock (C) transition. When CE is Low, the clock transitions are ignored and the previous value is retained. The FDCPE is generally implemented as a slice or IOB register within the device.

For FPGA devices, upon power-up, the initial value of this component is specified by the INIT attribute. If a subsequent GSR (Global Set/Reset) is asserted, the flop is asynchronously set to the INIT value.

**Note** While this device supports the use of asynchronous set and reset, it is not generally recommended to be used for in most cases. Use of asynchronous signals pose timing issues within the design that are difficult to detect and control and also have an adverse affect on logic optimization causing a larger design that can consume more power than if a synchronous set or reset is used.

### Logic Table

Inputs					Outputs
CLR	PRE	CE	D	C	Q
1	X	X	X	X	0
0	1	X	X	X	1
0	0	0	X	X	No Change
0	0	1	D	↑	D

### Port Descriptions

Name	Direction	Width	Function
Q	Output	1-Bit	Data output
C	Input	1-Bit	Clock input
CE	Input	1-Bit	Clock enable input
CLR	Input	1-Bit	Asynchronous clear input
D	Input	1-Bit	Data input
PRE	Input	1-Bit	Asynchronous set input

## Design Entry Method

This design element can be used in schematics.

## Available Attributes

Attribute	Type	Allowed Values	Default	Description
INIT	1-Bit Binary	0 or 1	0	Sets the initial value of Q output after configuration and on GSR

## For More Information

- See the [Spartan-3 User Guide](#).
- See the [Spartan-3 Data Sheets](#).

## FDCPE\_1

Primitive: D Flip-Flop with Negative-Edge Clock, Clock Enable, and Asynchronous Preset and Clear

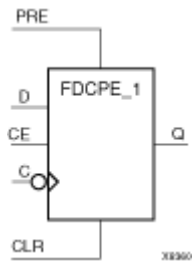

### Introduction

FDCPE\_1 is a single D-type flip-flop with data (D), clock enable (CE), asynchronous preset (PRE), and asynchronous clear (CLR) inputs and data output (Q). The asynchronous PRE, when High, sets the (Q) output High; CLR, when High, resets the output Low. Data on the (D) input is loaded into the flip-flop when PRE and CLR are Low and CE is High on the High-to-Low clock (C) transition. When CE is Low, the clock transitions are ignored.

This flip-flop is asynchronously cleared, outputs Low, when power is applied. For FPGA devices, power-on conditions are simulated when global set/reset (GSR) is active. GSR defaults to active-High but can be inverted by adding an inverter in front of the GSR input of the appropriate STARTUP\_architecture symbol.

### Logic Table

Inputs					Outputs
CLR	PRE	CE	D	C	Q
1	X	X	X	X	0
0	1	X	X	X	1
0	0	0	X	X	No Change
0	0	1	D	↓	D

### Port Descriptions

Name	Direction	Width	Function
Q	Output	1-Bit	Data output
C	Input	1-Bit	Clock input
CE	Input	1-Bit	Clock enable input
CLR	Input	1-Bit	Asynchronous clear input
D	Input	1-Bit	Data input
PRE	Input	1-Bit	Asynchronous set input

### Design Entry Method

This design element can be used in schematics.



## Available Attributes

Attribute	Type	Allowed Values	Default	Description
INIT	1-Bit Binary	0 or 1	0	Sets the initial value of Q output after configuration

## For More Information

- See the [Spartan-3 User Guide](#).
- See the [Spartan-3 Data Sheets](#).

## FDDRCPE

Primitive: Dual Data Rate D Flip-Flop with Clock Enable and Asynchronous Preset and Clear

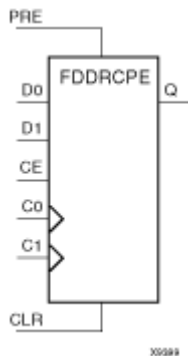

### Introduction

FDDRCPE is a Dual Data Rate (DDR) D flip-flop with two separate clocks (C0 and C1) phase shifted 180 degrees that allow selection of two separate data inputs (D0 and D1). It also has clock enable (CE), asynchronous preset (PRE), and asynchronous clear (CLR) inputs and data output (Q). The asynchronous PRE, when High, sets the Q output High; CLR, when High, resets the output Low. Data on the D0 input is loaded into the flip-flop when PRE and CLR are Low and CE is High on the Low-to-High C0 clock transition. Data on the D1 input is loaded into the flip-flop when PRE and CLR are Low and CE is High on the Low-to-High C1 clock transition. When CE is Low, the clock transitions are ignored.

Use the INIT attribute to initialize FDDRCPE during configuration.

This flip-flop is asynchronously cleared, outputs Low, when power is applied. For FPGA devices, power-on conditions are simulated when global set/reset (GSR) is active. GSR defaults to active-High but can be inverted by adding an inverter in front of the GSR input of the appropriate STARTUP\_architecture symbol.

### Logic Table

Inputs							Outputs
C0	C1	CE	D0	D1	CLR	PRE	Q
X	X	X	X	X	1	0	0
X	X	X	X	X	0	1	1
X	X	X	X	X	1	1	0
X	X	0	X	X	0	0	No Change
↑	X	1	D0	X	0	0	D0
X	↑	1	X	D1	0	0	D1

### Design Entry Method

This design element is only for use in schematics.

### For More Information

- See the [Spartan-3 User Guide](#).
- See the [Spartan-3 Data Sheets](#).

## FDDRSE

Primitive: Dual Data Rate D Flip-Flop with Clock Enable and Synchronous Reset and Set

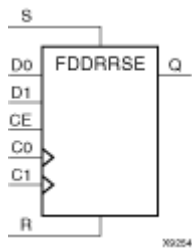

### Introduction

FDDRSE is a Dual Data Rate (DDR) D flip-flop with two separate clocks (C0 and C1) phase shifted 180 degrees that allow selection of two separate data inputs (D0 and D1). It also has synchronous reset (R), synchronous set (S), and clock enable (CE) inputs and data output (Q). The reset (R) input, when High, overrides all other inputs and resets the Q output Low during any Low-to-High clock transition (C0 or C1). (Reset has precedence over Set.) When the S input is High and R is Low, the flip-flop is set, output High, during a Low-to-High clock transition (C0 or C1). Data on the D0 input is loaded into the flip-flop when R and S are Low and CE is High during the Low-to-High C0 clock transition. Data on the D1 input is loaded into the flip-flop when R and S are Low and CE is High during the Low-to-High C1 clock transition.

Use the INIT attribute to initialize FDDRSE during configuration.

This flip-flop is asynchronously cleared, outputs Low, when power is applied. For FPGA devices, power-on conditions are simulated when global set/reset (GSR) is active. GSR defaults to active-High but can be inverted by adding an inverter in front of the GSR input of the appropriate STARTUP\_architecture symbol.

### Logic Table

Inputs							Outputs
C0	C1	CE	D0	D1	R	S	Q
↑	X	X	X	X	1	0	0
↑	X	X	X	X	0	1	1
↑	X	X	X	X	1	1	0
X	↑	X	X	X	1	0	0
X	↑	X	X	X	0	1	1
X	↑	X	X	X	1	1	0
X	X	0	X	X	0	0	No Change
↑	X	1	D0	X	0	0	D0
X	↑	1	X	D1	0	0	D1

### Design Entry Method

This design element is only for use in schematics.

### For More Information

- See the [Spartan-3 User Guide](#).
- See the [Spartan-3 Data Sheets](#).

## FDE

Primitive: D Flip-Flop with Clock Enable

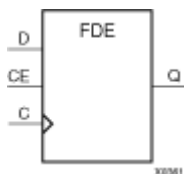

### Introduction

This design element is a single D-type flip-flop with data input (D), clock enable (CE), and data output (Q). When clock enable is High, the data on the (D) input is loaded into the flip-flop during the Low-to-High clock (C) transition.

This flip-flop is asynchronously cleared, outputs Low, when power is applied. For FPGA devices, power-on conditions are simulated when global set/reset (GSR) is active. GSR defaults to active-High but can be inverted by adding an inverter in front of the GSR input of the appropriate `STARTUP_architecture` symbol.

### Logic Table

Inputs			Outputs
CE	D	C	Q
0	X	X	No Change
1	0	↑	0
1	1	↑	1

### Design Entry Method

This design element is only for use in schematics.

### Available Attributes

Attribute	Type	Allowed Values	Default	Description
INIT	1-Bit Binary	0 or 1	0	Sets the initial value of Q output after configuration

### For More Information

- See the [Spartan-3 User Guide](#).
- See the [Spartan-3 Data Sheets](#).

## FDE\_1

Primitive: D Flip-Flop with Negative-Edge Clock and Clock Enable

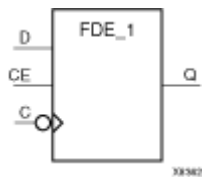

### Introduction

This design element is a single D-type flip-flop with data input (D), clock enable (CE), and data output (Q). When clock enable is High, the data on the (D) input is loaded into the flip-flop during the High-to-Low clock (C) transition.

This flip-flop is asynchronously cleared, outputs Low, when power is applied. For FPGA devices, power-on conditions are simulated when global set/reset (GSR) is active. GSR defaults to active-High but can be inverted by adding an inverter in front of the GSR input of the appropriate `STARTUP_architecture` symbol.

### Logic Table

Inputs			Outputs
CE	D	C	Q
0	X	X	No Change
1	0	↓	0
1	1	↓	1

### Design Entry Method

This design element is only for use in schematics.

### Available Attributes

Attribute	Type	Allowed Values	Default	Description
INIT	1-Bit Binary	0 or 1	0	Sets the initial value of Q output after configuration

### For More Information

- See the [Spartan-3 User Guide](#).
- See the [Spartan-3 Data Sheets](#).

## FDP

Primitive: D Flip-Flop with Asynchronous Preset

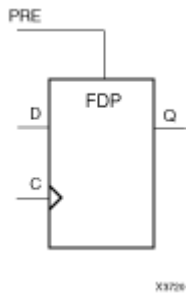

### Introduction

This design element is a single D-type flip-flop with data (D) and asynchronous preset (PRE) inputs and data output (Q). The asynchronous PRE, when High, overrides all other inputs and presets the (Q) output High. The data on the (D) input is loaded into the flip-flop when PRE is Low on the Low-to-High clock (C) transition.

For FPGA devices, this flip-flop is asynchronously preset, output High, when power is applied. Power-on conditions are simulated when global set/reset (GSR) is active. GSR defaults to active-High but can be inverted by adding an inverter in front of the GSR input of the appropriate `STARTUP_architecture` symbol.

### Logic Table

Inputs			Outputs
PRE	C	D	Q
1	X	X	1
0	↑	D	D
0	↑	0	0

### Design Entry Method

This design element is only for use in schematics.

### Available Attributes

Attribute	Type	Allowed Values	Default	Description
INIT	1-Bit Binary	0 or 1	0	Sets the initial value of Q output after configuration

### For More Information

- See the [Spartan-3 User Guide](#).
- See the [Spartan-3 Data Sheets](#).

## FDP\_1

Primitive: D Flip-Flop with Negative-Edge Clock and Asynchronous Preset

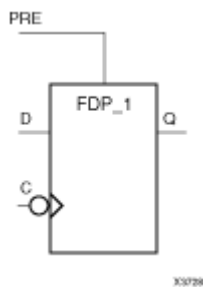

### Introduction

This design element is a single D-type flip-flop with data (D) and asynchronous preset (PRE) inputs and data output (Q). The asynchronous PRE, when High, overrides all other inputs and presets the Q output High. The data on the D input is loaded into the flip-flop when PRE is Low on the High-to-Low clock (C) transition.

This flip-flop is asynchronously preset, output High, when power is applied. For FPGA devices, power-on conditions are simulated when global set/reset (GSR) is active. GSR defaults to active-High but can be inverted by adding an inverter in front of the GSR input of the appropriate *STARTUP\_architecture* symbol.

### Logic Table

Inputs			Outputs
PRE	C	D	Q
1	X	X	1
0	↓	D	D

### Design Entry Method

This design element is only for use in schematics.

### Available Attributes

Attribute	Type	Allowed Values	Default	Description
INIT	1-Bit Binary	0 or 1	0	Sets the initial value of Q output after configuration

### For More Information

- See the [Spartan-3 User Guide](#).
- See the [Spartan-3 Data Sheets](#).

## FDPE

Primitive: D Flip-Flop with Clock Enable and Asynchronous Preset

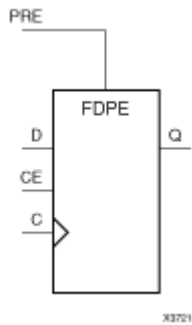

### Introduction

This design element is a single D-type flip-flop with data (D), clock enable (CE), and asynchronous preset (PRE) inputs and data output (Q). The asynchronous PRE, when High, overrides all other inputs and sets the (Q) output High. Data on the (D) input is loaded into the flip-flop when PRE is Low and CE is High on the Low-to-High clock (C) transition. When CE is Low, the clock transitions are ignored.

For FPGA devices, this flip-flop is asynchronously preset, output High, when power is applied. Power-on conditions are simulated when global set/reset (GSR) is active. GSR defaults to active-High but can be inverted by adding an inverter in front of the GSR input of the appropriate `STARTUP_architecture` symbol.

### Logic Table

Inputs				Outputs
PRE	CE	D	C	Q
1	X	X	X	1
0	0	X	X	No Change
0	1	D	↑	D

### Design Entry Method

This design element is only for use in schematics.

### Available Attributes

Attribute	Type	Allowed Values	Default	Description
INIT	1-Bit Binary	0 or 1	0	Sets the initial value of Q output after configuration

### For More Information

- See the [Spartan-3 User Guide](#).
- See the [Spartan-3 Data Sheets](#).



## FDPE\_1

Primitive: D Flip-Flop with Negative-Edge Clock, Clock Enable, and Asynchronous Preset

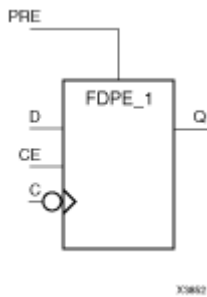

### Introduction

This design element is a single D-type flip-flop with data (D), clock enable (CE), and asynchronous preset (PRE) inputs and data output (Q). The asynchronous PRE, when High, overrides all other inputs and sets the (Q) output High. Data on the (D) input is loaded into the flip-flop when PRE is Low and CE is High on the High-to-Low clock (C) transition. When CE is Low, the clock transitions are ignored.

For FPGA devices, this flip-flop is asynchronously preset, output High, when power is applied. Power-on conditions are simulated when global set/reset (GSR) is active. GSR defaults to active-High but can be inverted by adding an inverter in front of the GSR input of the appropriate `STARTUP_architecture` symbol.

### Logic Table

Inputs				Outputs
PRE	CE	D	C	Q
1	X	X	X	1
0	0	X	X	No Change
0	1	D	↓	D

### Design Entry Method

This design element is only for use in schematics.

### Available Attributes

Attribute	Type	Allowed Values	Default	Description
INIT	1-Bit Binary	0 or 1	0	Sets the initial value of Q output after configuration

### For More Information

- See the [Spartan-3 User Guide](#).
- See the [Spartan-3 Data Sheets](#).

## FDR

Primitive: D Flip-Flop with Synchronous Reset

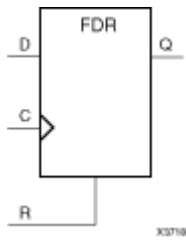

### Introduction

This design element is a single D-type flip-flop with data (D) and synchronous reset (R) inputs and data output (Q). The synchronous reset (R) input, when High, overrides all other inputs and resets the (Q) output Low on the Low-to-High clock (C) transition. The data on the (D) input is loaded into the flip-flop when R is Low during the Low-to-High clock transition.

This flip-flop is asynchronously cleared, outputs Low, when power is applied. For FPGA devices, power-on conditions are simulated when global set/reset (GSR) is active. GSR defaults to active-High but can be inverted by adding an inverter in front of the GSR input of the appropriate `STARTUP_architecture` symbol.

### Logic Table

Inputs			Outputs
R	D	C	Q
1	X	↑	0
0	D	↑	D

### Design Entry Method

This design element is only for use in schematics.

### Available Attributes

Attribute	Type	Allowed Values	Default	Description
INIT	1-Bit Binary	0 or 1	0	Sets the initial value of Q output after configuration

### For More Information

- See the [Spartan-3 User Guide](#).
- See the [Spartan-3 Data Sheets](#).

## FDR\_1

Primitive: D Flip-Flop with Negative-Edge Clock and Synchronous Reset

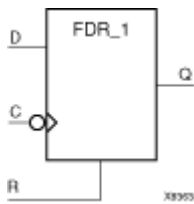

### Introduction

This design element is a single D-type flip-flop with data (D) and synchronous reset (R) inputs and data output (Q). The synchronous reset (R) input, when High, overrides all other inputs and resets the (Q) output Low on the High-to-Low clock (C) transition. The data on the (D) input is loaded into the flip-flop when R is Low during the High-to-Low clock transition.

This flip-flop is asynchronously cleared, outputs Low, when power is applied. For FPGA devices, power-on conditions are simulated when global set/reset (GSR) is active. GSR defaults to active-High but can be inverted by adding an inverter in front of the GSR input of the appropriate *STARTUP\_architecture* symbol.

### Logic Table

Inputs			Outputs
R	D	C	Q
1	X	↓	0
0	D	↓	D

### Design Entry Method

This design element is only for use in schematics.

### Available Attributes

Attribute	Type	Allowed Values	Default	Description
INIT	1-Bit Binary	0 or 1	0	Sets the initial value of Q output after configuration.

### For More Information

- See the [Spartan-3 User Guide](#).
- See the [Spartan-3 Data Sheets](#).

## FDRE

Primitive: D Flip-Flop with Clock Enable and Synchronous Reset

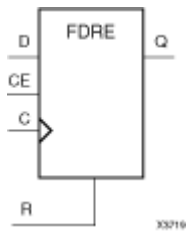

### Introduction

This design element is a single D-type flip-flop with data (D), clock enable (CE), and synchronous reset (R) inputs and data output (Q). The synchronous reset (R) input, when High, overrides all other inputs and resets the (Q) output Low on the Low-to-High clock (C) transition. The data on the (D) input is loaded into the flip-flop when R is Low and CE is High during the Low-to-High clock transition.

This flip-flop is asynchronously cleared, outputs Low, when power is applied. For FPGA devices, power-on conditions are simulated when global set/reset (GSR) is active. GSR defaults to active-High but can be inverted by adding an inverter in front of the GSR input of the appropriate `STARTUP_architecture` symbol.

### Logic Table

Inputs				Outputs
R	CE	D	C	Q
1	X	X	↑	0
0	0	X	X	No Change
0	1	D	↑	D

### Design Entry Method

This design element is only for use in schematics.

### Available Attributes

Attribute	Type	Allowed Values	Default	Description
INIT	1-Bit Binary	0 or 1	0	Sets the initial value of Q output after configuration.

### For More Information

- See the [Spartan-3 User Guide](#).
- See the [Spartan-3 Data Sheets](#).

## FDRE\_1

Primitive: D Flip-Flop with Negative-Clock Edge, Clock Enable, and Synchronous Reset

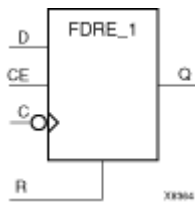

### Introduction

FDRE\_1 is a single D-type flip-flop with data (D), clock enable (CE), and synchronous reset (R) inputs and data output (Q). The synchronous reset (R) input, when High, overrides all other inputs and resets the (Q) output Low on the High-to-Low clock (C) transition. The data on the (D) input is loaded into the flip-flop when R is Low and CE is High during the High-to-Low clock transition.

This flip-flop is asynchronously cleared, outputs Low, when power is applied. For FPGA devices, power-on conditions are simulated when global set/reset (GSR) is active. GSR defaults to active-High but can be inverted by adding an inverter in front of the GSR input of the appropriate *STARTUP\_architecture* symbol.

### Logic Table

Inputs				Outputs
R	CE	D	C	Q
1	X	X	↓	0
0	0	X	X	No Change
0	1	D	↓	D

### Design Entry Method

This design element is only for use in schematics.

### Available Attributes

Attribute	Type	Allowed Values	Default	Description
INIT	1-Bit Binary	0 or 1	0	Sets the initial value of Q output after configuration.

### For More Information

- See the [Spartan-3 User Guide](#).
- See the [Spartan-3 Data Sheets](#).

## FDRS

Primitive: D Flip-Flop with Synchronous Reset and Set

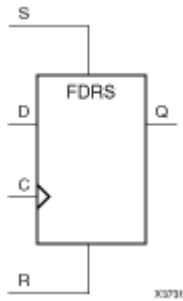

### Introduction

FDRS is a single D-type flip-flop with data (D), synchronous set (S), and synchronous reset (R) inputs and data output (Q). The synchronous reset (R) input, when High, overrides all other inputs and resets the (Q) output Low during the Low-to-High clock (C) transition. (Reset has precedence over Set.) When S is High and R is Low, the flip-flop is set, output High, during the Low-to-High clock transition. When R and S are Low, data on the (D) input is loaded into the flip-flop during the Low-to-High clock transition.

This flip-flop is asynchronously cleared, outputs Low, when power is applied. For FPGA devices, power-on conditions are simulated when global set/reset (GSR) is active. GSR defaults to active-High but can be inverted by adding an inverter in front of the GSR input of the appropriate `STARTUP_architecture` symbol.

### Logic Table

Inputs				Outputs
R	S	D	C	Q
1	X	X	↓	0
0	1	X	↓	1
0	0	D	↓	D

### Design Entry Method

This design element is only for use in schematics.

### Available Attributes

Attribute	Type	Allowed Values	Default	Description
INIT	1-Bit Binary	0 or 1	0	Sets the initial value of Q output after configuration.

### For More Information

- See the [Spartan-3 User Guide](#).
- See the [Spartan-3 Data Sheets](#).

## FDRS\_1

Primitive: D Flip-Flop with Negative-Clock Edge and Synchronous Reset and Set

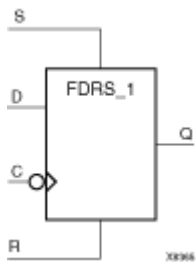

### Introduction

FDRS\_1 is a single D-type flip-flop with data (D), synchronous set (S), and synchronous reset (R) inputs and data output (Q). The synchronous reset (R) input, when High, overrides all other inputs and resets the (Q) output Low during the High-to-Low clock (C) transition. (Reset has precedence over Set.) When S is High and R is Low, the flip-flop is set, output High, during the High-to-Low clock transition. When R and S are Low, data on the (D) input is loaded into the flip-flop during the High-to-Low clock transition.

This flip-flop is asynchronously cleared, outputs Low, when power is applied. For FPGA devices, power-on conditions are simulated when global set/reset (GSR) is active. GSR defaults to active-High but can be inverted by adding an inverter in front of the GSR input of the appropriate *STARTUP\_architecture* symbol.

### Logic Table

Inputs				Outputs
R	S	D	C	Q
1	X	X	↓	0
0	1	X	↓	1
0	0	D	↓	D

### Design Entry Method

This design element is only for use in schematics.

### Available Attributes

Attribute	Type	Allowed Values	Default	Description
INIT	1-Bit Binary	0 or 1	0	Sets the initial value of Q output after configuration.

### For More Information

- See the [Spartan-3 User Guide](#).
- See the [Spartan-3 Data Sheets](#).

## FDRSE

Primitive: D Flip-Flop with Synchronous Reset and Set and Clock Enable

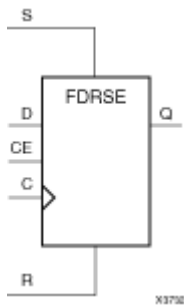

### Introduction

FDRSE is a single D-type flip-flop with synchronous reset (R), synchronous set (S), clock enable (CE) inputs. The reset (R) input, when High, overrides all other inputs and resets the Q output Low during the Low-to-High clock transition. (Reset has precedence over Set.) When the set (S) input is High and R is Low, the flip-flop is set, output High, during the Low-to-High clock (C) transition. Data on the D input is loaded into the flip-flop when R and S are Low and CE is High during the Low-to-High clock transition.

Upon power-up, the initial value of this component is specified by the INIT attribute. If a subsequent GSR (Global Set/Reset) is asserted, the flop is asynchronously set to the INIT value.

### Logic Table

Inputs					Outputs
R	S	CE	D	C	Q
1	X	X	X	↑	0
0	1	X	X	↑	1
0	0	0	X	X	No Change
0	0	1	1	↑	1
0	0	1	0	↑	0

### Design Entry Method

This design element can be used in schematics.

### Available Attributes

Attribute	Type	Allowed Values	Default	Description
INIT	1-Bit Binary	0 or 1	0	Sets the initial value of Q output after configuration and on GSR.

### For More Information

- See the [Spartan-3 User Guide](#).
- See the [Spartan-3 Data Sheets](#).



## FDRSE\_1

Primitive: D Flip-Flop with Negative-Clock Edge, Synchronous Reset and Set, and Clock Enable

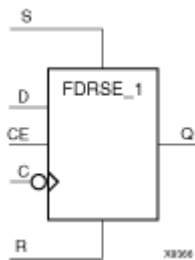

### Introduction

FDRSE\_1 is a single D-type flip-flop with synchronous reset (R), synchronous set (S), and clock enable (CE) inputs and data output (Q). The reset (R) input, when High, overrides all other inputs and resets the (Q) output Low during the High-to-Low clock transition. (Reset has precedence over Set.) When the set (S) input is High and R is Low, the flip-flop is set, output High, during the High-to-Low clock (C) transition. Data on the (D) input is loaded into the flip-flop when (R) and (S) are Low and (CE) is High during the High-to-Low clock transition.

This flip-flop is asynchronously cleared, outputs Low, when power is applied. For FPGA devices, power-on conditions are simulated when global set/reset (GSR) is active. GSR defaults to active-High but can be inverted by adding an inverter in front of the GSR input of the appropriate *STARTUP\_architecture* symbol.

### Logic Table

Inputs					Outputs
R	S	CE	D	C	Q
1	X	X	X	↓	0
0	1	X	X	↓	1
0	0	0	X	X	No Change
0	0	1	D	↓	D

### Design Entry Method

This design element can be used in schematics.

### Available Attributes

Attribute	Type	Allowed Values	Default	Description
INIT	1-Bit Binary	0 or 1	0	Sets the initial value of Q output after configuration and on GSR.

### For More Information

- See the [Spartan-3 User Guide](#).
- See the [Spartan-3 Data Sheets](#).

## FDS

Primitive: D Flip-Flop with Synchronous Set

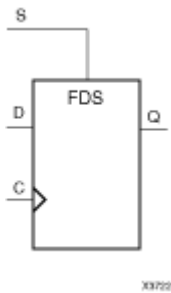

### Introduction

FDS is a single D-type flip-flop with data (D) and synchronous set (S) inputs and data output (Q). The synchronous set input, when High, sets the Q output High on the Low-to-High clock (C) transition. The data on the D input is loaded into the flip-flop when S is Low during the Low-to-High clock (C) transition.

For FPGA devices, this flip-flop is asynchronously preset, output High, when power is applied. Power-on conditions are simulated when global set/reset (GSR) is active. GSR defaults to active-High but can be inverted by adding an inverter in front of the GSR input of the appropriate `STARTUP_architecture` symbol.

### Logic Table

Inputs			Outputs
S	D	C	Q
1	X	↑	1
0	D	↑	D

### Design Entry Method

This design element is only for use in schematics.

### Available Attributes

Attribute	Type	Allowed Values	Default	Description
INIT	1-Bit Binary	0 or 1	0	Sets the initial value of Q output after configuration.

### For More Information

- See the [Spartan-3 User Guide](#).
- See the [Spartan-3 Data Sheets](#).

## FDS\_1

Primitive: D Flip-Flop with Negative-Edge Clock and Synchronous Set

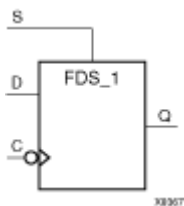

### Introduction

FDS is a single D-type flip-flop with data (D) and synchronous set (S) inputs and data output (Q). The synchronous set input, when High, sets the Q output High on the Low-to-High clock (C) transition. The data on the D input is loaded into the flip-flop when S is Low during the Low-to-High clock (C) transition.

This flip-flop is asynchronously preset, output High, when power is applied. For FPGA devices, power-on conditions are simulated when global set/reset (GSR) is active. GSR defaults to active-High but can be inverted by adding an inverter in front of the GSR input of the appropriate `STARTUP_architecture` symbol.

### Logic Table

Inputs			Outputs
S	D	C	Q
1	X	↓	1
0	D	↓	D

### Design Entry Method

This design element is only for use in schematics.

### Available Attributes

Attribute	Type	Allowed Values	Default	Description
INIT	1-Bit Binary	0 or 1	0	Sets the initial value of Q output after configuration.

### For More Information

- See the [Spartan-3 User Guide](#).
- See the [Spartan-3 Data Sheets](#).

## FDSE

Primitive: D Flip-Flop with Clock Enable and Synchronous Set

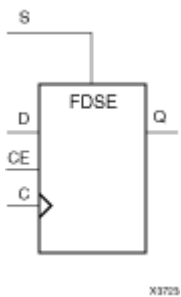

### Introduction

FDSE is a single D-type flip-flop with data (D), clock enable (CE), and synchronous set (S) inputs and data output (Q). The synchronous set (S) input, when High, overrides the clock enable (CE) input and sets the Q output High during the Low-to-High clock (C) transition. The data on the D input is loaded into the flip-flop when S is Low and CE is High during the Low-to-High clock (C) transition.

For FPGA devices, this flip-flop is asynchronously preset, output High, when power is applied. Power-on conditions are simulated when global set/reset (GSR) is active. GSR defaults to active-High but can be inverted by adding an inverter in front of the GSR input of the appropriate `STARTUP_architecture` symbol.

### Logic Table

Inputs				Outputs
S	CE	D	C	Q
1	X	X	↑	1
0	0	X	X	No Change
0	1	D	↑	D

### Design Entry Method

This design element is only for use in schematics.

### Available Attributes

Attribute	Type	Allowed Values	Default	Description
INIT	1-Bit Binary	0 or 1	0	Sets the initial value of Q output after configuration.

### For More Information

- See the [Spartan-3 User Guide](#).
- See the [Spartan-3 Data Sheets](#).

## FDSE\_1

Primitive: D Flip-Flop with Negative-Edge Clock, Clock Enable, and Synchronous Set

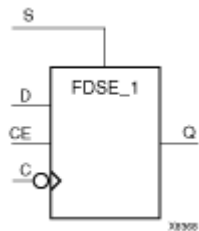

### Introduction

FDSE\_1 is a single D-type flip-flop with data (D), clock enable (CE), and synchronous set (S) inputs and data output (Q). The synchronous set (S) input, when High, overrides the clock enable (CE) input and sets the Q output High during the High-to-Low clock (C) transition. The data on the D input is loaded into the flip-flop when S is Low and CE is High during the High-to-Low clock (C) transition.

This flip-flop is asynchronously preset, output High, when power is applied. For FPGA devices, power-on conditions are simulated when global set/reset (GSR) is active. GSR defaults to active-High but can be inverted by adding an inverter in front of the GSR input of the appropriate *STARTUP\_architecture* symbol.

### Logic Table

Inputs				Outputs
S	CE	D	C	Q
1	X	X	↓	1
0	0	X	X	No Change
0	1	D	↓	D

### Design Entry Method

This design element is only for use in schematics.

### Available Attributes

Attribute	Type	Allowed Values	Default	Description
INIT	1-Bit Binary	0 or 1	0	Sets the initial value of Q output after configuration.

### For More Information

- See the [Spartan-3 User Guide](#).
- See the [Spartan-3 Data Sheets](#).

## FJKC

Macro: J-K Flip-Flop with Asynchronous Clear

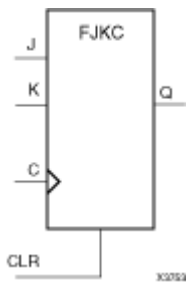

### Introduction

This design element is a single J-K-type flip-flop with J, K, and asynchronous clear (CLR) inputs and data output (Q). The asynchronous clear (CLR) input, when High, overrides all other inputs and resets the Q output Low. When CLR is Low, the output responds to the state of the J and K inputs, as shown in the following logic table, during the Low-to-High clock (C) transition.

This flip-flop is asynchronously cleared, outputs Low, when power is applied. For FPGA devices, power-on conditions are simulated when global set/reset (GSR) is active. GSR defaults to active-High but can be inverted by adding an inverter in front of the GSR input of the appropriate *STARTUP\_architecture* symbol.

### Logic Table

Inputs				Outputs
CLR	J	K	C	Q
1	X	X	X	0
0	0	0	↑	No Change
0	0	1	↑	0
0	1	0	↑	1
0	1	1	↑	Toggle

### Design Entry Method

This design element is only for use in schematics.

### For More Information

- See the [Spartan-3 User Guide](#).
- See the [Spartan-3 Data Sheets](#).

## FJKCE

Macro: J-K Flip-Flop with Clock Enable and Asynchronous Clear

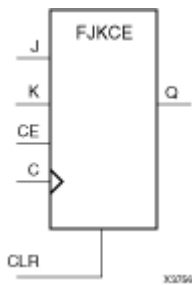

### Introduction

This design element is a single J-K-type flip-flop with J, K, clock enable (CE), and asynchronous clear (CLR) inputs and data output (Q). The asynchronous clear (CLR), when High, overrides all other inputs and resets the Q output Low. When CLR is Low and CE is High, Q responds to the state of the J and K inputs, as shown in the following logic table, during the Low-to-High clock transition. When CE is Low, the clock transitions are ignored.

This flip-flop is asynchronously cleared, outputs Low, when power is applied. For FPGA devices, power-on conditions are simulated when global set/reset (GSR) is active. GSR defaults to active-High but can be inverted by adding an inverter in front of the GSR input of the appropriate *STARTUP\_architecture* symbol.

### Logic Table

Inputs					Outputs
CLR	CE	J	K	C	Q
1	X	X	X	X	0
0	0	X	X	X	No Change
0	1	0	0	X	No Change
0	1	0	1	↑	0
0	1	1	0	↑	1
0	1	1	1	↑	Toggle

### Design Entry Method

This design element is only for use in schematics.

### For More Information

- See the [Spartan-3 User Guide](#).
- See the [Spartan-3 Data Sheets](#).

## FJKP

Macro: J-K Flip-Flop with Asynchronous Preset

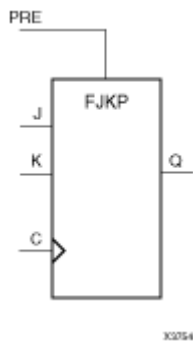

### Introduction

This design element is a single J-K-type flip-flop with J, K, and asynchronous preset (PRE) inputs and data output (Q). The asynchronous preset (PRE) input, when High, overrides all other inputs and sets the (Q) output High. When (PRE) is Low, the (Q) output responds to the state of the J and K inputs, as shown in the following logic table, during the Low-to-High clock transition.

For FPGA devices, this flip-flop is asynchronously preset, output High, when power is applied. Power-on conditions are simulated when global set/reset (GSR) is active. GSR defaults to active-High but can be inverted by adding an inverter in front of the GSR input of the appropriate `STARTUP_architecture` symbol.

### Logic Table

Inputs				Outputs
PRE	J	K	C	Q
1	X	X	X	1
0	0	0	X	No Change
0	0	1	↑	0
0	1	0	↑	1
0	1	1	↑	Toggle

### Design Entry Method

This design element is only for use in schematics.

### For More Information

- See the [Spartan-3 User Guide](#).
- See the [Spartan-3 Data Sheets](#).



## FJKPE

Macro: J-K Flip-Flop with Clock Enable and Asynchronous Preset

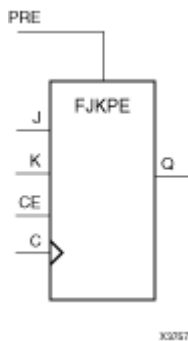

### Introduction

This design element is a single J-K-type flip-flop with J, K, clock enable (CE), and asynchronous preset (PRE) inputs and data output (Q). The asynchronous preset (PRE), when High, overrides all other inputs and sets the (Q) output High. When (PRE) is Low and (CE) is High, the (Q) output responds to the state of the J and K inputs, as shown in the logic table, during the Low-to-High clock (C) transition. When (CE) is Low, clock transitions are ignored.

For FPGA devices, this flip-flop is asynchronously preset, output High, when power is applied. Power-on conditions are simulated when global set/reset (GSR) is active. GSR defaults to active-High but can be inverted by adding an inverter in front of the GSR input of the appropriate `STARTUP_architecture` symbol.

### Logic Table

Inputs					Outputs
PRE	CE	J	K	C	Q
1	X	X	X	X	1
0	0	X	X	X	No Change
0	1	0	0	X	No Change
0	1	0	1	↑	0
0	1	1	0	↑	1
0	1	1	1	↑	Toggle

### Design Entry Method

This design element is only for use in schematics.

### For More Information

- See the [Spartan-3 User Guide](#).
- See the [Spartan-3 Data Sheets](#).

## FJKRSE

Macro: J-K Flip-Flop with Clock Enable and Synchronous Reset and Set

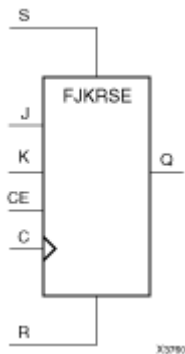

### Introduction

This design element is a single J-K-type flip-flop with J, K, synchronous reset (R), synchronous set (S), and clock enable (CE) inputs and data output (Q). When synchronous reset (R) is High during the Low-to-High clock (C) transition, all other inputs are ignored and output (Q) is reset Low. When synchronous set (S) is High and (R) is Low, output (Q) is set High. When (R) and (S) are Low and (CE) is High, output (Q) responds to the state of the J and K inputs, according to the following logic table, during the Low-to-High clock (C) transition. When (CE) is Low, clock transitions are ignored.

This flip-flop is asynchronously cleared, outputs Low, when power is applied. For FPGA devices, power-on conditions are simulated when global set/reset (GSR) is active. GSR defaults to active-High but can be inverted by adding an inverter in front of the GSR input of the appropriate `STARTUP_architecture` symbol.

### Logic Table

Inputs						Outputs
R	S	CE	J	K	C	Q
1	X	X	X	X	↑	0
0	1	X	X	X	↑	1
0	0	0	X	X	X	No Change
0	0	1	0	0	X	No Change
0	0	1	0	1	↑	0
0	0	1	1	1	↑	Toggle
0	0	1	1	0	↑	1

### Design Entry Method

This design element is only for use in schematics.

### For More Information

- See the [Spartan-3 User Guide](#).
- See the [Spartan-3 Data Sheets](#).

## FJKSRE

Macro: J-K Flip-Flop with Clock Enable and Synchronous Set and Reset

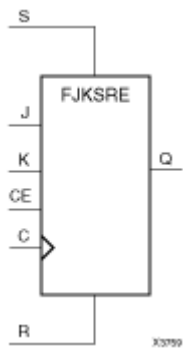

### Introduction

This design element is a single J-K-type flip-flop with J, K, synchronous set (S), synchronous reset (R), and clock enable (CE) inputs and data output (Q). When synchronous set (S) is High during the Low-to-High clock (C) transition, all other inputs are ignored and output (Q) is set High. When synchronous reset (R) is High and (S) is Low, output (Q) is reset Low. When (S) and (R) are Low and (CE) is High, output (Q) responds to the state of the J and K inputs, as shown in the following logic table, during the Low-to-High clock (C) transition. When (CE) is Low, clock transitions are ignored.

This flip-flop is asynchronously cleared, outputs Low, when power is applied. For FPGA devices, power-on conditions are simulated when global set/reset (GSR) is active. GSR defaults to active-High but can be inverted by adding an inverter in front of the GSR input of the appropriate `STARTUP_architecture` symbol.

### Logic Table

Inputs						Outputs
S	R	CE	J	K	C	Q
1	X	X	X	X	↑	1
0	1	X	X	X	↑	0
0	0	0	X	X	X	No Change
0	0	1	0	0	X	No Change
0	0	1	0	1	↑	0
0	0	1	1	0	↑	1
0	0	1	1	1	↑	Toggle

### Design Entry Method

This design element is only for use in schematics.

### For More Information

- See the [Spartan-3 User Guide](#).
- See the [Spartan-3 Data Sheets](#).

## FMAP

Primitive: F Function Generator Partitioning Control Symbol

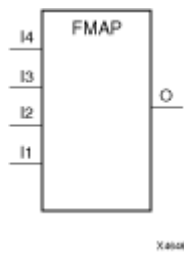

### Introduction

The FMAP symbol is used to map logic to the function generator of a slice. See the appropriate CAE tool interface user guide for information about specifying this attribute in your schematic design editor.

The MAP=*type* parameter can be used with the FMAP symbol to further define how much latitude you want to give the mapping program. The following table shows MAP option characters and their meanings

MAP Option Character	Function
P	Pins.
C	Closed — Adding logic to or removing logic from the CLB is not allowed.
L	Locked — Locking CLB pins.
O	Open — Adding logic to or removing logic from the CLB is allowed.
U	Unlocked — No locking on CLB pins.

Possible types of MAP parameters for FMAP are MAP=PUC, MAP=PLC, MAP=PLO, and MAP=PUO. The default parameter is PUO. If one of the “open” parameters is used (PLO or PUO), only the output signals must be specified.

**Note** Currently, only PUC and PUO are observed. PLC and PLO are translated into PUC and PUO, respectively.

The FMAP symbol can be assigned to specific CLB locations using LOC attributes.

### Design Entry Method

This design element is only for use in schematics.

### For More Information

- See the [Spartan-3 User Guide](#).
- See the [Spartan-3 Data Sheets](#).

## FTC

Macro: Toggle Flip-Flop with Asynchronous Clear

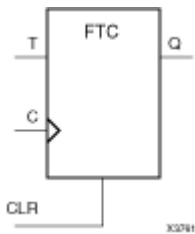

### Introduction

This design element is a synchronous, resettable toggle flip-flop. The asynchronous clear (CLR) input, when High, overrides all other inputs and resets the data output (Q) Low. The (Q) output toggles, or changes state, when the toggle enable (T) input is High and (CLR) is Low during the Low-to-High clock transition.

This flip-flop is asynchronously cleared, outputs Low, when power is applied. For FPGA devices, power-on conditions are simulated when global set/reset (GSR) is active. GSR defaults to active-High but can be inverted by adding an inverter in front of the GSR input of the appropriate `STARTUP_architecture` symbol.

### Logic Table

Inputs			Outputs
CLR	T	C	Q
1	X	X	0
0	0	X	No Change
0	1	↑	Toggle

### Design Entry Method

You can instantiate this element when targeting a CPLD, but not when you are targeting an FPGA.

### For More Information

- See the [Spartan-3 User Guide](#).
- See the [Spartan-3 Data Sheets](#).

## FTCE

Macro: Toggle Flip-Flop with Clock Enable and Asynchronous Clear

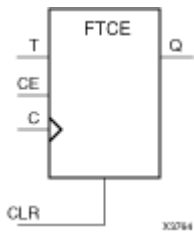

### Introduction

This design element is a toggle flip-flop with toggle and clock enable and asynchronous clear. When the asynchronous clear (CLR) input is High, all other inputs are ignored and the data output (Q) is reset Low. When CLR is Low and toggle enable (T) and clock enable (CE) are High, Q output toggles, or changes state, during the Low-to-High clock (C) transition. When CE is Low, clock transitions are ignored.

This flip-flop is asynchronously cleared, outputs Low, when power is applied. For FPGA devices, power-on conditions are simulated when global set/reset (GSR) is active. GSR defaults to active-High but can be inverted by adding an inverter in front of the GSR input of the appropriate *STARTUP\_architecture* symbol.

### Logic Table

Inputs				Outputs
CLR	CE	T	C	Q
1	X	X	X	0
0	0	X	X	No Change
0	1	0	X	No Change
0	1	1	↑	Toggle

### Design Entry Method

This design element is only for use in schematics.

### For More Information

- See the [Spartan-3 User Guide](#).
- See the [Spartan-3 Data Sheets](#).

## FTCLE

Macro: Toggle/Loadable Flip-Flop with Clock Enable and Asynchronous Clear

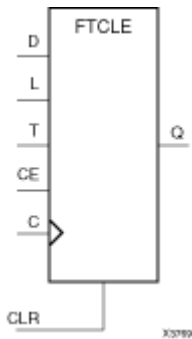

### Introduction

This design element is a toggle/loadable flip-flop with toggle and clock enable and asynchronous clear. When the asynchronous clear input (CLR) is High, all other inputs are ignored and output Q is reset Low. When load enable input (L) is High and CLR is Low, clock enable (CE) is overridden and the data on data input (D) is loaded into the flip-flop during the Low-to-High clock (C) transition. When toggle enable (T) and CE are High and L and CLR are Low, output Q toggles, or changes state, during the Low- to-High clock transition. When CE is Low, clock transitions are ignored.

This flip-flop is asynchronously cleared, outputs Low, when power is applied. For FPGA devices, power-on conditions are simulated when global set/reset (GSR) is active. GSR defaults to active-High but can be inverted by adding an inverter in front of the GSR input of the appropriate `STARTUP_architecture` symbol.

### Logic Table

Inputs						Outputs
CLR	L	CE	T	D	C	Q
1	X	X	X	X	X	0
0	1	X	X	D	↑	D
0	0	0	X	X	X	No Change
0	0	1	0	X	X	No Change
0	0	1	1	X	↑	Toggle

### Design Entry Method

This design element is only for use in schematics.

### For More Information

- See the [Spartan-3 User Guide](#).
- See the [Spartan-3 Data Sheets](#).

## FTCLEX

Macro: Toggle/Loadable Flip-Flop with Clock Enable and Asynchronous Clear

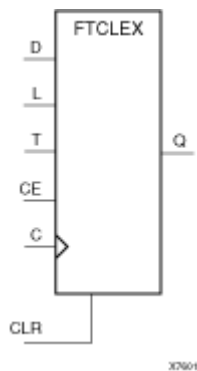

### Introduction

This design element is a toggle/loadable flip-flop with toggle and clock enable and asynchronous clear. When the asynchronous clear input (CLR) is High, all other inputs are ignored and output Q is reset Low. When load enable input (L) is High, CLR is Low, and CE is High, the data on data input (D) is loaded into the flip-flop during the Low-to-High clock (C) transition. When toggle enable (T) and CE are High and L and CLR are Low, output Q toggles, or changes state, during the Low- to-High clock transition. When CE is Low, clock transitions are ignored.

This flip-flop is asynchronously cleared, outputs Low, when power is applied. For FPGA devices, power-on conditions are simulated when global set/reset (GSR) is active. GSR defaults to active-High but can be inverted by adding an inverter in front of the GSR input of the appropriate `STARTUP_architecture` symbol.

### Logic Table

Inputs						Outputs
CLR	L	CE	T	D	C	Q
1	X	X	X	X	X	0
0	1	X	X	D	↑	D
0	0	0	X	X	X	No Change
0	0	1	0	X	X	No Change
0	0	1	1	X	↑	Toggle

### Design Entry Method

This design element is only for use in schematics.

### For More Information

- See the [Spartan-3 User Guide](#).
- See the [Spartan-3 Data Sheets](#).



## FTP

### Macro: Toggle Flip-Flop with Asynchronous Preset

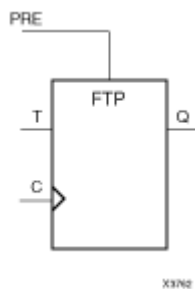

### Introduction

This design element is a toggle flip-flop with toggle enable and asynchronous preset. When the asynchronous preset (PRE) input is High, all other inputs are ignored and output (Q) is set High. When toggle-enable input (T) is High and (PRE) is Low, output (Q) toggles, or changes state, during the Low-to-High clock (C) transition.

For FPGA devices, this flip-flop is asynchronously preset, output High, when power is applied. Power-on conditions are simulated when global set/reset (GSR) is active. GSR defaults to active-High but can be inverted by adding an inverter in front of the GSR input of the appropriate `STARTUP_architecture` symbol.

### Logic Table

Inputs			Outputs
PRE	T	C	Q
1	X	X	1
0	0	X	No Change
0	1	↑	Toggle

### Design Entry Method

This design element is only for use in schematics.

### For More Information

- See the [Spartan-3 User Guide](#).
- See the [Spartan-3 Data Sheets](#).

## FTPE

Macro: Toggle Flip-Flop with Clock Enable and Asynchronous Preset

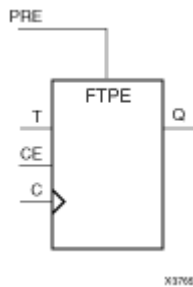

### Introduction

This design element is a toggle flip-flop with toggle and clock enable and asynchronous preset. When the asynchronous preset (PRE) input is High, all other inputs are ignored and output (Q) is set High. When the toggle enable input (T) is High, clock enable (CE) is High, and (PRE) is Low, output (Q) toggles, or changes state, during the Low-to-High clock transition. When (CE) is Low, clock transitions are ignored.

For FPGA devices, this flip-flop is asynchronously preset, output High, when power is applied. Power-on conditions are simulated when global set/reset (GSR) is active. GSR defaults to active-High but can be inverted by adding an inverter in front of the GSR input of the appropriate `STARTUP_architecture` symbol.

### Logic Table

Inputs				Outputs
PRE	CE	T	C	Q
1	X	X	X	1
0	0	X	X	No Change
0	1	0	X	No Change
0	1	1	↑	Toggle

### Design Entry Method

This design element is only for use in schematics.

### For More Information

- See the [Spartan-3 User Guide](#).
- See the [Spartan-3 Data Sheets](#).

## FTPLE

Macro: Toggle/Loadable Flip-Flop with Clock Enable and Asynchronous Preset

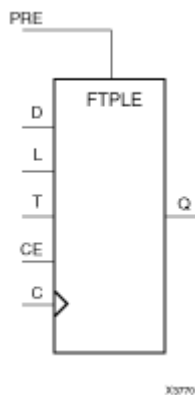

### Introduction

This design element is a toggle/loadable flip-flop with toggle and clock enable and asynchronous preset. When the asynchronous preset input (PRE) is High, all other inputs are ignored and output (Q) is set High. When the load enable input (L) is High and (PRE) is Low, the clock enable (CE) is overridden and the data (D) is loaded into the flip-flop during the Low-to-High clock transition. When L and PRE are Low and toggle-enable input (T) and (CE) are High, output (Q) toggles, or changes state, during the Low-to-High clock transition. When (CE) is Low, clock transitions are ignored.

For FPGA devices, this flip-flop is asynchronously preset, output High, when power is applied. Power-on conditions are simulated when global set/reset (GSR) is active. GSR defaults to active-High but can be inverted by adding an inverter in front of the GSR input of the appropriate `STARTUP_architecture` symbol.

### Logic Table

Inputs						Outputs
PRE	L	CE	T	D	C	Q
1	X	X	X	X	X	1
0	1	X	X	D	?	D
0	0	0	X	X	X	No Change
0	0	1	0	X	X	No Change
0	0	1	1	X	?	Toggle

### Design Entry Method

This design element is only for use in schematics.

### For More Information

- See the [Spartan-3 User Guide](#).
- See the [Spartan-3 Data Sheets](#).

## FTRSE

Macro: Toggle Flip-Flop with Clock Enable and Synchronous Reset and Set

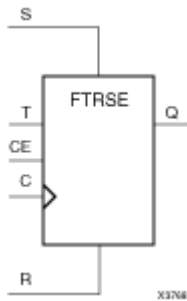

### Introduction

This design element is a toggle flip-flop with toggle and clock enable and synchronous reset and set. When the synchronous reset input (R) is High, it overrides all other inputs and the data output (Q) is reset Low. When the synchronous set input (S) is High and (R) is Low, clock enable input (CE) is overridden and output (Q) is set High. (Reset has precedence over Set.) When toggle enable input (T) and (CE) are High and (R) and (S) are Low, output (Q) toggles, or changes state, during the Low-to-High clock transition.

This flip-flop is asynchronously cleared, outputs Low, when power is applied. For FPGA devices, power-on conditions are simulated when global set/reset (GSR) is active. GSR defaults to active-High but can be inverted by adding an inverter in front of the GSR input of the appropriate `STARTUP_architecture` symbol.

### Logic Table

Inputs					Outputs
R	S	CE	T	C	Q
1	X	X	X	↑	0
0	1	X	X	↑	1
0	0	0	X	X	No Change
0	0	1	0	X	No Change
0	0	1	1	↑	Toggle

### Design Entry Method

This design element is only for use in schematics.

### For More Information

- See the [Spartan-3 User Guide](#).
- See the [Spartan-3 Data Sheets](#).

## FTRSLE

Macro: Toggle/Loadable Flip-Flop with Clock Enable and Synchronous Reset and Set

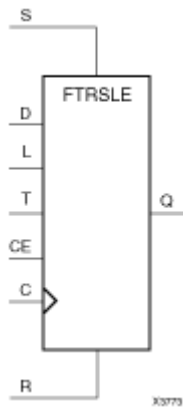

### Introduction

This design element is a toggle/loadable flip-flop with toggle and clock enable and synchronous reset and set. The synchronous reset input (R), when High, overrides all other inputs and resets the data output (Q) Low. (Reset has precedence over Set.) When R is Low and synchronous set input (S) is High, the clock enable input (CE) is overridden and output Q is set High. When R and S are Low and load enable input (L) is High, CE is overridden and data on data input (D) is loaded into the flip-flop during the Low-to-High clock transition. When R, S, and L are Low, CE is High and T is High, output Q toggles, or changes state, during the Low-to-High clock transition. When CE is Low, clock transitions are ignored.

This flip-flop is asynchronously cleared, outputs Low, when power is applied. For FPGA devices, power-on conditions are simulated when global set/reset (GSR) is active. GSR defaults to active-High but can be inverted by adding an inverter in front of the GSR input of the appropriate `STARTUP_architecture` symbol.

### Logic Table

Inputs							Outputs
R	S	L	CE	T	D	C	Q
1	0	X	X	X	X	↑	0
0	1	X	X	X	X	↑	1
0	0	1	X	X	1	↑	1
0	0	1	X	X	0	↑	0
0	0	0	0	X	X	X	No Change
0	0	0	1	0	X	X	No Change
0	0	0	1	1	X	↑	Toggle

### Design Entry Method

This design element is only for use in schematics.

### For More Information

- See the [Spartan-3 User Guide](#).
- See the [Spartan-3 Data Sheets](#).

## FTSRE

Macro: Toggle Flip-Flop with Clock Enable and Synchronous Set and Reset

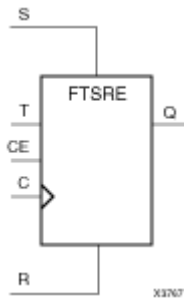

### Introduction

This design element is a toggle flip-flop with toggle and clock enable and synchronous set and reset. The synchronous set input, when High, overrides all other inputs and sets data output (Q) High. (Set has precedence over Reset.) When synchronous reset input (R) is High and S is Low, clock enable input (CE) is overridden and output Q is reset Low. When toggle enable input (T) and CE are High and S and R are Low, output Q toggles, or changes state, during the Low-to-High clock transition. When CE is Low, clock transitions are ignored.

This flip-flop is asynchronously cleared, outputs Low, when power is applied. For FPGA devices, power-on conditions are simulated when global set/reset (GSR) is active. GSR defaults to active-High but can be inverted by adding an inverter in front of the GSR input of the appropriate `STARTUP_architecture` symbol.

### Logic Table

Inputs					Outputs
S	R	CE	T	C	Q
1	X	X	X	↑	1
0	1	X	X	↑	0
0	0	0	X	X	No Change
0	0	1	0	X	No Change
0	0	1	1	↑	Toggle

### Design Entry Method

This design element is only for use in schematics.

### For More Information

- See the [Spartan-3 User Guide](#).
- See the [Spartan-3 Data Sheets](#).

## FTSRLE

Macro: Toggle/Loadable Flip-Flop with Clock Enable and Synchronous Set and Reset

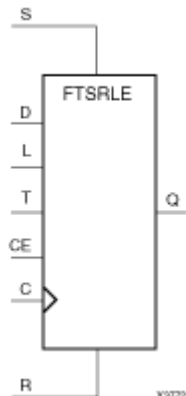

### Introduction

This design element is a toggle/loadable flip-flop with toggle and clock enable and synchronous set and reset. The synchronous set input (S), when High, overrides all other inputs and sets data output (Q) High. (Set has precedence over Reset.) When synchronous reset (R) is High and (S) is Low, clock enable input (CE) is overridden and output (Q) is reset Low. When load enable input (L) is High and S and R are Low, CE is overridden and data on data input (D) is loaded into the flip-flop during the Low-to-High clock transition. When the toggle enable input (T) and (CE) are High and (S), (R), and (L) are Low, output (Q) toggles, or changes state, during the Low-to-High clock transition. When (CE) is Low, clock transitions are ignored.

For FPGA devices, power-on conditions are simulated when global set/reset (GSR) is active. GSR defaults to active-High but can be inverted by adding an inverter in front of the GSR input of the appropriate `STARTUP_architecture` symbol.

### Logic Table

Inputs							Outputs
S	R	L	CE	T	D	C	Q
1	X	X	X	X	X	↑	1
0	1	X	X	X	X	↑	0
0	0	1	X	X	1	↑	1
0	0	1	X	X	0	↑	0
0	0	0	0	X	X	X	No Change
0	0	0	1	0	X	X	No Change
0	0	0	1	1	X	↑	Toggle

### Design Entry Method

This design element is only for use in schematics.

### For More Information

- See the [Spartan-3 User Guide](#).
- See the [Spartan-3 Data Sheets](#).

# GND

Primitive: Ground-Connection Signal Tag



## Introduction

The GND signal tag, or parameter, forces a net or input function to a Low logic level. A net tied to GND cannot have any other source.

When the logic-trimming software or fitter encounters a net or input function tied to GND, it removes any logic that is disabled by the GND signal. The GND signal is only implemented when the disabled logic cannot be removed.

## Design Entry Method

This design element is only for use in schematics.

## For More Information

- See the [Spartan-3 User Guide](#).
- See the [Spartan-3 Data Sheets](#).



## IBUF

Primitive: Input Buffer

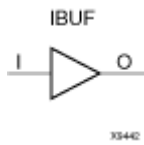

### Introduction

This design element is automatically inserted (inferred) by the synthesis tool to any signal directly connected to a top-level input or in-out port of the design. You should generally let the synthesis tool infer this buffer. However, it can be instantiated into the design if required. In order to do so, connect the input port (I) directly to the associated top-level input or in-out port, and connect the output port (O) to the logic sourced by that port. Modify any necessary generic maps (VHDL) or named parameter value assignment (Verilog) in order to change the default behavior of the component.

### Port Descriptions

Name	Direction	Width	Function
O	Output	1-Bit	Buffer input
I	Input	1-Bit	Buffer output

### Design Entry Method

This design element can be used in schematics.

In general, this element is inferred by the synthesis tool for any specified top-level input port to the design. It is generally not necessary to specify them in the source code however if desired, they be manually instantiated by either copying the instantiation code from the ISE Libraries Guide HDL Template and paste it into the top-level entity/module of your code. It is recommended to always put all I/O components on the top-level of the design to help facilitate hierarchical design methods. Connect the I port directly to the top-level input port of the design and the O port to the logic in which this input is to source. Specify the desired generic/defparam values in order to configure the proper behavior of the buffer.

### Available Attributes

Attribute	Type	Allowed Values	Default	Description
IOSTANDARD	String	See Note Below	DEFAULT	Sets the programmable I/O standard for the input.
IBUF_DELAY_VALUE	Binary	0 thru 12	0	Specifies the amount of additional delay to add to the non-registered path out of the IOB
IFD_DELAY_VALUE	Binary	AUTO, 0 thru 6	AUTO	Specifies the amount of additional delay to add to the registered path within the IOB

**Note** Consult the device user guide or databook for the allowed values and the default value.

## For More Information

- See the [Spartan-3 User Guide](#).
- See the [Spartan-3 Data Sheets](#).

## IBUF16

Macro: 16-Bit Input Buffer

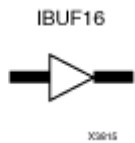

### Introduction

Input Buffers isolate the internal circuit from the signals coming into the chip. This design element is contained in input/output blocks (IOBs) and allows the specification of the particular I/O Standard to configure the I/O. In general, an this element should be used for all single-ended data input or bidirectional pins.

### Design Entry Method

This design element can be used in schematics.

In general, this element is inferred by the synthesis tool for any specified top-level input port to the design. It is generally not necessary to specify them in the source code however if desired, they be manually instantiated by either copying the instantiation code from the ISE Libraries Guide HDL Template and paste it into the top-level entity/module of your code. It is recommended to always put all I/O components on the top-level of the design to help facilitate hierarchical design methods. Connect the I port directly to the top-level input port of the design and the O port to the logic in which this input is to source. Specify the desired generic/defparam values in order to configure the proper behavior of the buffer.

### Available Attributes

Attribute	Type	Allowed Values	Default	Description
IOSTANDARD	String	See Note Below	DEFAULT	Sets the programmable I/O standard for the input.
IBUF_DELAY_VALUE	Binary	0 thru 12	0	Specifies the amount of additional delay to add to the non-registered path out of the IOB
IFD_DELAY_VALUE	Binary	AUTO, 0 thru 6	AUTO	Specifies the amount of additional delay to add to the registered path within the IOB

**Note** Consult the device user guide or databook for the allowed values and the default value.

### For More Information

- See the [Spartan-3 User Guide](#).
- See the [Spartan-3 Data Sheets](#).

## IBUF4

Macro: 4-Bit Input Buffer

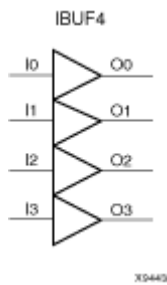

### Introduction

Input Buffers isolate the internal circuit from the signals coming into the chip. This design element is contained in input/output blocks (IOBs) and allows the specification of the particular I/O Standard to configure the I/O. In general, an this element should be used for all single-ended data input or bidirectional pins.

### Design Entry Method

This design element can be used in schematics.

In general, this element is inferred by the synthesis tool for any specified top-level input port to the design. It is generally not necessary to specify them in the source code however if desired, they be manually instantiated by either copying the instantiation code from the ISE Libraries Guide HDL Template and paste it into the top-level entity/module of your code. It is recommended to always put all I/O components on the top-level of the design to help facilitate hierarchical design methods. Connect the I port directly to the top-level input port of the design and the O port to the logic in which this input is to source. Specify the desired generic/defparam values in order to configure the proper behavior of the buffer.

### Available Attributes

Attribute	Type	Allowed Values	Default	Description
IOSTANDARD	String	See Note Below	DEFAULT	Sets the programmable I/O standard for the input.
IBUF_DELAY_VALUE	Binary	0 thru 12	0	Specifies the amount of additional delay to add to the non-registered path out of the IOB
IFD_DELAY_VALUE	Binary	AUTO, 0 thru 6	AUTO	Specifies the amount of additional delay to add to the registered path within the IOB

**Note** Consult the device user guide or databook for the allowed values and the default value.

### For More Information

- See the [Spartan-3 User Guide](#).
- See the [Spartan-3 Data Sheets](#).

## IBUF8

Macro: 8-Bit Input Buffer

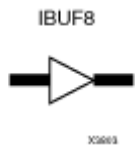

### Introduction

Input Buffers isolate the internal circuit from the signals coming into the chip. This design element is contained in input/output blocks (IOBs) and allows the specification of the particular I/O Standard to configure the I/O. In general, an this element should be used for all single-ended data input or bidirectional pins.

### Design Entry Method

This design element can be used in schematics.

In general, this element is inferred by the synthesis tool for any specified top-level input port to the design. It is generally not necessary to specify them in the source code however if desired, they be manually instantiated by either copying the instantiation code from the ISE Libraries Guide HDL Template and paste it into the top-level entity/module of your code. It is recommended to always put all I/O components on the top-level of the design to help facilitate hierarchical design methods. Connect the I port directly to the top-level input port of the design and the O port to the logic in which this input is to source. Specify the desired generic/defparam values in order to configure the proper behavior of the buffer.

### Available Attributes

Attribute	Type	Allowed Values	Default	Description
IOSTANDARD	String	See Note Below	DEFAULT	Sets the programmable I/O standard for the input.
IBUF_DELAY_VALUE	Binary	0 thru 12	0	Specifies the amount of additional delay to add to the non-registered path out of the IOB
IFD_DELAY_VALUE	Binary	AUTO, 0 thru 6	AUTO	Specifies the amount of additional delay to add to the registered path within the IOB

**Note** Consult the device user guide or databook for the allowed values and the default value.

### For More Information

- See the [Spartan-3 User Guide](#).
- See the [Spartan-3 Data Sheets](#).

## IBUFDS

Primitive: Differential Signaling Input Buffer with Optional Delay

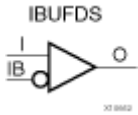

### Introduction

This design element is an input buffer that supports low-voltage, differential signaling. In IBUFDS, a design level interface signal is represented as two distinct ports (I and IB), one deemed the "master" and the other the "slave." The master and the slave are opposite phases of the same logical signal (for example, MYNET\_P and MYNET\_N). Optionally, a programmable differential termination feature is available to help improve signal integrity and reduce external components. Also available is a programmable delay to assist in the capturing of incoming data to the device.

### Logic Table

Inputs		Outputs
I	IB	O
0	0	No Change
0	1	0
1	0	1
1	1	No Change

### Port Descriptions

Name	Direction	Width	Function
O	Output	1-Bit	Diff_p Buffer input
IB	Input	1-Bit	Diff_n buffer input
I	Input	1-Bit	Buffer output

### Design Entry Method

This design element can be used in schematics.

Put all I/O components on the top-level of the design to help facilitate hierarchical design methods. Connect the I port directly to the top-level "master" input port of the design, the IB port to the top-level "slave" input port, and the O port to the logic in which this input is to source. Specify the desired generic/defparam values in order to configure the proper behavior of the buffer.

## Available Attributes

Attribute	Type	Allowed Values	Default	Description
IOSTANDARD	String	See Note Below	DEFAULT	Sets the programmable I/O standard for the IOB
IBUF_DELAY_VALUE	Binary	0 thru 12	0	Specifies the amount of additional delay for the IOB
IFD_DELAY_VALUE	Binary	AUTO, 0 thru 6	AUTO	Specifies the amount of additional delay for the IOB
DIFF_TERM	Boolean	TRUE or FALSE	FALSE	Enables the built-in differential termination

**Note** Consult the device user guide or databook for the allowed values and the default value.

## For More Information

- See the [Spartan-3 User Guide](#).
- See the [Spartan-3 Data Sheets](#).

## IBUFG

Primitive: Dedicated Input Clock Buffer

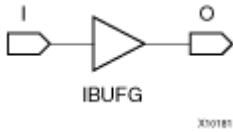

### Introduction

The IBUFG is a dedicated input to the device which should be used to connect incoming clocks to the FPGA to the global clock routing resources. The IBUFG provides dedicated connections to the DCM\_SP and BUFG providing the minimum amount of clock delay and jitter to the device. The IBUFG input can only be driven by the global clock pins. The IBUFG output can drive CLKIN of a DCM\_SP, BUFG, or your choice of logic. The IBUFG can be routed to your choice of logic to allow the use of the dedicated clock pins for general logic.

### Port Descriptions

Name	Direction	Width	Function
O	Output	1-Bit	Clock Buffer input
I	Input	1-Bit	Clock Buffer output

### Design Entry Method

This design element can be used in schematics.

### Available Attributes

Attribute	Type	Allowed Values	Default	Description
IOSTANDARD	String	See Note Below	"DEFAULT"	Sets the programmable I/O standard for the
IFD_DELAY_VALUE	Binary	AUTO, 0 thru 8	AUTO	Specifies the amount of additional delay to a within the IOB

**Note** Consult the device user guide or databook for the allowed values and the default value.

### For More Information

- See the [Spartan-3 User Guide](#).
- See the [Spartan-3 Data Sheets](#).



## IBUFGDS

Primitive: Differential Signaling Dedicated Input Clock Buffer and Optional Delay

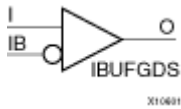

### Introduction

This design element is a dedicated differential signaling input buffer for connection to the clock buffer (BUFG) or DCM. In IBUFGDS, a design-level interface signal is represented as two distinct ports (I and IB), one deemed the "master" and the other the "slave." The master and the slave are opposite phases of the same logical signal (for example, MYNET\_P and MYNET\_N). Optionally, a programmable differential termination feature is available to help improve signal integrity and reduce external components. Also available is a programmable delay to assist in the capturing of incoming data to the device.

### Logic Table

Inputs		Outputs
I	IB	O
0	0	No Change
0	1	0
1	0	1
1	1	No Change

### Port Descriptions

Name	Direction	Width	Function
O	Output	1-Bit	Diff_p Clock Buffer Input
IB	Input	1-Bit	Diff_n Clock Buffer Input
I	Input	1-Bit	Clock Buffer output

### Design Entry Method

This design element can be used in schematics.

Put all I/O components on the top-level of the design to help facilitate hierarchical design methods. Connect the I port directly to the top-level "master" input port of the design, the IB port to the top-level "slave" input port and the O port to a DCM, BUFG or logic in which this input is to source. Some synthesis tools infer the BUFG automatically if necessary, when connecting an IBUFG to the clock resources of the FPGA. Specify the desired generic/defparam values in order to configure the proper behavior of the buffer.

### Available Attributes

Attribute	Type	Allowed Values	Default	Description
IOSTANDARD	String	See Note Below	"DEFAULT"	Sets the programmable I/O standard for the in
IFD_DELAY_VALUE	Binary	AUTO, 0 thru 6	AUTO	Specifies the amount of additional delay to ad registered path within the IOB.
DIFF_TERM	Boolean	TRUE or FALSE	FALSE	Enables the built-in differential termination re

**Note** Consult the device user guide or databook for the allowed values and the default value.

---

## For More Information

- See the [Spartan-3 User Guide](#).
- See the [Spartan-3 Data Sheets](#).

## IFD

Macro: Input D Flip-Flop

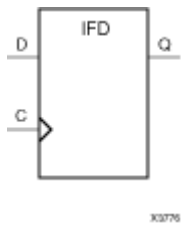

### Introduction

This D-type flip-flop is contained in an input/output block (IOB). The input (D) of the flip-flop is connected to an IPAD or an IOPAD (without using an IBUF). The (D) input provides data input for the flip-flop, which synchronizes data entering the chip. The data on input (D) is loaded into the flip-flop during the Low-to-High clock (C) transition and appears at the output (Q). The clock input can be driven by internal logic or through another external pin.

This flip-flop is asynchronously cleared, outputs Low, when power is applied. For FPGA devices, power-on conditions are simulated when global set/reset (GSR) is active. GSR defaults to active-High but can be inverted by adding an inverter in front of the GSR input of the appropriate *STARTUP\_architecture* symbol.

### Logic Table

Inputs		Outputs
D	C	Q
Dn	↑	Dn

### Design Entry Method

This design element is only for use in schematics.

### For More Information

- See the [Spartan-3 User Guide](#).
- See the [Spartan-3 Data Sheets](#).

## IFD\_1

Macro: Input D Flip-Flop with Inverted Clock (Asynchronous Preset)

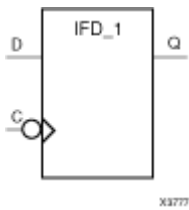

### Introduction

This design element is a D-type flip flop which is contained in an input/output block (IOB). The input (D) of the flip-flop is connected to an IPAD or an IOPAD. The D input also provides data input for the flip-flop, which synchronizes data entering the chip. The D input data is loaded into the flip-flop during the High-to-Low clock (C) transition and appears at the output (Q). The clock input can be driven by internal logic or through another external pin.

This flip-flop is asynchronously cleared, outputs Low, when power is applied. For FPGA devices, power-on conditions are simulated when global set/reset (GSR) is active. GSR defaults to active-High but can be inverted by adding an inverter in front of the GSR input of the appropriate *STARTUP\_architecture* symbol.

### Logic Table

Inputs		Outputs
D	C	Q
0	↓	0
1	↓	1

### Design Entry Method

This design element is only for use in schematics.

### For More Information

- See the [Spartan-3 User Guide](#).
- See the [Spartan-3 Data Sheets](#).

## IFD16

Macro: 16-Bit Input D Flip-Flop

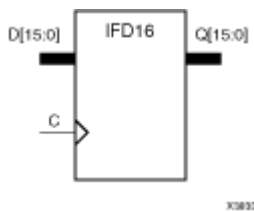

### Introduction

This D-type flip-flop is contained in an input/output block (IOB). The input (D) of the flip-flop is connected to an IPAD or an IOPAD (without using an IBUF). The (D) input provides data input for the flip-flop, which synchronizes data entering the chip. The data on input (D) is loaded into the flip-flop during the Low-to-High clock (C) transition and appears at the output (Q). The clock input can be driven by internal logic or through another external pin.

This flip-flop is asynchronously cleared, outputs Low, when power is applied. For FPGA devices, power-on conditions are simulated when global set/reset (GSR) is active. GSR defaults to active-High but can be inverted by adding an inverter in front of the GSR input of the appropriate *STARTUP\_architecture* symbol.

### Logic Table

Inputs		Outputs
D	C	Q
Dn	↑	Dn

### Design Entry Method

This design element is only for use in schematics.

### For More Information

- See the [Spartan-3 User Guide](#).
- See the [Spartan-3 Data Sheets](#).

## IFD4

Macro: 4-Bit Input D Flip-Flop

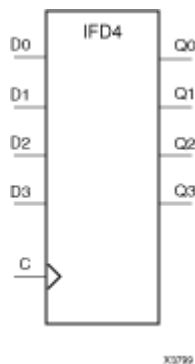

### Introduction

This D-type flip-flop is contained in an input/output block (IOB). The input (D) of the flip-flop is connected to an IPAD or an IOPAD (without using an IBUF). The (D) input provides data input for the flip-flop, which synchronizes data entering the chip. The data on input (D) is loaded into the flip-flop during the Low-to-High clock (C) transition and appears at the output (Q). The clock input can be driven by internal logic or through another external pin.

This flip-flop is asynchronously cleared, outputs Low, when power is applied. For FPGA devices, power-on conditions are simulated when global set/reset (GSR) is active. GSR defaults to active-High but can be inverted by adding an inverter in front of the GSR input of the appropriate `STARTUP_architecture` symbol.

### Logic Table

Inputs		Outputs
D	C	Q
D <sub>n</sub>	↑	D <sub>n</sub>

### Design Entry Method

This design element is only for use in schematics.

### For More Information

- See the [Spartan-3 User Guide](#).
- See the [Spartan-3 Data Sheets](#).

## IFD8

Macro: 8-Bit Input D Flip-Flop

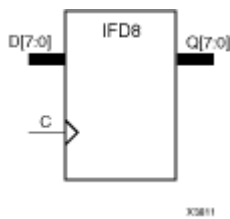

### Introduction

This D-type flip-flop is contained in an input/output block (IOB). The input (D) of the flip-flop is connected to an IPAD or an IOPAD (without using an IBUF). The (D) input provides data input for the flip-flop, which synchronizes data entering the chip. The data on input (D) is loaded into the flip-flop during the Low-to-High clock (C) transition and appears at the output (Q). The clock input can be driven by internal logic or through another external pin.

This flip-flop is asynchronously cleared, outputs Low, when power is applied. For FPGA devices, power-on conditions are simulated when global set/reset (GSR) is active. GSR defaults to active-High but can be inverted by adding an inverter in front of the GSR input of the appropriate `STARTUP_architecture` symbol.

### Logic Table

Inputs		Outputs
D	C	Q
Dn	↑	Dn

### Design Entry Method

This design element is only for use in schematics.

### For More Information

- See the [Spartan-3 User Guide](#).
- See the [Spartan-3 Data Sheets](#).



## IFDDRCPE

Primitive: Dual Data Rate Input D Flip-Flop with Clock Enable and Asynchronous Preset and Clear

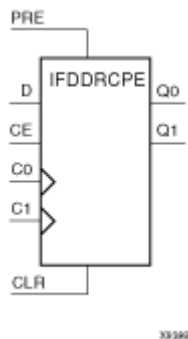

### Introduction

This design element is a dual data rate (DDR) input D flip-flop with clock enable (CE) and asynchronous preset (PRE) and clear (CLR). It consists of one input buffer and two identical flip-flops (FDCPE).

When the asynchronous PRE is High and CLR is Low, both the Q0 and Q1 outputs are set High. When CLR is High, both outputs are reset Low. When PRE and CLR are Low and CE is High, data on the D input is loaded into the Q0 output on the Low-to-High C0 clock transition, and into the Q1 output on the Low-to-High C1 clock transition.

The INIT attribute does not apply to this design elements components.

This flip-flop is asynchronously cleared, outputs Low, when power is applied. For FPGA devices, power-on conditions are simulated when global set/reset (GSR) is active. GSR defaults to active-High but can be inverted by adding an inverter in front of the GSR input of the appropriate `STARTUP_architecture` symbol.

### Logic Table

Inputs						Outputs	
C0	C1	CE	D	CLR	PRE	Q0	Q1
X	X	X	X	1	0	0	0
X	X	X	X	0	1	1	1
X	X	X	X	1	1	0	0
X	X	0	X	0	0	No Change	No Change
↑	X	1	D	0	0	D	No Change
X	↑	1	D	0	0	No Change	D

### Design Entry Method

This design element can be used in schematics.

### For More Information

- See the [Spartan-3 User Guide](#).
- See the [Spartan-3 Data Sheets](#).

## IFDDRSE

Primitive: Dual Data Rate Input D Flip-Flop with Synchronous Reset and Set and Clock Enable

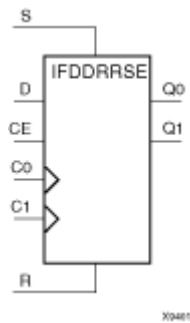

### Introduction

This design element is a dual data rate (DDR) input D flip-flop with synchronous reset (R), synchronous set (S), and clock enable (CE). It consists of one input buffer and two identical flip-flops (FDRSE).

For the C0 input and Q0 output, reset (R) has precedence. The R input, when High, resets the Q0 output Low during the Low-to-High C0 clock transition. When S is High and R is Low, the Q0 output is set High during the Low-to-High C0 clock transition. For the C1 input and Q1 output, set (S) has precedence. The R input, when High, resets the Q1 output Low during the Low-to-High C1 clock transition. When S is High and R is Low, the Q1 output is set to High during the Low-to-High C1 clock transition.

This flip-flop is asynchronously cleared, outputs Low, when power is applied. For FPGA devices, power-on conditions are simulated when global set/reset (GSR) is active. GSR defaults to active-High but can be inverted by adding an inverter in front of the GSR input of the appropriate `STARTUP_architecture` symbol.

The INIT attribute does not apply to this element.

### Logic Table

Inputs						Outputs	
C0	C1	CE	D	R	S	Q0	Q1
↑	X	X	X	1	0	0	No Change
↑	X	X	X	0	1	1	No Change
↑	X	X	X	1	1	0	No Change
X	↑	X	X	1	0	No Change	0
X	↑	X	X	0	1	No Change	1
X	↑	X	X	1	1	No Change	0
X	X	0	X	0	0	No Change	No Change
↑	X	1	D	0	0	D	No Change
X	↑	1	D	0	0	No Change	D

### Design Entry Method

This design element can be used in schematics.

---

## For More Information

- See the [Spartan-3 User Guide](#).
- See the [Spartan-3 Data Sheets](#).

## IFDI

Macro: Input D Flip-Flop (Asynchronous Preset)

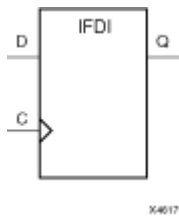

### Introduction

This design element is a D-type flip-flop which is contained in an input/output block (IOB). The input (D) of the flip-flop is connected to an IPAD or an IOPAD. The D input provides data input for the flip-flop, which synchronizes data entering the chip. The D input data is loaded into the flip-flop during the Low-to-High clock (C) transition and appears at the output (Q). The clock input can be driven by internal logic or through another external pin.

This flip-flop is asynchronously cleared, outputs Low, when power is applied. For FPGA devices, power-on conditions are simulated when global set/reset (GSR) is active. GSR defaults to active-High but can be inverted by adding an inverter in front of the GSR input of the appropriate `STARTUP_architecture` symbol.

### Logic Table

Inputs		Outputs
D	C	Q
D	↑	D

### Design Entry Method

This design element is only for use in schematics.

### For More Information

- See the [Spartan-3 User Guide](#).
- See the [Spartan-3 Data Sheets](#).

## IFDI\_1

Macro: Input D Flip-Flop with Inverted Clock (Asynchronous Preset)

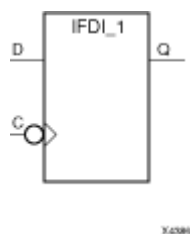

### Introduction

The design element is a D-type flip-flop is contained in an input/output block (IOB). The input (D) of the flip-flop is connected to an IPAD or an IOPAD. The (D) input provides data input for the flip-flop, which synchronizes data entering the chip. The data on input (D) is loaded into the flip-flop during the High-to-Low clock (C) transition and appears at the output (Q). The clock input can be driven by internal logic or through another external pin.

This flip-flop is asynchronously cleared, outputs Low, when power is applied. For FPGA devices, power-on conditions are simulated when global set/reset (GSR) is active. GSR defaults to active-High but can be inverted by adding an inverter in front of the GSR input of the appropriate *STARTUP\_architecture* symbol.

### Logic Table

Inputs		Outputs
D	C	Q
0	↓	D

### Design Entry Method

This design element is only for use in schematics.

### For More Information

- See the [Spartan-3 User Guide](#).
- See the [Spartan-3 Data Sheets](#).

## IFDX

Macro: Input D Flip-Flop with Clock Enable

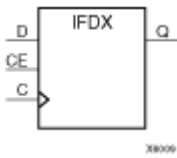

### Introduction

This D-type flip-flop is contained in an input/output block (IOB). The input (D) of the flip-flop is connected to an IPAD or an IOPAD (without using an IBUF). The D input provides data input for the flip-flop, which synchronizes data entering the chip. When CE is High, the data on input D is loaded into the flip-flop during the Low-to-High clock (C) transition and appears at the output (Q). The clock input can be driven by internal logic or through another external pin. When CE is Low, flip-flop outputs do not change.

This flip-flop is asynchronously cleared, outputs Low, when power is applied. For FPGA devices, power-on conditions are simulated when global set/reset (GSR) is active. GSR defaults to active-High but can be inverted by adding an inverter in front of the GSR input of the appropriate *STARTUP\_architecture* symbol.

### Logic Table

Inputs			Outputs
CE	Dn	C	Qn
1	Dn	↑	Dn
0	X	X	No Change

### Design Entry Method

This design element is only for use in schematics.

### For More Information

- See the [Spartan-3 User Guide](#).
- See the [Spartan-3 Data Sheets](#).

## IFDX\_1

Macro: Input D Flip-Flop with Inverted Clock and Clock Enable

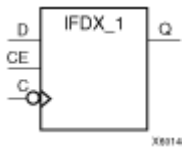

### Introduction

This design element is a D-type flip-flop is contained in an input/output block (IOB). The input (D) of the flip-flop is connected to an IPAD or an IOPAD. The D input also provides data input for the flip-flop, which synchronizes data entering the chip. When CE is High, the data on input D is loaded into the flip-flop during the High-to-Low clock (C) transition and appears at the output (Q). The clock input can be driven by internal logic or through another external pin. When the CE pin is Low, the output (Q) does not change.

This flip-flop is asynchronously cleared, outputs Low, when power is applied. For FPGA devices, power-on conditions are simulated when global set/reset (GSR) is active. GSR defaults to active-High but can be inverted by adding an inverter in front of the GSR input of the appropriate `STARTUP_architecture` symbol.

### Logic Table

Inputs			Outputs
CE	D	C	Q
1	D	↓	D
0	X	X	No Change

### Design Entry Method

This design element is only for use in schematics.

### For More Information

- See the [Spartan-3 User Guide](#).
- See the [Spartan-3 Data Sheets](#).

## IIDX16

Macro: 16-Bit Input D Flip-Flops with Clock Enable

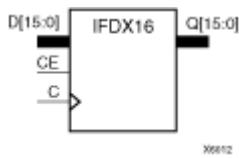

### Introduction

This D-type flip-flop is contained in an input/output block (IOB). The input (D) of the flip-flop is connected to an IPAD or an IOPAD (without using an IBUF). The D input provides data input for the flip-flop, which synchronizes data entering the chip. When CE is High, the data on input D is loaded into the flip-flop during the Low-to-High clock (C) transition and appears at the output (Q). The clock input can be driven by internal logic or through another external pin. When CE is Low, flip-flop outputs do not change.

This flip-flop is asynchronously cleared, outputs Low, when power is applied. For FPGA devices, power-on conditions are simulated when global set/reset (GSR) is active. GSR defaults to active-High but can be inverted by adding an inverter in front of the GSR input of the appropriate `STARTUP_architecture` symbol.

### Logic Table

Inputs			Outputs
CE	Dn	C	Qn
1	Dn	↑	Dn
0	X	X	No Change

### Design Entry Method

This design element is only for use in schematics.

### For More Information

- See the [Spartan-3 User Guide](#).
- See the [Spartan-3 Data Sheets](#).



## IFDX4

Macro: 4-Bit Input D Flip-Flop with Clock Enable

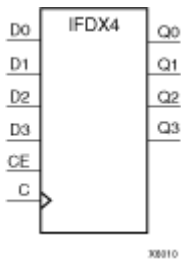

### Introduction

This D-type flip-flop is contained in an input/output block (IOB). The input (D) of the flip-flop is connected to an IPAD or an IOPAD (without using an IBUF). The D input provides data input for the flip-flop, which synchronizes data entering the chip. When CE is High, the data on input D is loaded into the flip-flop during the Low-to-High clock (C) transition and appears at the output (Q). The clock input can be driven by internal logic or through another external pin. When CE is Low, flip-flop outputs do not change.

This flip-flop is asynchronously cleared, outputs Low, when power is applied. For FPGA devices, power-on conditions are simulated when global set/reset (GSR) is active. GSR defaults to active-High but can be inverted by adding an inverter in front of the GSR input of the appropriate `STARTUP_architecture` symbol.

### Logic Table

Inputs			Outputs
CE	Dn	C	Qn
1	Dn	↑	Dn
0	X	X	No Change

### Design Entry Method

This design element is only for use in schematics.

### For More Information

- See the [Spartan-3 User Guide](#).
- See the [Spartan-3 Data Sheets](#).

## IFDX8

Macro: 8-Bit Input D Flip-Flop with Clock Enable

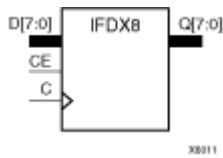

### Introduction

This D-type flip-flop is contained in an input/output block (IOB). The input (D) of the flip-flop is connected to an IPAD or an IOPAD (without using an IBUF). The D input provides data input for the flip-flop, which synchronizes data entering the chip. When CE is High, the data on input D is loaded into the flip-flop during the Low-to-High clock (C) transition and appears at the output (Q). The clock input can be driven by internal logic or through another external pin. When CE is Low, flip-flop outputs do not change.

This flip-flop is asynchronously cleared, outputs Low, when power is applied. For FPGA devices, power-on conditions are simulated when global set/reset (GSR) is active. GSR defaults to active-High but can be inverted by adding an inverter in front of the GSR input of the appropriate `STARTUP_architecture` symbol.

### Logic Table

Inputs			Outputs
CE	Dn	C	Qn
1	Dn	↑	Dn
0	X	X	No Change

### Design Entry Method

This design element is only for use in schematics.

### For More Information

- See the [Spartan-3 User Guide](#).
- See the [Spartan-3 Data Sheets](#).

## IFDXI

Macro: Input D Flip-Flop with Clock Enable (Asynchronous Preset)

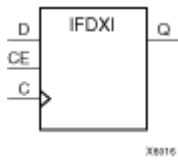

### Introduction

The design element is a D-type flip-flop is contained in an input/output block (IOB). The input (D) of the flip-flop is connected to an IPAD or an IOPAD. The D input provides data input for the flip-flop, which synchronizes data entering the chip. When CE is High, the data on input D is loaded into the flip-flop during the Low-to-High clock (C) transition and appears at the output (Q). The clock input can be driven by internal logic or through another external pin. When the CE pin is Low, the output (Q) does not change.

This flip-flop is asynchronously cleared, outputs Low, when power is applied. For FPGA devices, power-on conditions are simulated when global set/reset (GSR) is active. GSR defaults to active-High but can be inverted by adding an inverter in front of the GSR input of the appropriate *STARTUP\_architecture* symbol.

### Logic Table

Inputs			Outputs
CE	D	C	Q
1	D	↑	D
0	X	X	No Change

### Design Entry Method

This design element is only for use in schematics.

### For More Information

- See the [Spartan-3 User Guide](#).
- See the [Spartan-3 Data Sheets](#).

## IFDXI\_1

Macro: Input D Flip-Flop with Inverted Clock and Clock Enable (Asynchronous Preset)

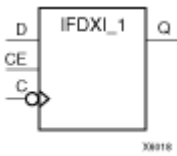

### Introduction

The design element is a D-type flip-flop that is contained in an input/output block (IOB). The input (D) of the flip-flop is connected to an IPAD or an IOPAD. The (D) input provides data input for the flip-flop, which synchronizes data entering the chip. When (CE) is High, the data on input (D) is loaded into the flip-flop during the High-to-Low clock (C) transition and appears at the output (Q). The clock input can be driven by internal logic or through another external pin. When the (CE) pin is Low, the output (Q) does not change.

This flip-flop is asynchronously cleared, outputs Low, when power is applied. For FPGA devices, power-on conditions are simulated when global set/reset (GSR) is active. GSR defaults to active-High but can be inverted by adding an inverter in front of the GSR input of the appropriate `STARTUP_architecture` symbol.

### Logic Table

Inputs			Outputs
CE	D	C	Q
1	D	↓	D
0	X	X	No Change

### Design Entry Method

This design element is only for use in schematics.

### For More Information

- See the [Spartan-3 User Guide](#).
- See the [Spartan-3 Data Sheets](#).

## ILD

Macro: Transparent Input Data Latch

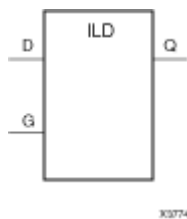

### Introduction

This design element is a single, transparent data latch that holds transient data entering a chip. This latch is contained in an input/output block (IOB). The latch input (D) is connected to an IPAD or an IOPAD (without using an IBUF). When the gate input (G) is High, data on the input (D) appears on the output (Q). Data on the D input during the High-to-Low G transition is stored in the latch.

This latch is asynchronously cleared, outputs Low, when power is applied. For FPGA devices, power-on conditions are simulated when global set/reset (GSR) is active. GSR defaults to active-High but can be inverted by adding an inverter in front of the GSR input of the appropriate *STARTUP\_architecture* symbol.

### Logic Table

Inputs		Output
G	D	Q
1	D	D
0	X	No Change
∅	D	D

### Design Entry Method

This design element is only for use in schematics.

### For More Information

- See the [Spartan-3 User Guide](#).
- See the [Spartan-3 Data Sheets](#).

## ILD\_1

Macro: Transparent Input Data Latch with Inverted Gate

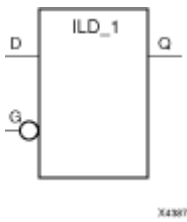

### Introduction

This design element is a transparent data latch that holds transient data entering a chip. When the gate input (G) is Low, data on the data input (D) appears on the data output (Q). Data on (D) during the Low-to-High (G) transition is stored in the latch.

This latch is asynchronously cleared, outputs Low, when power is applied. For FPGA devices, power-on conditions are simulated when global set/reset (GSR) is active. GSR defaults to active-High but can be inverted by adding an inverter in front of the GSR input of the appropriate *STARTUP\_architecture* symbol.

### Logic Table

Inputs		Outputs
G	D	Q
0	D	D
1	X	D
↑	D	D

### Design Entry Method

This component is inside the IOB. It cannot be directly inferred. The most common design practice is to infer a regular component and put an IOB=TRUE attribute on the component in the UCF file or in the code. For instance, to get an ILD\_1, you would infer an ILD\_1 and put the IOB = TRUE attribute on the component. Or, you could use the map option `-pri 0` to pack all input registers into the IOBs.

### For More Information

- See the [Spartan-3 User Guide](#).
- See the [Spartan-3 Data Sheets](#).

# ILD16

Macro: Transparent Input Data Latch

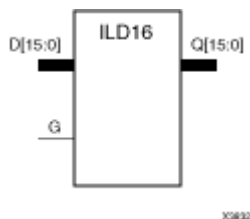

## Introduction

These design elements are multiple transparent data latches that hold transient data entering a chip. The ILD latch is contained in an input/output block (IOB). The latch input (D) is connected to an IPAD or an IOPAD (without using an IBUF). When the gate input (G) is High, data on the inputs (D) appears on the outputs (Q). Data on the D inputs during the High-to-Low G transition is stored in the latch.

This latch is asynchronously cleared, outputs Low, when power is applied. For FPGA devices, power-on conditions are simulated when global set/reset (GSR) is active. GSR defaults to active-High but can be inverted by adding an inverter in front of the GSR input of the appropriate *STARTUP\_architecture* symbol.

## Logic Table

Inputs		Outputs
G	D	Q
1	D	D
0	X	No Change
↓	D	D

## Design Entry Method

This design element is only for use in schematics.

## For More Information

- See the [Spartan-3 User Guide](#).
- See the [Spartan-3 Data Sheets](#).

## ILD4

Macro: Transparent Input Data Latch

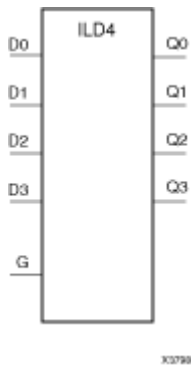

### Introduction

These design elements are multiple transparent data latches that hold transient data entering a chip. The ILD latch is contained in an input/output block (IOB). The latch input (D) is connected to an IPAD or an IOPAD (without using an IBUF). When the gate input (G) is High, data on the inputs (D) appears on the outputs (Q). Data on the D inputs during the High-to-Low G transition is stored in the latch.

This latch is asynchronously cleared, outputs Low, when power is applied. For FPGA devices, power-on conditions are simulated when global set/reset (GSR) is active. GSR defaults to active-High but can be inverted by adding an inverter in front of the GSR input of the appropriate `STARTUP_architecture` symbol.

### Logic Table

Inputs		Outputs
G	D	Q
1	D	D
0	X	No Change
↓	D	D

### Design Entry Method

This design element is only for use in schematics.

### For More Information

- See the [Spartan-3 User Guide](#).
- See the [Spartan-3 Data Sheets](#).



# ILD8

Macro: Transparent Input Data Latch

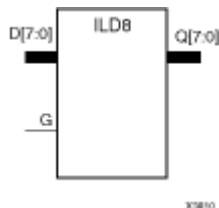

## Introduction

These design elements are multiple transparent data latches that hold transient data entering a chip. The ILD latch is contained in an input/output block (IOB). The latch input (D) is connected to an IPAD or an IOPAD (without using an IBUF). When the gate input (G) is High, data on the inputs (D) appears on the outputs (Q). Data on the D inputs during the High-to-Low G transition is stored in the latch.

This latch is asynchronously cleared, outputs Low, when power is applied. For FPGA devices, power-on conditions are simulated when global set/reset (GSR) is active. GSR defaults to active-High but can be inverted by adding an inverter in front of the GSR input of the appropriate *STARTUP\_architecture* symbol.

## Logic Table

Inputs		Outputs
G	D	Q
1	D	D
0	X	No Change
↓	D	D

## Design Entry Method

This design element is only for use in schematics.

## For More Information

- See the [Spartan-3 User Guide](#).
- See the [Spartan-3 Data Sheets](#).

## ILDI

Macro: Transparent Input Data Latch (Asynchronous Preset)

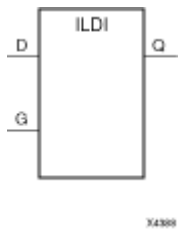

### Introduction

This design element is a transparent data latch that holds transient data entering a chip. When the gate input (G) is High, data on the input (D) appears on the output (Q). Data on the D input during the High-to-Low G transition is stored in the latch.

The ILDI is the input flip-flop master latch. It is possible to access two different outputs from the input flip-flop: one that responds to the level of the clock signal and another that responds to an edge of the clock signal. When using both outputs from the same input flip-flop, a transparent High latch (ILDI) corresponds to a falling edge-triggered flip-flop (IFDI\_1). Similarly, a transparent Low latch (ILDI\_1) corresponds to a rising edge-triggered flip-flop (IFDI).

The latch is asynchronously preset, output High, when power is applied.

For FPGA devices, power-on conditions are simulated when global set/reset (GSR) is active. GSR defaults to active-High but can be inverted by adding an inverter in front of the GSR input of the appropriate `STARTUP_architecture` symbol.

### Logic Table

Inputs		Outputs
G	D	Q
1	D	D
0	X	D
↓	D	D

### Design Entry Method

This design element is only for use in schematics.

### For More Information

- See the [Spartan-3 User Guide](#).
- See the [Spartan-3 Data Sheets](#).

## ILDI\_1

Macro: Transparent Input Data Latch with Inverted Gate (Asynchronous Preset)

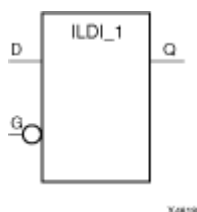

### Introduction

This design element is a transparent data latch that holds transient data entering a chip. When the gate input (G) is Low, data on the data input (D) appears on the data output (Q). Data on D during the Low-to-High G transition is stored in the latch.

The latch is asynchronously preset, output High, when power is applied.

For FPGA devices, power-on conditions are simulated when global set/reset (GSR) is active. GSR defaults to active-High but can be inverted by adding an inverter in front of the GSR input of the appropriate `STARTUP_architecture` symbol.

### Logic Table

Inputs		Outputs
G	D	Q
0	1	1
0	0	0
1	X	D
↑	D	D

### Design Entry Method

This design element is only for use in schematics.

### For More Information

- See the [Spartan-3 User Guide](#).
- See the [Spartan-3 Data Sheets](#).

# ILDX

Macro: Transparent Input Data Latch

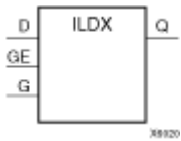

## Introduction

This design element is single or multiple transparent data latches that holds transient data entering a chip. The latch input (D) is connected to an IPAD or an IOPAD (without using an IBUF).

The ILDX is the input flip-flop master latch. Two outputs can be accessed from the input flip-flop: one that responds to the level of the clock signal and another that responds to an edge of the clock signal. When using both outputs from the same input flip-flop, a transparent High latch (ILDX) corresponds to a falling edge-triggered flip-flop (IFDX\_1). Similarly, a transparent Low latch (ILDX\_1) corresponds to a rising edge-triggered flip-flop (IFDX).

This latch is asynchronously cleared, outputs Low, when power is applied. For FPGA devices, power-on conditions are simulated when global set/reset (GSR) is active. GSR defaults to active-High but can be inverted by adding an inverter in front of the GSR input of the appropriate `STARTUP_architecture` symbol.

## Logic Table

Inputs			Outputs
GE	G	D	Q
0	X	X	No Change
1	0	X	No Change
1	1	D	D

## Design Entry Method

This design element is only for use in schematics.

## For More Information

- See the [Spartan-3 User Guide](#).
- See the [Spartan-3 Data Sheets](#).

## ILDX\_1

Macro: Transparent Input Data Latch with Inverted Gate

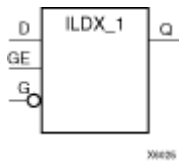

### Introduction

This design element is a transparent data latch that holds transient data entering a chip. When the gate input (G) is Low, data on the data input (D) appears on the data output (Q). Data on D during the Low-to-High G transition is stored in the latch.

This latch is asynchronously cleared, outputs Low, when power is applied. For FPGA devices, power-on conditions are simulated when global set/reset (GSR) is active. GSR defaults to active-High but can be inverted by adding an inverter in front of the GSR input of the appropriate `STARTUP_architecture` symbol.

### Logic Table

Inputs			Outputs
GE	G	D	Q
0	X	X	No Change
1	1	X	No Change
1	0	1	1
1	0	0	0
1	↑	D	D

### Design Entry Method

This design element is only for use in schematics.

### For More Information

- See the [Spartan-3 User Guide](#).
- See the [Spartan-3 Data Sheets](#).

## ILDX16

Macro: Transparent Input Data Latch

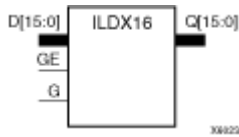

### Introduction

This design element is single or multiple transparent data latches that holds transient data entering a chip. The latch input (D) is connected to an IPAD or an IOPAD (without using an IBUF).

The ILDX is the input flip-flop master latch. Two outputs can be accessed from the input flip-flop: one that responds to the level of the clock signal and another that responds to an edge of the clock signal. When using both outputs from the same input flip-flop, a transparent High latch (ILDX) corresponds to a falling edge-triggered flip-flop (IFDX\_1). Similarly, a transparent Low latch (ILDX\_1) corresponds to a rising edge-triggered flip-flop (IFDX)

This latch is asynchronously cleared, outputs Low, when power is applied. For FPGA devices, power-on conditions are simulated when global set/reset (GSR) is active. GSR defaults to active-High but can be inverted by adding an inverter in front of the GSR input of the appropriate *STARTUP\_architecture* symbol.

### Logic Table

Inputs			Outputs
GE	G	D	Q
0	X	X	No Change
1	0	X	No Change
1	1	D	D

### Design Entry Method

This design element is only for use in schematics.

### For More Information

- See the [Spartan-3 User Guide](#).
- See the [Spartan-3 Data Sheets](#).

## ILDX4

Macro: Transparent Input Data Latch

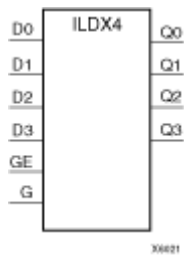

### Introduction

This design element is single or multiple transparent data latches that holds transient data entering a chip. The latch input (D) is connected to an IPAD or an IOPAD (without using an IBUF).

The ILDX is the input flip-flop master latch. Two outputs can be accessed from the input flip-flop: one that responds to the level of the clock signal and another that responds to an edge of the clock signal. When using both outputs from the same input flip-flop, a transparent High latch (ILDX) corresponds to a falling edge-triggered flip-flop (IFDX\_1). Similarly, a transparent Low latch (ILDX\_1) corresponds to a rising edge-triggered flip-flop (IFDX)

This latch is asynchronously cleared, outputs Low, when power is applied. For FPGA devices, power-on conditions are simulated when global set/reset (GSR) is active. GSR defaults to active-High but can be inverted by adding an inverter in front of the GSR input of the appropriate STARTUP\_architecture symbol.

### Logic Table

Inputs			Outputs
GE	G	D	Q
0	X	X	No Change
1	0	X	No Change
1	1	D	D

### Design Entry Method

This design element is only for use in schematics.

### For More Information

- See the [Spartan-3 User Guide](#).
- See the [Spartan-3 Data Sheets](#).

## ILDX8

Macro: Transparent Input Data Latch

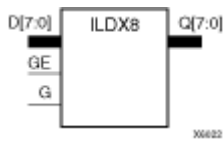

### Introduction

This design element is single or multiple transparent data latches that holds transient data entering a chip. The latch input (D) is connected to an IPAD or an IOPAD (without using an IBUF).

The ILDX is the input flip-flop master latch. Two outputs can be accessed from the input flip-flop: one that responds to the level of the clock signal and another that responds to an edge of the clock signal. When using both outputs from the same input flip-flop, a transparent High latch (ILDX) corresponds to a falling edge-triggered flip-flop (IFDX\_1). Similarly, a transparent Low latch (ILDX\_1) corresponds to a rising edge-triggered flip-flop (IFDX).

This latch is asynchronously cleared, outputs Low, when power is applied. For FPGA devices, power-on conditions are simulated when global set/reset (GSR) is active. GSR defaults to active-High but can be inverted by adding an inverter in front of the GSR input of the appropriate `STARTUP_architecture` symbol.

### Logic Table

Inputs			Outputs
GE	G	D	Q
0	X	X	No Change
1	0	X	No Change
1	1	D	D

### Design Entry Method

This design element is only for use in schematics.

### For More Information

- See the [Spartan-3 User Guide](#).
- See the [Spartan-3 Data Sheets](#).



## ILDXI

Macro: Transparent Input Data Latch (Asynchronous Preset)

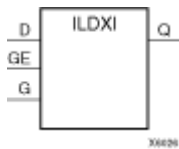

### Introduction

This design element is a transparent data latch that holds transient data entering a chip. When the gate input (G) is High, data on the input (D) appears on the output (Q). Data on the (D) input during the High-to-Low (G) transition is stored in the latch.

The ILDXI is the input flip-flop master latch. Two outputs can be accessed from the input flip-flop: one that responds to the level of the clock signal and another that responds to an edge of the clock signal. When using both outputs from the same input flip-flop, a transparent High latch (ILDXI) corresponds to a falling edge-triggered flip-flop (IFDXI\_1). Similarly, a transparent Low latch (ILDXI\_1) corresponds to a rising edge-triggered flip-flop (IFDXI).

The latch is asynchronously preset, output High, when power is applied.

For FPGA devices, power-on conditions are simulated when global set/reset (GSR) is active. GSR defaults to active-High but can be inverted by adding an inverter in front of the GSR input of the appropriate `STARTUP_architecture` symbol.

### Logic Table

Inputs			Outputs
GE	G	D	Q
0	X	X	No Change
1	0	X	No Change
1	1	D	D
1	↓	D	D

### Design Entry Method

This design element is only for use in schematics.

### For More Information

- See the [Spartan-3 User Guide](#).
- See the [Spartan-3 Data Sheets](#).

## ILDXI\_1

Macro: Transparent Input Data Latch with Inverted Gate (Asynchronous Preset)

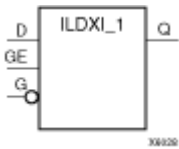

### Introduction

This design element is a transparent data latch that holds transient data entering a chip.

The latch is asynchronously preset, output High, when power is applied.

For FPGA devices, power-on conditions are simulated when global set/reset (GSR) is active. GSR defaults to active-High but can be inverted by adding an inverter in front of the GSR input of the appropriate `STARTUP_architecture` symbol.

### Logic Table

Inputs			Outputs
GE	G	D	Q
0	X	X	No Change
1	1	X	No Change
1	0	D	D
1	↑	D	D

### Design Entry Method

This design element is only for use in schematics.

### For More Information

- See the [Spartan-3 User Guide](#).
- See the [Spartan-3 Data Sheets](#).

## INV

Primitive: Inverter

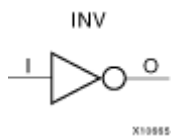

### Introduction

This design element is a single inverter that identifies signal inversions in a schematic.

### Design Entry Method

This design element is only for use in schematics.

### For More Information

- See the [Spartan-3 User Guide](#).
- See the [Spartan-3 Data Sheets](#).

## INV16

Macro: 16 Inverters

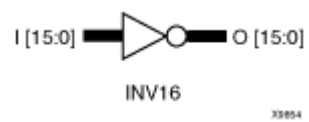

### Introduction

This design element is a multiple inverter that identifies signal inversions in a schematic.

### Design Entry Method

This design element is only for use in schematics.

### For More Information

- See the [Spartan-3 User Guide](#).
- See the [Spartan-3 Data Sheets](#).

## INV4

Macro: Four Inverters

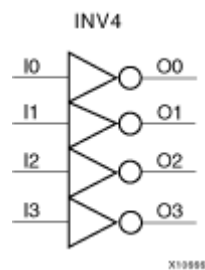

### Introduction

This design element is a multiple inverter that identifies signal inversions in a schematic.

### Design Entry Method

This design element is only for use in schematics.

### For More Information

- See the [Spartan-3 User Guide](#).
- See the [Spartan-3 Data Sheets](#).

## INV8

Macro: Eight Inverters

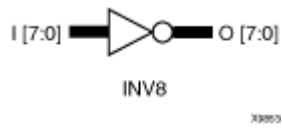

### Introduction

This design element is a multiple inverter that identifies signal inversions in a schematic.

### Design Entry Method

This design element is only for use in schematics.

### For More Information

- See the [Spartan-3 User Guide](#).
- See the [Spartan-3 Data Sheets](#).

## IOBUF

Primitive: Bi-Directional Buffer

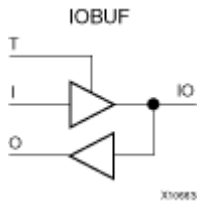

### Introduction

The design element is a bidirectional single-ended I/O Buffer used to connect internal logic to an external bidirectional pin.

### Logic Table

Inputs		Bidirectional	Outputs
T	I	IO	O
1	X	Z	X
0	1	1	1
0	0	0	0

### Port Descriptions

Name	Direction	Width	Function
O	Output	1-Bit	Buffer output
IO	Inout	1-Bit	Buffer inout
I	Input	1-Bit	Buffer input
T	Input	1-Bit	3-State enable input

### Design Entry Method

This design element can be used in schematics.

### Available Attributes

Attribute	Type	Allowed Values	Default	Descriptions
DRIVE	Integer	2, 4, 6, 8, 12, 16, 24	12	Selects output drive strength (mA) for the SelectIO buffers that use the LVTTTL, LVCMOS12, LVCMOS15, LVCMOS18, LVCMOS25, or LVCMOS33 interface I/O standard.
IOSTANDARD	String	"DEFAULT"	"DEFAULT"	Use to assign an I/O standard to an I/O primitive.
IBUF_DELAY_VALUE	Binary	0 thru 12	0	Specifies the amount of additional delay to add to the non-registered path out of the IOB

Attribute	Type	Allowed Values	Default	Descriptions
IFD_DELAY_VALUE	Binary	AUTO, 0 thru 6	AUTO	Specifies the amount of additional delay to add to the registered path within the IOB
SLEW	Integer	"SLOW", "FAST"	"SLOW"	Sets the output rise and fall time.

### For More Information

- See the [Spartan-3 User Guide](#).
- See the [Spartan-3 Data Sheets](#).



## IOBUFDS

Primitive: 3-State Differential Signaling I/O Buffer with Active Low Output Enable

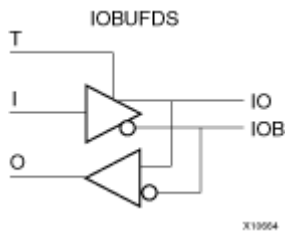

### Introduction

The design element is a bidirectional buffer that supports low-voltage, differential signaling. For the IOBUFDS, a design level interface signal is represented as two distinct ports (IO and IOB), one deemed the "master" and the other the "slave." The master and the slave are opposite phases of the same logical signal (for example, MYNET\_P and MYNET\_N). Optionally, a programmable differential termination feature is available to help improve signal integrity and reduce external components. Also available is a programmable delay to assist in the capturing of incoming data to the device.

### Logic Table

Inputs		Bidirectional		Outputs
I	T	IO	IOB	O
X	1	Z	Z	No Change
0	0	0	1	0
1	0	1	0	1

### Port Descriptions

Name	Direction	Width	Function
O	Output	1-Bit	Buffer output
IO	Inout	1-Bit	Diff_p inout
IOB	Inout	1-Bit	Diff_n inout
I	Input	1-Bit	Buffer input
T	Input	1-Bit	3-state enable input

### Design Entry Method

This design element can be used in schematics.

### Available Attributes

Attribute	Type	Allowed Values	Default	Descriptions
IFD_DELAY_VALUE	String	"AUTO" or 0 to 6	"AUTO"	Specifies the amount of additional delay to add to the registered path within the IOB.
IOSTANDARD	String	"DEFAULT"	"DEFAULT"	Use to assign an I/O standard to an I/O primitive.

## For More Information

- See the [Spartan-3 User Guide](#).
- See the [Spartan-3 Data Sheets](#).

## KEEPER

### Primitive: KEEPER Symbol



### Introduction

The design element is a weak keeper element that retains the value of the net connected to its bidirectional O pin. For example, if a logic 1 is being driven onto the net, KEEPER drives a weak/resistive 1 onto the net. If the net driver is then 3-stated, KEEPER continues to drive a weak/resistive 1 onto the net.

### Port Descriptions

Name	Direction	Width	Function
O	Output	1-Bit	Keeper output

### Design Entry Method

This design element can be used in schematics.

This element can be connected to a net in the following locations on a top-level schematic file:

- A net connected to an input IO Marker
- A net connected to both an output IO Marker and 3-statable IO element, such as an OBUFT.

### For More Information

- See the [Spartan-3 User Guide](#).
- See the [Spartan-3 Data Sheets](#).

## LD

Primitive: Transparent Data Latch

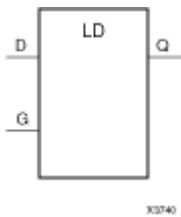

### Introduction

LD is a transparent data latch. The data output (Q) of the latch reflects the data (D) input while the gate enable (G) input is High. The data on the (D) input during the High-to-Low gate transition is stored in the latch. The data on the (Q) output remains unchanged as long as (G) remains Low.

This latch is asynchronously cleared, outputs Low, when power is applied. For FPGA devices, power-on conditions are simulated when global set/reset (GSR) is active. GSR defaults to active-High but can be inverted by adding an inverter in front of the GSR input of the appropriate *STARTUP\_architecture* symbol.

### Logic Table

Inputs		Outputs
G	D	Q
1	D	D
0	X	No Change
↓	D	D

### Design Entry Method

This design element is only for use in schematics.

### For More Information

- See the [Spartan-3 User Guide](#).
- See the [Spartan-3 Data Sheets](#).

## LD\_1

Primitive: Transparent Data Latch with Inverted Gate

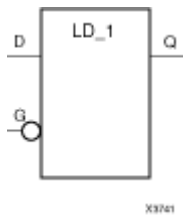

### Introduction

This design element is a transparent data latch with an inverted gate. The data output (Q) of the latch reflects the data (D) input while the gate enable (G) input is Low. The data on the (D) input during the Low-to-High gate transition is stored in the latch. The data on the (Q) output remains unchanged as long as (G) remains High.

This latch is asynchronously cleared, outputs Low, when power is applied. For FPGA devices, power-on conditions are simulated when global set/reset (GSR) is active. GSR defaults to active-High but can be inverted by adding an inverter in front of the GSR input of the appropriate *STARTUP\_architecture* symbol.

### Logic Table

Inputs		Outputs
G	D	Q
0	D	D
1	X	No Change
?	D	D

### Design Entry Method

This design element is only for use in schematics.

### Available Attributes

Attribute	Type	Allowed Values	Default	Description
INIT	1-Bit Binary	1-Bit Binary	All zeros	Sets the initial value of Q output after configuration.

### For More Information

- See the [Spartan-3 User Guide](#).
- See the [Spartan-3 Data Sheets](#).

## LD16

Macro: Multiple Transparent Data Latch

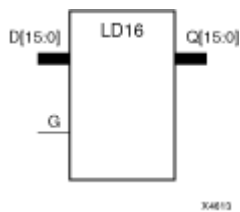

### Introduction

This design element has 16 transparent data latches with a common gate enable (G). The data output (Q) of the latch reflects the data (D) input while the gate enable (G) input is High. The data on the (D) input during the High-to-Low gate transition is stored in the latch. The data on the (Q) output remains unchanged as long as (G) remains Low.

This latch is asynchronously cleared, outputs Low, when power is applied. For FPGA devices, power-on conditions are simulated when global set/reset (GSR) is active. GSR defaults to active-High but can be inverted by adding an inverter in front of the GSR input of the appropriate `STARTUP_architecture` symbol.

### Logic Table

Inputs		Outputs
G	D	Q
1	D	D
0	X	No Change
↓	Dn	Dn

### Design Entry Method

This design element is only for use in schematics.

### Available Attributes

Attribute	Type	Allowed Values	Default	Description
INIT	Binary	Any 16-Bit Value	All zeros	Sets the initial value of Q output after configuration

### For More Information

- See the [Spartan-3 User Guide](#).
- See the [Spartan-3 Data Sheets](#).

# LD16CE

Macro: Transparent Data Latch with Asynchronous Clear and Gate Enable

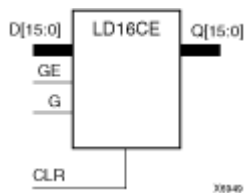

## Introduction

This design element has 16 transparent data latches with asynchronous clear and gate enable. When the asynchronous clear input (CLR) is High, it overrides the other inputs and resets the data (Q) outputs Low. (Q) reflects the data (D) inputs while the gate (G) and gate enable (GE) are High, and (CLR) is Low. If (GE) is Low, data on (D) cannot be latched. The data on the (D) input during the High-to-Low gate transition is stored in the latch. The data on the (Q) output remains unchanged as long as (G) or (GE) remains Low.

This latch is asynchronously cleared, outputs Low, when power is applied. For FPGA devices, power-on conditions are simulated when global set/reset (GSR) is active. GSR defaults to active-High but can be inverted by adding an inverter in front of the GSR input of the appropriate `STARTUP_architecture` symbol.

## Logic Table

Inputs				Outputs
CLR	GE	G	Dn	Qn
1	X	X	X	0
0	0	X	X	No Change
0	1	1	Dn	Dn
0	1	0	X	No Change
0	1	↓	Dn	Dn

Dn = referenced input, for example, D0, D1, D2  
 Qn = referenced output, for example, Q0, Q1, Q2

## Design Entry Method

This design element is only for use in schematics.

## Available Attributes

Attribute	Type	Allowed Values	Default	Description
INIT	Binary	Any 16-Bit Value	All zeros	Sets the initial value of Q output after configuration

## For More Information

- See the [Spartan-3 User Guide](#).
- See the [Spartan-3 Data Sheets](#).



## LD4

Macro: Multiple Transparent Data Latch

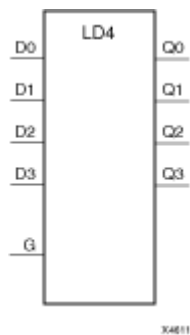

### Introduction

This design element has four transparent data latches with a common gate enable (G). The data output (Q) of the latch reflects the data (D) input while the gate enable (G) input is High. The data on the (D) input during the High-to-Low gate transition is stored in the latch. The data on the (Q) output remains unchanged as long as (G) remains Low.

This latch is asynchronously cleared, outputs Low, when power is applied. For FPGA devices, power-on conditions are simulated when global set/reset (GSR) is active. GSR defaults to active-High but can be inverted by adding an inverter in front of the GSR input of the appropriate `STARTUP_architecture` symbol.

### Logic Table

Inputs		Outputs
G	D	Q
1	D	D
0	X	No Change
↓	Dn	Dn

### Design Entry Method

This design element is only for use in schematics.

### Available Attributes

Attribute	Type	Allowed Values	Default	Description
INIT	Binary	Any 4-Bit Value	All zeros	Sets the initial value of Q output after configuration

### For More Information

- See the [Spartan-3 User Guide](#).
- See the [Spartan-3 Data Sheets](#).

## LD4CE

Macro: Transparent Data Latch with Asynchronous Clear and Gate Enable

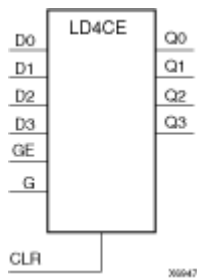

### Introduction

This design element has 4 transparent data latches with asynchronous clear and gate enable. When the asynchronous clear input (CLR) is High, it overrides the other inputs and resets the data (Q) outputs Low. (Q) reflects the data (D) inputs while the gate (G) and gate enable (GE) are High, and (CLR) is Low. If (GE) is Low, data on (D) cannot be latched. The data on the (D) input during the High-to-Low gate transition is stored in the latch. The data on the (Q) output remains unchanged as long as (G) or (GE) remains Low.

This latch is asynchronously cleared, outputs Low, when power is applied. For FPGA devices, power-on conditions are simulated when global set/reset (GSR) is active. GSR defaults to active-High but can be inverted by adding an inverter in front of the GSR input of the appropriate `STARTUP_architecture` symbol.

### Logic Table

Inputs				Outputs
CLR	GE	G	Dn	Qn
1	X	X	X	0
0	0	X	X	No Change
0	1	1	Dn	Dn
0	1	0	X	No Change
0	1	↓	Dn	Dn

Dn = referenced input, for example, D0, D1, D2  
 Qn = referenced output, for example, Q0, Q1, Q2

### Design Entry Method

This design element is only for use in schematics.

### Available Attributes

Attribute	Type	Allowed Values	Default	Description
INIT	Binary	Any 4-Bit Value	All zeros	Sets the initial value of Q output after configuration

---

## For More Information

- See the [Spartan-3 User Guide](#).
- See the [Spartan-3 Data Sheets](#).

## LD8

Macro: Multiple Transparent Data Latch

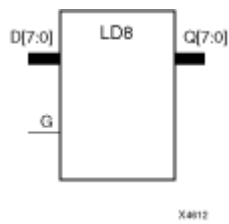

### Introduction

This design element has 8 transparent data latches with a common gate enable (G). The data output (Q) of the latch reflects the data (D) input while the gate enable (G) input is High. The data on the (D) input during the High-to-Low gate transition is stored in the latch. The data on the (Q) output remains unchanged as long as (G) remains Low.

This latch is asynchronously cleared, outputs Low, when power is applied. For FPGA devices, power-on conditions are simulated when global set/reset (GSR) is active. GSR defaults to active-High but can be inverted by adding an inverter in front of the GSR input of the appropriate *STARTUP\_architecture* symbol.

### Logic Table

Inputs		Outputs
G	D	Q
1	D	D
0	X	No Change
↓	Dn	Dn

### Design Entry Method

This design element is only for use in schematics.

### Available Attributes

Attribute	Type	Allowed Values	Default	Description
INIT	Binary	Any 8-Bit Value	All zeros	Sets the initial value of Q output after configuration

### For More Information

- See the [Spartan-3 User Guide](#).
- See the [Spartan-3 Data Sheets](#).

## LD8CE

Macro: Transparent Data Latch with Asynchronous Clear and Gate Enable

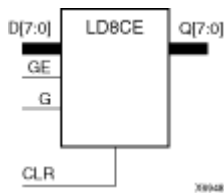

### Introduction

This design element has 8 transparent data latches with asynchronous clear and gate enable. When the asynchronous clear input (CLR) is High, it overrides the other inputs and resets the data (Q) outputs Low. (Q) reflects the data (D) inputs while the gate (G) and gate enable (GE) are High, and (CLR) is Low. If (GE) is Low, data on (D) cannot be latched. The data on the (D) input during the High-to-Low gate transition is stored in the latch. The data on the (Q) output remains unchanged as long as (G) or (GE) remains Low.

This latch is asynchronously cleared, outputs Low, when power is applied. For FPGA devices, power-on conditions are simulated when global set/reset (GSR) is active. GSR defaults to active-High but can be inverted by adding an inverter in front of the GSR input of the appropriate `STARTUP_architecture` symbol.

### Logic Table

Inputs				Outputs
CLR	GE	G	Dn	Qn
1	X	X	X	0
0	0	X	X	No Change
0	1	1	Dn	Dn
0	1	0	X	No Change
0	1	↓	Dn	Dn

Dn = referenced input, for example, D0, D1, D2  
 Qn = referenced output, for example, Q0, Q1, Q2

### Design Entry Method

This design element is only for use in schematics.

### Available Attributes

Attribute	Type	Allowed Values	Default	Description
INIT	Binary	Any 8-Bit Value	All zeros	Sets the initial value of Q output after configuration

### For More Information

- See the [Spartan-3 User Guide](#).
- See the [Spartan-3 Data Sheets](#).

## LDC

Primitive: Transparent Data Latch with Asynchronous Clear

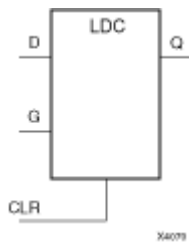

### Introduction

This design element is a transparent data latch with asynchronous clear. When the asynchronous clear input (CLR) is High, it overrides the other inputs and resets the data (Q) output Low. (Q) reflects the data (D) input while the gate enable (G) input is High and (CLR) is Low. The data on the (D) input during the High-to-Low gate transition is stored in the latch. The data on the (Q) output remains unchanged as long as (G) remains low.

This latch is asynchronously cleared, outputs Low, when power is applied. For FPGA devices, power-on conditions are simulated when global set/reset (GSR) is active. GSR defaults to active-High but can be inverted by adding an inverter in front of the GSR input of the appropriate `STARTUP_architecture` symbol.

### Logic Table

Inputs			Outputs
CLR	G	D	Q
1	X	X	0
0	1	D	D
0	0	X	No Change
0	?	D	D

### Design Entry Method

This design element is only for use in schematics.

### Available Attributes

Attribute	Type	Allowed Values	Default	Description
INIT	INTEGER	0 or 1	0	Sets the initial value of Q output after configuration.

### For More Information

- See the [Spartan-3 User Guide](#).
- See the [Spartan-3 Data Sheets](#).

## LDC\_1

Primitive: Transparent Data Latch with Asynchronous Clear and Inverted Gate

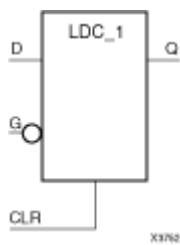

### Introduction

This design element is a transparent data latch with asynchronous clear and inverted gate. When the asynchronous clear input (CLR) is High, it overrides the other inputs (D and G) and resets the data (Q) output Low. (Q) reflects the data (D) input while the gate enable (G) input and CLR are Low. The data on the (D) input during the Low-to-High gate transition is stored in the latch. The data on the (Q) output remains unchanged as long as (G) remains High.

This latch is asynchronously cleared, outputs Low, when power is applied. For FPGA devices, power-on conditions are simulated when global set/reset (GSR) is active. GSR defaults to active-High but can be inverted by adding an inverter in front of the GSR input of the appropriate *STARTUP\_architecture* symbol.

### Logic Table

Inputs			Outputs
CLR	G	D	Q
1	X	X	0
0	0	D	D
0	1	X	No Change
0	?	D	D

### Design Entry Method

This design element is only for use in schematics.

### Available Attributes

Attribute	Type	Allowed Values	Default	Description
INIT	Integer	0 or 1	0	Sets the initial value of Q output after configuration.

### For More Information

- See the [Spartan-3 User Guide](#).
- See the [Spartan-3 Data Sheets](#).

## LDCE

Primitive: Transparent Data Latch with Asynchronous Clear and Gate Enable

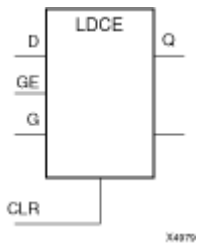

### Introduction

This design element is a transparent data latch with asynchronous clear and gate enable. When the asynchronous clear input (CLR) is High, it overrides the other inputs and resets the data (Q) output Low. Q reflects the data (D) input while the gate (G) input and gate enable (GE) are High and CLR is Low. If (GE) is Low, data on (D) cannot be latched. The data on the (D) input during the High-to-Low gate transition is stored in the latch. The data on the (Q) output remains unchanged as long as (G) or (GE) remains low.

This latch is asynchronously cleared, outputs Low, when power is applied. For FPGA devices, power-on conditions are simulated when global set/reset (GSR) is active. GSR defaults to active-High but can be inverted by adding an inverter in front of the GSR input of the appropriate `STARTUP_architecture` symbol.

### Logic Table

Inputs				Outputs
CLR	GE	G	D	Q
1	X	X	X	0
0	0	X	X	No Change
0	1	1	D	D
0	1	0	X	No Change
0	1	↓	D	D

### Design Entry Method

This design element is only for use in schematics.

### Available Attributes

Attribute	Type	Allowed Values	Default	Description
INIT	INTEGER	0 or 1	0	Sets the initial value of Q output after configuration.

### For More Information

- See the [Spartan-3 User Guide](#).
- See the [Spartan-3 Data Sheets](#).



## LDCE\_1

Primitive: Transparent Data Latch with Asynchronous Clear, Gate Enable, and Inverted Gate

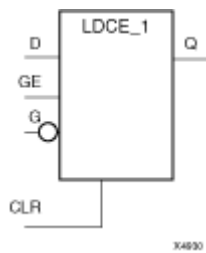

### Introduction

This design element is a transparent data latch with asynchronous clear, gate enable, and inverted gate. When the asynchronous clear input (CLR) is High, it overrides the other inputs and resets the data (Q) output Low. (Q) reflects the data (D) input while the gate (G) input and (CLR) are Low and gate enable (GE) is High. The data on the (D) input during the Low-to-High gate transition is stored in the latch. The data on the (Q) output remains unchanged as long as (G) remains High or (GE) remains Low.

This latch is asynchronously cleared, outputs Low, when power is applied. For FPGA devices, power-on conditions are simulated when global set/reset (GSR) is active. GSR defaults to active-High but can be inverted by adding an inverter in front of the GSR input of the appropriate `STARTUP_architecture` symbol.

### Logic Table

Inputs				Outputs
CLR	GE	G	D	Q
1	X	X	X	0
0	0	X	X	No Change
0	1	0	D	D
0	1	1	X	No Change
0	1	↑	D	D

### Design Entry Method

This design element is only for use in schematics.

### Available Attributes

Attribute	Type	Allowed Values	Default	Description
INIT	Integer	0 or 1	0	Sets the initial value of Q output after configuration

### For More Information

- See the [Spartan-3 User Guide](#).
- See the [Spartan-3 Data Sheets](#).

## LDCP

Primitive: Transparent Data Latch with Asynchronous Clear and Preset

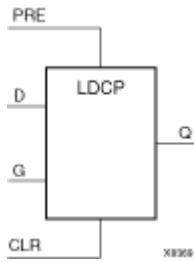

### Introduction

The design element is a transparent data latch with data (D), asynchronous clear (CLR) and preset (PRE) inputs. When (CLR) is High, it overrides the other inputs and resets the data (Q) output Low. When PRE is High and (CLR) is low, it presets the data (Q) output High. (Q) reflects the data (D) input while the gate (G) input is High and (CLR) and PRE are Low. The data on the (D) input during the High-to-Low gate transition is stored in the latch. The data on the (Q) output remains unchanged as long as (G) remains Low.

This latch is asynchronously cleared, outputs Low, when power is applied. For FPGA devices, power-on conditions are simulated when global set/reset (GSR) is active. GSR defaults to active-High but can be inverted by adding an inverter in front of the GSR input of the appropriate `STARTUP_architecture` symbol.

### Logic Table

Inputs				Outputs
CLR	PRE	G	D	Q
1	X	X	X	0
0	1	X	X	1
0	0	1	D	D
0	0	0	X	No Change
0	0	↓	D	D

### Design Entry Method

This design element is only for use in schematics.

### Available Attributes

Attribute	Type	Allowed Values	Default	Description
INIT	INTEGER	0 or 1	0	Specifies the initial value upon power-up or the assertion of GSR for the (Q) port.

### For More Information

- See the [Spartan-3 User Guide](#).
- See the [Spartan-3 Data Sheets](#).

## LDCP\_1

Primitive: Transparent Data Latch with Asynchronous Clear and Preset and Inverted Gate

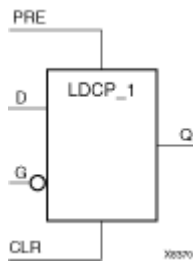

### Introduction

This design element is a transparent data latch with data (D), asynchronous clear (CLR), preset (PRE) inputs, and inverted gate (G). When (CLR) is High, it overrides the other inputs and resets the data (Q) output Low. When (PRE) is High and (CLR) is Low, it presets the data (Q) output High. (Q) reflects the data (D) input while gate (G) input, (CLR), and (PRE) are Low. The data on the (D) input during the Low-to-High gate transition is stored in the latch. The data on the (Q) output remains unchanged as long as (G) remains High.

This latch is asynchronously cleared, outputs Low, when power is applied. For FPGA devices, power-on conditions are simulated when global set/reset (GSR) is active. GSR defaults to active-High but can be inverted by adding an inverter in front of the GSR input of the appropriate `STARTUP_architecture` symbol.

### Logic Table

Inputs				Outputs
CLR	PRE	G	D	Q
1	X	X	X	0
0	1	X	X	1
0	0	0	D	D
0	0	1	X	No Change
0	0	↑	D	D

### Design Entry Method

This design element is only for use in schematics.

### Available Attributes

Attribute	Type	Allowed Values	Default	Description
INIT	Integer	0 or 1	0	Specifies the initial value upon power-up or the assertion of GSR for the (Q) port.

### For More Information

- See the [Spartan-3 User Guide](#).
- See the [Spartan-3 Data Sheets](#).

## LDCPE

Primitive: Transparent Data Latch with Asynchronous Clear and Preset and Gate Enable

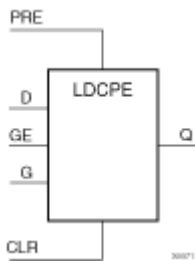

### Introduction

This design element is a transparent data latch with data (D), asynchronous clear (CLR), asynchronous preset (PRE), and gate enable (GE). When (CLR) is High, it overrides the other inputs and resets the data (Q) output Low. When (PRE) is High and (CLR) is Low, it presets the data (Q) output High. Q reflects the data (D) input while the gate (G) input and gate enable (GE) are High and (CLR) and PRE are Low. The data on the (D) input during the High-to-Low gate transition is stored in the latch. The data on the Q output remains unchanged as long as (G) or (GE) remains Low.

This latch is asynchronously cleared, outputs Low, when power is applied. For FPGA devices, power-on conditions are simulated when global set/reset (GSR) is active. GSR defaults to active-High but can be inverted by adding an inverter in front of the GSR input of the appropriate `STARTUP_architecture` symbol.

### Logic Table

Inputs					Outputs
CLR	PRE	GE	G	D	Q
1	X	X	X	X	0
0	1	X	X	X	1
0	0	0	X	X	No Change
0	0	1	1	0	0
0	0	1	1	1	1
0	0	1	0	X	No Change
0	0	1	↓	D	D

### Port Descriptions

Name	Direction	Width	Function
Q	Output	1-Bit	Data Output
CLR	Input	1-Bit	Asynchronous clear/reset input
D	Input	1-Bit	Data Input
G	Input	1-Bit	Gate Input
GE	Input	1-Bit	Gate Enable Input
PRE	Input	1-Bit	Asynchronous preset/set input

## Design Entry Method

This design element can be used in schematics.

## Available Attributes

Attribute	Type	Allowed Values	Default	Description
INIT	Integer	0 or 1	0	Sets the initial value of Q output after configuration

## For More Information

- See the [Spartan-3 User Guide](#).
- See the [Spartan-3 Data Sheets](#).

## LDCPE\_1

Primitive: Transparent Data Latch with Asynchronous Clear and Preset, Gate Enable, and Inverted Gate

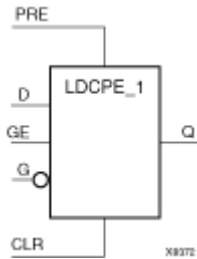

### Introduction

This design element is a transparent data latch with data (D), asynchronous clear (CLR), asynchronous preset (PRE), gate enable (GE), and inverted gate (G). When (CLR) is High, it overrides the other inputs and resets the data (Q) output Low. When PRE is High and (CLR) is Low, it presets the data (Q) output High. (Q) reflects the data (D) input while gate enable (GE) is High and gate (G), (CLR), and (PRE) are Low. The data on the (D) input during the Low-to-High gate transition is stored in the latch. The data on the (Q) output remains unchanged as long as (G) is High or (GE) is Low.

This latch is asynchronously cleared, outputs Low, when power is applied. For FPGA devices, power-on conditions are simulated when global set/reset (GSR) is active. GSR defaults to active-High but can be inverted by adding an inverter in front of the GSR input of the appropriate `STARTUP_architecture` symbol.

### Logic Table

Inputs					Outputs
CLR	PRE	GE	G	D	Q
1	X	X	X	X	0
0	1	X	X	X	1
0	0	0	X	X	No Change
0	0	1	0	D	D
0	0	1	1	X	No Change
0	0	1	↑	D	D

### Design Entry Method

This design element is only for use in schematics.

### Available Attributes

Attribute	Type	Allowed Values	Default	Description
INIT	Integer	0 or 1	0	Specifies the initial value upon power-up or the assertion of GSR for the (Q) port.

---

## For More Information

- See the [Spartan-3 User Guide](#).
- See the [Spartan-3 Data Sheets](#).

## LDE

Primitive: Transparent Data Latch with Gate Enable

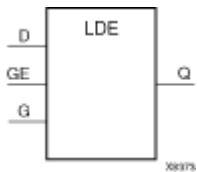

### Introduction

This design element is a transparent data latch with data (D) and gate enable (GE) inputs. Output (Q) reflects the data (D) while the gate (G) input and gate enable (GE) are High. The data on the (D) input during the High-to-Low gate transition is stored in the latch. The data on the (Q) output remains unchanged as long as (G) or (GE) remains Low.

This latch is asynchronously cleared, outputs Low, when power is applied. For FPGA devices, power-on conditions are simulated when global set/reset (GSR) is active. GSR defaults to active-High but can be inverted by adding an inverter in front of the GSR input of the appropriate `STARTUP_architecture` symbol.

### Logic Table

Inputs			Outputs
GE	G	D	Q
0	X	X	No Change
1	1	D	D
1	0	X	No Change
1	?	D	D

### Design Entry Method

This design element is only for use in schematics.

### Available Attributes

Attribute	Type	Allowed Values	Default	Description
INIT	INTEGER	0 or 1	0	Specifies the initial value upon power-up or the assertion of GSR for the (Q) port.

### For More Information

- See the [Spartan-3 User Guide](#).
- See the [Spartan-3 Data Sheets](#).



## LDE\_1

Primitive: Transparent Data Latch with Gate Enable and Inverted Gate

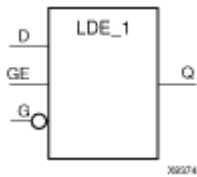

### Introduction

This design element is a transparent data latch with data (D), gate enable (GE), and inverted gate (G). Output (Q) reflects the data (D) while the gate (G) input is Low and gate enable (GE) is High. The data on the (D) input during the Low-to-High gate transition is stored in the latch. The data on the (Q) output remains unchanged as long as (G) is High or (GE) is Low.

This latch is asynchronously cleared, outputs Low, when power is applied. For FPGA devices, power-on conditions are simulated when global set/reset (GSR) is active. GSR defaults to active-High but can be inverted by adding an inverter in front of the GSR input of the appropriate `STARTUP_architecture` symbol.

### Logic Table

Inputs			Outputs
GE	G	D	Q
0	X	X	No Change
1	0	D	D
1	1	X	No Change
1	↑	D	D

### Design Entry Method

This design element is only for use in schematics.

### Available Attributes

Attribute	Type	Allowed Values	Default	Description
INIT	Integer	0 or 1	0	Specifies the initial value upon power-up or the assertion of GSR for the (Q) port.

### For More Information

- See the [Spartan-3 User Guide](#).
- See the [Spartan-3 Data Sheets](#).

## LDP

Primitive: Transparent Data Latch with Asynchronous Preset

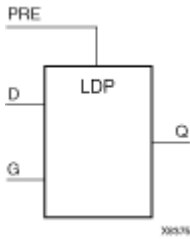

### Introduction

This design element is a transparent data latch with asynchronous preset (PRE). When the (PRE) input is High, it overrides the other inputs and presets the data (Q) output High. (Q) reflects the data (D) input while gate (G) input is High and (PRE) is Low. The data on the (D) input during the High-to-Low gate transition is stored in the latch. The data on the (Q) output remains unchanged as long as (G) remains Low.

The latch is asynchronously preset, output High, when power is applied. For FPGA devices, power-on conditions are simulated when global set/reset (GSR) is active. GSR defaults to active-High but can be inverted by adding an inverter in front of the GSR input of the appropriate `STARTUP_architecture` symbol.

### Logic Table

Inputs			Outputs
PRE	G	D	Q
1	X	X	1
0	1	0	0
0	1	1	1
0	0	X	No Change
0	↓	D	D

### Design Entry Method

This design element is only for use in schematics.

### Available Attributes

Attribute	Type	Allowed Values	Default	Description
INIT	INTEGER	0 or 1	0	Specifies the initial value upon power-up or the assertion of GSR for the (Q) port.

### For More Information

- See the [Spartan-3 User Guide](#).
- See the [Spartan-3 Data Sheets](#).

## LDP\_1

Primitive: Transparent Data Latch with Asynchronous Preset and Inverted Gate

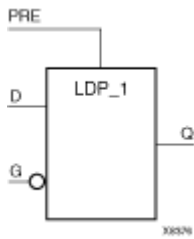

### Introduction

This design element is a transparent data latch with asynchronous preset (PRE) and inverted gate (G). When the (PRE) input is High, it overrides the other inputs and presets the data (Q) output High. (Q) reflects the data (D) input while gate (G) input and (PRE) are Low. The data on the (D) input during the Low-to-High gate transition is stored in the latch. The data on the (Q) output remains unchanged as long as (G) remains High.

The latch is asynchronously preset, output High, when power is applied. For FPGA devices, power-on conditions are simulated when global set/reset (GSR) is active. GSR defaults to active-High but can be inverted by adding an inverter in front of the GSR input of the appropriate *STARTUP\_architecture* symbol.

### Logic Table

Inputs			Outputs
PRE	G	D	Q
1	X	X	1
0	0	D	D
0	1	X	No Change
0	?	D	D

### Design Entry Method

This design element is only for use in schematics.

### Available Attributes

Attribute	Type	Allowed Values	Default	Description
INIT	Integer	0 or 1	0	Specifies the initial value upon power-up or the assertion of GSR for the (Q) port.

### For More Information

- See the [Spartan-3 User Guide](#).
- See the [Spartan-3 Data Sheets](#).

## LDPE

Primitive: Transparent Data Latch with Asynchronous Preset and Gate Enable

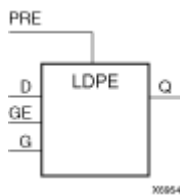

### Introduction

This design element is a transparent data latch with asynchronous preset and gate enable. When the asynchronous preset (PRE) is High, it overrides the other input and presets the data (Q) output High. Q reflects the data (D) input while the gate (G) input and gate enable (GE) are High. The data on the (D) input during the High-to-Low gate transition is stored in the latch. The data on the (Q) output remains unchanged as long as (G) or (GE) remains Low.

The latch is asynchronously preset, output High, when power is applied. For FPGA devices, power-on conditions are simulated when global set/reset (GSR) is active. GSR defaults to active-High but can be inverted by adding an inverter in front of the GSR input of the appropriate `STARTUP_architecture` symbol.

### Logic Table

Inputs				Outputs
PRE	GE	G	D	Q
1	X	X	X	1
0	0	X	X	No Change
0	1	1	D	D
0	1	0	X	No Change
0	1	↓	D	D

### Design Entry Method

This design element is only for use in schematics.

### Available Attributes

Attribute	Type	Allowed Values	Default	Description
INIT	INTEGER	0 or 1	0	Specifies the initial value upon power-up or the assertion of GSR for the (Q) port.

### For More Information

- See the [Spartan-3 User Guide](#).
- See the [Spartan-3 Data Sheets](#).

## LDPE\_1

Primitive: Transparent Data Latch with Asynchronous Preset, Gate Enable, and Inverted Gate

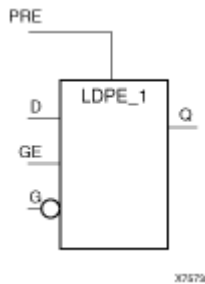

### Introduction

This design element is a transparent data latch with asynchronous preset, gate enable, and inverted gate. When the asynchronous preset (PRE) is High, it overrides the other input and presets the data (Q) output High. (Q) reflects the data (D) input while the gate (G) and (PRE) are Low and gate enable (GE) is High. The data on the (D) input during the Low-to-High gate transition is stored in the latch. The data on the (Q) output remains unchanged as long as (G) remains High or (GE) remains Low.

The latch is asynchronously preset, output High, when power is applied. For FPGA devices, power-on conditions are simulated when global set/reset (GSR) is active. GSR defaults to active-High but can be inverted by adding an inverter in front of the GSR input of the appropriate `STARTUP_architecture` symbol.

### Logic Table

Inputs				Outputs
PRE	GE	G	D	Q
1	X	X	X	1
0	0	X	X	No Change
0	1	0	D	D
0	1	1	X	No Change
0	1	↑	D	D

### Design Entry Method

This design element is only for use in schematics.

### Available Attributes

Attribute	Type	Allowed Values	Default	Description
INIT	Integer	0 or 1	0	Specifies the initial value upon power-up or the assertion of GSR for the (Q) port.

### For More Information

- See the [Spartan-3 User Guide](#).
- See the [Spartan-3 Data Sheets](#).

# LUT1

Primitive: 1-Bit Look-Up-Table with General Output

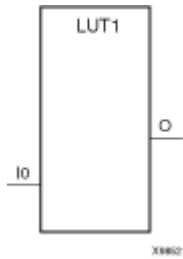

## Introduction

This design element is a 1-bit look-up-tables (LUT) with general output (O).

An INIT attribute with an appropriate number of hexadecimal digits for the number of inputs must be attached to the LUT to specify its function. This element provides a look-up-table version of a buffer or inverter. These elements are the basic building blocks. Two LUTs are available in each CLB slice; four LUTs are available in each CLB. Multiple variants of LUTs accommodate additional types of outputs that can be used by different timing models for more accurate pre-layout timing estimation.

The INIT parameter for the FPGA LUT primitive is what gives the LUT its logical value. By default, this value is zero, thus driving the output to a zero regardless of the input values (acting as a ground). However, in most cases a new INIT value must be determined in order to specify the logic function for the LUT primitive. There are at least two methods by which the LUT value can be determined:

**The Truth Table Method** -A common method to determine the desired INIT value for a LUT is using a truth table. To do so, simply create a binary truth table of all possible inputs, specify the desired logic value of the output and then create the INIT string from those output values.

**The Equation Method** -Another method to determine the LUT value is to define parameters for each input to the LUT that correspond to their listed truth value and use those to build the logic equation you are after. This method is easier to understand once you have grasped the concept and more self-documenting that the above method however does require the code to first specify the appropriate parameters.

## Logic Table

Inputs	Outputs
I0	O
0	INIT[0]
1	INIT[1]
INIT = Binary number assigned to the INIT attribute	

## Design Entry Method

This design element can be used in schematics.

## Available Attributes

Attribute	Type	Allowed Values	Default	Description
INIT	Hexadecimal	Any 2-Bit Value	All zeros	Initializes look-up tables.

---

## For More Information

- See the [Spartan-3 User Guide](#).
- See the [Spartan-3 Data Sheets](#).

## LUT1\_D

Primitive: 1-Bit Look-Up-Table with Dual Output

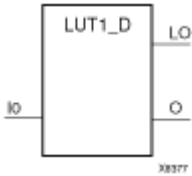

### Introduction

This design element is a 1-bit look-up-table (LUT) with two functionally identical outputs, O and LO. *LUTD\_1* provides a look-up-table version of a buffer or inverter.

The O output is a general interconnect. The LO output is used to connect to another output within the same CLB slice and to the fast connect buffer. A mandatory INIT attribute, with an appropriate number of hexadecimal digits for the number of inputs, must be attached to the LUT to specify its function.

The INIT parameter for the FPGA LUT primitive is what gives the LUT its logical value. By default, this value is zero, thus driving the output to a zero regardless of the input values (acting as a ground). However, in most cases a new INIT value must be determined in order to specify the logic function for the LUT primitive. There are at least two methods by which the LUT value can be determined:

**The Truth Table Method** -A common method to determine the desired INIT value for a LUT is using a truth table. To do so, simply create a binary truth table of all possible inputs, specify the desired logic value of the output and then create the INIT string from those output values.

**The Equation Method** -Another method to determine the LUT value is to define parameters for each input to the LUT that correspond to their listed truth value and use those to build the logic equation you are after. This method is easier to understand once you have grasped the concept and more self-documenting than the above method however does require the code to first specify the appropriate parameters.

### Logic Table

Inputs	Outputs	
I0	O	LO
0	INIT[0]	INIT[0]
1	INIT[1]	INIT[1]
INIT = Binary number assigned to the INIT attribute		

### Design Entry Method

This design element can be used in schematics.

### Available Attributes

Attribute	Type	Allowed Values	Default	Description
INIT	Hexadecimal	Any 2-Bit Value	All zeros	Initializes look-up tables.



---

## For More Information

- See the [Spartan-3 User Guide](#).
- See the [Spartan-3 Data Sheets](#).

## LUT1\_L

Primitive: 1-Bit Look-Up-Table with Local Output

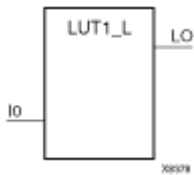

### Introduction

This design element is a 1-bit look-up-tables (LUTs) with a local output (LO) that is used to connect to another output within the same CLB slice and to the fast connect buffer. It provides a look-up-table version of a buffer or inverter.

A mandatory INIT attribute, with an appropriate number of hexadecimal digits for the number of inputs, must be attached to the LUT to specify its function.

The INIT parameter for the FPGA LUT primitive is what gives the LUT its logical value. By default, this value is zero, thus driving the output to a zero regardless of the input values (acting as a ground). However, in most cases a new INIT value must be determined in order to specify the logic function for the LUT primitive. There are at least two methods by which the LUT value can be determined:

**The Truth Table Method** -A common method to determine the desired INIT value for a LUT is using a truth table. To do so, simply create a binary truth table of all possible inputs, specify the desired logic value of the output and then create the INIT string from those output values.

**The Equation Method** -Another method to determine the LUT value is to define parameters for each input to the LUT that correspond to their listed truth value and use those to build the logic equation you are after. This method is easier to understand once you have grasped the concept and more self-documenting than the above method however does require the code to first specify the appropriate parameters.

### Logic Table

Inputs	Outputs
I0	LO
0	INIT[0]
1	INIT[1]
INIT = Binary number assigned to the INIT attribute	

### Design Entry Method

This design element can be used in schematics.

### Available Attributes

Attribute	Type	Allowed Values	Default	Description
INIT	Hexadecimal	Any 2-Bit Value	All zeros	Initializes look-up tables.

---

## For More Information

- See the [Spartan-3 User Guide](#).
- See the [Spartan-3 Data Sheets](#).

## LUT2

Primitive: 2-Bit Look-Up-Table with General Output

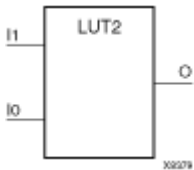

### Introduction

This design element is a 2-bit look-up-table (LUT) with general output (O).

An INIT attribute with an appropriate number of hexadecimal digits for the number of inputs must be attached to the LUT to specify its function. This element provides a look-up-table version of a buffer or inverter. These elements are the basic building blocks. Two LUTs are available in each CLB slice; four LUTs are available in each CLB. Multiple variants of LUTs accommodate additional types of outputs that can be used by different timing models for more accurate pre-layout timing estimation.

The INIT parameter for the FPGA LUT primitive is what gives the LUT its logical value. By default, this value is zero, thus driving the output to a zero regardless of the input values (acting as a ground). However, in most cases a new INIT value must be determined in order to specify the logic function for the LUT primitive. There are at least two methods by which the LUT value can be determined:

**The Truth Table Method** -A common method to determine the desired INIT value for a LUT is using a truth table. To do so, simply create a binary truth table of all possible inputs, specify the desired logic value of the output and then create the INIT string from those output values.

**The Equation Method** -Another method to determine the LUT value is to define parameters for each input to the LUT that correspond to their listed truth value and use those to build the logic equation you are after. This method is easier to understand once you have grasped the concept and more self-documenting than the above method however does require the code to first specify the appropriate parameters.

### Logic Table

Inputs		Outputs
I1	I0	O
0	0	INIT[0]
0	1	INIT[1]
1	0	INIT[2]
1	1	INIT[3]
INIT = Binary equivalent of the hexadecimal number assigned to the INIT attribute		

### Design Entry Method

This design element can be used in schematics.

### Available Attributes

Attribute	Type	Allowed Values	Default	Description
INIT	Hexadecimal	Any 4-Bit Value	All zeros	Initializes look-up tables.

---

## For More Information

- See the [Spartan-3 User Guide](#).
- See the [Spartan-3 Data Sheets](#).

## LUT2\_D

Primitive: 2-Bit Look-Up-Table with Dual Output

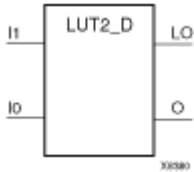

### Introduction

This design element is a 2-bit look-up-tables (LUTs) with two functionally identical outputs, O and LO.

The O output is a general interconnect. The LO output is used to connect to another output within the same CLB slice and to the fast connect buffer. A mandatory INIT attribute, with an appropriate number of hexadecimal digits for the number of inputs, must be attached to the LUT to specify its function.

The INIT parameter for the FPGA LUT primitive is what gives the LUT its logical value. By default, this value is zero, thus driving the output to a zero regardless of the input values (acting as a ground). However, in most cases a new INIT value must be determined in order to specify the logic function for the LUT primitive. There are at least two methods by which the LUT value can be determined:

**The Truth Table Method** -A common method to determine the desired INIT value for a LUT is using a truth table. To do so, simply create a binary truth table of all possible inputs, specify the desired logic value of the output and then create the INIT string from those output values.

**The Equation Method** -Another method to determine the LUT value is to define parameters for each input to the LUT that correspond to their listed truth value and use those to build the logic equation you are after. This method is easier to understand once you have grasped the concept and more self-documenting than the above method however does require the code to first specify the appropriate parameters.

### Logic Table

Inputs		Outputs	
I1	I0	O	LO
0	0	INIT[0]	INIT[0]
0	1	INIT[1]	INIT[1]
1	0	INIT[2]	INIT[2]
1	1	INIT[3]	INIT[3]

INIT = Binary equivalent of the hexadecimal number assigned to the INIT attribute

### Design Entry Method

This design element can be used in schematics.

### Available Attributes

Attribute	Type	Allowed Values	Default	Description
INIT	Hexadecimal	Any 4-Bit Value	All zeros	Initializes look-up tables.

---

## For More Information

- See the [Spartan-3 User Guide](#).
- See the [Spartan-3 Data Sheets](#).

## LUT2\_L

Primitive: 2-Bit Look-Up-Table with Local Output

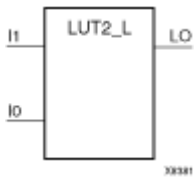

### Introduction

This design element is a 2-bit look-up-tables (LUTs) with a local output (LO) that is used to connect to another output within the same CLB slice and to the fast connect buffer. It provides a look-up-table version of a buffer or inverter.

A mandatory INIT attribute, with an appropriate number of hexadecimal digits for the number of inputs, must be attached to the LUT to specify its function.

The INIT parameter for the FPGA LUT primitive is what gives the LUT its logical value. By default, this value is zero, thus driving the output to a zero regardless of the input values (acting as a ground). However, in most cases a new INIT value must be determined in order to specify the logic function for the LUT primitive. There are at least two methods by which the LUT value can be determined:

**The Truth Table Method** -A common method to determine the desired INIT value for a LUT is using a truth table. To do so, simply create a binary truth table of all possible inputs, specify the desired logic value of the output and then create the INIT string from those output values.

**The Equation Method** -Another method to determine the LUT value is to define parameters for each input to the LUT that correspond to their listed truth value and use those to build the logic equation you are after. This method is easier to understand once you have grasped the concept and more self-documenting than the above method however does require the code to first specify the appropriate parameters.

### Logic Table

Inputs		Outputs
I1	I0	LO
0	0	INIT[0]
0	1	INIT[1]
1	0	INIT[2]
1	1	INIT[3]
INIT = Binary equivalent of the hexadecimal number assigned to the INIT attribute		

### Design Entry Method

This design element can be used in schematics.

### Available Attributes

Attribute	Type	Allowed Values	Default	Description
INIT	Hexadecimal	Any 4-Bit Value	All zeros	Initializes look-up tables.



---

## For More Information

- See the [Spartan-3 User Guide](#).
- See the [Spartan-3 Data Sheets](#).

## LUT3

Primitive: 3-Bit Look-Up-Table with General Output

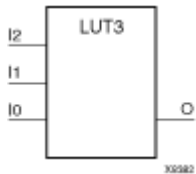

### Introduction

This design element is a 3-bit look-up-table (LUT) with general output (O). A mandatory INIT attribute, with an appropriate number of hexadecimal digits for the number of inputs, must be attached to the LUT to specify its function.

An INIT attribute with an appropriate number of hexadecimal digits for the number of inputs must be attached to the LUT to specify its function. This element provides a look-up-table version of a buffer or inverter. These elements are the basic building blocks. Two LUTs are available in each CLB slice; four LUTs are available in each CLB. Multiple variants of LUTs accommodate additional types of outputs that can be used by different timing models for more accurate pre-layout timing estimation.

### Logic Table

Inputs			Outputs
I2	I1	I0	O
0	0	0	INIT[0]
0	0	1	INIT[1]
0	1	0	INIT[2]
0	1	1	INIT[3]
1	0	0	INIT[4]
1	0	1	INIT[5]
1	1	0	INIT[6]
1	1	1	INIT[7]

INIT = Binary equivalent of the hexadecimal number assigned to the INIT attribute

### Design Entry Method

This design element can be used in schematics.

### Available Attributes

Attribute	Type	Allowed Values	Default	Description
INIT	Hexadecimal	Any 8-Bit Value	All zeros	Initializes look-up tables.

### For More Information

- See the [Spartan-3 User Guide](#).
- See the [Spartan-3 Data Sheets](#).

## LUT3\_D

Primitive: 3-Bit Look-Up-Table with Dual Output

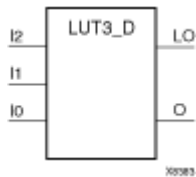

### Introduction

This design element is a 3-bit look-up-tables (LUTs) with two functionally identical outputs, O and LO.

The O output is a general interconnect. The LO output is used to connect to another output within the same CLB slice and to the fast connect buffer. A mandatory INIT attribute, with an appropriate number of hexadecimal digits for the number of inputs, must be attached to the LUT to specify its function.

The INIT parameter for the FPGA LUT primitive is what gives the LUT its logical value. By default, this value is zero, thus driving the output to a zero regardless of the input values (acting as a ground). However, in most cases a new INIT value must be determined in order to specify the logic function for the LUT primitive. There are at least two methods by which the LUT value can be determined:

**The Logic Table Method** -A common method to determine the desired INIT value for a LUT is using a truth table. To do so, simply create a binary logic table of all possible inputs, specify the desired logic value of the output and then create the INIT string from those output values.

**The Equation Method** -Another method to determine the LUT value is to define parameters for each input to the LUT that correspond to their listed truth value and use those to build the logic equation you are after. This method is easier to understand once you have grasped the concept and more self-documenting than the above method however does require the code to first specify the appropriate parameters.

### Logic Table

Inputs			Outputs	
I2	I1	I0	O	LO
0	0	0	INIT[0]	INIT[0]
0	0	1	INIT[1]	INIT[1]
0	1	0	INIT[2]	INIT[2]
0	1	1	INIT[3]	INIT[3]
1	0	0	INIT[4]	INIT[4]
1	0	1	INIT[5]	INIT[5]
1	1	0	INIT[6]	INIT[6]
1	1	1	INIT[7]	INIT[7]

INIT = Binary equivalent of the hexadecimal number assigned to the INIT attribute

### Design Entry Method

This design element can be used in schematics.

## Available Attributes

Attribute	Type	Allowed Values	Default	Description
INIT	Hexadecimal	Any 8-Bit Value	All zeros	Initializes look-up tables.

## For More Information

- See the [Spartan-3 User Guide](#).
- See the [Spartan-3 Data Sheets](#).

## LUT3\_L

Primitive: 3-Bit Look-Up-Table with Local Output

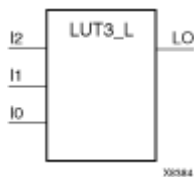

### Introduction

This design element is a 3-bit look-up-tables (LUTs) with a local output (LO) that is used to connect to another output within the same CLB slice and to the fast connect buffer. It provides a look-up-table version of a buffer or inverter.

A mandatory INIT attribute, with an appropriate number of hexadecimal digits for the number of inputs, must be attached to the LUT to specify its function.

The INIT parameter for the FPGA LUT primitive is what gives the LUT its logical value. By default, this value is zero, thus driving the output to a zero regardless of the input values (acting as a ground). However, in most cases a new INIT value must be determined in order to specify the logic function for the LUT primitive. There are at least two methods by which the LUT value can be determined:

**The Truth Table Method** -A common method to determine the desired INIT value for a LUT is using a truth table. To do so, simply create a binary truth table of all possible inputs, specify the desired logic value of the output and then create the INIT string from those output values.

**The Equation Method** -Another method to determine the LUT value is to define parameters for each input to the LUT that correspond to their listed truth value and use those to build the logic equation you are after. This method is easier to understand once you have grasped the concept and more self-documenting than the above method however does require the code to first specify the appropriate parameters.

### Logic Table

Inputs			Outputs
I2	I1	I0	LO
0	0	0	INIT[0]
0	0	1	INIT[1]
0	1	0	INIT[2]
0	1	1	INIT[3]
1	0	0	INIT[4]
1	0	1	INIT[5]
1	1	0	INIT[6]
1	1	1	INIT[7]

INIT = Binary equivalent of the hexadecimal number assigned to the INIT attribute

### Design Entry Method

This design element can be used in schematics.

## Available Attributes

Attribute	Type	Allowed Values	Default	Description
INIT	Hexadecimal	Any 8-Bit Value	All zeros	Initializes look-up tables.

## For More Information

- See the [Spartan-3 User Guide](#).
- See the [Spartan-3 Data Sheets](#).

## LUT4

Primitive: 4-Bit Look-Up-Table with General Output

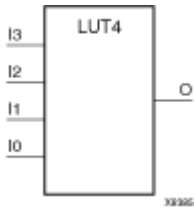

### Introduction

This design element is a 4-bit look-up-tables (LUT) with general output (O).

An INIT attribute with an appropriate number of hexadecimal digits for the number of inputs must be attached to the LUT to specify its function. This element provides a look-up-table version of a buffer or inverter. These elements are the basic building blocks. Two LUTs are available in each CLB slice; four LUTs are available in each CLB. Multiple variants of LUTs accommodate additional types of outputs that can be used by different timing models for more accurate pre-layout timing estimation.

The INIT parameter for the FPGA LUT primitive is what gives the LUT its logical value. By default, this value is zero, thus driving the output to a zero regardless of the input values (acting as a ground). However, in most cases a new INIT value must be determined in order to specify the logic function for the LUT primitive. There are at least two methods by which the LUT value can be determined:

**The Truth Table Method** -A common method to determine the desired INIT value for a LUT is using a truth table. To do so, simply create a binary truth table of all possible inputs, specify the desired logic value of the output and then create the INIT string from those output values.

**The Equation Method** -Another method to determine the LUT value is to define parameters for each input to the LUT that correspond to their listed truth value and use those to build the logic equation you are after. This method is easier to understand once you have grasped the concept and more self-documenting that the above method however does require the code to first specify the appropriate parameters.

### Logic Table

Inputs				Outputs
I3	I2	I1	I0	O
0	0	0	0	INIT[0]
0	0	0	1	INIT[1]
0	0	1	0	INIT[2]
0	0	1	1	INIT[3]
0	1	0	0	INIT[4]
0	1	0	1	INIT[5]
0	1	1	0	INIT[6]
0	1	1	1	INIT[7]
1	0	0	0	INIT[8]
1	0	0	1	INIT[9]
1	0	1	0	INIT[10]
1	0	1	1	INIT[11]
1	1	0	0	INIT[12]

Inputs				Outputs
I3	I2	I1	I0	O
1	1	0	1	INIT[13]
1	1	1	0	INIT[14]
1	1	1	1	INIT[15]

INIT = Binary equivalent of the hexadecimal number assigned to the INIT attribute

## Design Entry Method

This design element can be used in schematics.

## Available Attributes

Attribute	Type	Allowed Values	Default	Description
INIT	Hexadecimal	Any 16-Bit Value	All zeros	Initializes look-up tables.

## For More Information

- See the [Spartan-3 User Guide](#).
- See the [Spartan-3 Data Sheets](#).



## LUT4\_D

Primitive: 4-Bit Look-Up-Table with Dual Output

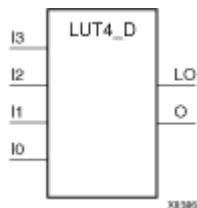

### Introduction

This design element is a 4-bit look-up-tables (LUTs) with two functionally identical outputs, O and LO

The O output is a general interconnect. The LO output is used to connect to another output within the same CLB slice and to the fast connect buffer. A mandatory INIT attribute, with an appropriate number of hexadecimal digits for the number of inputs, must be attached to the LUT to specify its function.

The INIT parameter for the FPGA LUT primitive is what gives the LUT its logical value. By default, this value is zero, thus driving the output to a zero regardless of the input values (acting as a ground). However, in most cases a new INIT value must be determined in order to specify the logic function for the LUT primitive. There are at least two methods by which the LUT value can be determined:

**The Truth Table Method** -A common method to determine the desired INIT value for a LUT is using a truth table. To do so, simply create a binary truth table of all possible inputs, specify the desired logic value of the output and then create the INIT string from those output values.

**The Equation Method** -Another method to determine the LUT value is to define parameters for each input to the LUT that correspond to their listed truth value and use those to build the logic equation you are after. This method is easier to understand once you have grasped the concept and more self-documenting than the above method however does require the code to first specify the appropriate parameters.

### Logic Table

Inputs				Outputs	
I3	I2	I1	I0	O	LO
0	0	0	0	INIT[0]	INIT[0]
0	0	0	1	INIT[1]	INIT[1]
0	0	1	0	INIT[2]	INIT[2]
0	0	1	1	INIT[3]	INIT[3]
0	1	0	0	INIT[4]	INIT[4]
0	1	0	1	INIT[5]	INIT[5]
0	1	1	0	INIT[6]	INIT[6]
0	1	1	1	INIT[7]	INIT[7]
1	0	0	0	INIT[8]	INIT[8]
1	0	0	1	INIT[9]	INIT[9]
1	0	1	0	INIT[10]	INIT[10]
1	0	1	1	INIT[11]	INIT[11]
1	1	0	0	INIT[12]	INIT[12]
1	1	0	1	INIT[13]	INIT[13]

Inputs				Outputs	
I3	I2	I1	I0	O	LO
1	1	1	0	INIT14]	INIT14]
1	1	1	1	INIT[15]	INIT[15]

INIT = Binary equivalent of the hexadecimal number assigned to the INIT attribute

## Design Entry Method

This design element can be used in schematics.

## Available Attributes

Attribute	Type	Allowed Values	Default	Description
INIT	Hexadecimal	Any 16-Bit Value	All zeros	Initializes look-up tables.

## For More Information

- See the [Spartan-3 User Guide](#).
- See the [Spartan-3 Data Sheets](#).

## LUT4\_L

Primitive: 4-Bit Look-Up-Table with Local Output

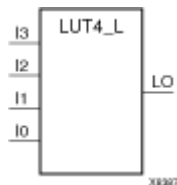

### Introduction

This design element is a 4-bit look-up-tables (LUTs) with a local output (LO) that is used to connect to another output within the same CLB slice and to the fast connect buffer. It provides a look-up-table version of a buffer or inverter.

A mandatory INIT attribute, with an appropriate number of hexadecimal digits for the number of inputs, must be attached to the LUT to specify its function.

The INIT parameter for the FPGA LUT primitive is what gives the LUT its logical value. By default, this value is zero, thus driving the output to a zero regardless of the input values (acting as a ground). However, in most cases a new INIT value must be determined in order to specify the logic function for the LUT primitive. There are at least two methods by which the LUT value can be determined:

**The Truth Table Method** -A common method to determine the desired INIT value for a LUT is using a truth table. To do so, simply create a binary truth table of all possible inputs, specify the desired logic value of the output and then create the INIT string from those output values.

**The Equation Method** -Another method to determine the LUT value is to define parameters for each input to the LUT that correspond to their listed truth value and use those to build the logic equation you are after. This method is easier to understand once you have grasped the concept and more self-documenting than the above method however does require the code to first specify the appropriate parameters.

### Logic Table

Inputs				Outputs
I3	I2	I1	I0	LO
0	0	0	0	INIT[0]
0	0	0	1	INIT[1]
0	0	1	0	INIT[2]
0	0	1	1	INIT[3]
0	1	0	0	INIT[4]
0	1	0	1	INIT[5]
0	1	1	0	INIT[6]
0	1	1	1	INIT[7]
1	0	0	0	INIT[8]
1	0	0	1	INIT[9]
1	0	1	0	INIT[10]
1	0	1	1	INIT[11]
1	1	0	0	INIT[12]
1	1	0	1	INIT[13]

Inputs				Outputs
I3	I2	I1	I0	LO
1	1	1	0	INIT[14]
1	1	1	1	INIT[15]

INIT = Binary equivalent of the hexadecimal number assigned to the INIT attribute

## Design Entry Method

This design element can be used in schematics.

## Available Attributes

Attribute	Type	Allowed Values	Default	Description
INIT	Hexadecimal	Any 16-Bit Value	All zeros	Initializes look-up tables.

## For More Information

- See the [Spartan-3 User Guide](#).
- See the [Spartan-3 Data Sheets](#).

## M16\_1E

Macro: 16-to-1 Multiplexer with Enable

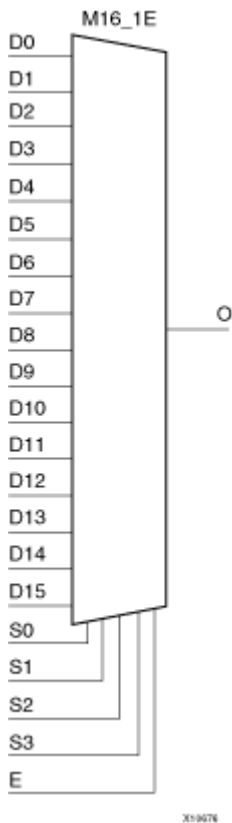

### Introduction

This design element is a 16-to-1 multiplexer with enable. When the enable input (E) is High, the M16\_1E multiplexer chooses one data bit from 16 sources (D15 – D0) under the control of the select inputs (S3 – S0). The output (O) reflects the state of the selected input as shown in the logic table. When (E) is Low, the output is Low.

### Logic Table

Inputs						Outputs
E	S3	S2	S1	S0	D15-D0	O
0	X	X	X	X	X	0
1	0	0	0	0	D0	D0
1	0	0	0	1	D1	D1
1	0	0	1	0	D2	D2
1	0	0	1	1	D3	D3
.	.	.	.	.	.	.
.	.	.	.	.	.	.
.	.	.	.	.	.	.
1	1	1	0	0	D12	D12
1	1	1	0	1	D13	D13

---

Inputs						Outputs
E	S3	S2	S1	S0	D15-D0	O
1	1	1	1	0	D14	D14
1	1	1	1	1	D15	D15

## Design Entry Method

This design element is only for use in schematics.

## For More Information

- See the [Spartan-3 User Guide](#).
- See the [Spartan-3 Data Sheets](#).

## M2\_1

Macro: 2-to-1 Multiplexer

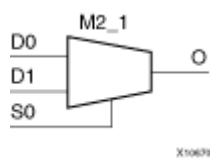

### Introduction

This design element chooses one data bit from two sources (D1 or D0) under the control of the select input (S0). The output (O) reflects the state of the selected data input. When Low, S0 selects D0 and when High, S0 selects D1.

### Logic Table

Inputs			Outputs
S0	D1	D0	O
1	D1	X	D1
0	X	D0	D0

### Design Entry Method

This design element is only for use in schematics.

### For More Information

- See the [Spartan-3 User Guide](#).
- See the [Spartan-3 Data Sheets](#).

## M2\_1B1

Macro: 2-to-1 Multiplexer with D0 Inverted

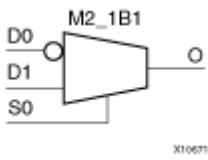

### Introduction

This design element chooses one data bit from two sources (D1 or D0) under the control of select input (S0). When S0 is Low, the output (O) reflects the inverted value of (D0). When S0 is High, (O) reflects the state of D1.

### Logic Table

Inputs			Outputs
S0	D1	D0	O
1	1	X	1
1	0	X	0
0	X	1	0
0	X	0	1

### Design Entry Method

This design element is only for use in schematics.

### For More Information

- See the [Spartan-3 User Guide](#).
- See the [Spartan-3 Data Sheets](#).



## M2\_1B2

Macro: 2-to-1 Multiplexer with D0 and D1 Inverted

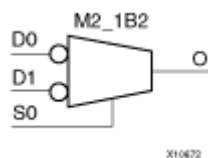

### Introduction

This design element chooses one data bit from two sources (D1 or D0) under the control of select input (S0). When S0 is Low, the output (O) reflects the inverted value of D0. When S0 is High, O reflects the inverted value of D1.

### Logic Table

Inputs			Outputs
S0	D1	D0	O
1	1	X	0
1	0	X	1
0	X	1	0
0	X	0	1

### Design Entry Method

This design element is only for use in schematics.

### For More Information

- See the [Spartan-3 User Guide](#).
- See the [Spartan-3 Data Sheets](#).

## M2\_1E

Macro: 2-to-1 Multiplexer with Enable

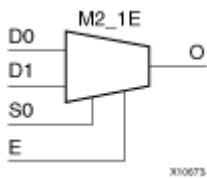

### Introduction

This design element is a 2-to-1 multiplexer with enable. When the enable input (E) is High, the M2\_1E chooses one data bit from two sources (D1 or D0) under the control of select input (S0). When Low, S0 selects D0 and when High, S0 selects D1. When (E) is Low, the output is Low.

### Logic Table

Inputs				Outputs
E	S0	D1	D0	O
0	X	X	X	0
1	0	X	1	1
1	0	X	0	0
1	1	1	X	1
1	1	0	X	0

### Design Entry Method

This design element is only for use in schematics.

### For More Information

- See the [Spartan-3 User Guide](#).
- See the [Spartan-3 Data Sheets](#).

## M4\_1E

Macro: 4-to-1 Multiplexer with Enable

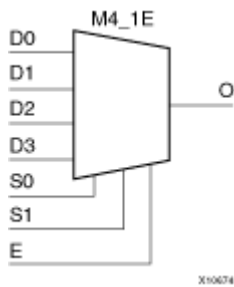

### Introduction

This design element is a 4-to-1 multiplexer with enable. When the enable input (E) is High, the M4\_1E multiplexer chooses one data bit from four sources (D3, D2, D1, or D0) under the control of the select inputs (S1 – S0). The output (O) reflects the state of the selected input as shown in the logic table. When (E) is Low, the output is Low.

### Logic Table

Inputs							Outputs
E	S1	S0	D0	D1	D2	D3	O
0	X	X	X	X	X	X	0
1	0	0	D0	X	X	X	D0
1	0	1	X	D1	X	X	D1
1	1	0	X	X	D2	X	D2
1	1	1	X	X	X	D3	D3

### Design Entry Method

This design element is only for use in schematics.

### For More Information

- See the [Spartan-3 User Guide](#).
- See the [Spartan-3 Data Sheets](#).

## M8\_1E

Macro: 8-to-1 Multiplexer with Enable

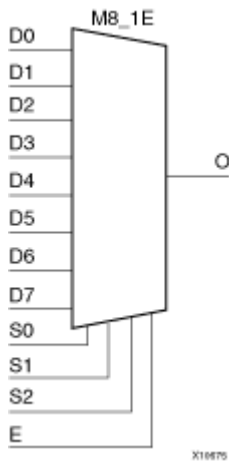

### Introduction

This design element is an 8-to-1 multiplexer with enable. When the enable input (E) is High, the M8\_1E multiplexer chooses one data bit from eight sources (D7 – D0) under the control of the select inputs (S2 – S0). The output (O) reflects the state of the selected input as shown in the logic table. When (E) is Low, the output is Low.

### Logic Table

Inputs					Outputs
E	S2	S1	S0	D7-D0	O
0	X	X	X	X	0
1	0	0	0	D0	D0
1	0	0	1	D1	D1
1	0	1	0	D2	D2
1	0	1	1	D3	D3
1	1	0	0	D4	D4
1	1	0	1	D5	D5
1	1	1	0	D6	D6
1	1	1	1	D7	D7

### Design Entry Method

This design element is only for use in schematics.

### For More Information

- See the [Spartan-3 User Guide](#).
- See the [Spartan-3 Data Sheets](#).

## MULT\_AND

Primitive: Fast Multiplier AND

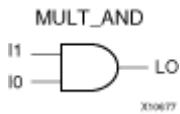

### Introduction

The design element is an AND component located within the slice where the two inputs are shared with the 4-input LUT and the output drives into the carry logic. This added logic is especially useful for building fast and smaller multipliers however be used for other purposes as well. The I1 and I0 inputs must be connected to the I1 and I0 inputs of the associated LUT. The LO output must be connected to the DI input of the associated MUXCY, MUXCY\_D, or MUXCY\_L.

### Logic Table

Inputs		Outputs
I1	I0	LO
0	0	0
0	1	0
1	0	0
1	1	1

### Design Entry Method

This design element can be used in schematics.

### For More Information

- See the [Spartan-3 User Guide](#).
- See the [Spartan-3 Data Sheets](#).

## MULT18X18

Primitive: 18 x 18 Signed Multiplier



### Introduction

MULT18X18 is a combinational signed 18-bit by 18-bit multiplier. The value represented in the 18-bit input A is multiplied by the value represented in the 18-bit input B. Output P is the 36-bit product of A and B.

### Logic Table

Inputs		Output
A	B	P
A	B	$A \times B$
A, B, and P are two's complement.		

### Design Entry Method

This design element can be used in schematics.

### For More Information

- See the [Spartan-3 User Guide](#).
- See the [Spartan-3 Data Sheets](#).

# MULT18X18S

Primitive: 18 x 18 Signed Multiplier – Registered Version

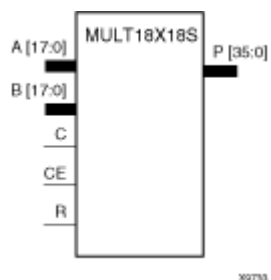

## Introduction

MULT18X18S is the registered version of the 18 x 18 signed multiplier with output P and inputs A, B, C, CE, and R. The registers are initialized to 0 after the GSR pulse.

The value represented in the 18-bit input A is multiplied by the value represented in the 18-bit input B. Output P is the 36-bit product of A and B.

## Logic Table

Inputs					Output
C	CE	Am	Bn	R	P
↑	X	X	X	1	0
↑	1	Am	Bn	0	A x B
X	0	X	X	0	No Change

A, B, and P are two's complement.

## Design Entry Method

This design element can be used in schematics.

## For More Information

- See the [Spartan-3 User Guide](#).
- See the [Spartan-3 Data Sheets](#).

## MUXCY

Primitive: 2-to-1 Multiplexer for Carry Logic with General Output

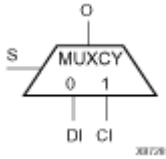

### Introduction

This design element is used to implement a 4-bit high-speed carry propagate function. One such function can be implemented per slice, for a total of 4 bits per configurable logic block (CLB) for Spartan-3A.

The direct input (DI) of a slice is connected to the (DI) input of the MUXCY. The carry in (CI) input of an LC is connected to the CI input of the MUXCY. The select input (S) of the MUXCY is driven by the output of the Look-Up Table (LUT) and configured as a MUX function. The carry out (O) of the MUXCY reflects the state of the selected input and implements the carry out function of each LC. When Low, S selects DI; when High, S selects CI.

The variants “MUXCY\_D” and “MUXCY\_L” provide additional types of outputs that can be used by different timing models for more accurate pre-layout timing estimation.

### Logic Table

Inputs			Outputs
S	DI	CI	O
0	1	X	1
0	0	X	0
1	X	1	1
1	X	0	0

### Design Entry Method

This design element can be used in schematics.

### For More Information

- See the [Spartan-3 User Guide](#).
- See the [Spartan-3 Data Sheets](#).



## MUXCY\_D

Primitive: 2-to-1 Multiplexer for Carry Logic with Dual Output

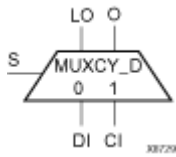

### Introduction

This design element implements a 1-bit, high-speed carry propagate function. One such function can be implemented per logic cell (LC), for a total of 4-bits per configurable logic block (CLB). The direct input (DI) of an LC is connected to the DI input of the MUXCY\_D. The carry in (CI) input of an LC is connected to the CI input of the MUXCY\_D. The select input (S) of the MUX is driven by the output of the Look-Up Table (LUT) and configured as an XOR function. The carry out (O and LO) of the MUXCY\_D reflects the state of the selected input and implements the carry out function of each LC. When Low, S selects  $\overline{DI}$ ; when High, S selects CI.

Outputs O and LO are functionally identical. The O output is a general interconnect. See also "MUXCY" and "MUXCY\_L".

### Logic Table

Inputs			Outputs	
S	DI	CI	O	LO
0	1	X	1	1
0	0	X	0	0
1	X	1	1	1
1	X	0	0	0

### Design Entry Method

This design element can be used in schematics.

### For More Information

- See the [Spartan-3 User Guide](#).
- See the [Spartan-3 Data Sheets](#).

## MUXCY\_L

Primitive: 2-to-1 Multiplexer for Carry Logic with Local Output

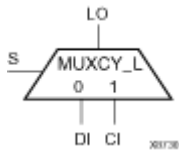

### Introduction

This design element implements a 1-bit high-speed carry propagate function. One such function is implemented per logic cell (LC), for a total of 4-bits per configurable logic block (CLB). The direct input (DI) of an LC is connected to the DI input of the MUXCY\_L. The carry in (CI) input of an LC is connected to the CI input of the MUXCY\_L. The select input (S) of the MUXCY\_L is driven by the output of the Look-Up Table (LUT) and configured as an XOR function. The carry out (LO) of the MUXCY\_L reflects the state of the selected input and implements the carry out function of each (LC). When Low, (S) selects DI; when High, (S) selects (CI).

See also "MUXCY" and "MUXCY\_D."

### Logic Table

Inputs			Outputs
S	DI	CI	LO
0	1	X	1
0	0	X	0
1	X	1	1
1	X	0	0

### Design Entry Method

This design element can be used in schematics.

### For More Information

- See the [Spartan-3 User Guide](#).
- See the [Spartan-3 Data Sheets](#).

## MUXF5

Primitive: 2-to-1 Look-Up Table Multiplexer with General Output

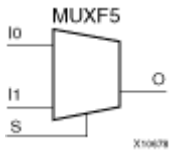

### Introduction

This design element provides a multiplexer function in a CLB slice for creating a function-of-5 lookup table or a 4-to-1 multiplexer in combination with the associated lookup tables. The local outputs (LO) from the two lookup tables are connected to the I0 and I1 inputs of the MUXF5. The (S) input is driven from any internal net. When Low, (S) selects I0. When High, (S) selects I1.

The variants, "MUXF5\_D" and "MUXF5\_L", provide additional types of outputs that can be used by different timing models for more accurate pre-layout timing estimation.

### Logic Table

Inputs			Outputs
S	I0	I1	O
0	1	X	1
0	0	X	0
1	X	1	1
1	X	0	0

### Design Entry Method

This design element can be used in schematics.

### For More Information

- See the [Spartan-3 User Guide](#).
- See the [Spartan-3 Data Sheets](#).

## MUXF5\_D

Primitive: 2-to-1 Look-Up Table Multiplexer with Dual Output

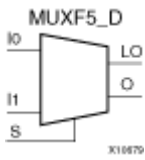

### Introduction

This design element provides a multiplexer function in a CLB slice for creating a function-of-5 lookup table or a 4-to-1 multiplexer in combination with the associated lookup tables. The local outputs (LO) from the two lookup tables are connected to the I0 and I1 inputs of the MUXF5. The S input is driven from any internal net. When Low, S selects I0. When High, S selects I1.

Outputs O and LO are functionally identical. The O output is a general interconnect. The LO output connects to other inputs in the same CLB slice. See also “MUXF5” and “MUXF5\_L”

### Logic Table

Inputs			Outputs	
S	I0	I1	O	LO
0	1	X	1	1
0	0	X	0	0
1	X	1	1	1
1	X	0	0	0

### Design Entry Method

This design element can be used in schematics.

### For More Information

- See the [Spartan-3 User Guide](#).
- See the [Spartan-3 Data Sheets](#).

## MUXF5\_L

Primitive: 2-to-1 Look-Up Table Multiplexer with Local Output

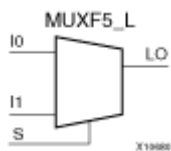

### Introduction

This design element provides a multiplexer function in a CLB slice for creating a function-of-5 lookup table or a 4-to-1 multiplexer in combination with the associated lookup tables. The local outputs (LO) from the two lookup tables are connected to the I0 and I1 inputs of the MUXF5. The S input is driven from any internal net. When Low, S selects I0. When High, S selects I1.

The LO output connects to other inputs in the same CLB slice.

See also “MUXF5” and “MUXF5\_D”

### Logic Table

Inputs			Output
S	I0	I1	LO
0	1	X	1
0	0	X	0
1	X	1	1
1	X	0	0

### Design Entry Method

This design element can be used in schematics.

### For More Information

- See the [Spartan-3 User Guide](#).
- See the [Spartan-3 Data Sheets](#).

## MUXF6

Primitive: 2-to-1 Look-Up Table Multiplexer with General Output

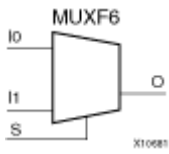

### Introduction

This design element provides a multiplexer function in two slices for creating a function-of-6 lookup table or an 8-to-1 multiplexer in combination with the associated four lookup tables and two MUXF5s. The local outputs (LO) from the two MUXF5s in the CLB are connected to the I0 and I1 inputs of the MUXF6. The S input is driven from any internal net. When Low, (S) selects I0. When High, (S) selects I1.

The variants, "MUXF6\_D" and "MUXF6\_L", provide additional types of outputs that can be used by different timing models for more accurate pre-layout timing estimation.

### Logic Table

Inputs			Outputs
S	I0	I1	O
0	1	X	1
0	0	X	0
1	X	1	1
1	X	0	0

### Design Entry Method

This design element can be used in schematics.

### For More Information

- See the [Spartan-3 User Guide](#).
- See the [Spartan-3 Data Sheets](#).

## MUXF6\_D

Primitive: 2-to-1 Look-Up Table Multiplexer with Dual Output

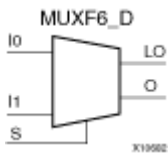

### Introduction

This design element provides a multiplexer function in a two slices for creating a function-of-6 lookup table or an 8-to-1 multiplexer in combination with the associated four lookup tables and two MUXF5s. The local outputs (LO) from the two MUXF5s in the CLB are connected to the I0 and I1 inputs of the MUXF6. The (S) input is driven from any internal net. When Low, (S) selects I0. When High, (S) selects I1.

Outputs (O) and (LO) are functionally identical. The (O) output is a general interconnect. The (LO) output connects to other inputs in the same CLB slice.

### Logic Table

Inputs			Outputs	
S	I0	I1	O	LO
0	1	X	1	1
0	0	X	0	0
1	X	1	1	1
1	X	0	0	0

### Design Entry Method

This design element can be used in schematics.

### For More Information

- See the [Spartan-3 User Guide](#).
- See the [Spartan-3 Data Sheets](#).

## MUXF6\_L

Primitive: 2-to-1 Look-Up Table Multiplexer with Local Output

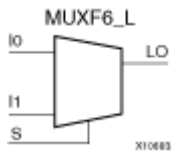

### Introduction

This design element provides a multiplexer function for use in creating a function-of-6 lookup table or an 8-to-1 multiplexer in combination with the associated four lookup tables and two MUXF5s. The local outputs (LO) from the two MUXF5s in the (CLB) are connected to the I0 and I1 inputs of the MUXF6. The (S) input is driven from any internal net. When Low, (S) selects I0. When High, (S) selects I1.

The LO output connects to other inputs in the same CLB slice.

### Logic Table

Inputs			Output
S	I0	I1	LO
0	1	X	1
0	0	X	0
1	X	1	1
1	X	0	0

### Design Entry Method

This design element can be used in schematics.

### For More Information

- See the [Spartan-3 User Guide](#).
- See the [Spartan-3 Data Sheets](#).



## MUXF7

Primitive: 2-to-1 Look-Up Table Multiplexer with General Output

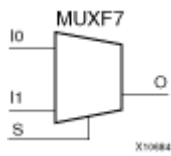

### Introduction

This design element provides a multiplexer function for use in creating a function-of-7 Look-Up Table or a 16-to-1 multiplexer in combination with the associated Look-Up Tables. Local outputs (LO) of MUXF6 are connected to the I0 and I1 inputs of the MUXF7. The (S) input is driven from any internal net. When Low, (S) selects I0. When High, (S) selects I1.

The variants, "MUXF7\_D" and "MUXF7\_L", provide additional types of outputs that can be used by different timing models for more accurate pre-layout timing estimation.

### Logic Table

Inputs			Outputs
S	I0	I1	O
0	I0	X	I0
1	X	I1	I1
X	0	0	0
X	1	1	1

### Port Descriptions

Name	Direction	Width	Function
O	Output	1-Bit	Output of MUX to general routing
I0	Input	1-Bit	Input (tie to MUXF6 LO out)
I1	Input	1-Bit	Input (tie to MUXF6 LO out)
S	Input	1-Bit	Input select to MUX

### Design Entry Method

This design element can be used in schematics.

### For More Information

- See the [Spartan-3 User Guide](#).
- See the [Spartan-3 Data Sheets](#).

## MUXF7\_D

Primitive: 2-to-1 Look-Up Table Multiplexer with Dual Output

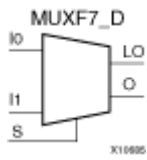

### Introduction

This design element provides a multiplexer function for use in creating a function-of-7 Look-Up Table or a 16-to-1 multiplexer in combination with the associated Look-Up Tables. Local outputs (LO) of MUXF6 are connected to the I0 and I1 inputs of the MUXF7. The S input is driven from any internal net. When Low, (S) selects I0. When High, (S) selects I1.

Outputs O and LO are functionally identical. The O output is a general interconnect. The LO output connects to other inputs in the same CLB slice.

### Logic Table

Inputs			Outputs	
S	I0	I1	O	LO
0	I0	X	I0	I0
1	X	I1	I1	I1
X	0	0	0	0
X	1	1	1	1

### Port Descriptions

Name	Direction	Width	Function
O	Output	1-Bit	Output of MUX to general routing
LO	Output	1-Bit	Output of MUX to local routing
I0	Input	1-Bit	Input (tie to MUXF6 LO out)
I1	Input	1-Bit	Input (tie to MUXF6 LO out)
S	Input	1-Bit	Input select to MUX

### Design Entry Method

This design element can be used in schematics.

### For More Information

- See the [Spartan-3 User Guide](#).
- See the [Spartan-3 Data Sheets](#).

## MUXF7\_L

Primitive: 2-to-1 Look-Up Table Multiplexer with Local Output

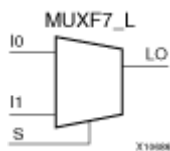

### Introduction

This design element provides a multiplexer function for use in creating a function-of-7 Look-Up Table or a 16-to-1 multiplexer in combination with the associated Look-Up Tables. Local outputs (LO) of MUXF6 are connected to the I0 and I1 inputs of the MUXF7. The S input is driven from any internal net. When Low, (S) selects I0. When High, (S) selects I1.

The LO output connects to other inputs in the same CLB slice.

### Logic Table

Inputs			Output
S	I0	I1	LO
0	I0	X	I0
1	X	I1	I1
X	0	0	0
X	1	1	1

### Port Descriptions

Name	Direction	Width	Function
LO	Output	1-Bit	Output of MUX to local routing
I0	Input	1-Bit	Input (tie to MUXF6 LO out)
I1	Input	1-Bit	Input (tie to MUXF6 LO out)
S	Input	1-Bit	Input select to MUX

### Design Entry Method

This design element can be used in schematics.

### For More Information

- See the [Spartan-3 User Guide](#).
- See the [Spartan-3 Data Sheets](#).

## MUXF8

Primitive: 2-to-1 Look-Up Table Multiplexer with General Output

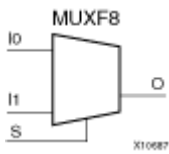

### Introduction

This design element provides a multiplexer function in eight slices for creating a function-of-8 Look-Up Table or a 32-to-1 multiplexer in combination with the associated Look-Up Tables, MUXF5s, MUXF6s, and MUXF7s. Local outputs (LO) of MUXF7 are connected to the I0 and I1 inputs of the MUXF8. The S input is driven from any internal net. When Low, (S) selects I0. When High, (S) selects I1.

### Logic Table

Inputs			Outputs
S	I0	I1	O
0	I0	X	I0
1	X	I1	I1
X	0	0	0
X	1	1	1

### Port Descriptions

Name	Direction	Width	Function
O	Output	1-Bit	Output of MUX to general routing
I0	Input	1-Bit	Input (tie to MUXF7 LO out)
I1	Input	1-Bit	Input (tie to MUXF7 LO out)
S	Input	1-Bit	Input select to MUX

### Design Entry Method

This design element can be used in schematics.

### For More Information

- See the [Spartan-3 User Guide](#).
- See the [Spartan-3 Data Sheets](#).

## MUXF8\_D

Primitive: 2-to-1 Look-Up Table Multiplexer with Dual Output

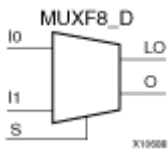

### Introduction

This design element provides a multiplexer function in eight slices for creating a function-of-8 Look-Up Table or a 32-to-1 multiplexer in combination with the associated four Look-Up Tables and two MUXF8s. Local outputs (LO) of MUXF7 are connected to the I0 and I1 inputs of the MUXF8. The S input is driven from any internal net. When Low, (S) selects I0. When High, (S) selects I1.

Outputs O and LO are functionally identical. The O output is a general interconnect. The LO output connects to other inputs in the same CLB slice.

### Logic Table

Inputs			Outputs	
S	I0	I1	O	LO
0	I0	X	I0	I0
1	X	I1	I1	I1
X	0	0	0	0
X	1	1	1	1

### Port Descriptions

Name	Direction	Width	Function
O	Output	1-Bit	Output of MUX to general routing
LO	Output	1-Bit	Output of MUX to local routing
I0	Input	1-Bit	Input (tie to MUXF7 LO out)
I1	Input	1-Bit	Input (tie to MUXF7 LO out)
S	Input	1-Bit	Input select to MUX

### Design Entry Method

This design element can be used in schematics.

### For More Information

- See the [Spartan-3 User Guide](#).
- See the [Spartan-3 Data Sheets](#).

## MUXF8\_L

Primitive: 2-to-1 Look-Up Table Multiplexer with Local Output

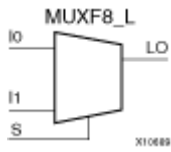

### Introduction

This design element provides a multiplexer function in eight slices for creating a function-of-8 Look-Up Table or a 32-to-1 multiplexer in combination with the associated four Look-Up Tables and two MUXF8s. Local outputs (LO) of MUXF7 are connected to the I0 and I1 inputs of the MUXF8. The S input is driven from any internal net. When Low, (S) selects I0. When High, (S) selects I1.

The LO output connects to other inputs in the same CLB slice.

### Logic Table

Inputs			Output
S	I0	I1	LO
0	I0	X	I0
1	X	I1	I1
X	0	0	0
X	1	1	1

### Port Descriptions

Name	Direction	Width	Function
LO	Output	1-Bit	Output of MUX to local routing
I0	Input	1-Bit	Input (tie to MUXF7 LO out)
I1	Input	1-Bit	Input (tie to MUXF7 LO out)
S	Input	1-Bit	Input select to MUX

### Design Entry Method

This design element can be used in schematics.

### For More Information

- See the [Spartan-3 User Guide](#).
- See the [Spartan-3 Data Sheets](#).

## NAND12

Macro: 12- Input NAND Gate with Non-Inverted Inputs

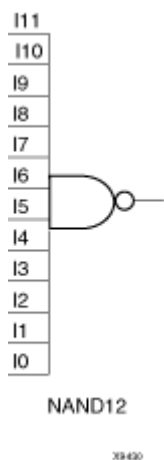

### Introduction

NAND gates of up to five inputs are available in any combination of inverting and non-inverting inputs. NAND gates of six to nine inputs, 12 inputs, and 16 inputs are available with only non-inverting inputs. To invert inputs, use external inverters. Because each input uses a CLB resource, replace gates with unused inputs with gates having the necessary number of inputs.

### Design Entry Method

This design element is only for use in schematics.

### For More Information

- See the [Spartan-3 User Guide](#).
- See the [Spartan-3 Data Sheets](#).

## NAND16

Macro: 16- Input NAND Gate with Non-Inverted Inputs

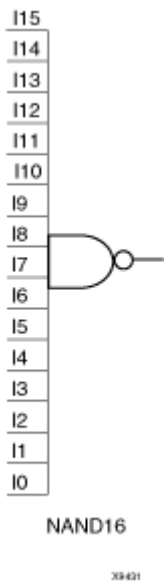

### Introduction

NAND gates of up to five inputs are available in any combination of inverting and non-inverting inputs. NAND gates of six to nine inputs, 12 inputs, and 16 inputs are available with only non-inverting inputs. To invert inputs, use external inverters. Because each input uses a CLB resource, replace gates with unused inputs with gates having the necessary number of inputs.

### Design Entry Method

This design element is only for use in schematics.

### For More Information

- See the [Spartan-3 User Guide](#).
- See the [Spartan-3 Data Sheets](#).



## NAND2

Primitive: 2-Input NAND Gate with Non-Inverted Inputs

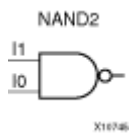

### Introduction

NAND gates of up to five inputs are available in any combination of inverting and non-inverting inputs. NAND gates of six to nine inputs, 12 inputs, and 16 inputs are available with only non-inverting inputs. To invert inputs, use external inverters. Because each input uses a CLB resource, replace gates with unused inputs with gates having the necessary number of inputs.

### Design Entry Method

This design element is only for use in schematics.

### For More Information

- See the [Spartan-3 User Guide](#).
- See the [Spartan-3 Data Sheets](#).

## NAND2B1

Primitive: 2-Input NAND Gate with 1 Inverted and 1 Non-Inverted Inputs



### Introduction

NAND gates of up to five inputs are available in any combination of inverting and non-inverting inputs. NAND gates of six to nine inputs, 12 inputs, and 16 inputs are available with only non-inverting inputs. To invert inputs, use external inverters. Because each input uses a CLB resource, replace gates with unused inputs with gates having the necessary number of inputs.

### Design Entry Method

This design element is only for use in schematics.

### For More Information

- See the [Spartan-3 User Guide](#).
- See the [Spartan-3 Data Sheets](#).

## NAND2B2

Primitive: 2-Input NAND Gate with Inverted Inputs

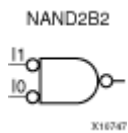

### Introduction

NAND gates of up to five inputs are available in any combination of inverting and non-inverting inputs. NAND gates of six to nine inputs, 12 inputs, and 16 inputs are available with only non-inverting inputs. To invert inputs, use external inverters. Because each input uses a CLB resource, replace gates with unused inputs with gates having the necessary number of inputs.

### Design Entry Method

This design element is only for use in schematics.

### For More Information

- See the [Spartan-3 User Guide](#).
- See the [Spartan-3 Data Sheets](#).

## NAND3

Primitive: 3-Input NAND Gate with Non-Inverted Inputs

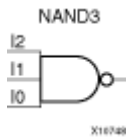

### Introduction

NAND gates of up to five inputs are available in any combination of inverting and non-inverting inputs. NAND gates of six to nine inputs, 12 inputs, and 16 inputs are available with only non-inverting inputs. To invert inputs, use external inverters. Because each input uses a CLB resource, replace gates with unused inputs with gates having the necessary number of inputs.

### Design Entry Method

This design element is only for use in schematics.

### For More Information

- See the [Spartan-3 User Guide](#).
- See the [Spartan-3 Data Sheets](#).

## NAND3B1

Primitive: 3-Input NAND Gate with 1 Inverted and 2 Non-Inverted Inputs

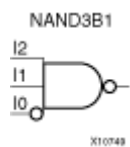

### Introduction

NAND gates of up to five inputs are available in any combination of inverting and non-inverting inputs. NAND gates of six to nine inputs, 12 inputs, and 16 inputs are available with only non-inverting inputs. To invert inputs, use external inverters. Because each input uses a CLB resource, replace gates with unused inputs with gates having the necessary number of inputs.

### Design Entry Method

This design element is only for use in schematics.

### For More Information

- See the [Spartan-3 User Guide](#).
- See the [Spartan-3 Data Sheets](#).

## NAND3B2

Primitive: 3-Input NAND Gate with 2 Inverted and 1 Non-Inverted Inputs

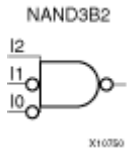

### Introduction

NAND gates of up to five inputs are available in any combination of inverting and non-inverting inputs. NAND gates of six to nine inputs, 12 inputs, and 16 inputs are available with only non-inverting inputs. To invert inputs, use external inverters. Because each input uses a CLB resource, replace gates with unused inputs with gates having the necessary number of inputs.

### Design Entry Method

This design element is only for use in schematics.

### For More Information

- See the [Spartan-3 User Guide](#).
- See the [Spartan-3 Data Sheets](#).

## NAND3B3

Primitive: 3-Input NAND Gate with Inverted Inputs

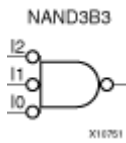

### Introduction

NAND gates of up to five inputs are available in any combination of inverting and non-inverting inputs. NAND gates of six to nine inputs, 12 inputs, and 16 inputs are available with only non-inverting inputs. To invert inputs, use external inverters. Because each input uses a CLB resource, replace gates with unused inputs with gates having the necessary number of inputs.

### Design Entry Method

This design element is only for use in schematics.

### For More Information

- See the [Spartan-3 User Guide](#).
- See the [Spartan-3 Data Sheets](#).

## NAND4

Primitive: 4-Input NAND Gate with Non-Inverted Inputs

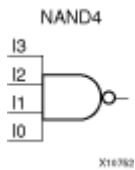

### Introduction

NAND gates of up to five inputs are available in any combination of inverting and non-inverting inputs. NAND gates of six to nine inputs, 12 inputs, and 16 inputs are available with only non-inverting inputs. To invert inputs, use external inverters. Because each input uses a CLB resource, replace gates with unused inputs with gates having the necessary number of inputs.

### Design Entry Method

This design element is only for use in schematics.

### For More Information

- See the [Spartan-3 User Guide](#).
- See the [Spartan-3 Data Sheets](#).



## NAND4B1

Primitive: 4-Input NAND Gate with 1 Inverted and 3 Non-Inverted Inputs

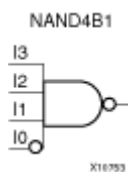

### Introduction

NAND gates of up to five inputs are available in any combination of inverting and non-inverting inputs. NAND gates of six to nine inputs, 12 inputs, and 16 inputs are available with only non-inverting inputs. To invert inputs, use external inverters. Because each input uses a CLB resource, replace gates with unused inputs with gates having the necessary number of inputs.

### Design Entry Method

This design element is only for use in schematics.

### For More Information

- See the [Spartan-3 User Guide](#).
- See the [Spartan-3 Data Sheets](#).

## NAND4B2

Primitive: 4-Input NAND Gate with 2 Inverted and 2 Non-Inverted Inputs

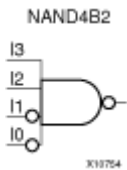

### Introduction

NAND gates of up to five inputs are available in any combination of inverting and non-inverting inputs. NAND gates of six to nine inputs, 12 inputs, and 16 inputs are available with only non-inverting inputs. To invert inputs, use external inverters. Because each input uses a CLB resource, replace gates with unused inputs with gates having the necessary number of inputs.

### Design Entry Method

This design element is only for use in schematics.

### For More Information

- See the [Spartan-3 User Guide](#).
- See the [Spartan-3 Data Sheets](#).

## NAND4B3

Primitive: 4-Input NAND Gate with 3 Inverted and 1 Non-Inverted Inputs

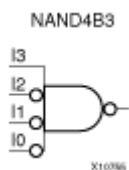

### Introduction

NAND gates of up to five inputs are available in any combination of inverting and non-inverting inputs. NAND gates of six to nine inputs, 12 inputs, and 16 inputs are available with only non-inverting inputs. To invert inputs, use external inverters. Because each input uses a CLB resource, replace gates with unused inputs with gates having the necessary number of inputs.

### Design Entry Method

This design element is only for use in schematics.

### For More Information

- See the [Spartan-3 User Guide](#).
- See the [Spartan-3 Data Sheets](#).

## NAND4B4

Primitive: 4-Input NAND Gate with Inverted Inputs

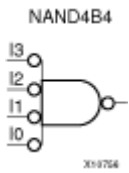

### Introduction

NAND gates of up to five inputs are available in any combination of inverting and non-inverting inputs. NAND gates of six to nine inputs, 12 inputs, and 16 inputs are available with only non-inverting inputs. To invert inputs, use external inverters. Because each input uses a CLB resource, replace gates with unused inputs with gates having the necessary number of inputs.

### Design Entry Method

This design element is only for use in schematics.

### For More Information

- See the [Spartan-3 User Guide](#).
- See the [Spartan-3 Data Sheets](#).

## NAND5

Primitive: 5-Input NAND Gate with Non-Inverted Inputs

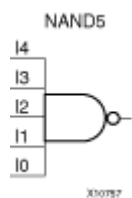

### Introduction

NAND gates of up to five inputs are available in any combination of inverting and non-inverting inputs. NAND gates of six to nine inputs, 12 inputs, and 16 inputs are available with only non-inverting inputs. To invert inputs, use external inverters. Because each input uses a CLB resource, replace gates with unused inputs with gates having the necessary number of inputs.

### Design Entry Method

This design element is only for use in schematics.

### For More Information

- See the [Spartan-3 User Guide](#).
- See the [Spartan-3 Data Sheets](#).

## NAND5B1

Primitive: 5-Input NAND Gate with 1 Inverted and 4 Non-Inverted Inputs

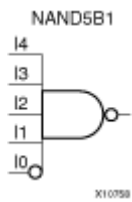

### Introduction

NAND gates of up to five inputs are available in any combination of inverting and non-inverting inputs. NAND gates of six to nine inputs, 12 inputs, and 16 inputs are available with only non-inverting inputs. To invert inputs, use external inverters. Because each input uses a CLB resource, replace gates with unused inputs with gates having the necessary number of inputs.

### Design Entry Method

This design element is only for use in schematics.

### For More Information

- See the [Spartan-3 User Guide](#).
- See the [Spartan-3 Data Sheets](#).

## NAND5B2

Primitive: 5-Input NAND Gate with 2 Inverted and 3 Non-Inverted Inputs

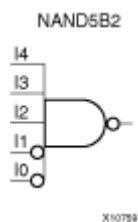

### Introduction

NAND gates of up to five inputs are available in any combination of inverting and non-inverting inputs. NAND gates of six to nine inputs, 12 inputs, and 16 inputs are available with only non-inverting inputs. To invert inputs, use external inverters. Because each input uses a CLB resource, replace gates with unused inputs with gates having the necessary number of inputs.

### Design Entry Method

This design element is only for use in schematics.

### For More Information

- See the [Spartan-3 User Guide](#).
- See the [Spartan-3 Data Sheets](#).

## NAND5B3

Primitive: 5-Input NAND Gate with 3 Inverted and 2 Non-Inverted Inputs

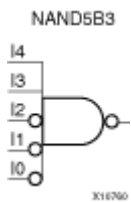

### Introduction

NAND gates of up to five inputs are available in any combination of inverting and non-inverting inputs. NAND gates of six to nine inputs, 12 inputs, and 16 inputs are available with only non-inverting inputs. To invert inputs, use external inverters. Because each input uses a CLB resource, replace gates with unused inputs with gates having the necessary number of inputs.

### Design Entry Method

This design element is only for use in schematics.

### For More Information

- See the [Spartan-3 User Guide](#).
- See the [Spartan-3 Data Sheets](#).



## NAND5B4

Primitive: 5-Input NAND Gate with 4 Inverted and 1 Non-Inverted Inputs

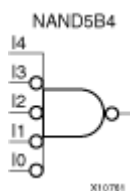

### Introduction

NAND gates of up to five inputs are available in any combination of inverting and non-inverting inputs. NAND gates of six to nine inputs, 12 inputs, and 16 inputs are available with only non-inverting inputs. To invert inputs, use external inverters. Because each input uses a CLB resource, replace gates with unused inputs with gates having the necessary number of inputs.

### Design Entry Method

This design element is only for use in schematics.

### For More Information

- See the [Spartan-3 User Guide](#).
- See the [Spartan-3 Data Sheets](#).

## NAND5B5

Primitive: 5-Input NAND Gate with Inverted Inputs

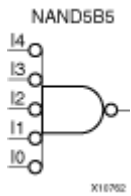

### Introduction

NAND gates of up to five inputs are available in any combination of inverting and non-inverting inputs. NAND gates of six to nine inputs, 12 inputs, and 16 inputs are available with only non-inverting inputs. To invert inputs, use external inverters. Because each input uses a CLB resource, replace gates with unused inputs with gates having the necessary number of inputs.

### Design Entry Method

This design element is only for use in schematics.

### For More Information

- See the [Spartan-3 User Guide](#).
- See the [Spartan-3 Data Sheets](#).

## NAND6

Macro: 6-Input NAND Gate with Non-Inverted Inputs

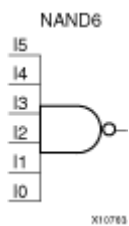

### Introduction

NAND gates of up to five inputs are available in any combination of inverting and non-inverting inputs. NAND gates of six to nine inputs, 12 inputs, and 16 inputs are available with only non-inverting inputs. To invert inputs, use external inverters. Because each input uses a CLB resource, replace gates with unused inputs with gates having the necessary number of inputs.

### Design Entry Method

This design element is only for use in schematics.

### For More Information

- See the [Spartan-3 User Guide](#).
- See the [Spartan-3 Data Sheets](#).

## NAND7

Macro: 7-Input NAND Gate with Non-Inverted Inputs

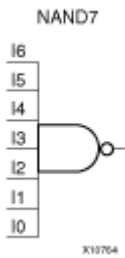

### Introduction

NAND gates of up to five inputs are available in any combination of inverting and non-inverting inputs. NAND gates of six to nine inputs, 12 inputs, and 16 inputs are available with only non-inverting inputs. To invert inputs, use external inverters. Because each input uses a CLB resource, replace gates with unused inputs with gates having the necessary number of inputs.

### Design Entry Method

This design element is only for use in schematics.

### For More Information

- See the [Spartan-3 User Guide](#).
- See the [Spartan-3 Data Sheets](#).

## NAND8

Macro: 8-Input NAND Gate with Non-Inverted Inputs

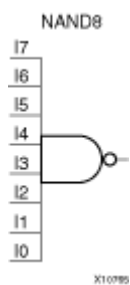

### Introduction

NAND gates of up to five inputs are available in any combination of inverting and non-inverting inputs. NAND gates of six to nine inputs, 12 inputs, and 16 inputs are available with only non-inverting inputs. To invert inputs, use external inverters. Because each input uses a CLB resource, replace gates with unused inputs with gates having the necessary number of inputs.

### Design Entry Method

This design element is only for use in schematics.

### For More Information

- See the [Spartan-3 User Guide](#).
- See the [Spartan-3 Data Sheets](#).

## NAND9

Macro: 9-Input NAND Gate with Non-Inverted Inputs

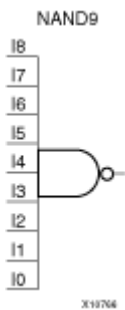

### Introduction

NAND gates of up to five inputs are available in any combination of inverting and non-inverting inputs. NAND gates of six to nine inputs, 12 inputs, and 16 inputs are available with only non-inverting inputs. To invert inputs, use external inverters. Because each input uses a CLB resource, replace gates with unused inputs with gates having the necessary number of inputs.

### Design Entry Method

This design element is only for use in schematics.

### For More Information

- See the [Spartan-3 User Guide](#).
- See the [Spartan-3 Data Sheets](#).

## NOR12

Macro: 12-Input NOR Gate with Non-Inverted Inputs

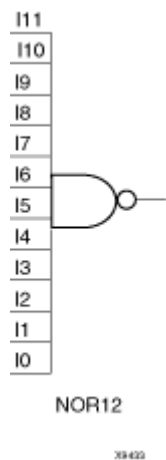

### Introduction

NOR gates of up to five inputs are available in any combination of inverting and non-inverting inputs. NOR gates of six to nine inputs, 12 inputs, and 16 inputs are available only with non-inverting inputs. To invert some or all inputs, use external inverters. Because each input uses a CLB resource, replace gates with unused inputs with gates having the necessary number of inputs.

### Design Entry Method

This design element is only for use in schematics.

### For More Information

- See the [Spartan-3 User Guide](#).
- See the [Spartan-3 Data Sheets](#).

## NOR16

Macro: 16-Input NOR Gate with Non-Inverted Inputs

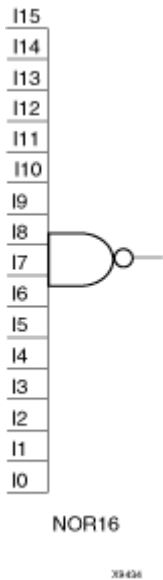

### Introduction

NOR gates of up to five inputs are available in any combination of inverting and non-inverting inputs. NOR gates of six to nine inputs, 12 inputs, and 16 inputs are available only with non-inverting inputs. To invert some or all inputs, use external inverters. Because each input uses a CLB resource, replace gates with unused inputs with gates having the necessary number of inputs.

### Design Entry Method

This design element is only for use in schematics.

### For More Information

- See the [Spartan-3 User Guide](#).
- See the [Spartan-3 Data Sheets](#).



## NOR2

Primitive: 2-Input NOR Gate with Non-Inverted Inputs

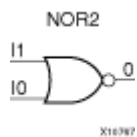

### Introduction

NOR gates of up to five inputs are available in any combination of inverting and non-inverting inputs. NOR gates of six to nine inputs, 12 inputs, and 16 inputs are available only with non-inverting inputs. To invert some or all inputs, use external inverters. Because each input uses a CLB resource, replace gates with unused inputs with gates having the necessary number of inputs.

### Design Entry Method

This design element is only for use in schematics.

### For More Information

- See the [Spartan-3 User Guide](#).
- See the [Spartan-3 Data Sheets](#).

## NOR2B1

Primitive: 2-Input NOR Gate with 1 Inverted and 1 Non-Inverted Inputs

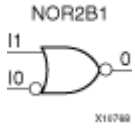

### Introduction

NOR gates of up to five inputs are available in any combination of inverting and non-inverting inputs. NOR gates of six to nine inputs, 12 inputs, and 16 inputs are available only with non-inverting inputs. To invert some or all inputs, use external inverters. Because each input uses a CLB resource, replace gates with unused inputs with gates having the necessary number of inputs.

### Design Entry Method

This design element is only for use in schematics.

### For More Information

- See the [Spartan-3 User Guide](#).
- See the [Spartan-3 Data Sheets](#).

## NOR2B2

Primitive: 2-Input NOR Gate with Inverted Inputs



### Introduction

NOR gates of up to five inputs are available in any combination of inverting and non-inverting inputs. NOR gates of six to nine inputs, 12 inputs, and 16 inputs are available only with non-inverting inputs. To invert some or all inputs, use external inverters. Because each input uses a CLB resource, replace gates with unused inputs with gates having the necessary number of inputs.

### Design Entry Method

This design element is only for use in schematics.

### For More Information

- See the [Spartan-3 User Guide](#).
- See the [Spartan-3 Data Sheets](#).

## NOR3

Primitive: 3-Input NOR Gate with Non-Inverted Inputs

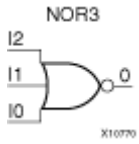

### Introduction

NOR gates of up to five inputs are available in any combination of inverting and non-inverting inputs. NOR gates of six to nine inputs, 12 inputs, and 16 inputs are available only with non-inverting inputs. To invert some or all inputs, use external inverters. Because each input uses a CLB resource, replace gates with unused inputs with gates having the necessary number of inputs.

### Design Entry Method

This design element is only for use in schematics.

### For More Information

- See the [Spartan-3 User Guide](#).
- See the [Spartan-3 Data Sheets](#).

## NOR3B1

Primitive: 3-Input NOR Gate with 1 Inverted and 2 Non-Inverted Inputs

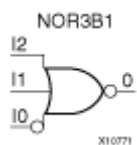

### Introduction

NOR gates of up to five inputs are available in any combination of inverting and non-inverting inputs. NOR gates of six to nine inputs, 12 inputs, and 16 inputs are available only with non-inverting inputs. To invert some or all inputs, use external inverters. Because each input uses a CLB resource, replace gates with unused inputs with gates having the necessary number of inputs.

### Design Entry Method

This design element is only for use in schematics.

### For More Information

- See the [Spartan-3 User Guide](#).
- See the [Spartan-3 Data Sheets](#).

## NOR3B2

Primitive: 3-Input NOR Gate with 2 Inverted and 1 Non-Inverted Inputs

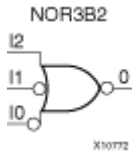

### Introduction

NOR gates of up to five inputs are available in any combination of inverting and non-inverting inputs. NOR gates of six to nine inputs, 12 inputs, and 16 inputs are available only with non-inverting inputs. To invert some or all inputs, use external inverters. Because each input uses a CLB resource, replace gates with unused inputs with gates having the necessary number of inputs.

### Design Entry Method

This design element is only for use in schematics.

### For More Information

- See the [Spartan-3 User Guide](#).
- See the [Spartan-3 Data Sheets](#).

## NOR3B3

Primitive: 3-Input NOR Gate with Inverted Inputs

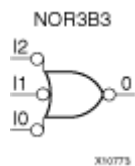

### Introduction

NOR gates of up to five inputs are available in any combination of inverting and non-inverting inputs. NOR gates of six to nine inputs, 12 inputs, and 16 inputs are available only with non-inverting inputs. To invert some or all inputs, use external inverters. Because each input uses a CLB resource, replace gates with unused inputs with gates having the necessary number of inputs.

### Design Entry Method

This design element is only for use in schematics.

### For More Information

- See the [Spartan-3 User Guide](#).
- See the [Spartan-3 Data Sheets](#).

## NOR4

Primitive: 4-Input NOR Gate with Non-Inverted Inputs

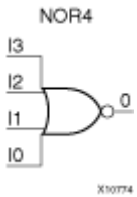

### Introduction

NOR gates of up to five inputs are available in any combination of inverting and non-inverting inputs. NOR gates of six to nine inputs, 12 inputs, and 16 inputs are available only with non-inverting inputs. To invert some or all inputs, use external inverters. Because each input uses a CLB resource, replace gates with unused inputs with gates having the necessary number of inputs.

### Design Entry Method

This design element is only for use in schematics.

### For More Information

- See the [Spartan-3 User Guide](#).
- See the [Spartan-3 Data Sheets](#).



## NOR4B1

Primitive: 4-Input NOR Gate with 1 Inverted and 3 Non-Inverted Inputs

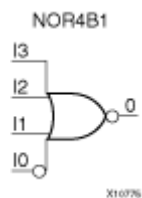

### Introduction

NOR gates of up to five inputs are available in any combination of inverting and non-inverting inputs. NOR gates of six to nine inputs, 12 inputs, and 16 inputs are available only with non-inverting inputs. To invert some or all inputs, use external inverters. Because each input uses a CLB resource, replace gates with unused inputs with gates having the necessary number of inputs.

### Design Entry Method

This design element is only for use in schematics.

### For More Information

- See the [Spartan-3 User Guide](#).
- See the [Spartan-3 Data Sheets](#).

## NOR4B2

Primitive: 4-Input NOR Gate with 2 Inverted and 2 Non-Inverted Inputs

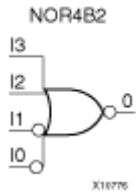

### Introduction

NOR gates of up to five inputs are available in any combination of inverting and non-inverting inputs. NOR gates of six to nine inputs, 12 inputs, and 16 inputs are available only with non-inverting inputs. To invert some or all inputs, use external inverters. Because each input uses a CLB resource, replace gates with unused inputs with gates having the necessary number of inputs.

### Design Entry Method

This design element is only for use in schematics.

### For More Information

- See the [Spartan-3 User Guide](#).
- See the [Spartan-3 Data Sheets](#).

## NOR4B3

Primitive: 4-Input NOR Gate with 3 Inverted and 1 Non-Inverted Inputs

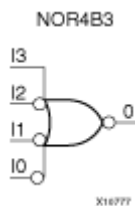

### Introduction

NOR gates of up to five inputs are available in any combination of inverting and non-inverting inputs. NOR gates of six to nine inputs, 12 inputs, and 16 inputs are available only with non-inverting inputs. To invert some or all inputs, use external inverters. Because each input uses a CLB resource, replace gates with unused inputs with gates having the necessary number of inputs.

### Design Entry Method

This design element is only for use in schematics.

### For More Information

- See the [Spartan-3 User Guide](#).
- See the [Spartan-3 Data Sheets](#).

## NOR4B4

Primitive: 4-Input NOR Gate with Inverted Inputs

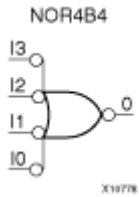

### Introduction

NOR gates of up to five inputs are available in any combination of inverting and non-inverting inputs. NOR gates of six to nine inputs, 12 inputs, and 16 inputs are available only with non-inverting inputs. To invert some or all inputs, use external inverters. Because each input uses a CLB resource, replace gates with unused inputs with gates having the necessary number of inputs.

### Design Entry Method

This design element is only for use in schematics.

### For More Information

- See the [Spartan-3 User Guide](#).
- See the [Spartan-3 Data Sheets](#).

## NOR5

Primitive: 5-Input NOR Gate with Non-Inverted Inputs

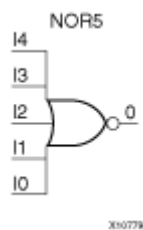

### Introduction

NOR gates of up to five inputs are available in any combination of inverting and non-inverting inputs. NOR gates of six to nine inputs, 12 inputs, and 16 inputs are available only with non-inverting inputs. To invert some or all inputs, use external inverters. Because each input uses a CLB resource, replace gates with unused inputs with gates having the necessary number of inputs.

### Design Entry Method

This design element is only for use in schematics.

### For More Information

- See the [Spartan-3 User Guide](#).
- See the [Spartan-3 Data Sheets](#).

## NOR5B1

Primitive: 5-Input NOR Gate with 1 Inverted and 4 Non-Inverted Inputs

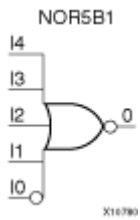

### Introduction

NOR gates of up to five inputs are available in any combination of inverting and non-inverting inputs. NOR gates of six to nine inputs, 12 inputs, and 16 inputs are available only with non-inverting inputs. To invert some or all inputs, use external inverters. Because each input uses a CLB resource, replace gates with unused inputs with gates having the necessary number of inputs.

### Design Entry Method

This design element is only for use in schematics.

### For More Information

- See the [Spartan-3 User Guide](#).
- See the [Spartan-3 Data Sheets](#).

## NOR5B2

Primitive: 5-Input NOR Gate with 2 Inverted and 3 Non-Inverted Inputs

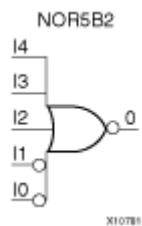

### Introduction

NOR gates of up to five inputs are available in any combination of inverting and non-inverting inputs. NOR gates of six to nine inputs, 12 inputs, and 16 inputs are available only with non-inverting inputs. To invert some or all inputs, use external inverters. Because each input uses a CLB resource, replace gates with unused inputs with gates having the necessary number of inputs.

### Design Entry Method

This design element is only for use in schematics.

### For More Information

- See the [Spartan-3 User Guide](#).
- See the [Spartan-3 Data Sheets](#).

## NOR5B3

Primitive: 5-Input NOR Gate with 3 Inverted and 2 Non-Inverted Inputs

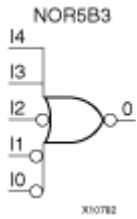

### Introduction

NOR gates of up to five inputs are available in any combination of inverting and non-inverting inputs. NOR gates of six to nine inputs, 12 inputs, and 16 inputs are available only with non-inverting inputs. To invert some or all inputs, use external inverters. Because each input uses a CLB resource, replace gates with unused inputs with gates having the necessary number of inputs.

### Design Entry Method

This design element is only for use in schematics.

### For More Information

- See the [Spartan-3 User Guide](#).
- See the [Spartan-3 Data Sheets](#).



## NOR5B4

Primitive: 5-Input NOR Gate with 4 Inverted and 1 Non-Inverted Inputs

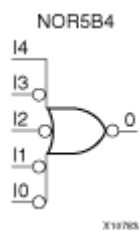

### Introduction

NOR gates of up to five inputs are available in any combination of inverting and non-inverting inputs. NOR gates of six to nine inputs, 12 inputs, and 16 inputs are available only with non-inverting inputs. To invert some or all inputs, use external inverters. Because each input uses a CLB resource, replace gates with unused inputs with gates having the necessary number of inputs.

### Design Entry Method

This design element is only for use in schematics.

### For More Information

- See the [Spartan-3 User Guide](#).
- See the [Spartan-3 Data Sheets](#).

## NOR5B5

Primitive: 5-Input NOR Gate with Inverted Inputs

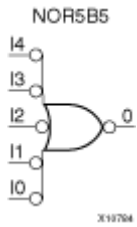

### Introduction

NOR gates of up to five inputs are available in any combination of inverting and non-inverting inputs. NOR gates of six to nine inputs, 12 inputs, and 16 inputs are available only with non-inverting inputs. To invert some or all inputs, use external inverters. Because each input uses a CLB resource, replace gates with unused inputs with gates having the necessary number of inputs.

### Design Entry Method

This design element is only for use in schematics.

### For More Information

- See the [Spartan-3 User Guide](#).
- See the [Spartan-3 Data Sheets](#).

## NOR6

Macro: 6-Input NOR Gate with Non-Inverted Inputs

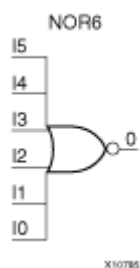

### Introduction

NOR gates of up to five inputs are available in any combination of inverting and non-inverting inputs. NOR gates of six to nine inputs, 12 inputs, and 16 inputs are available only with non-inverting inputs. To invert some or all inputs, use external inverters. Because each input uses a CLB resource, replace gates with unused inputs with gates having the necessary number of inputs.

### Design Entry Method

This design element is only for use in schematics.

### For More Information

- See the [Spartan-3 User Guide](#).
- See the [Spartan-3 Data Sheets](#).

## NOR7

Macro: 7-Input NOR Gate with Non-Inverted Inputs

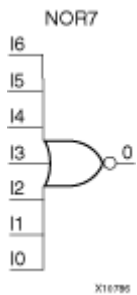

### Introduction

NOR gates of up to five inputs are available in any combination of inverting and non-inverting inputs. NOR gates of six to nine inputs, 12 inputs, and 16 inputs are available only with non-inverting inputs. To invert some or all inputs, use external inverters. Because each input uses a CLB resource, replace gates with unused inputs with gates having the necessary number of inputs.

### Design Entry Method

This design element is only for use in schematics.

### For More Information

- See the [Spartan-3 User Guide](#).
- See the [Spartan-3 Data Sheets](#).

## NOR8

Macro: 8-Input NOR Gate with Non-Inverted Inputs

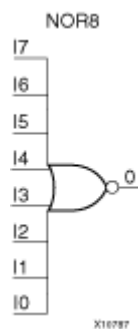

### Introduction

NOR gates of up to five inputs are available in any combination of inverting and non-inverting inputs. NOR gates of six to nine inputs, 12 inputs, and 16 inputs are available only with non-inverting inputs. To invert some or all inputs, use external inverters. Because each input uses a CLB resource, replace gates with unused inputs with gates having the necessary number of inputs.

### Design Entry Method

This design element is only for use in schematics.

### For More Information

- See the [Spartan-3 User Guide](#).
- See the [Spartan-3 Data Sheets](#).

## NOR9

Macro: 9-Input NOR Gate with Non-Inverted Inputs

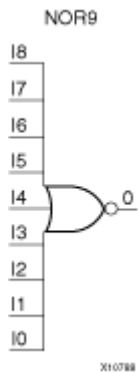

### Introduction

NOR gates of up to five inputs are available in any combination of inverting and non-inverting inputs. NOR gates of six to nine inputs, 12 inputs, and 16 inputs are available only with non-inverting inputs. To invert some or all inputs, use external inverters. Because each input uses a CLB resource, replace gates with unused inputs with gates having the necessary number of inputs.

### Design Entry Method

This design element is only for use in schematics.

### For More Information

- See the [Spartan-3 User Guide](#).
- See the [Spartan-3 Data Sheets](#).

## OBUF

Primitive: Output Buffer

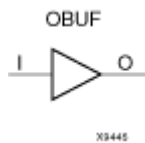

### Introduction

This design element is a simple output buffer used to drive output signals to the FPGA device pins that do not need to be 3-stated (constantly driven). Either an OBUF, OBUFT, OBUFDS, or OBUFTDS must be connected to every output port in the design.

This element isolates the internal circuit and provides drive current for signals leaving a chip. It exists in input/output blocks (IOB). Its output (O) is connected to an OPAD or an IOPAD. The interface standard used by this element is LVTTTL. Also, this element has selectable drive and slew rates using the DRIVE and SLOW or FAST constraints. The defaults are DRIVE=12 mA and SLOW slew.

### Port Descriptions

Name	Direction	Width	Function
O	Output	1-bit	Output of OBUF to be connected directly to top-level output port.
I	Input	1-bit	Input of OBUF. Connect to the logic driving the output port.

This design element can be used in schematics.

### Available Attributes

Attribute	Type	Allowed Values	Default	Description
DRIVE	Integer	2, 4, 6, 8, 12, 16, 24	12	Specifies the output current drive strength of the I/O. It is suggested that you set this to the lowest setting tolerable for the design drive and timing requirements.
IOSTANDARD	String	Consult the product Data Sheet.	"DEFAULT"	Specifies the I/O standard to be used for this output.
SLEW	String	"SLOW" or "FAST"	"SLOW"	Specifies the slew rate of the output driver. Consult the product Data Sheet for recommendations of the best setting for this attribute.

### For More Information

- See the [Spartan-3 User Guide](#).
- See the [Spartan-3 Data Sheets](#).

## OBUF16

Macro: 16-Bit Output Buffer



### Introduction

This design element is a multiple output buffer.

This element isolates the internal circuit and provides drive current for signals leaving a chip. It exists in input/output blocks (IOB). Its output (O) is connected to an OPAD or an IOPAD. The interface standard used by this element is LVTTTL. Also, this element has selectable drive and slew rates using the DRIVE and SLOW or FAST constraints. The defaults are DRIVE=12 mA and SLOW slew.

This design element can be used in schematics.

### Available Attributes

Attribute	Type	Allowed Values	Default	Description
DRIVE	Integer	2, 4, 6, 8, 12, 16, 24	12	Specifies the output current drive strength of the I/O. It is suggested that you set this to the lowest setting tolerable for the design drive and timing requirements.
IOSTANDARD	String	Consult the product Data Sheet.	"DEFAULT"	Specifies the I/O standard to be used for this output.
SLEW	String	"SLOW" or "FAST"	"SLOW"	Specifies the slew rate of the output driver. Consult the product Data Sheet for recommendations of the best setting for this attribute.

### For More Information

- See the [Spartan-3 User Guide](#).
- See the [Spartan-3 Data Sheets](#).



## OBUF4

Macro: 4-Bit Output Buffer

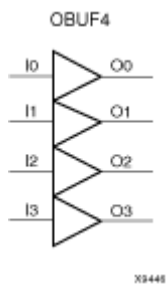

### Introduction

This design element is a multiple output buffer.

This element isolates the internal circuit and provides drive current for signals leaving a chip. It exists in input/output blocks (IOB). Its output (O) is connected to an OPAD or an IOPAD. The interface standard used by this element is LVTTTL. Also, this element has selectable drive and slew rates using the DRIVE and SLOW or FAST constraints. The defaults are DRIVE=12 mA and SLOW slew.

This design element can be used in schematics.

### Available Attributes

Attribute	Type	Allowed Values	Default	Description
DRIVE	Integer	2, 4, 6, 8, 12, 16, 24	12	Specifies the output current drive strength of the I/O. It is suggested that you set this to the lowest setting tolerable for the design drive and timing requirements.
IOSTANDARD	String	Consult the product Data Sheet.	"DEFAULT"	Specifies the I/O standard to be used for this output.
SLEW	String	"SLOW" or "FAST"	"SLOW"	Specifies the slew rate of the output driver. Consult the product Data Sheet for recommendations of the best setting for this attribute.

### For More Information

- See the [Spartan-3 User Guide](#).
- See the [Spartan-3 Data Sheets](#).

## OBUF8

Macro: 8-Bit Output Buffer

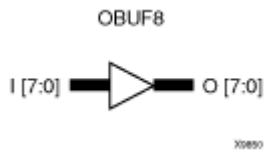

### Introduction

This design element is a multiple output buffer.

This element isolates the internal circuit and provides drive current for signals leaving a chip. It exists in input/output blocks (IOB). Its output (O) is connected to an OPAD or an IOPAD. The interface standard used by this element is LVTTTL. Also, this element has selectable drive and slew rates using the DRIVE and SLOW or FAST constraints. The defaults are DRIVE=12 mA and SLOW slew.

This design element can be used in schematics.

### Available Attributes

Attribute	Type	Allowed Values	Default	Description
DRIVE	Integer	2, 4, 6, 8, 12, 16, 24	12	Specifies the output current drive strength of the I/O. It is suggested that you set this to the lowest setting tolerable for the design drive and timing requirements.
IOSTANDARD	String	Consult the product Data Sheet.	"DEFAULT"	Specifies the I/O standard to be used for this output.
SLEW	String	"SLOW" or "FAST"	"SLOW"	Specifies the slew rate of the output driver. Consult the product Data Sheet for recommendations of the best setting for this attribute.

### For More Information

- See the [Spartan-3 User Guide](#).
- See the [Spartan-3 Data Sheets](#).

## OBUFDS

Primitive: Differential Signaling Output Buffer

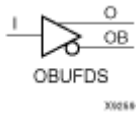

### Introduction

This design element is a single output buffer that supports low-voltage, differential signaling (1.8 v CMOS). OBUFDS isolates the internal circuit and provides drive current for signals leaving the chip. Its output is represented as two distinct ports (O and OB), one deemed the "master" and the other the "slave." The master and the slave are opposite phases of the same logical signal (for example, MYNET and MYNETB).

### Logic Table

Inputs		Outputs
I	O	OB
0	0	1
1	1	0

### Port Descriptions

Name	Direction	Width	Function
O	Output	1-Bit	Diff_p output (connect directly to top level port)
OB	Input	1-Bit	Diff_n output (connect directly to top level port)
I	Input	1-Bit	Buffer input

### Design Entry Method

This design element can be used in schematics.

### Available Attributes

Attribute	Type	Allowed Values	Default	Descriptions
IOSTANDARD	String	"DEFAULT"	"DEFAULT"	Use to assign an I/O standard to an I/O primitive.

### For More Information

- See the [Spartan-3 User Guide](#).
- See the [Spartan-3 Data Sheets](#).

## OBUFT

Primitive: 3-State Output Buffer with Active Low Output Enable

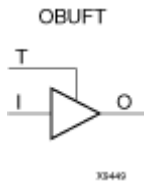

### Introduction

This design element is a single, 3-state output buffer with input I, output O, and active-Low output enables (T). This element uses the LVTTTL standard and has selectable drive and slew rates using the DRIVE and SLOW or FAST constraints. The defaults are DRIVE=12 mA and SLOW slew.

When T is Low, data on the inputs of the buffers is transferred to the corresponding outputs. When T is High, the output is high impedance (off or Z state). OBUFTs are generally used when a single-ended output is needed with a 3-state capability, such as the case when building bidirectional I/O.

### Logic Table

Inputs		Outputs
T	I	O
1	X	Z
0	I	F

### Port Descriptions

Name	Direction	Width	Function
O	Output	1-Bit	Buffer output (connect directly to top-level port)
I	Input	1-Bit	Buffer input
T	Input	1-Bit	3-state enable input

### Design Entry Method

This design element can be used in schematics.

### Available Attributes

Attribute	Type	Allowed Values	Default	Description
DRIVE	Integer	2, 4, 6, 8, 12, 16, 24	12	Specifies the output current drive strength of the I/O. It is suggested that you set this to the lowest setting tolerable for the design drive and timing requirements.
IOSTANDARD	String	Consult the product Data Sheet.	"DEFAULT"	Specifies the I/O standard to be used for this output.
SLEW	String	"SLOW" or "FAST"	"SLOW"	Specifies the slew rate of the output driver. Consult the product Data Sheet for recommendations of the best setting for this attribute.

---

## For More Information

- See the [Spartan-3 User Guide](#).
- See the [Spartan-3 Data Sheets](#).

## OBUFTDS

Primitive: 3-State Output Buffer with Differential Signaling, Active-Low Output Enable

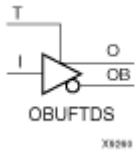

### Introduction

This design element is an output buffer that supports low-voltage, differential signaling. For the OBUFTDS, a design level interface signal is represented as two distinct ports (O and OB), one deemed the "master" and the other the "slave." The master and the slave are opposite phases of the same logical signal (for example, MYNET\_P and MYNET\_N).

### Logic Table

Inputs		Outputs	
I	T	O	OB
X	1	Z	Z
0	0	0	1
1	0	1	0

### Port Descriptions

Name	Direction	Width	Function
O	Output	1-Bit	Diff_p output (connect directly to top level port)
OB	Output	1-Bit	Diff_n output (connect directly to top level port)
I	Input	1-Bit	Buffer input
T	Input	1-Bit	3-state enable input

### Design Entry Method

This design element can be used in schematics.

### Available Attributes

Attribute	Type	Allowed Values	Default	Descriptions
IOSTANDARD	String	"DEFAULT"	"DEFAULT"	Use to assign an I/O standard to an I/O primitive.

### For More Information

- See the [Spartan-3 User Guide](#).
- See the [Spartan-3 Data Sheets](#).

## OFD

Macro: Output D Flip-Flop

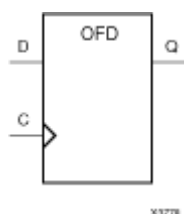

### Introduction

This design element is a single output D flip-flop.

The outputs are connected to OPADs or IOPADs. The data on the (D) inputs is loaded into the flip-flops during the Low-to-High clock (C) transition and appears on the (Q) outputs.

This flip-flop is asynchronously cleared, outputs Low, when power is applied. For FPGA devices, power-on conditions are simulated when global set/reset (GSR) is active. GSR defaults to active-High but can be inverted by adding an inverter in front of the GSR input of the appropriate *STARTUP\_architecture* symbol.

### Logic Table

Inputs		Outputs
D	C	Q
D	↑	D

### Design Entry Method

This design element is only for use in schematics.

### For More Information

- See the [Spartan-3 User Guide](#).
- See the [Spartan-3 Data Sheets](#).

## OFD\_1

Macro: Output D Flip-Flop with Inverted Clock

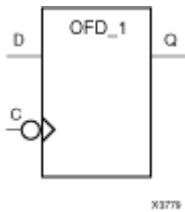

### Introduction

The design element is located in an input/output block (IOB). The output (Q) of the D flip-flop is connected to an OPAD or an IOPAD. The data on the (D) input is loaded into the flip-flop during the High-to-Low clock (C) transition and appears on the (Q) output.

This flip-flop is asynchronously cleared, outputs Low, when power is applied. For FPGA devices, power-on conditions are simulated when global set/reset (GSR) is active. GSR defaults to active-High but can be inverted by adding an inverter in front of the GSR input of the appropriate `STARTUP_architecture` symbol.

### Logic Table

Inputs		Outputs
D	C	Q
D	↓	D

### Design Entry Method

This design element is only for use in schematics.

### For More Information

- See the [Spartan-3 User Guide](#).
- See the [Spartan-3 Data Sheets](#).



# OFD16

Macro: 16-Bit Output D Flip-Flop

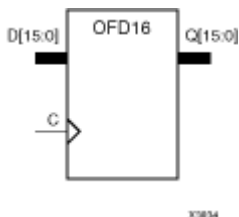

## Introduction

This design element is a multiple output D flip-flop.

The outputs are connected to OPADs or IOPADs. The data on the (D) inputs is loaded into the flip-flops during the Low-to-High clock (C) transition and appears on the (Q) outputs.

This flip-flop is asynchronously cleared, outputs Low, when power is applied. For FPGA devices, power-on conditions are simulated when global set/reset (GSR) is active. GSR defaults to active-High but can be inverted by adding an inverter in front of the GSR input of the appropriate `STARTUP_architecture` symbol.

## Logic Table

Inputs		Outputs
D	C	Q
D	↑	D

## Design Entry Method

This design element is only for use in schematics.

## For More Information

- See the [Spartan-3 User Guide](#).
- See the [Spartan-3 Data Sheets](#).

## OFD4

Macro: 4-Bit Output D Flip-Flop

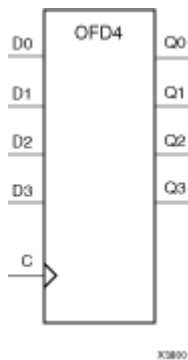

### Introduction

This design element is a multiple output D flip-flop.

The outputs are connected to OPADs or IOPADs. The data on the (D) inputs is loaded into the flip-flops during the Low-to-High clock (C) transition and appears on the (Q) outputs.

This flip-flop is asynchronously cleared, outputs Low, when power is applied. For FPGA devices, power-on conditions are simulated when global set/reset (GSR) is active. GSR defaults to active-High but can be inverted by adding an inverter in front of the GSR input of the appropriate `STARTUP_architecture` symbol.

### Logic Table

Inputs		Outputs
D	C	Q
D	↑	D

### Design Entry Method

This design element is only for use in schematics.

### For More Information

- See the [Spartan-3 User Guide](#).
- See the [Spartan-3 Data Sheets](#).

## OFD8

Macro: 8-Bit Output D Flip-Flop

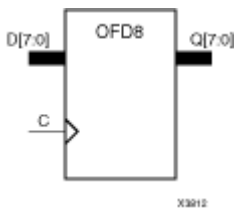

### Introduction

This design element is a multiple output D flip-flop.

The outputs are connected to OPADs or IOPADs. The data on the (D) inputs is loaded into the flip-flops during the Low-to-High clock (C) transition and appears on the (Q) outputs.

This flip-flop is asynchronously cleared, outputs Low, when power is applied. For FPGA devices, power-on conditions are simulated when global set/reset (GSR) is active. GSR defaults to active-High but can be inverted by adding an inverter in front of the GSR input of the appropriate `STARTUP_architecture` symbol.

### Logic Table

Inputs		Outputs
D	C	Q
D	↑	D

### Design Entry Method

This design element is only for use in schematics.

### For More Information

- See the [Spartan-3 User Guide](#).
- See the [Spartan-3 Data Sheets](#).

## OFDDRCPE

Primitive: Dual Data Rate Output D Flip-Flop with Clock Enable and Asynchronous Preset and Clear

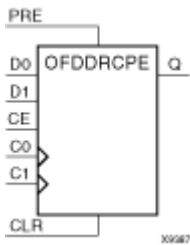

### Introduction

This design element is a dual data rate (DDR) output D flip-flop with clock enable (CE) and asynchronous preset (PRE) and clear (CLR). It consists of one output buffer and one dual data rate flip-flop (FDDRCPE). When the asynchronous PRE is High and CLR is Low, the Q output is preset High.

When CLR is High, Q is set Low. Data on the D0 input is loaded into the flip-flop when PRE and CLR are Low and CE is High on the Low-to-High C0 clock transition. Data on the D1 input is loaded into the flip-flop when PRE and CLR are Low and CE is High on the Low-to-High C1 clock transition. The INIT attribute does not apply to OFDDRCPE components.

This flip-flop is asynchronously cleared, outputs Low, when power is applied. For FPGA devices, power-on conditions are simulated when global set/reset (GSR) is active. GSR defaults to active-High but can be inverted by adding an inverter in front of the GSR input of the appropriate STARTUP\_ *architecture* symbol.

### Logic Table

Inputs							Outputs
C0	C1	CE	D0	D1	CLR	PRE	Q
X	X	X	X	X	1	0	0
X	X	X	X	X	0	1	1
X	X	X	X	X	1	1	0
X	X	0	X	X	0	0	No
↑	X	1	D0	X	0	0	D0
X	↑	1	X	D1	0	0	D1

### Design Entry Method

This design element can be used in schematics.

### For More Information

- See the [Spartan-3 User Guide](#).
- See the [Spartan-3 Data Sheets](#).

## OFDDRSE

Primitive: Dual Data Rate Output D Flip-Flop with Synchronous Reset and Set and Clock Enable

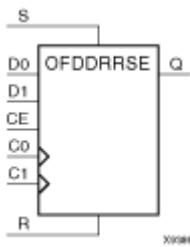

### Introduction

This design element is a dual data rate (DDR) output D flip-flop with synchronous reset (R) and set (S) and clock enable (CE). It consists of one output buffer and one dual data rate flip-flop (FDDRSE).

On a Low-to-High clock transition (C0 or C1), a High R input resets the Q output Low; a Low R input with a High S input sets Q High. When both R and S are Low and clock enable is High, data on the D0 input is loaded into the flip-flop on a Low-to-High C0 clock transition and data on the D1 input is loaded into the flip-flop on a Low-to-High C1 clock transition.

This flip-flop is asynchronously cleared, outputs Low, when power is applied. For FPGA devices, power-on conditions are simulated when global set/reset (GSR) is active. GSR defaults to active-High but can be inverted by adding an inverter in front of the GSR input of the appropriate `STARTUP_architecture` symbol.

The INIT attribute does not apply to this design element.

### Logic Table

Inputs							Outputs
C0	C1	CE	D0	D1	R	S	Q
↑	X	X	X	X	1	0	0
↑	X	X	X	X	0	1	1
↑	X	X	X	X	1	1	0
X	↑	X	X	X	1	0	0
X	↑	X	X	X	0	1	1
X	↑	X	X	X	1	1	0
X	X	0	X	X	0	0	No Change
↑	X	1	D0	X	0	0	D0
X	↑	1	X	D1	0	0	D1

### Design Entry Method

This design element can be used in schematics.

### For More Information

- See the [Spartan-3 User Guide](#).
- See the [Spartan-3 Data Sheets](#).

## OFDDRTCPE

Primitive: Dual Data Rate D Flip-Flop with Active-Low 3-State Output Buffer, Clock Enable, and Asynchronous Preset and Clear

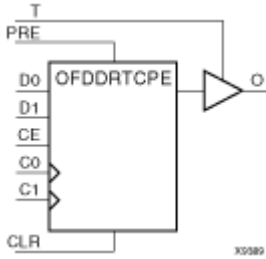

### Introduction

This design element is a dual data rate (DDR) D flip-flop with clock enable (CE) and asynchronous preset and clear whose output is enabled by a 3-state buffer. It consists of a dual data rate flip-flop (FDDRCPE) and a 3-state output buffer (OBUFT). The data output (O) of the flip-flop is connected to the input of the output buffer (OBUFT). The output of the OBUFT is connected to an OPAD or IOPAD.

When the active-Low enable input (T) is Low, output is enabled and the data on the flip-flop's Q output appears on the OBUFT's O output. When the asynchronous PRE is High and CLR is Low, the O output is preset High. When CLR is High, O is set Low. Data on the D0 input is loaded into the flip-flop when PRE and CLR are Low and CE is High on the Low-to-High C0 clock transition. Data on the D1 input is loaded into the flip-flop when PRE and CLR are Low and CE is High on the Low-to-High C1 clock transition.

When T is High, outputs are high impedance (Off). When CE is Low and T is Low, the outputs do not change.

This flip-flop is asynchronously cleared, outputs Low, when power is applied. For FPGA devices, power-on conditions are simulated when global set/reset (GSR) is active. GSR defaults to active-High but can be inverted by adding an inverter in front of the GSR input of the appropriate `STARTUP_architecture` symbol.

The INIT attribute does not apply to this design element.

### Logic Table

Inputs								Outputs
C0	C1	CE	D0	D1	CLR	PRE	T	O
X	X	X	X	X	X	X	1	Z
X	X	X	X	X	1	0	0	0
X	X	X	X	X	0	1	0	1
X	X	X	X	X	1	1	0	0
X	X	0	X	X	0	0	0	No Change
↑	X	1	D0	X	0	0	0	D0
X	↑	1	X	D1	0	0	0	D1

### Design Entry Method

This design element can be used in schematics.

---

## For More Information

- See the [Spartan-3 User Guide](#).
- See the [Spartan-3 Data Sheets](#).

## OFDDRTRSE

Primitive: Dual Data Rate D Flip-Flop with Active -Low 3-State Output Buffer, Synchronous Reset and Set, and Clock Enable

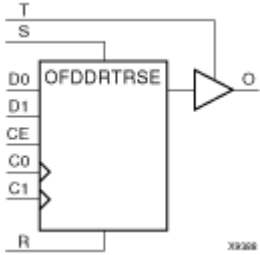

### Introduction

This design element is a dual data rate (DDR) D flip-flop with clock enable (CE) and synchronous reset and set whose output is enabled by a 3-state buffer. It consists of a dual data rate flip-flop (FDDRRSE) and a 3-state output buffer (OBUFT). The data output (O) of the flip-flop is connected to the input of the output buffer (OBUFT). The output of the OBUFT is connected to an OPAD or IOPAD.

When the active-Low enable input (T) is Low, output is enabled and the data on the flip-flop's Q output appears on the OBUFT's O output. On a Low-to-High clock transition (C0 or C1), a High R input resets the Q output Low; a Low R input with a High S input sets O High. When both R and S are Low and clock enable is High, data on the D0 input is loaded into the flip-flop on a Low-to-High C0 clock transition and data on the D1 input is loaded into the flip-flop on a Low-to-High C1 clock transition.

When T is High, outputs are high impedance (Off). When CE is Low and T is Low, the outputs do not change.

This flip-flop is asynchronously cleared, outputs Low, when power is applied. For FPGA devices, power-on conditions are simulated when global set/reset (GSR) is active. GSR defaults to active-High but can be inverted by adding an inverter in front of the GSR input of the appropriate `STARTUP_architecture` symbol.

The INIT attribute does not apply to this design elements components

### Logic Table

Inputs								Outputs
C0	C1	CE	D0	D1	R	S	T	O
X	X	X	X	X	X	X	1	Z
↑	X	X	X	X	1	0	0	0
↑	X	X	X	X	0	1	0	1
↑	X	X	X	X	1	1	0	0
X	↑	X	X	X	1	0	0	0
X	↑	X	X	X	0	1	0	1
X	↑	X	X	X	1	1	0	0
X	X	0	X	X	0	0	0	No Change
↑	X	1	D0	X	0	0	0	D0
X	↑	1	X	D1	0	0	0	D1



---

## Design Entry Method

This design element can be used in schematics.

## For More Information

- See the [Spartan-3 User Guide](#).
- See the [Spartan-3 Data Sheets](#).

## OFDE

Macro: D Flip-Flop with Active-High Enable Output Buffers

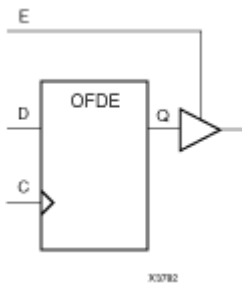

### Introduction

This is a single D flip-flop whose output is enabled by a 3-state buffer. The flip-flop data output (Q) is connected to the input of output buffer (OBUFE). The OBUFE output (O) is connected to an OPAD or IOPAD. The data on the data input (D) is loaded into the flip-flop during the Low-to-High clock (C) transition. When the active-High enable input (E) is High, the data on the flip-flop output (Q) appears on the OBUFE (O) output. When (E) is Low, the output is high impedance (Z state or Off).

This flip-flop is asynchronously cleared, outputs Low, when power is applied. For FPGA devices, power-on conditions are simulated when global set/reset (GSR) is active. GSR defaults to active-High but can be inverted by adding an inverter in front of the GSR input of the appropriate `STARTUP_architecture` symbol.

### Logic Table

Inputs			Output
E	D	C	O
0	X	X	Z
1	Dn	↑	Dn

### Design Entry Method

This design element is only for use in schematics.

### For More Information

- See the [Spartan-3 User Guide](#).
- See the [Spartan-3 Data Sheets](#).

## OFDE\_1

Macro: D Flip-Flop with Active-High Enable Output Buffer and Inverted Clock

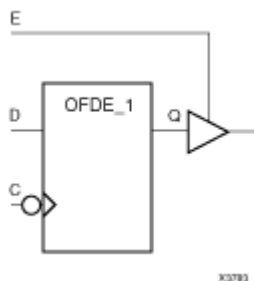

### Introduction

This design element and its output buffer are located in an input/output block (IOB). The data output of the flip-flop (Q) is connected to the input of an output buffer or OBUFE. The output of the OBUFE is connected to an OPAD or an IOPAD. The data on the data input (D) is loaded into the flip-flop on the High-to-Low clock (C) transition. When the active-High enable input (E) is High, the data on the flip-flop output (Q) appears on the (O) output. When (E) is Low, the output is high impedance (Z state or Off).

This flip-flop is asynchronously cleared, outputs Low, when power is applied. For FPGA devices, power-on conditions are simulated when global set/reset (GSR) is active. GSR defaults to active-High but can be inverted by adding an inverter in front of the GSR input of the appropriate `STARTUP_architecture` symbol.

### Logic Table

Inputs			Outputs
E	D	C	O
0	X	X	Z
1	D	↓	D

### Design Entry Method

This design element is only for use in schematics.

### For More Information

- See the [Spartan-3 User Guide](#).
- See the [Spartan-3 Data Sheets](#).

## OFDE16

Macro: 16-Bit D Flip-Flop with Active-High Enable Output Buffers

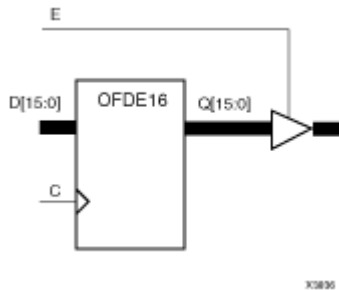

### Introduction

This is a multiple D flip-flop whose outputs are enabled by 3-state buffers. The flip-flop data outputs (Q) are connected to the inputs of output buffers (OBUFE). The OBUFE outputs (O) are connected to OPADs or IOPADs. The data on the data inputs (D) is loaded into the flip-flops during the Low-to-High clock (C) transition. When the active-High enable inputs (E) are High, the data on the flip-flop outputs (Q) appears on the OBUFE outputs (O). When (E) is Low, outputs are high impedance (Z state or Off).

This flip-flop is asynchronously cleared, outputs Low, when power is applied. For FPGA devices, power-on conditions are simulated when global set/reset (GSR) is active. GSR defaults to active-High but can be inverted by adding an inverter in front of the GSR input of the appropriate `STARTUP_architecture` symbol.

### Logic Table

Inputs			Outputs
E	D	C	O
0	X	X	Z
1	Dn	↑	Dn

### Design Entry Method

This design element is only for use in schematics.

### For More Information

- See the [Spartan-3 User Guide](#).
- See the [Spartan-3 Data Sheets](#).

## OFDE4

Macro: 4-Bit D Flip-Flop with Active-High Enable Output Buffers

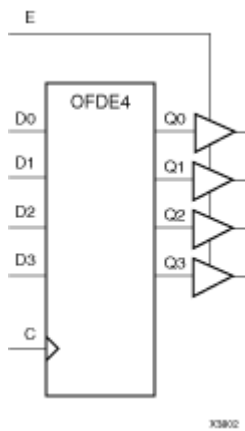

### Introduction

This is a multiple D flip-flop whose outputs are enabled by 3-state buffers. The flip-flop data outputs (Q) are connected to the inputs of output buffers (OBUFE). The OBUFE outputs (O) are connected to OPADs or IOPADs. The data on the data inputs (D) is loaded into the flip-flops during the Low-to-High clock (C) transition. When the active-High enable inputs (E) are High, the data on the flip-flop outputs (Q) appears on the OBUFE outputs (O). When (E) is Low, outputs are high impedance (Z state or Off).

This flip-flop is asynchronously cleared, outputs Low, when power is applied. For FPGA devices, power-on conditions are simulated when global set/reset (GSR) is active. GSR defaults to active-High but can be inverted by adding an inverter in front of the GSR input of the appropriate `STARTUP_architecture` symbol.

### Logic Table

Inputs			Outputs
E	D	C	O
0	X	X	Z
1	D <sub>n</sub>	↑	D <sub>n</sub>

### Design Entry Method

This design element is only for use in schematics.

### For More Information

- See the [Spartan-3 User Guide](#).
- See the [Spartan-3 Data Sheets](#).

## OFDE8

Macro: 8-Bit D Flip-Flop with Active-High Enable Output Buffers

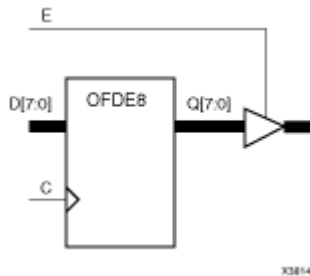

### Introduction

This is a multiple D flip-flop whose outputs are enabled by 3-state buffers. The flip-flop data outputs (Q) are connected to the inputs of output buffers (OBUFE). The OBUFE outputs (O) are connected to OPADs or IOPADs. The data on the data inputs (D) is loaded into the flip-flops during the Low-to-High clock (C) transition. When the active-High enable inputs (E) are High, the data on the flip-flop outputs (Q) appears on the OBUFE outputs (O). When (E) is Low, outputs are high impedance (Z state or Off).

This flip-flop is asynchronously cleared, outputs Low, when power is applied. For FPGA devices, power-on conditions are simulated when global set/reset (GSR) is active. GSR defaults to active-High but can be inverted by adding an inverter in front of the GSR input of the appropriate `STARTUP_architecture` symbol.

### Logic Table

Inputs			Outputs
E	D	C	O
0	X	X	Z
1	Dn	↑	Dn

### Design Entry Method

This design element is only for use in schematics.

### For More Information

- See the [Spartan-3 User Guide](#).
- See the [Spartan-3 Data Sheets](#).

## OFDI

Macro: Output D Flip-Flop (Asynchronous Preset)

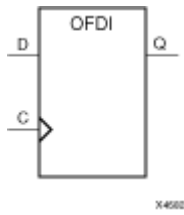

### Introduction

The design element is contained in an input/output block (IOB). The output (Q) of the (D) flip-flop is connected to an OPAD or an IOPAD. The data on the (D) input is loaded into the flip-flop during the Low-to-High clock (C) transition and appears at the output (Q).

This flip-flop is asynchronously preset, output High, when power is applied. For FPGA devices, power-on conditions are simulated when global set/reset (GSR) is active. GSR defaults to active-High but can be inverted by adding an inverter in front of the GSR input of the appropriate `STARTUP_architecture` symbol.

### Logic Table

Inputs		Outputs
D	C	Q
D	↑	D

### Design Entry Method

This design element is only for use in schematics.

### For More Information

- See the [Spartan-3 User Guide](#).
- See the [Spartan-3 Data Sheets](#).

## OFDI\_1

Macro: Output D Flip-Flop with Inverted Clock (Asynchronous Preset)

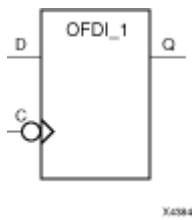

### Introduction

This design element exists in an input/output block (IOB). The (D) flip-flop output (Q) is connected to an OPAD or an IOPAD. The data on the (D) input is loaded into the flip-flop during the High-to-Low clock (C) transition and appears on the (Q) output.

This flip-flop is asynchronously preset, output High, when power is applied. For FPGA devices, power-on conditions are simulated when global set/reset (GSR) is active. GSR defaults to active-High but can be inverted by adding an inverter in front of the GSR input of the appropriate *STARTUP\_architecture* symbol.

### Logic Table

Inputs		Outputs
D	C	Q
D	↓	D

### Design Entry Method

This design element is only for use in schematics.

### For More Information

- See the [Spartan-3 User Guide](#).
- See the [Spartan-3 Data Sheets](#).



## OFDT

Macro: D Flip-Flop with Active-Low 3-State Output Buffer

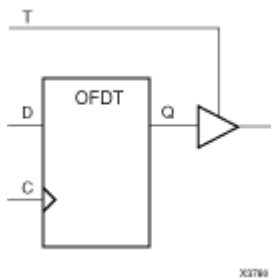

### Introduction

This design element is a single D flip-flops whose output is enabled by a 3-state buffer.

The data outputs (Q) of the flip-flops are connected to the inputs of output buffers (OBUFT). The outputs of the OBUFTs (O) are connected to OPADs or IOPADs. The data on the data inputs (D) is loaded into the flip-flops during the Low-to-High clock (C) transition. When the active-Low enable inputs (T) are Low, the data on the flip-flop outputs (Q) appears on the (O) outputs. When (T) is High, outputs are high impedance (Off).

This flip-flop is asynchronously cleared, outputs Low, when power is applied. For FPGA devices, power-on conditions are simulated when global set/reset (GSR) is active. GSR defaults to active-High but can be inverted by adding an inverter in front of the GSR input of the appropriate `STARTUP_architecture` symbol.

### Logic Table

Inputs			Outputs
T	D	C	O
1	X	X	Z
0	D	↑	D

### Design Entry Method

This design element is only for use in schematics.

### For More Information

- See the [Spartan-3 User Guide](#).
- See the [Spartan-3 Data Sheets](#).

## OFDT\_1

Macro: D Flip-Flop with Active-Low 3-State Output Buffer and Inverted Clock

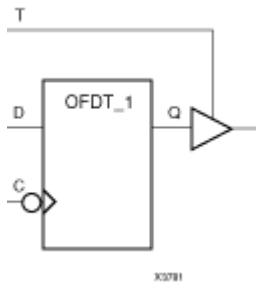

### Introduction

The design element and its output buffer are located in an input/output block (IOB). The flip-flop data output (Q) is connected to the input of an output buffer (OBUFT). The OBUFT output is connected to an OPAD or an IOPAD. The data on the data input (D) is loaded into the flip-flop on the High-to-Low clock (C) transition. When the active-Low enable input (T) is Low, the data on the flip-flop output (Q) appears on the (O) output. When (T) is High, the output is high impedance (Off).

This flip-flop is asynchronously cleared, outputs Low, when power is applied. For FPGA devices, power-on conditions are simulated when global set/reset (GSR) is active. GSR defaults to active-High but can be inverted by adding an inverter in front of the GSR input of the appropriate `STARTUP_architecture` symbol.

### Logic Table

Inputs			Outputs
T	D	C	O
1	X	X	Z
0	D	↓	D

### Design Entry Method

This design element is only for use in schematics.

### For More Information

- See the [Spartan-3 User Guide](#).
- See the [Spartan-3 Data Sheets](#).

## OFDT16

Macro: 16-Bit D Flip-Flop with Active-Low 3-State Output Buffers

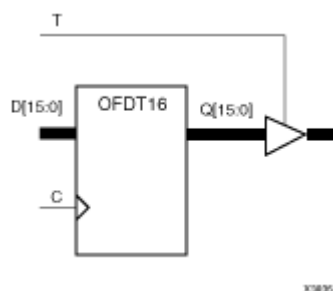

### Introduction

This design element is a multiple D flip-flop whose output are enabled by 3-state buffers.

The data outputs (Q) of the flip-flops are connected to the inputs of output buffers (OBUFT). The outputs of the OBUFTs (O) are connected to OPADs or IOPADs. The data on the data inputs (D) is loaded into the flip-flops during the Low-to-High clock (C) transition. When the active-Low enable inputs (T) are Low, the data on the flip-flop outputs (Q) appears on the (O) outputs. When (T) is High, outputs are high impedance (Off).

This flip-flop is asynchronously cleared, outputs Low, when power is applied. For FPGA devices, power-on conditions are simulated when global set/reset (GSR) is active. GSR defaults to active-High but can be inverted by adding an inverter in front of the GSR input of the appropriate `STARTUP_architecture` symbol.

### Logic Table

Inputs			Outputs
T	D	C	O
1	X	X	Z
0	D	↑	D

### Design Entry Method

This design element is only for use in schematics.

### For More Information

- See the [Spartan-3 User Guide](#).
- See the [Spartan-3 Data Sheets](#).

## OFDT4

Macro: 4-Bit D Flip-Flop with Active-Low 3-State Output Buffers

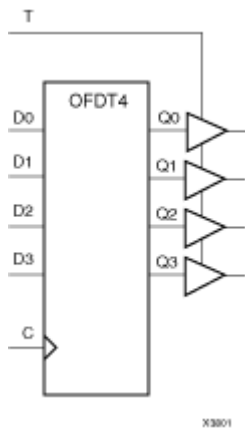

### Introduction

This design element is a multiple D flip-flop whose output are enabled by 3-state buffers.

The data outputs (Q) of the flip-flops are connected to the inputs of output buffers (OBUFT). The outputs of the OBUFTs (O) are connected to OPADs or IOPADs. The data on the data inputs (D) is loaded into the flip-flops during the Low-to-High clock (C) transition. When the active-Low enable inputs (T) are Low, the data on the flip-flop outputs (Q) appears on the (O) outputs. When (T) is High, outputs are high impedance (Off).

This flip-flop is asynchronously cleared, outputs Low, when power is applied. For FPGA devices, power-on conditions are simulated when global set/reset (GSR) is active. GSR defaults to active-High but can be inverted by adding an inverter in front of the GSR input of the appropriate `STARTUP_architecture` symbol.

### Logic Table

Inputs			Outputs
T	D	C	O
1	X	X	Z
0	D	↑	D

### Design Entry Method

This design element is only for use in schematics.

### For More Information

- See the [Spartan-3 User Guide](#).
- See the [Spartan-3 Data Sheets](#).

## OFDT8

Macro: 8-Bit D Flip-Flop with Active-Low 3-State Output Buffers

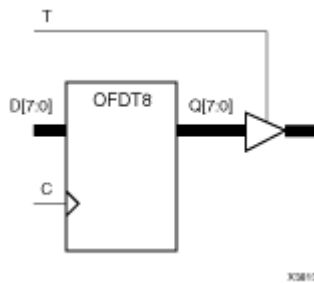

### Introduction

This design element is a multiple D flip-flop whose output are enabled by 3-state buffers.

The data outputs (Q) of the flip-flops are connected to the inputs of output buffers (OBUFT). The outputs of the OBUFTs (O) are connected to OPADs or IOPADs. The data on the data inputs (D) is loaded into the flip-flops during the Low-to-High clock (C) transition. When the active-Low enable inputs (T) are Low, the data on the flip-flop outputs (Q) appears on the (O) outputs. When (T) is High, outputs are high impedance (Off).

This flip-flop is asynchronously cleared, outputs Low, when power is applied. For FPGA devices, power-on conditions are simulated when global set/reset (GSR) is active. GSR defaults to active-High but can be inverted by adding an inverter in front of the GSR input of the appropriate `STARTUP_architecture` symbol.

### Logic Table

Inputs			Outputs
T	D	C	O
1	X	X	Z
0	D	↑	D

### Design Entry Method

This design element is only for use in schematics.

### For More Information

- See the [Spartan-3 User Guide](#).
- See the [Spartan-3 Data Sheets](#).

## OFDX

Macro: Output D Flip-Flop with Clock Enable

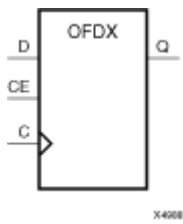

### Introduction

This design element is a single output D flip-flop. The (Q) output is connected to OPAD or IOPAD. The data on the (D) input is loaded into the flip-flop during the Low-to-High clock (C) transition and appears on the (Q) output. When (CE) is Low, the flip-flop output does not change.

This flip-flop is asynchronously cleared, outputs Low, when power is applied. For FPGA devices, power-on conditions are simulated when global set/reset (GSR) is active. GSR defaults to active-High but can be inverted by adding an inverter in front of the GSR input of the appropriate *STARTUP\_architecture* symbol.

### Logic Table

Inputs			Outputs
CE	D	C	Q
1	Dn	↑	Dn
0	X	X	No change

### Design Entry Method

This design element is only for use in schematics.

### For More Information

- See the [Spartan-3 User Guide](#).
- See the [Spartan-3 Data Sheets](#).

## OFDX\_1

Macro: Output D Flip-Flop with Inverted Clock and Clock Enable

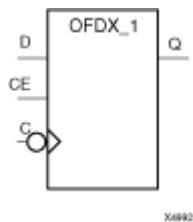

### Introduction

The design element is located in an input/output block (IOB). The output (Q) of the (D) flip-flop is connected to an OPAD or an IOPAD. The data on the (D) input is loaded into the flip-flop during the High-to-Low clock (C) transition and appears on the (Q) output. When the (CE) pin is Low, the output (Q) does not change.

This flip-flop is asynchronously cleared, outputs Low, when power is applied. For FPGA devices, power-on conditions are simulated when global set/reset (GSR) is active. GSR defaults to active-High but can be inverted by adding an inverter in front of the GSR input of the appropriate *STARTUP\_architecture* symbol.

### Logic Table

Inputs			Outputs
CE	D	C	Q
1	D	↓	D
0	X	X	No Change

### Design Entry Method

This design element is only for use in schematics.

### For More Information

- See the [Spartan-3 User Guide](#).
- See the [Spartan-3 Data Sheets](#).

## OFDX16

Macro: 16-Bit Output D Flip-Flop with Clock Enable

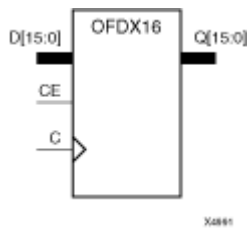

### Introduction

This design element is a multiple output D flip-flop. The (Q) output is connected to OPAD or IOPAD. The data on the (D) input is loaded into the flip-flop during the Low-to-High clock (C) transition and appears on the (Q) output. When (CE) is Low, the flip-flop output does not change.

This flip-flop is asynchronously cleared, outputs Low, when power is applied. For FPGA devices, power-on conditions are simulated when global set/reset (GSR) is active. GSR defaults to active-High but can be inverted by adding an inverter in front of the GSR input of the appropriate `STARTUP_architecture` symbol.

### Logic Table

Inputs			Outputs
CE	D	C	Q
1	Dn	↑	Dn
0	X	X	No change

### Design Entry Method

This design element is only for use in schematics.

### For More Information

- See the [Spartan-3 User Guide](#).
- See the [Spartan-3 Data Sheets](#).



# OFDX4

Macro: 4-Bit Output D Flip-Flop with Clock Enable

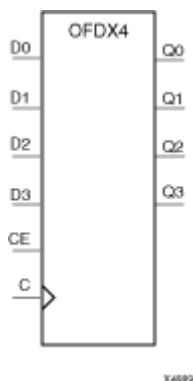

## Introduction

This design element is a multiple output D flip-flop. The (Q) output is connected to OPAD or IOPAD. The data on the (D) input is loaded into the flip-flop during the Low-to-High clock (C) transition and appears on the (Q) output. When (CE) is Low, the flip-flop output does not change.

This flip-flop is asynchronously cleared, outputs Low, when power is applied. For FPGA devices, power-on conditions are simulated when global set/reset (GSR) is active. GSR defaults to active-High but can be inverted by adding an inverter in front of the GSR input of the appropriate `STARTUP_architecture` symbol.

## Logic Table

Inputs			Outputs
CE	D	C	Q
1	Dn	↑	Dn
0	X	X	No change

## Design Entry Method

This design element is only for use in schematics.

## For More Information

- See the [Spartan-3 User Guide](#).
- See the [Spartan-3 Data Sheets](#).

## OFDX8

Macro: 8-Bit Output D Flip-Flop with Clock Enable

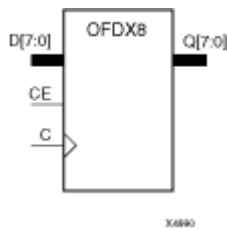

### Introduction

This design element is a multiple output D flip-flop. The (Q) output is connected to OPAD or IOPAD. The data on the (D) input is loaded into the flip-flop during the Low-to-High clock (C) transition and appears on the (Q) output. When (CE) is Low, the flip-flop output does not change.

This flip-flop is asynchronously cleared, outputs Low, when power is applied. For FPGA devices, power-on conditions are simulated when global set/reset (GSR) is active. GSR defaults to active-High but can be inverted by adding an inverter in front of the GSR input of the appropriate *STARTUP\_architecture* symbol.

### Logic Table

Inputs			Outputs
CE	D	C	Q
1	Dn	↑	Dn
0	X	X	No change

### Design Entry Method

This design element is only for use in schematics.

### For More Information

- See the [Spartan-3 User Guide](#).
- See the [Spartan-3 Data Sheets](#).

## OFDXI

Macro: Output D Flip-Flop with Clock Enable (Asynchronous Preset)

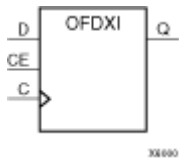

### Introduction

The design element is contained in an input/output block (IOB). The output (Q) of the D flip-flop is connected to an OPAD or an IOPAD. The data on the (D) input is loaded into the flip-flop during the Low-to-High clock (C) transition and appears at the output (Q). When (CE) is Low, the output does not change

This flip-flop is asynchronously preset, output High, when power is applied. For FPGA devices, power-on conditions are simulated when global set/reset (GSR) is active. GSR defaults to active-High but can be inverted by adding an inverter in front of the GSR input of the appropriate `STARTUP_architecture` symbol.

### Logic Table

Inputs			Outputs
CE	D	C	Q
1	D	↑	D
0	X	X	No Change

### Design Entry Method

This design element is only for use in schematics.

### For More Information

- See the [Spartan-3 User Guide](#).
- See the [Spartan-3 Data Sheets](#).

## OFDXI\_1

Macro: Output D Flip-Flop with Inverted Clock and Clock Enable (Asynchronous Preset)

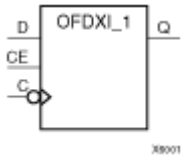

### Introduction

The design element is located in an input/output block (IOB). The D flip-flop output (Q) is connected to an OPAD or an IOPAD. The data on the D input is loaded into the flip-flop during the High-to-Low clock (C) transition and appears on the Q output. When CE is Low, the output (Q) does not change.

This flip-flop is asynchronously preset, output High, when power is applied. For FPGA devices, power-on conditions are simulated when global set/reset (GSR) is active. GSR defaults to active-High but can be inverted by adding an inverter in front of the GSR input of the appropriate `STARTUP_architecture` symbol.

### Logic Table

Inputs			Outputs
CE	D	C	Q
1	D	↓	D
0	X	X	No Change

### Design Entry Method

This design element is only for use in schematics.

### For More Information

- See the [Spartan-3 User Guide](#).
- See the [Spartan-3 Data Sheets](#).

## OR12

Macro: 12-Input OR Gate with Non-Inverted Inputs

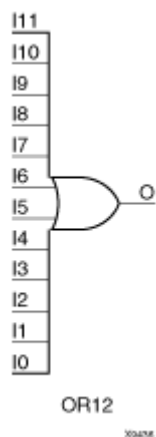

### Introduction

OR functions of up to five inputs are available in any combination of inverting and non-inverting inputs. OR functions of six to nine inputs, 12 inputs, and 16 inputs are available with only non-inverting inputs. To invert some or all inputs, use external inverters. Because each input uses a CLB resource, replace functions with unused inputs with functions having the necessary number of inputs.

### Design Entry Method

This design element is only for use in schematics.

### For More Information

- See the [Spartan-3 User Guide](#).
- See the [Spartan-3 Data Sheets](#).

## OR16

Macro: 16-Input OR Gate with Non-Inverted Inputs

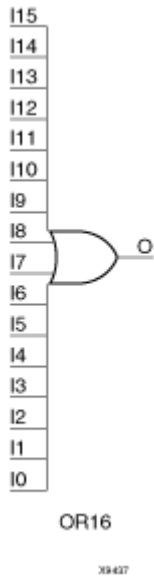

### Introduction

OR functions of up to five inputs are available in any combination of inverting and non-inverting inputs. OR functions of six to nine inputs, 12 inputs, and 16 inputs are available with only non-inverting inputs. To invert some or all inputs, use external inverters. Because each input uses a CLB resource, replace functions with unused inputs with functions having the necessary number of inputs.

### Design Entry Method

This design element is only for use in schematics.

### For More Information

- See the [Spartan-3 User Guide](#).
- See the [Spartan-3 Data Sheets](#).

## OR2

Primitive: 2-Input OR Gate with Non-Inverted Inputs

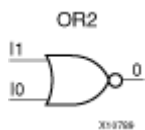

### Introduction

OR functions of up to five inputs are available in any combination of inverting and non-inverting inputs. OR functions of six to nine inputs, 12 inputs, and 16 inputs are available with only non-inverting inputs. To invert some or all inputs, use external inverters. Because each input uses a CLB resource, replace functions with unused inputs with functions having the necessary number of inputs.

### Design Entry Method

This design element is only for use in schematics.

### For More Information

- See the [Spartan-3 User Guide](#).
- See the [Spartan-3 Data Sheets](#).

## OR2B1

Primitive: 2-Input OR Gate with 1 Inverted and 1 Non-Inverted Inputs

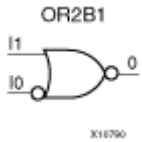

### Introduction

OR functions of up to five inputs are available in any combination of inverting and non-inverting inputs. OR functions of six to nine inputs, 12 inputs, and 16 inputs are available with only non-inverting inputs. To invert some or all inputs, use external inverters. Because each input uses a CLB resource, replace functions with unused inputs with functions having the necessary number of inputs.

### Design Entry Method

This design element is only for use in schematics.

### For More Information

- See the [Spartan-3 User Guide](#).
- See the [Spartan-3 Data Sheets](#).



## OR2B2

Primitive: 2-Input OR Gate with Inverted Inputs

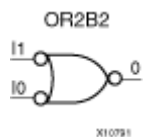

### Introduction

OR functions of up to five inputs are available in any combination of inverting and non-inverting inputs. OR functions of six to nine inputs, 12 inputs, and 16 inputs are available with only non-inverting inputs. To invert some or all inputs, use external inverters. Because each input uses a CLB resource, replace functions with unused inputs with functions having the necessary number of inputs.

### Design Entry Method

This design element is only for use in schematics.

### For More Information

- See the [Spartan-3 User Guide](#).
- See the [Spartan-3 Data Sheets](#).

## OR3

Primitive: 3-Input OR Gate with Non-Inverted Inputs

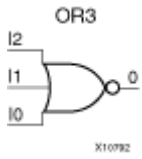

### Introduction

OR functions of up to five inputs are available in any combination of inverting and non-inverting inputs. OR functions of six to nine inputs, 12 inputs, and 16 inputs are available with only non-inverting inputs. To invert some or all inputs, use external inverters. Because each input uses a CLB resource, replace functions with unused inputs with functions having the necessary number of inputs.

### Design Entry Method

This design element is only for use in schematics.

### For More Information

- See the [Spartan-3 User Guide](#).
- See the [Spartan-3 Data Sheets](#).

## OR3B1

Primitive: 3-Input OR Gate with 1 Inverted and 2 Non-Inverted Inputs

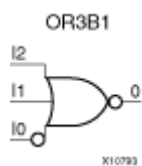

### Introduction

OR functions of up to five inputs are available in any combination of inverting and non-inverting inputs. OR functions of six to nine inputs, 12 inputs, and 16 inputs are available with only non-inverting inputs. To invert some or all inputs, use external inverters. Because each input uses a CLB resource, replace functions with unused inputs with functions having the necessary number of inputs.

### Design Entry Method

This design element is only for use in schematics.

### For More Information

- See the [Spartan-3 User Guide](#).
- See the [Spartan-3 Data Sheets](#).

## OR3B2

Primitive: 3-Input OR Gate with 2 Inverted and 1 Non-Inverted Inputs

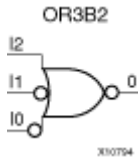

### Introduction

OR functions of up to five inputs are available in any combination of inverting and non-inverting inputs. OR functions of six to nine inputs, 12 inputs, and 16 inputs are available with only non-inverting inputs. To invert some or all inputs, use external inverters. Because each input uses a CLB resource, replace functions with unused inputs with functions having the necessary number of inputs.

### Design Entry Method

This design element is only for use in schematics.

### For More Information

- See the [Spartan-3 User Guide](#).
- See the [Spartan-3 Data Sheets](#).

## OR3B3

Primitive: 3-Input OR Gate with Inverted Inputs

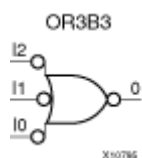

### Introduction

OR functions of up to five inputs are available in any combination of inverting and non-inverting inputs. OR functions of six to nine inputs, 12 inputs, and 16 inputs are available with only non-inverting inputs. To invert some or all inputs, use external inverters. Because each input uses a CLB resource, replace functions with unused inputs with functions having the necessary number of inputs.

### Design Entry Method

This design element is only for use in schematics.

### For More Information

- See the [Spartan-3 User Guide](#).
- See the [Spartan-3 Data Sheets](#).

## OR4

Primitive: 4-Input OR Gate with Non-Inverted Inputs

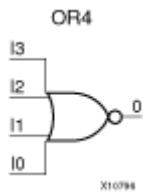

### Introduction

OR functions of up to five inputs are available in any combination of inverting and non-inverting inputs. OR functions of six to nine inputs, 12 inputs, and 16 inputs are available with only non-inverting inputs. To invert some or all inputs, use external inverters. Because each input uses a CLB resource, replace functions with unused inputs with functions having the necessary number of inputs.

### Design Entry Method

This design element is only for use in schematics.

### For More Information

- See the [Spartan-3 User Guide](#).
- See the [Spartan-3 Data Sheets](#).

## OR4B1

Primitive: 4-Input OR Gate with 1 Inverted and 3 Non-Inverted Inputs

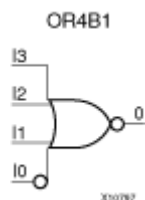

### Introduction

OR functions of up to five inputs are available in any combination of inverting and non-inverting inputs. OR functions of six to nine inputs, 12 inputs, and 16 inputs are available with only non-inverting inputs. To invert some or all inputs, use external inverters. Because each input uses a CLB resource, replace functions with unused inputs with functions having the necessary number of inputs.

### Design Entry Method

This design element is only for use in schematics.

### For More Information

- See the [Spartan-3 User Guide](#).
- See the [Spartan-3 Data Sheets](#).

## OR4B2

Primitive: 4-Input OR Gate with 2 Inverted and 2 Non-Inverted Inputs

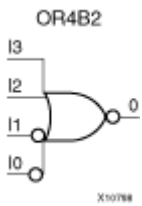

### Introduction

OR functions of up to five inputs are available in any combination of inverting and non-inverting inputs. OR functions of six to nine inputs, 12 inputs, and 16 inputs are available with only non-inverting inputs. To invert some or all inputs, use external inverters. Because each input uses a CLB resource, replace functions with unused inputs with functions having the necessary number of inputs.

### Design Entry Method

This design element is only for use in schematics.

### For More Information

- See the [Spartan-3 User Guide](#).
- See the [Spartan-3 Data Sheets](#).



## OR4B3

Primitive: 4-Input OR Gate with 3 Inverted and 1 Non-Inverted Inputs

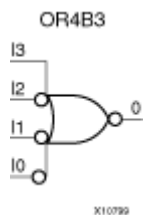

### Introduction

OR functions of up to five inputs are available in any combination of inverting and non-inverting inputs. OR functions of six to nine inputs, 12 inputs, and 16 inputs are available with only non-inverting inputs. To invert some or all inputs, use external inverters. Because each input uses a CLB resource, replace functions with unused inputs with functions having the necessary number of inputs.

### Design Entry Method

This design element is only for use in schematics.

### For More Information

- See the [Spartan-3 User Guide](#).
- See the [Spartan-3 Data Sheets](#).

## OR4B4

Primitive: 4-Input OR Gate with Inverted Inputs

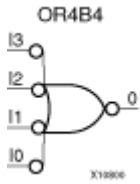

### Introduction

OR functions of up to five inputs are available in any combination of inverting and non-inverting inputs. OR functions of six to nine inputs, 12 inputs, and 16 inputs are available with only non-inverting inputs. To invert some or all inputs, use external inverters. Because each input uses a CLB resource, replace functions with unused inputs with functions having the necessary number of inputs.

### Design Entry Method

This design element is only for use in schematics.

### For More Information

- See the [Spartan-3 User Guide](#).
- See the [Spartan-3 Data Sheets](#).

## OR5

Primitive: 5-Input OR Gate with Non-Inverted Inputs

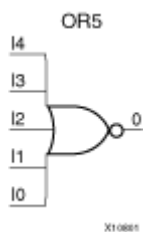

### Introduction

OR functions of up to five inputs are available in any combination of inverting and non-inverting inputs. OR functions of six to nine inputs, 12 inputs, and 16 inputs are available with only non-inverting inputs. To invert some or all inputs, use external inverters. Because each input uses a CLB resource, replace functions with unused inputs with functions having the necessary number of inputs.

### Design Entry Method

This design element is only for use in schematics.

### For More Information

- See the [Spartan-3 User Guide](#).
- See the [Spartan-3 Data Sheets](#).

## OR5B1

Primitive: 5-Input OR Gate with 1 Inverted and 4 Non-Inverted Inputs

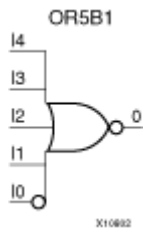

### Introduction

OR functions of up to five inputs are available in any combination of inverting and non-inverting inputs. OR functions of six to nine inputs, 12 inputs, and 16 inputs are available with only non-inverting inputs. To invert some or all inputs, use external inverters. Because each input uses a CLB resource, replace functions with unused inputs with functions having the necessary number of inputs.

### Design Entry Method

This design element is only for use in schematics.

### For More Information

- See the [Spartan-3 User Guide](#).
- See the [Spartan-3 Data Sheets](#).

## OR5B2

Primitive: 5-Input OR Gate with 2 Inverted and 3 Non-Inverted Inputs

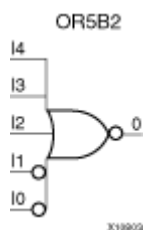

### Introduction

OR functions of up to five inputs are available in any combination of inverting and non-inverting inputs. OR functions of six to nine inputs, 12 inputs, and 16 inputs are available with only non-inverting inputs. To invert some or all inputs, use external inverters. Because each input uses a CLB resource, replace functions with unused inputs with functions having the necessary number of inputs.

### Design Entry Method

This design element is only for use in schematics.

### For More Information

- See the [Spartan-3 User Guide](#).
- See the [Spartan-3 Data Sheets](#).

## OR5B3

Primitive: 5-Input OR Gate with 3 Inverted and 2 Non-Inverted Inputs

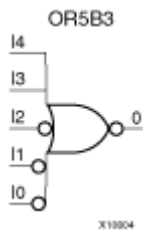

### Introduction

OR functions of up to five inputs are available in any combination of inverting and non-inverting inputs. OR functions of six to nine inputs, 12 inputs, and 16 inputs are available with only non-inverting inputs. To invert some or all inputs, use external inverters. Because each input uses a CLB resource, replace functions with unused inputs with functions having the necessary number of inputs.

### Design Entry Method

This design element is only for use in schematics.

### For More Information

- See the [Spartan-3 User Guide](#).
- See the [Spartan-3 Data Sheets](#).

## OR5B4

Primitive: 5-Input OR Gate with 4 Inverted and 1 Non-Inverted Inputs

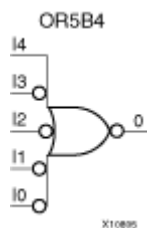

### Introduction

OR functions of up to five inputs are available in any combination of inverting and non-inverting inputs. OR functions of six to nine inputs, 12 inputs, and 16 inputs are available with only non-inverting inputs. To invert some or all inputs, use external inverters. Because each input uses a CLB resource, replace functions with unused inputs with functions having the necessary number of inputs.

### Design Entry Method

This design element is only for use in schematics.

### For More Information

- See the [Spartan-3 User Guide](#).
- See the [Spartan-3 Data Sheets](#).

## OR5B5

Primitive: 5-Input OR Gate with Inverted Inputs

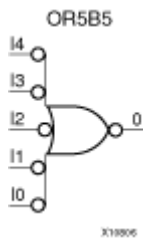

### Introduction

OR functions of up to five inputs are available in any combination of inverting and non-inverting inputs. OR functions of six to nine inputs, 12 inputs, and 16 inputs are available with only non-inverting inputs. To invert some or all inputs, use external inverters. Because each input uses a CLB resource, replace functions with unused inputs with functions having the necessary number of inputs.

### Design Entry Method

This design element is only for use in schematics.

### For More Information

- See the [Spartan-3 User Guide](#).
- See the [Spartan-3 Data Sheets](#).



## OR6

Macro: 6-Input OR Gate with Non-Inverted Inputs

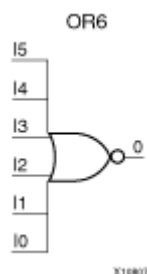

### Introduction

OR functions of up to five inputs are available in any combination of inverting and non-inverting inputs. OR functions of six to nine inputs, 12 inputs, and 16 inputs are available with only non-inverting inputs. To invert some or all inputs, use external inverters. Because each input uses a CLB resource, replace functions with unused inputs with functions having the necessary number of inputs.

### Design Entry Method

This design element is only for use in schematics.

### For More Information

- See the [Spartan-3 User Guide](#).
- See the [Spartan-3 Data Sheets](#).

## OR7

Macro: 7-Input OR Gate with Non-Inverted Inputs

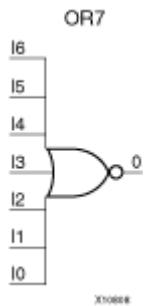

### Introduction

OR functions of up to five inputs are available in any combination of inverting and non-inverting inputs. OR functions of six to nine inputs, 12 inputs, and 16 inputs are available with only non-inverting inputs. To invert some or all inputs, use external inverters. Because each input uses a CLB resource, replace functions with unused inputs with functions having the necessary number of inputs.

### Design Entry Method

This design element is only for use in schematics.

### For More Information

- See the [Spartan-3 User Guide](#).
- See the [Spartan-3 Data Sheets](#).

## OR8

Macro: 8-Input OR Gate with Non-Inverted Inputs

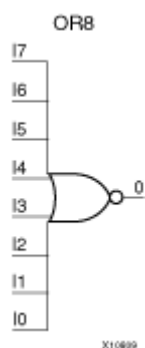

### Introduction

OR functions of up to five inputs are available in any combination of inverting and non-inverting inputs. OR functions of six to nine inputs, 12 inputs, and 16 inputs are available with only non-inverting inputs. To invert some or all inputs, use external inverters. Because each input uses a CLB resource, replace functions with unused inputs with functions having the necessary number of inputs.

### Design Entry Method

This design element is only for use in schematics.

### For More Information

- See the [Spartan-3 User Guide](#).
- See the [Spartan-3 Data Sheets](#).

## OR9

Macro: 9-Input OR Gate with Non-Inverted Inputs

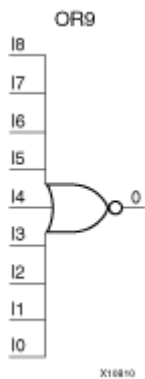

### Introduction

OR functions of up to five inputs are available in any combination of inverting and non-inverting inputs. OR functions of six to nine inputs, 12 inputs, and 16 inputs are available with only non-inverting inputs. To invert some or all inputs, use external inverters. Because each input uses a CLB resource, replace functions with unused inputs with functions having the necessary number of inputs.

### Design Entry Method

This design element is only for use in schematics.

### For More Information

- See the [Spartan-3 User Guide](#).
- See the [Spartan-3 Data Sheets](#).

## PULLDOWN

Primitive: Resistor to GND for Input Pads, Open-Drain, and 3-State Outputs

PULLDOWN



### Introduction

This resistor element is connected to input, output, or bidirectional pads to guarantee a logic Low level for nodes that might float.

### Port Descriptions

Name	Direction	Width	Function
O	Output	1-Bit	Pulldown output (connect directly to top level port)

### Design Entry Method

This design element can be used in schematics.

This element can be connected to a net in the following locations on a top-level schematic file:

- A net connected to an input IO Marker
- A net connected to both an output IO Marker and 3-statable IO element, such as an OBUFT.

### For More Information

- See the [Spartan-3 User Guide](#).
- See the [Spartan-3 Data Sheets](#).

# PULLUP

Primitive: Resistor to VCC for Input PADS, Open-Drain, and 3-State Outputs



## Introduction

This design element allows for an input, 3-state output or bi-directional port to be driven to a weak high value when not being driven by an internal or external source. This element establishes a High logic level for open-drain elements and macros when all the drivers are off.

## Port Descriptions

Name	Direction	Width	Function
O	Output	1-Bit	Pullup output (connect directly to top level port)

## Design Entry Method

This design element can be used in schematics.

This element can be connected to a net in the following locations on a top-level schematic file:

- A net connected to an input IO Marker
- A net connected to both an output IO Marker and 3-statable IO element, such as an OBUFT.

## For More Information

- See the [Spartan-3 User Guide](#).
- See the [Spartan-3 Data Sheets](#).

# RAM16X1D

Primitive: 16-Deep by 1-Wide Static Dual Port Synchronous RAM

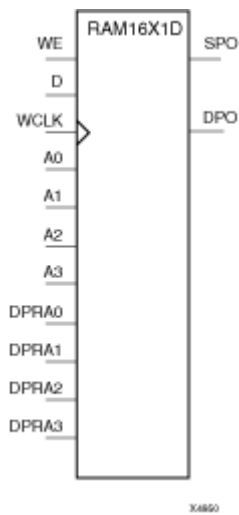

## Introduction

This element is a 16-word by 1-bit static dual port random access memory with synchronous write capability. The device has two address ports: the read address (DPRA3 – DPRA0) and the write address (A3 – A0). These two address ports are asynchronous. The read address controls the location of the data driven out of the output pin (DPO), and the write address controls the destination of a valid write transaction. When the write enable (WE) is Low, transitions on the write clock (WCLK) are ignored and data stored in the RAM is not affected.

When WE is High, any positive transition on (WCLK) loads the data on the data input (D) into the word selected by the 4-bit write address. For predictable performance, write address and data inputs must be stable before a Low-to-High (WCLK) transition. This RAM block assumes an active-High (WCLK). (WCLK) can be active-High or active-Low. Any inverter placed on the (WCLK) input net is absorbed into the block.

The SPO output reflects the data in the memory cell addressed by A3 – A0. The DPO output reflects the data in the memory cell addressed by DPRA3 – DPRA0.

**Note** The write process is not affected by the address on the read address port.

You can use the INIT attribute to directly specify an initial value. The value must be a hexadecimal number, for example, INIT=ABAC. If the INIT attribute is not specified, the RAM is initialized with all zeros.

## Logic Table

Mode selection is shown in the following logic table:

Inputs			Outputs	
WE (mode)	WCLK	D	SPO	DPO
0 (read)	X	X	data_a	data_d
1 (read)	0	X	data_a	data_d
1 (read)	1	X	data_a	data_d
1 (write)	↑	D	D	data_d

Inputs			Outputs	
<b>WE (mode)</b>	<b>WCLK</b>	<b>D</b>	<b>SPO</b>	<b>DPO</b>
1 (read)	↓	X	data_a	data_d
data_a = word addressed by bits A3-A0 data_d = word addressed by bits DPRA3-DPRA0				

## Design Entry Method

This design element can be used in schematics.

## Available Attributes

Attribute	Type	Allowed Values	Default	Description
INIT	Hexadecimal	Any 16-Bit Value	All zeros.	Initializes RAMs, registers, and look-up tables.

## For More Information

- See the [Spartan-3 User Guide](#).
- See the [Spartan-3 Data Sheets](#).



## RAM16X1D\_1

Primitive: 16-Deep by 1-Wide Static Dual Port Synchronous RAM with Negative-Edge Clock

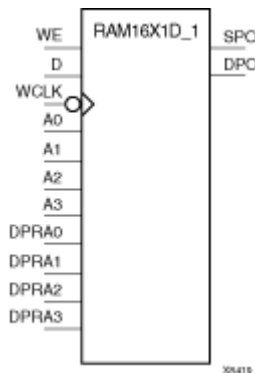

### Introduction

This is a 16-word by 1-bit static dual port random access memory with synchronous write capability and negative-edge clock. The device has two separate address ports: the read address (DPRA3 – DPRA0) and the write address (A3 – A0). These two address ports are asynchronous. The read address controls the location of the data driven out of the output pin (DPO), and the write address controls the destination of a valid write transaction.

When the write enable (WE) is set to Low, transitions on the write clock (WCLK) are ignored and data stored in the RAM is not affected. When (WE) is High, any negative transition on (WCLK) loads the data on the data input (D) into the word selected by the 4-bit write address. For predictable performance, write address and data inputs must be stable before a High-to-Low WCLK transition. This RAM block assumes an active-High (WCLK). (WCLK) can be active-High or active-Low. Any inverter placed on the (WCLK) input net is absorbed into the block.

You can initialize RAM16X1D\_1 during configuration using the INIT attribute.

The SPO output reflects the data in the memory cell addressed by A3 – A0. The DPO output reflects the data in the memory cell addressed by DPRA3 – DPRA0.

**Note** The write process is not affected by the address on the read address port.

### Logic Table

Mode selection is shown in the following logic table:

Inputs			Outputs	
WE (mode)	WCLK	D	SPO	DPO
0 (read)	X	X	data_a	data_d
1 (read)	0	X	data_a	data_d
1 (read)	1	X	data_a	data_d
1 (write)	↓	D	D	data_d
1 (read)	↑	X	data_a	data_d

data\_a = word addressed by bits A3 – A0

data\_d = word addressed by bits DPRA3-DPRA0

## Port Descriptions

Name	Direction	Width	Function
DPO	Output	1-Bit	Read-only 1-Bit data output
SPO	Output	1-Bit	R/W 1-Bit data output
A0	Input	1-Bit	R/W address[0] input
A1	Input	1-Bit	R/W address[1] input
A2	Input	1-Bit	R/W address[2] input
A3	Input	1-Bit	R/W address[3] input
D	Input	1-Bit	Write 1-Bit data input
DPRA0	Input	1-Bit	Read-only address[0] input
DPRA1	Input	1-Bit	Read-only address[1] input
DPRA2	Input	1-Bit	Read-only address[2] input
DPRA3	Input	1-Bit	Read-only address[3] input
WCLK	Input	1-Bit	Write clock input
WE	Input	1-Bit	Write enable input

## Design Entry Method

This design element can be used in schematics.

## Available Attributes

Attribute	Type	Allowed Values	Default	Description
INIT	Hexadecimal	Any 16-Bit Value	All zeros	Initializes RAMs, registers, and look-up tables.

## For More Information

- See the [Spartan-3 User Guide](#).
- See the [Spartan-3 Data Sheets](#).

## RAM16X1S

Primitive: 16-Deep by 1-Wide Static Synchronous RAM

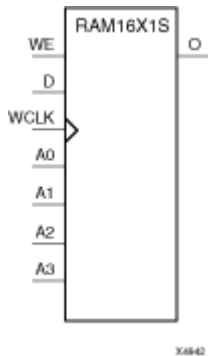

### Introduction

This element is a 16-word by 1-bit static random access memory with synchronous write capability. When the write enable (WE) is set Low, transitions on the write clock (WCLK) are ignored and data stored in the RAM is not affected. When WE is set High, any positive transition on WCLK loads the data on the data input (D) into the word selected by the 4-bit address (A3 – A0). This RAM block assumes an active-High WCLK. However, WCLK can be active-High or active-Low. Any inverter placed on the WCLK input net is absorbed into the block.

The signal output on the data output pin (O) is the data that is stored in the RAM at the location defined by the values on the address pins. You can initialize RAM16X1S during configuration using the INIT attribute.

### Logic Table

Inputs			Outputs
WE(mode)	WCLK	D	O
0 (read)	X	X	Data
1 (read)	0	X	Data
1 (read)	1	X	Data
1 (write)	↑	D	D
1 (read)	↓	X	Data

Data = word addressed by bits A3 – A0

### Design Entry Method

This design element can be used in schematics.

### Available Attributes

Attribute	Type	Allowed Values	Default	Description
INIT	Hexadecimal	Any 16-Bit Value	All zeros	Specifies initial contents of the RAM.

### For More Information

- See the [Spartan-3 User Guide](#).
- See the [Spartan-3 Data Sheets](#).

## RAM16X1S\_1

Primitive: 16-Deep by 1-Wide Static Synchronous RAM with Negative-Edge Clock

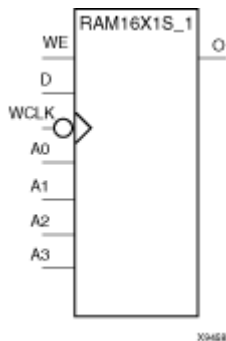

### Introduction

This element is a 16-word by 1-bit static random access memory with synchronous write capability and negative-edge clock. When the write enable (WE) is Low, transitions on the write clock (WCLK) are ignored and data stored in the RAM is not affected. When (WE) is High, any negative transition on (WCLK) loads the data on the data input (D) into the word selected by the 4-bit address (A3 – A0). For predictable performance, address and data inputs must be stable before a High-to-Low WCLK transition. This RAM block assumes an active-Low (WCLK). However, (WCLK) can be active-High or active-Low. Any inverter placed on the (WCLK) input net is absorbed into the block.

The signal output on the data output pin (O) is the data that is stored in the RAM at the location defined by the values on the address pins.

You can initialize this element during configuration using the INIT attribute.

### Logic Table

Inputs			Outputs
WE(mode)	WCLK	D	O
0 (read)	X	X	Data
1 (read)	0	X	Data
1 (read)	1	X	Data
1 (write)	↓	D	D
1 (read)	↑	X	Data

Data = word addressed by bits A3 – A0

### Design Entry Method

This design element can be used in schematics.

### Available Attributes

Attribute	Type	Allowed Values	Default	Description
INIT	Hexadecimal	Any 16-Bit Value	All zeros	Specifies initial contents of the RAM.

---

## For More Information

- See the [Spartan-3 User Guide](#).
- See the [Spartan-3 Data Sheets](#).

## RAM16X2S

Primitive: 16-Deep by 2-Wide Static Synchronous RAM

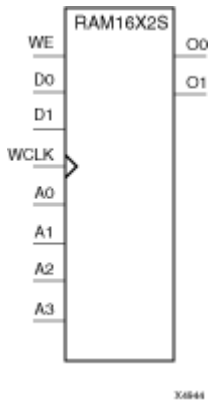

### Introduction

This element is a 16-word by 2-bit static random access memory with synchronous write capability. When the write enable (WE) is Low, transitions on the write clock (WCLK) are ignored and data stored in the RAM is not affected. When WE is High, any positive transition on WCLK loads the data on the data input (D1 – D0) into the word selected by the 4-bit address (A3 – A0). For predictable performance, address and data inputs must be stable before a Low-to-High WCLK transition. This RAM block assumes an active-High WCLK. However, WCLK can be active-High or active-Low. Any inverter placed on the WCLK input net is absorbed into the block.

The signal output on the data output pins (O1 – O0) is the data that is stored in the RAM at the location defined by the values on the address pins.

You can use the INIT\_xx properties to specify the initial contents of a Virtex-4 wide RAM. INIT\_00 initializes the RAM cells corresponding to the O0 output, INIT\_01 initializes the cells corresponding to the O1 output, etc. For example, a RAM16X2S instance is initialized by INIT\_00 and INIT\_01 containing 4 hex characters each. A RAM16X8S instance is initialized by eight properties INIT\_00 through INIT\_07 containing 4 hex characters each. A RAM64x2S instance is completely initialized by two properties INIT\_00 and INIT\_01 containing 16 hex characters each.

Except for Virtex-4 devices, the initial contents of this element cannot be specified directly.

### Logic Table

Inputs			Outputs
WE (mode)	WCLK	D1-D0	O1-O0
0 (read)	X	X	Data
1 (read)	0	X	Data
1 (read)	1	X	Data
1 (write)	↑	D1-D0	D1-D0
1 (read)	↓	X	Data
Data = word addressed by bits A3 – A0			

### Design Entry Method

This design element can be used in schematics.

## Available Attributes

Attribute	Type	Allowed Values	Default	Description
INIT_00 to INIT_01	Hexadecimal	Any 16-Bit Value	All zeros	Initializes RAMs, registers, and look-up tables.

## For More Information

- See the [Spartan-3 User Guide](#).
- See the [Spartan-3 Data Sheets](#).

## RAM16X4S

Primitive: 16-Deep by 4-Wide Static Synchronous RAM

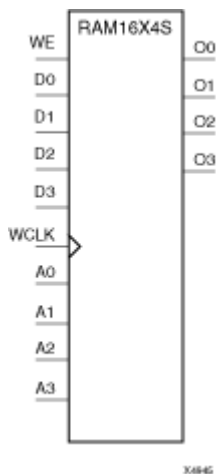

### Introduction

This element is a 16-word by 4-bit static random access memory with synchronous write capability. When the write enable (WE) is Low, transitions on the write clock (WCLK) are ignored and data stored in the RAM is not affected. When WE is High, any positive transition on WCLK loads the data on the data input (D3 – D0) into the word selected by the 4-bit address (A3 – A0). For predictable performance, address and data inputs must be stable before a Low-to-High WCLK transition. This RAM block assumes an active-High WCLK. However, WCLK can be active-High or active-Low. Any inverter placed on the WCLK input net is absorbed into the block.

The signal output on the data output pins (O3 – O0) is the data that is stored in the RAM at the location defined by the values on the address pins.

### Logic Table

Inputs			Outputs
WE (mode)	WCLK	D3 – D0	O3 – O0
0 (read)	X	X	Data
1 (read)	0	X	Data
1 (read)	1	X	Data
1 (write)	↑	D3-D0	D3-D0
1 (read)	↓	X	Data

Data = word addressed by bits A3 – A0.

### Design Entry Method

This design element can be used in schematics.

### Available Attributes

Attribute	Type	Allowed Values	Default	Description
INIT_00 to INIT_03	Hexadecimal	Any 16-Bit Value	All zeros	INIT for bit 0 of RAM



---

## For More Information

- See the [Spartan-3 User Guide](#).
- See the [Spartan-3 Data Sheets](#).

## RAM16X8S

Primitive: 16-Deep by 8-Wide Static Synchronous RAM

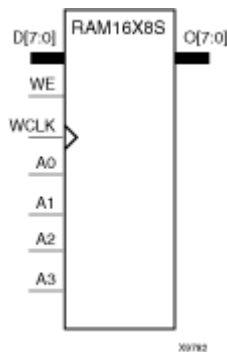

### Introduction

This element is a 16-word by 8-bit static random access memory with synchronous write capability. When the write enable (WE) is Low, transitions on the write clock (WCLK) are ignored and data stored in the RAM is not affected. When WE is High, any positive transition on WCLK loads the data on data inputs (D7 – D0) into the word selected by the 4-bit address (A3 – A0). For predictable performance, address and data inputs must be stable before a Low-to-High WCLK transition. This RAM block assumes an active-High WCLK. However, WCLK can be active-High or active-Low. Any inverter placed on the WCLK input net is absorbed into the block.

The signal output on the data output pins (O7 – O0) is the data that is stored in the RAM at the location defined by the values on the address pins.

### Logic Table

Inputs			Outputs
WE (mode)	WCLK	D7-D0	O7-O0
0 (read)	X	X	Data
1 (read)	0	X	Data
1 (read)	1	X	Data
1 (write)	↑	D7-D0	D7-D0
1 (read)	↓	X	Data

Data = word addressed by bits A3 – A0

### Design Entry Method

This design element can be used in schematics.

### Available Attributes

Attribute	Type	Allowed Values	Default	Description
INIT_00 To INIT_07	Hexadecimal	Any 16-Bit Value	0	Initializes RAMs, registers, and look-up tables.

---

## For More Information

- See the [Spartan-3 User Guide](#).
- See the [Spartan-3 Data Sheets](#).

## RAM32X1S

Primitive: 32-Deep by 1-Wide Static Synchronous RAM

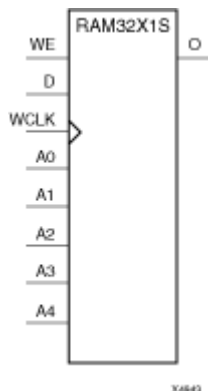

### Introduction

The design element is a 32-word by 1-bit static random access memory with synchronous write capability. When the write enable is Low, transitions on the write clock (WCLK) are ignored and data stored in the RAM is not affected. When (WE) is High, any positive transition on (WCLK) loads the data on the data input (D) into the word selected by the 5-bit address (A4 A0). For predictable performance, address and data inputs must be stable before a Low-to-High (WCLK) transition. This RAM block assumes an active-High (WCLK). However, (WCLK) can be active-High or active-Low. Any inverter placed on the (WCLK) input net is absorbed into the block.

The signal output on the data output pin (O) is the data that is stored in the RAM at the location defined by the values on the address pins. You can initialize RAM32X1S during configuration using the INIT attribute.

### Logic Table

Inputs			Outputs
WE (Mode)	WCLK	D	O
0 (read)	X	X	Data
1 (read)	0	X	Data
1 (read)	1	X	Data
1 (write)	↓	D	D
1 (read)	↑	X	Data

### Design Entry Method

This design element can be used in schematics.

### Available Attributes

Attribute	Type	Allowed Values	Default	Descriptions
INIT	Hexadecimal	Any 32-Bit Value	All zeros	Specifies initial contents of the RAM.

### For More Information

- See the [Spartan-3 User Guide](#).
- See the [Spartan-3 Data Sheets](#).

## RAM32X1S\_1

Primitive: 32-Deep by 1-Wide Static Synchronous RAM with Negative-Edge Clock

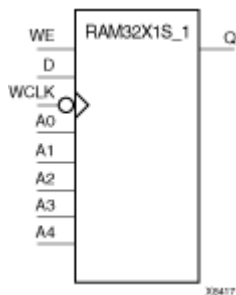

### Introduction

The design element is a 32-word by 1-bit static random access memory with synchronous write capability. When the write enable is Low, transitions on the write clock (WCLK) are ignored and data stored in the RAM is not affected. When (WE) is High, any negative transition on (WCLK) loads the data on the data input (D) into the word selected by the 5-bit address (A4 – A0). For predictable performance, address and data inputs must be stable before a High-to-Low (WCLK) transition. This RAM block assumes an active-Low (WCLK). However, (WCLK) can be active-High or active-Low. Any inverter placed on the (WCLK) input net is absorbed into the block.

The signal output on the data output pin (O) is the data that is stored in the RAM at the location defined by the values on the address pins. You can initialize RAM32X1S\_1 during configuration using the INIT attribute.

### Logic Table

Inputs			Outputs
WE (Mode)	WCLK	D	O
0 (read)	X	X	Data
1 (read)	0	X	Data
1 (read)	1	X	Data
1 (write)	↓	D	D
1 (read)	↑	X	Data

Data = word addressed by bits A4 – A0

### Design Entry Method

This design element can be used in schematics.

### Available Attributes

Attribute	Type	Allowed Values	Default	Descriptions
INIT	Hexadecimal	Any 32-Bit Value	0	Initializes RAMs, registers, and look-up tables.

## For More Information

- See the [Spartan-3 User Guide](#).
- See the [Spartan-3 Data Sheets](#).

## RAM32X2S

Primitive: 32-Deep by 2-Wide Static Synchronous RAM

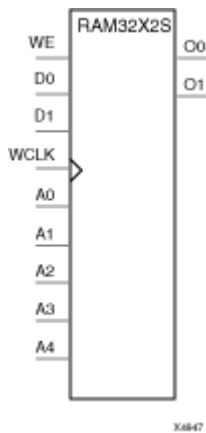

### Introduction

The design element is a 32-word by 2-bit static random access memory with synchronous write capability. When the write enable (WE) is Low, transitions on the write clock (WCLK) are ignored and data stored in the RAM is not affected. When (WE) is High, any positive transition on (WCLK) loads the data on the data input (D1 D0) into the word selected by the 5-bit address (A4 A0). For predictable performance, address and data inputs must be stable before a Low-to-High (WCLK) transition. This RAM block assumes an active-High (WCLK) . However, (WCLK) can be active-High or active-Low. Any inverter placed on the (WCLK) input net is absorbed into the block. The signal output on the data output pins (O1 O0) is the data that is stored in the RAM at the location defined by the values on the address pins.

You can use the INIT\_00 and INIT\_01 properties to specify the initial contents of RAM32X2S.

### Logic Table

Inputs			Outputs
WE (Mode)	WCLK	D	O0-O1
0 (read)	X	X	Data
1 (read)	0	X	Data
1 (read)	1	X	Data
1 (write)	↑	D1-D0	D1-D0
1 (read)	↓	X	Data

Data = word addressed by bits A4 A0

### Design Entry Method

This design element can be used in schematics.

## Available Attributes

Attribute	Type	Allowed Values	Default	Descriptions
INIT_00	Hexadecimal	Any 32-Bit Value	All zeros	INIT for bit 0 of RAM.
INIT_01	Hexadecimal	Any 32-Bit Value	All zeros	INIT for bit 1 of RAM.

## For More Information

- See the [Spartan-3 User Guide](#).
- See the [Spartan-3 Data Sheets](#).



## RAM32X4S

Primitive: 32-Deep by 4-Wide Static Synchronous RAM

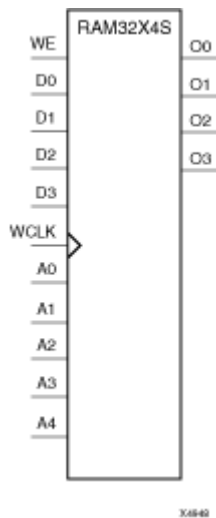

### Introduction

This design element is a 32-word by 4-bit static random access memory with synchronous write capability. When the write enable (WE) is Low, transitions on the write clock (WCLK) are ignored and data stored in the RAM is not affected. When WE is High, any positive transition on WCLK loads the data on the data inputs (D3-D0) into the word selected by the 5-bit address (A4-A0). For predictable performance, address and data inputs must be stable before a Low-to-High WCLK transition. This RAM block assumes an active-High WCLK. However, WCLK can be active-High or active-Low. Any inverter placed on the WCLK input net is absorbed into the block.

The signal output on the data output pins (O3-O0) is the data that is stored in the RAM at the location defined by the values on the address pins.

### Logic Table

Inputs			Outputs
WE	WCLK	D3-D0	O3-O0
0 (read)	X	X	Data
1 (read)	0	X	Data
1 (read)	1	X	Data
1 (write)	↑	D3-D0	D3-D0
1 (read)	↓	X	Data
Data = word addressed by bits A4 A0			

### Design Entry Method

This design element can be used in schematics.

### Available Attributes

Attribute	Type	Allowed Values	Default	Description
INIT_00	Hexadecimal	Any 32-Bit Value	All zeros	INIT for bit 0 of RAM.

Attribute	Type	Allowed Values	Default	Description
INIT_01	Hexadecimal	Any 32-Bit Value	All zeros	INIT for bit 1 of RAM.
INIT_02	Hexadecimal	Any 32-Bit Value	All zeros	INIT for bit 2 of RAM.
INIT_03	Hexadecimal	Any 32-Bit Value	All zeros	INIT for bit 3 of RAM.

### For More Information

- See the [Spartan-3 User Guide](#).
- See the [Spartan-3 Data Sheets](#).

## RAM32X8S

Primitive: 32-Deep by 8-Wide Static Synchronous RAM

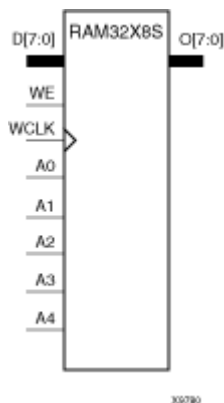

### Introduction

This design element is a 32-word by 8-bit static random access memory with synchronous write capability. When the write enable (WE) is Low, transitions on the write clock (WCLK) are ignored and data stored in the RAM is not affected. When WE is High, any positive transition on WCLK loads the data on the data inputs (D7 – D0) into the word selected by the 5-bit address (A4 – A0). For predictable performance, address and data inputs must be stable before a Low-to-High WCLK transition. This RAM block assumes an active-High WCLK. However, WCLK can be active-High or active-Low. Any inverter placed on the WCLK input net is absorbed into the block.

The signal output on the data output pins (O7 – O0) is the data that is stored in the RAM at the location defined by the values on the address pins.

### Logic Table

Inputs			Outputs
WE (mode)	WCLK	D7-D0	O7-O0
0 (read)	X	X	Data
1 (read)	0	X	Data
1 (read)	1	X	Data
1 (write)	↑	D7-D0	D7-D0
1 (read)	↓	X	Data

Data = word addressed by bits A4 – A0

### Design Entry Method

This design element can be used in schematics.

### Available Attributes

Attribute	Type	Allowed Values	Default	Description
INIT_00	Hexadecimal	Any 32-Bit Value	All zeros	INIT for bit 0 of RAM.
INIT_01	Hexadecimal	Any 32-Bit Value	All zeros	INIT for bit 1 of RAM.
INIT_02	Hexadecimal	Any 32-Bit Value	All zeros	INIT for bit 2 of RAM.

Attribute	Type	Allowed Values	Default	Description
INIT_03	Hexadecimal	Any 32-Bit Value	All zeros	INIT for bit 3 of RAM.
INIT_04	Hexadecimal	Any 32-Bit Value	All zeros	INIT for bit 4 of RAM.
INIT_05	Hexadecimal	Any 32-Bit Value	All zeros	INIT for bit 5 of RAM.
INIT_06	Hexadecimal	Any 32-Bit Value	All zeros	INIT for bit 6 of RAM.
INIT_07	Hexadecimal	Any 32-Bit Value	All zeros	INIT for bit 7 of RAM.

## For More Information

- See the [Spartan-3 User Guide](#).
- See the [Spartan-3 Data Sheets](#).

## RAM64X1S

Primitive: 64-Deep by 1-Wide Static Synchronous RAM

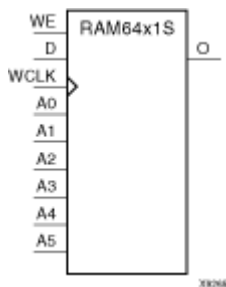

### Introduction

This design element is a 64-word by 1-bit static random access memory (RAM) with synchronous write capability. When the write enable is set Low, transitions on the write clock (WCLK) are ignored and data stored in the RAM is not affected. When WE is set High, any positive transition on WCLK loads the data on the data input (D) into the word selected by the 6-bit address (A5 - A0). This RAM block assumes an active-High WCLK. However, WCLK can be active-High or active-Low. Any inverter placed on the WCLK input net is absorbed into the block.

The signal output on the data output pin (O) is the data that is stored in the RAM at the location defined by the values on the address pins.

You can initialize this element during configuration using the INIT attribute.

### Logic Table

Mode selection is shown in the following logic table

Inputs			Outputs
WE (mode)	WCLK	D	O
0 (read)	X	X	Data
1 (read)	0	X	Data
1 (read)	1	X	Data
1 (write)	↑	D	D
1 (read)	↓	X	Data

Data = word addressed by bits A5 – A0

### Design Entry Method

This design element can be used in schematics.

### Available Attributes

Attribute	Type	Allowed Values	Default	Description
INIT	Hexadecimal	Any 64-Bit Value	All zeros	Initializes ROMs, RAMs, registers, and look-up tables.

## For More Information

- See the [Spartan-3 User Guide](#).
- See the [Spartan-3 Data Sheets](#).

## RAM64X1S\_1

Primitive: 64-Deep by 1-Wide Static Synchronous RAM with Negative-Edge Clock

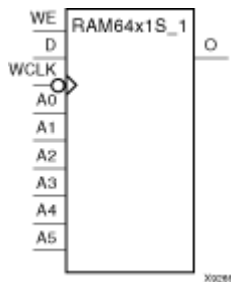

### Introduction

This design element is a 64-word by 1-bit static random access memory with synchronous write capability. When the write enable is Low, transitions on the write clock (WCLK) are ignored and data stored in the RAM is not affected. When (WE) is High, any negative transition on (WCLK) loads the data on the data input (D) into the word selected by the 6-bit address (A5 – A0). For predictable performance, address and data inputs must be stable before a High-to-Low (WCLK) transition. This RAM block assumes an active-Low (WCLK). However, (WCLK) can be active-High or active-Low. Any inverter placed on the (WCLK) input net is absorbed into the block.

The signal output on the data output pin (O) is the data that is stored in the RAM at the location defined by the values on the address pins.

You can initialize this element during configuration using the INIT attribute.

### Logic Table

Inputs			Outputs
WE (mode)	WCLK	D	O
0 (read)	X	X	Data
1 (read)	0	X	Data
1 (read)	1	X	Data
1 (write)	↓	D	D
1 (read)	↑	X	Data

Data = word addressed by bits A5 – A0

### Design Entry Method

This design element can be used in schematics.

### Available Attributes

Attribute	Type	Allowed Values	Default	Description
INIT	Hexadecimal	Any 64-Bit Value	All zeros	Initializes ROMs, RAMs, registers, and look-up tables.

### For More Information

- See the [Spartan-3 User Guide](#).
- See the [Spartan-3 Data Sheets](#).

## RAM64X2S

Primitive: 64-Deep by 2-Wide Static Synchronous RAM

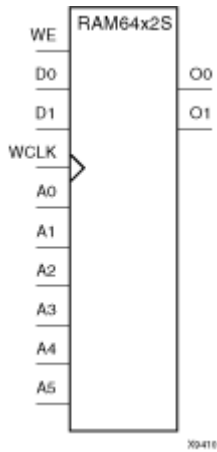

### Introduction

This design element is a 64-word by 2-bit static random access memory with synchronous write capability. When the write enable (WE) is Low, transitions on the write clock (WCLK) are ignored and data stored in the RAM is not affected. When WE is High, any positive transition on WCLK loads the data on the data input (D1 – D0) into the word selected by the 6-bit address (A5 – A0). For predictable performance, address and data inputs must be stable before a Low-to-High WCLK transition. This RAM block assumes an active-High WCLK. However, WCLK can be active-High or active-Low. Any inverter placed on the WCLK input net is absorbed into the block.

The signal output on the data output pins (O1 – O0) is the data that is stored in the RAM at the location defined by the values on the address pins. You can use the INIT\_00 and INIT\_01 properties to specify the initial contents of this design element.

### Logic Table

Inputs			Outputs
WE (mode)	WCLK	D0-D1	O0-O1
0 (read)	X	X	Data
1 (read)	0	X	Data
1 (read)	1	X	Data
1 (write)	↑	D1-D0	D1-D0
1 (read)	↓	X	Data

Data = word addressed by bits A5 – A0

### Design Entry Method

This design element can be used in schematics.



## Available Attributes

Attribute	Type	Allowed Values	Default	Description
INIT_00	Hexadecimal	Any 64-Bit Value	All zeros	Initializes RAMs, registers, and look-up tables.
INIT_01	Hexadecimal	Any 64-Bit Value	All zeros	Initializes RAMs, registers, and look-up tables.

## For More Information

- See the [Spartan-3 User Guide](#).
- See the [Spartan-3 Data Sheets](#).

# RAMB16\_S1

Primitive: 16K-bit Data and 2K-bit Parity Single-Port Synchronous Block RAM with 1-bit Port

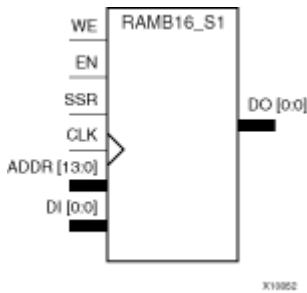

## Introduction

This design element is a dedicated random access memory blocks with synchronous write capability. The block RAM port has 16384 bits of data memory.

The enable EN pin controls read, write, and reset for Port A. When EN is Low, no data is written and the outputs (DOA and DOPA) retain the last state. When EN is High and reset (SSRA) is High, DOA and DOPA are set to SRVAL\_A during the Low-to-High clock (CLKA) transition; if write enable (WEA) is High, the memory contents reflect the data at DIA and DIPA. When EN is High and WEA is Low, the data stored in the RAM address (ADDR\_A) is read during the Low-to-High clock transition. By default, WRITE\_MODE\_A=WRITE\_FIRST, when EN and WEA are High, the data on the data inputs (DIA and DIPA) is loaded into the word selected by the write address (ADDR\_A) during the Low-to-High clock transition and the data outputs (DOA and DOPA) reflect the selected (addressed) word.

The above description assumes an active High EN, WE, SSR, and CLK. However, the active level can be changed by placing an inverter on the port. Any inverter placed on a RAMB16 port is absorbed into the block and does not use a CLB resource.

## Port Descriptions

Inputs								Outputs			
GSR	EN	SSR	WE	CLK	ADDR	DI	DIP	DO	DOP	RAM Contents	
										Data RAM	Parity RAM
1	X	X	X	X	X	X	X	INIT	INIT	No Change	No Change
0	0	X	X	X	X	X	X	No Change	No Change	No Change	No Change
0	1	1	0	↑	X	X	X	SRVAL	SRVAL	No Change	No Change
0	1	1	1	↑	addr	data	pdata	SRVAL	SRVAL	RAM(addr) =>data	RAM(addr) =>pdata
0	1	0	0	↑	addr	X	X	RAM(addr)	RAM(addr)	No Change	No Change

Inputs								Outputs			
GSR	EN	SSR	WE	CLK	ADDR	DI	DIP	DO	DOP	RAM Contents	
										Data RAM	Parity RAM
0	1	0	1	↑	addr	data	pdata	No Change(a) RAM (addr)(b) data(c)	No Change(a) RAM (addr)(b) pdata(c)	RAM (addr)=>data	RAM (addr)=>pdata

GSR=Global Set Reset signal  
 INIT=Value specified by the INIT attribute for data memory. Default is all zeros.  
 SRVAL=Value after assertion of SSR as specified by the SRVAL attribute.  
 addr=RAM address.  
 RAM(addr)=RAM contents at address ADDR.  
 data=RAM input data.  
 pdata=RAM parity data.  
 (a) WRITE\_MODE=NO\_CHANGE  
 (b) WRITE\_MODE=READ\_FIRST  
 (c) WRITE\_MODE=WRITE\_FIRST

*Initializing Memory Contents of a Single-Port RAMB16*

You can use the INIT\_xx attributes to specify an initialization value for the memory contents of a RAMB16 during device configuration. The initialization of each RAMB16\_Sn is set by 64 initialization attributes (INIT\_00 through INIT\_3F) of 64 hex values for a total of 16384 bits.

You can use the INITP\_xx attributes to specify an initial value for the parity memory during device configuration or assertion. The initialization of the parity memory for ports configured for 9, 18, or 36 bits is set by 8 initialization attributes (INITP\_00 through INITP\_07) of 64 hex values for a total of 2048 bits.

If any INIT\_xx or INITP\_xx attribute is not specified, it is configured as zeros. Partial Strings are padded with zeros to the left.

*Initializing the Output Register of a Single-Port RAMB16*

In Spartan-3A, each bit in the output register can be initialized at power on to either a 0 or 1. In addition, the initial state specified for power on can be different than the state that results from assertion of a set/reset. Two types of properties control initialization of the output register for a single-port RAMB16: INIT and SRVAL. The INIT attribute specifies the output register value at power on. You can use the SRVAL attribute to define the state resulting from assertion of the SSR (set/reset) input.

The INIT and SRVAL attributes specify the initialization value as a hexadecimal String. The value is dependent upon the port width. For example, for a RAMB16\_S1 with port width equal to 1, the output register contains 1 bit. Therefore, the INIT or SRVAL value can only be specified as a 1 or 0. For RAMB16\_S4 with port width equal to 4, the output register contains 4 bits. In this case, you can specify a hexadecimal value from 0 through F to initialize the 4 bits of the output register.

For those ports that include parity bits, the parity portion of the output register is specified in the high order bit position of the INIT or SRVAL value.

The INIT and SRVAL attributes default to zero if they are not set by you.

*Write Mode Selection*

The WRITE\_MODE attribute controls RAMB16 memory and output contents. By default, the WRITE\_MODE is set to WRITE\_FIRST. This means that input is read, written to memory, and then passed to output. You can set the WRITE\_MODE to READ\_FIRST to read the memory contents, pass the memory contents to the outputs, and then write the input to memory. Or, you can set the WRITE\_MODE to NO\_CHANGE to have the input written to memory without changing the output.

The cell configuration for this element is listed in the following table.

Component	Data Cells		Parity Cells				
	Depth	Width	Depth	Width	Address Bus	Data Bus	Parity Bus
RAMB16_S1	16384	1	-	-	(13:0)	(0:0)	-

## Design Entry Method

This design element can be used in schematics.

## Available Attributes

Attribute	Type	Allowed Values	Default	Description
INIT	Binary	Any Hex Value	All zeros	Identifies the initial value of the DO output port after completing configuration. The bit width is dependent on the width of the A or B port of the RAM.
INIT_00 - INIT_3F	Binary	Any Hex Value	All zeros	Specifies the initial contents of the data portion of the RAM array.
INITP_00 - INITP_07	Binary	Any Hex Value	All zeros	Specifies the initial contents of the parity portion of the RAM array.
SRVAL	Binary	Any Hex Value	All zeros	Allows the individual selection of whether the DO output port sets (go to a one) or reset (go to a zero) upon the assertion of the SSR pin. The bit width is dependent on the width of the A or B port of the RAM.
WRITE_MODE	String	"WRITE_FIRST", "READ_FIRST" or "NO_CHANGE"	"WRITE_FIRST"	Specifies the behavior of the DO port upon a write command to the respected port. If set to "WRITE_FIRST", the same port that is written to displays the contents of the written data to the outputs upon completion of the operation. "READ_FIRST" displays the prior contents of the RAM to the output port prior to writing the new data. "NO_CHANGE" keeps the previous value on the output port and won't update the output port upon a write command. This is the suggested mode if not using the read data from a particular port of the RAM.

## For More Information

- See the [Spartan-3 User Guide](#).
- See the [Spartan-3 Data Sheets](#).

# RAMB16\_S1\_S1

Primitive: 16K-bit Data and 2K-bit Parity Dual-Port Synchronous Block RAM with 1-bit Ports

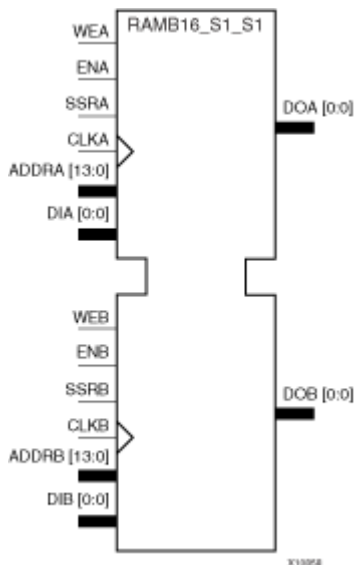

## Introduction

This design element is a dual-ported dedicated random access memory block with synchronous write capability. Each block RAM port has 16384 bits of data memory. Ports configured as 9, 18, or 36-bits wide have an additional 2048 bits of parity memory. Each port is independent of the other while accessing the same set of 16384 data memory cells. Each port is independently configured to a specific data width. The possible port and cell configurations for this element are listed under "Port Descriptions."

## Logic Table

Truth Table A

Inputs								Outputs			
GSR	ENA	SSRA	WEA	CLKA	ADDRa	DIA	DIPA	DOA	DOPA	RAM Contents	
										Data RAM	Parity RAM
1	X	X	X	X	X	X	X	INIT_A	INIT_A	No Change	No Change
0	0	X	X	X	X	X	X	No Change	No Change	No Change	No Change
0	1	1	0	↑	X	X	X	SRVAL_A	SRVAL_A	No Change	No Change
0	1	1	1	↑	addr	data	pdata	SRVAL_A	SRVAL_A	RAM(addr) =>data	RAM(addr) =>pdata
0	1	0	0	↑	addr	X	X	RAM(addr)	RAM(addr)	No Change	No Change

Inputs								Outputs			
GSR	ENA	SSRA	WEA	CLKA	ADDRA	DIA	DIPA	DOA	DOPA	RAM Contents	
										Data RAM	Parity RAM
0	1	0	1	↑	addr	data	pdata	No Change1, RAM (addr)2, data3	No Change1, RAM (addr)2, pdata3	RAM(addr) =>data	RAM(addr) =>pdata

GSR=Global Set Reset  
 INIT\_A=Value specified by the INIT\_A attribute for output register. Default is all zeros.  
 SRVAL\_A=register value.  
 addr=RAM address.  
 RAM(addr)=RAM contents at address ADDR.  
 data=RAM input data.  
 pdata=RAM parity data.  
 1WRITE\_MODE\_A=NO\_CHANGE.  
 2WRITE\_MODE\_A=READ\_FIRST.  
 3WRITE\_MODE\_A=WRITE\_FIRST.

Truth Table B

Inputs								Outputs			
GSR	ENB	SSRB	WEB	CLKB	ADDRB	DIB	DIPB	DOB	DOPB	RAM Contents	
										Data RAM	Parity RAM
1	X	X	X	X	X	X	X	INIT_B	INIT_B	No Change	No Change
0	0	X	X	X	X	X	X	No Change	No Change	No Change	No Change
0	1	1	0	↑	X	X	X	SRVAL_B	SRVAL_B	No Change	No Change
0	1	1	1	↑	addr	data	pdata	SRVAL_B	SRVAL_B	RAM(addr) =>data	RAM(addr) =>pdata
0	1	0	0	↑	addr	X	X	RAM(addr)	RAM(addr)	No Change	No Change
0	1	0	1	↑	addr	data	pdata	No Change1, RAM (addr)2, data3	No Change1, RAM (addr)2, pdata3	RAM(addr)2	RAM(addr) =>pdata

GSR=Global Set Reset.  
 INIT\_B=Value specified by the INIT\_B attribute for output registers. Default is all zeros.  
 SRVAL\_B=register value.  
 addr=RAM address.  
 RAM(addr)=RAM contents at address ADDR.  
 data=RAM input data.  
 pdata=RAM parity data.  
 1WRITE\_MODE\_B=NO\_CHANGE.  
 2WRITE\_MODE\_B=READ\_FIRST.  
 3WRITE\_MODE\_B=WRITE\_FIRST.

## Port Descriptions

Port A						Port B				
Component	Data Cells(a)	Parity Cells(a)	Address Bus	Data Bus	Parity Bus	Data Cells(a)	Parity Cells(a)	Address Bus	Data Bus	Parity Bus
RAMB16_S1_S1	16384 x 1	-	(13:0)	(0:0)	-	16384 x 1	-	(13:0)	(0:0)	-
(a) Depth x Width										

Each port is fully synchronous with independent clock pins. All Port A input pins have setup time referenced to the CLKA pin and its data output bus DOA has a clock-to-out time referenced to the CLKA. All Port B input pins have setup time referenced to the CLKB pin and its data output bus DOB has a clock-to-out time referenced to the CLKB. The enable ENA pin controls read, write, and reset for Port A. When ENA is Low, no data is written and the outputs (DOA and DOPA) retain the last state. When ENA is High and reset (SSRA) is High, DOA and DOPA are set to SRVAL\_A during the Low-to-High clock (CLKA) transition; if write enable (WEA) is High, the memory contents reflect the data at DIA and DIPA. When ENA is High and WEA is Low, the data stored in the RAM address (ADDRA) is read during the Low-to-High clock transition. By default, WRITE\_MODE\_A=WRITE\_FIRST, when ENA and WEA are High, the data on the data inputs (DIA and DIPA) is loaded into the word selected by the write address (ADDRA) during the Low-to-High clock transition and the data outputs (DOA and DOPA) reflect the selected (addressed) word.

The enable ENB pin controls read, write, and reset for Port B. When ENB is Low, no data is written and the outputs (DOB and DOPB) retain the last state. When ENB is High and reset (SSRB) is High, DOB and DOPB are set to SRVAL\_B during the Low-to-High clock (CLKB) transition; if write enable (WEB) is High, the memory contents reflect the data at DIB and DIPB. When ENB is High and WEB is Low, the data stored in the RAM address (ADDRB) is read during the Low-to-High clock transition. By default, WRITE\_MODE\_B=WRITE\_FIRST, when ENB and WEB are High, the data on the data inputs (DIB and DIPB) are loaded into the word selected by the write address (ADDRB) during the Low-to-High clock transition and the data outputs (DOB and DOPB) reflect the selected (addressed) word. The above descriptions assume active High control pins (ENA, WEA, SSRA, CLKA, ENB, WEB, SSRB, and CLKB). However, the active level can be changed by placing an inverter on the port. Any inverter placed on a RAMB16 port is absorbed into the block and does not use a CLB resource.

### Address Mapping

Each port accesses the same set of 18432 memory cells using an addressing scheme that is dependent on the width of the port. For all port widths, 16384 memory cells are available for data as shown in the "Port Address Mapping for Data" table below. For 9-, 18-, and 36-bit wide ports, 2408 parity memory cells are also available as shown in "Port Address Mapping for Parity" table below. The physical RAM location that is addressed for a particular width is determined from the following formula.

$$\text{Start} = ((\text{ADDR}_{\text{port}} + 1) * (\text{Width}_{\text{port}})) - 1$$

$$\text{End} = (\text{ADDR}_{\text{port}}) * (\text{Width}_{\text{port}})$$

The following tables shows address mapping for each port width.

### Port Address Mapping for Data

Data Width	Port Data Addresses																																		
1	16384	<--	31	30	29	28	27	26	25	24	23	22	21	20	19	18	17	16	15	14	13	12	11	10	9	8	7	6	5	4	3	2	1	0	
2	8192	<--	15		14		13		12		11		10		9		8		7		6		5		4		3		2		1		0		
4	4096	<--	7				6				5				4				3				2				1				0				
8	2048	<--	3								2								1								0								
16	1024	<--	1																0																
32	512	<--	0																																

### Port Address Mapping for Parity

Parity Width	Port Parity Addresses																	
1	2048	<-----	3					2					1					0
2	1024	<-----	1										0					
4	512	<-----	0															

#### Initializing Memory Contents of a Dual-Port RAMB16

You can use the INIT\_XX attributes to specify an initialization value for the memory contents of a RAMB16 during device configuration. The initialization of each RAMB16\_Sm\_Sn is set by 64 initialization attributes (INIT\_00 through INIT\_3F) of 64 hex values for a total of 16384 bits.

You can use the INITP\_XX attributes to specify an initial value for the parity memory during device configuration or assertion. The initialization of the parity memory for ports configured for 9, 18, or 36 bits is set by 8 initialization attributes (INITP\_00 through INITP\_07) of 64 hex values for a total of 2048 bits.

If any INIT\_XX or INITP\_XX attribute is not specified, it is configured as zeros. Partial Strings are padded with zeros to the left.

#### Initializing the Output Register of a Dual-Port RAMB16

In Spartan-3A, each bit in an output register can be initialized at power on (when GSR is high) to either a 0 or 1. In addition, the initial state specified for power on can be different than the state that results from assertion of a set/reset. Four properties control initialization of the output register for a dual-port RAMB16: INIT\_A, INIT\_B, SRVAL\_A, and SRVAL\_B. The INIT\_A attribute specifies the output register value at power on for Port A and the INIT\_B attribute specifies the value for Port B. You can use the SRVAL\_A attribute to define the state resulting from assertion of the SSR (set/reset) input on Port A. You can use the SRVAL\_B attribute to define the state resulting from assertion of the SSR input on Port B.

The INIT\_A, INIT\_B, SRVAL\_A, and SRVAL\_B attributes specify the initialization value as a hexadecimal String. The value is dependent upon the port width. For example, for a RAMB16\_S1\_S4 with Port A width equal to 1 and Port B width equal to 4, the Port A output register contains 1 bit and the Port B output register contains 4 bits. Therefore, the INIT\_A or SRVAL\_A value can only be specified as a 1 or 0. For Port B, the output register contains 4 bits. In this case, you can use INIT\_B or SRVAL\_B to specify a hexadecimal value from 0 through F to initialize the 4 bits of the output register.

For those ports that include parity bits, the parity portion of the output register is specified in the high order bit position of the INIT\_A, INIT\_B, SRVAL\_A, or SRVAL\_B value.

The INIT and SRVAL attributes default to zero if they are not set by you.

#### Write Mode Selection

The WRITE\_MODE\_A attribute controls the memory and output contents of Port A for a dual-port RAMB16. The WRITE\_MODE\_B attribute does the same for Port B. By default, both WRITE\_MODE\_A and WRITE\_MODE\_B are set to WRITE\_FIRST. This means that input is read, written to memory, and then passed to output. You can set the write mode for Port A and Port B to READ\_FIRST to read the memory contents, pass the memory contents to the outputs, and then write the input to memory. Or, you can set the write mode to NO\_CHANGE to have the input written to memory without changing the output. The "Port A and Port B Conflict Resolution" section describes how read/write conflicts are resolved when both Port A and Port B are attempting to read/write to the same memory cells.

#### Port A and Port B Conflict Resolution

Spartan-3A block SelectRAM is True Dual-Port RAM that allows both ports to simultaneously access the same memory cell. When one port writes to a given memory cell, the other port must not address that memory cell (for a write or a read) within the clock-to-clock setup window.

The following tables summarize the collision detection behavior of the dual-port RAMB16 based on the WRITE\_MODE\_A and WRITE\_MODE\_B settings.

*WRITE\_MODE\_A=NO\_CHANGE and WRITE\_MODE\_B=NO\_CHANGE*



WEA	WEB	CLKA	CLKB	DIA	DIB	DIPA	DIPB	DOA	DOB	DOPA	DOPB	Data RAM	Parity Ram
0	0	↑	↑	DIA	DIB	DIPA	DIPB	RAM	RAM	RAM	RAM	No Change	No Change
1	0	↑	↑	DIA	DIB	DIPA	DIPB	No Change	X	No Change	X	DIA	DIPA
0	1	↑	↑	DIA	DIB	DIPA	DIPB	X	No Change	X	No Change	DIB	DIPB
1	1	↑	↑	DIA	DIB	DIPA	DIPB	No Change	No Change	No Change	No Change	X	X

*WRITE\_MODE\_A=READ\_FIRST and WRITE\_MODE\_B=READ\_FIRST*

WEA	WEB	CLKA	CLKB	DIA	DIB	DIPA	DIPB	DOA	DOB	DOPA	DOPB	Data RAM	Parity Ram
0	0	↑	↑	DIA	DIB	DIPA	DIPB	RAM	RAM	RAM	RAM	No Change	No Change
1	0	↑	↑	DIA	DIB	DIPA	DIPB	RAM	RAM	RAM	RAM	DIA	DIPA
0	1	↑	↑	DIA	DIB	DIPA	DIPB	RAM	RAM	RAM	RAM	DIB	DIPB
1	1	↑	↑	DIA	DIB	DIPA	DIPB	RAM	RAM	RAM	RAM	X	X

*WRITE\_MODE\_A= WRITE\_FIRST and WRITE\_MODE\_B=WRITE\_FIRST*

WEA	WEB	CLKA	CLKB	DIA	DIB	DIPA	DIPB	DOA	DOB	DOPA	DOPB	Data RAM	Parity Ram
0	0	↑	↑	DIA	DIB	DIPA	DIPB	RAM	RAM	RAM	RAM	No Change	No Change
1	0	↑	↑	DIA	DIB	DIPA	DIPB	DIA	X	DIPA	X	DIA	DIPA
0	1	↑	↑	DIA	DIB	DIPA	DIPB	X	DIB	X	DIPB	DIB	DIPB
1	1	↑	↑	DIA	DIB	DIPA	DIPB	X	X	X	X	X	X

*WRITE\_MODE\_A=NO\_CHANGE and WRITE\_MODE\_B=READ\_FIRST*

WEA	WEB	CLKA	CLKB	DIA	DIB	DIPA	DIPB	DOA	DOB	DOPA	DOPB	Data RAM	Parity Ram
0	0	↑	↑	DIA	DIB	DIPA	DIPB	RAM	RAM	RAM	RAM	No Change	No Change
1	0	↑	↑	DIA	DIB	DIPA	DIPB	No Change	X	No Change	X	DIA	DIPA
0	1	↑	↑	DIA	DIB	DIPA	DIPB	RAM	RAM	RAM	RAM	DIB	DIPB
1	1	↑	↑	DIA	DIB	DIPA	DIPB	No Change	X	No Change	X	DIB	DIPB

*WRITE\_MODE\_A=NO\_CHANGE and WRITE\_MODE\_B=WRITE\_FIRST*

WEA	WEB	CLKA	CLKB	DIA	DIB	DIPA	DIPB	DOA	DOB	DOPA	DOPB	Data RAM	Parity Ram
0	0	↑	↑	DIA	DIB	DIPA	DIPB	RAM	RAM	RAM	RAM	No Change	No Change
1	0	↑	↑	DIA	DIB	DIPA	DIPB	No Change	X	No Change	X	DIA	DIPA
0	1	↑	↑	DIA	DIB	DIPA	DIPB	X	DIB	X	DIPB	DIB	DIPB
1	1	↑	↑	DIA	DIB	DIPA	DIPB	No Change	X	No Change	X	X	X

*WRITE\_MODE\_A=READ\_FIRST and WRITE\_MODE\_B=WRITE\_FIRST*

WEA	WEB	CLKA	CLKB	DIA	DIB	DIPA	DIPB	DOA	DOB	DOPA	DOPB	Data RAM	Parity Ram
0	0	↑	↑	DIA	DIB	DIPA	DIPB	RAM	RAM	RAM	RAM	No Change	No Change
1	0	↑	↑	DIA	DIB	DIPA	DIPB	RAM	RAM	RAM	RAM	DIA	DIPA
0	1	↑	↑	DIA	DIB	DIPA	DIPB	X	DIB	X	DIPB	DIB	DIPB
1	1	↑	↑	DIA	DIB	DIPA	DIPB	X	DIB	X	DIPB	DIA	DIPA

## Design Entry Method

This design element can be used in schematics.

## Available Attributes

Attribute	Type	Allowed Values	Default	Description
INIT_00 To INIT_3F	Binary/Hexadecimal	Any	All zeros	Specifies the initial contents of the data portion of the RAM array.
INIT_A	Binary/Hexadecimal	Any	All zeros	Identifies the initial value of the DOA/DOB output port after completing configuration. For Type, the bit width is dependent on the width of the A or B port of the RAM.
INIT_B	Binary/Hexadecimal	Any	All zeros	Identifies the initial value of the DOA/DOB output port after completing configuration. For Type, the bit width is dependent on the width of the A or B port of the RAM.
INITP_00 To INITP_07	Binary/Hexadecimal	Any	All zeros	Specifies the initial contents of the parity portion of the RAM array.
SIM_COLLISION_CHECK	String	"ALL", "NONE", "WARNING", or "GENERATE_X_ONLY"	"ALL"	Specifies the behavior during simulation in the event of a data collision (data being read or written to the same address from both ports of the Ram simultaneously. "ALL" issues a warning to simulator console and generate an X or all unknown data due to the collision. This is the recommended setting. "WARNING" generates a warning only and "GENERATE_X_ONLY" generates an X for unknown data but won't output the occurrence to the simulation console. "NONE" completely ignores the error. It is suggested to only change this attribute if you can ensure the data generated during a collision is discarded.

Attribute	Type	Allowed Values	Default	Description
SRVAL_A	Binary/Hexadecimal	Any	All zeros	Allows the individual selection of whether the DOA/DOB output port sets (go to a one) or reset (go to a zero) upon the assertion of the RSTA pin. For Type, the bit width is dependent on the width of the A port of the RAM.
SRVAL_B	Binary/Hexadecimal	Any	All zeros	Allows the individual selection of whether the DOA/DOB output port sets (go to a one) or reset (go to a zero) upon the assertion of the RSTB pin. For Type, the bit width is dependent on the width of the B port of the RAM.
WRITE_MODE_A	String	"WRITE_FIRST", "READ_FIRST" or "NO_CHANGE"	"WRITE_FIRST"	Specifies the behavior of the DOA/DOB port upon a write command to the respected port. If set to WRITE_FIRST, the same port that is written to displays the contents of the written data to the outputs upon completion of the operation. "READ_FIRST" displays the prior contents of the RAM to the output port prior to writing the new data. "NO_CHANGE" keeps the previous value on the output port and won't update the output port upon a write command. This is the suggested mode if not using the read data from a particular port of the RAM
WRITE_MODE_B	String	"WRITE_FIRST", "READ_FIRST" or "NO_CHANGE"	"WRITE_FIRST"	Specifies the behavior of the DOA/DOB port upon a write command to the respected port. If set to WRITE_FIRST, the same port that is written to displays the contents of the written data to the outputs upon completion of the operation. "READ_FIRST" displays the prior contents of the RAM to the output port prior to writing the new data. "NO_CHANGE" keeps the previous value on the output port and won't update the output port upon a write command. This is the suggested mode if not using the read data from a particular port of the RAM.

## For More Information

- See the [Spartan-3 User Guide](#).
- See the [Spartan-3 Data Sheets](#).

# RAMB16\_S1\_S18

Primitive: 16K-bit Data and 2K-bit Parity Dual-Port Synchronous Block RAM with 1-bit and 18-bit Ports

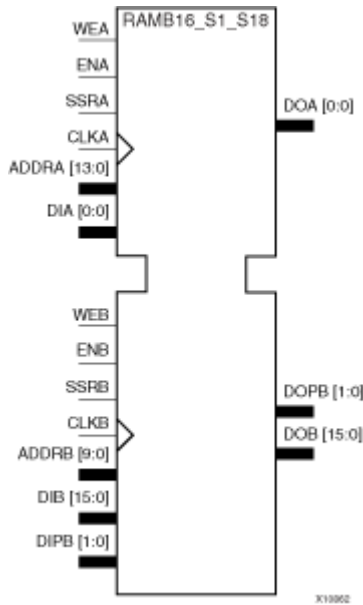

## Introduction

This design element is a dual-ported dedicated random access memory block with synchronous write capability. Each block RAM port has 16384 bits of data memory. Ports configured as 9, 18, or 36-bits wide have an additional 2048 bits of parity memory. Each port is independent of the other while accessing the same set of 16384 data memory cells. Each port is independently configured to a specific data width. The possible port and cell configurations for this element are listed under "Port Descriptions."

## Logic Table

Truth Table A

Inputs								Outputs			
GSR	ENA	SSRA	WEA	CLKA	ADDR_A	DIA	DIPA	DOA	DOPA	RAM Contents	
										Data RAM	Parity RAM
1	X	X	X	X	X	X	X	INIT_A	INIT_A	No Change	No Change
0	0	X	X	X	X	X	X	No Change	No Change	No Change	No Change
0	1	1	0	↑	X	X	X	SRVAL_A	SRVAL_A	No Change	No Change
0	1	1	1	↑	addr	data	pdata	SRVAL_A	SRVAL_A	RAM(addr) =>data	RAM(addr) =>pdata
0	1	0	0	↑	addr	X	X	RAM(addr)	RAM(addr)	No Change	No Change

Inputs								Outputs			
GSR	ENA	SSRA	WEA	CLKA	ADDRA	DIA	DIPA	DOA	DOPA	RAM Contents	
										Data RAM	Parity RAM
0	1	0	1	↑	addr	data	pdata	No Change1, RAM (addr)2, data3	No Change1, RAM (addr)2, pdata3	RAM(addr) =>data	RAM(addr) =>pdata

GSR=Global Set Reset  
 INIT\_A=Value specified by the INIT\_A attribute for output register. Default is all zeros.  
 SRVAL\_A=register value.  
 addr=RAM address.  
 RAM(addr)=RAM contents at address ADDR.  
 data=RAM input data.  
 pdata=RAM parity data.  
 1WRITE\_MODE\_A=NO\_CHANGE.  
 2WRITE\_MODE\_A=READ\_FIRST.  
 3WRITE\_MODE\_A=WRITE\_FIRST.

Truth Table B

Inputs								Outputs			
GSR	ENB	SSRB	WEB	CLKB	ADDRB	DIB	DIPB	DOB	DOPB	RAM Contents	
										Data RAM	Parity RAM
1	X	X	X	X	X	X	X	INIT_B	INIT_B	No Change	No Change
0	0	X	X	X	X	X	X	No Change	No Change	No Change	No Change
0	1	1	0	↑	X	X	X	SRVAL_B	SRVAL_B	No Change	No Change
0	1	1	1	↑	addr	data	pdata	SRVAL_B	SRVAL_B	RAM(addr) =>data	RAM(addr) =>pdata
0	1	0	0	↑	addr	X	X	RAM(addr)	RAM(addr)	No Change	No Change
0	1	0	1	↑	addr	data	pdata	No Change1, RAM (addr)2, data3	No Change1, RAM (addr)2, pdata3	RAM(addr)2	RAM(addr) =>pdata

GSR=Global Set Reset.  
 INIT\_B=Value specified by the INIT\_B attribute for output registers. Default is all zeros.  
 SRVAL\_B=register value.  
 addr=RAM address.  
 RAM(addr)=RAM contents at address ADDR.  
 data=RAM input data.  
 pdata=RAM parity data.  
 1WRITE\_MODE\_B=NO\_CHANGE.  
 2WRITE\_MODE\_B=READ\_FIRST.

See the ISE 10.1 User Guide for Schematic Designs

## Port Descriptions

Port A						Port B				
Component	Data Cells(a)	Parity Cells(a)	Address Bus	Data Bus	Parity Bus	Data Cells(a)	Parity Cells(a)	Address Bus	Data Bus	Parity Bus
RAMB16_S1_S18	16384 x 1	-	(13:0)	(0:0)	-	1024 x 16	1024 x 2	(9:0)	(15:0)	(1:0)
(a) Depth x Width										

Each port is fully synchronous with independent clock pins. All Port A input pins have setup time referenced to the CLKA pin and its data output bus DOA has a clock-to-out time referenced to the CLKA. All Port B input pins have setup time referenced to the CLKB pin and its data output bus DOB has a clock-to-out time referenced to the CLKB. The enable ENA pin controls read, write, and reset for Port A. When ENA is Low, no data is written and the outputs (DOA and DOPA) retain the last state. When ENA is High and reset (SSRA) is High, DOA and DOPA are set to SRVAL\_A during the Low-to-High clock (CLKA) transition; if write enable (WEA) is High, the memory contents reflect the data at DIA and DIPA. When ENA is High and WEA is Low, the data stored in the RAM address (ADDR\_A) is read during the Low-to-High clock transition. By default, WRITE\_MODE\_A=WRITE\_FIRST, when ENA and WEA are High, the data on the data inputs (DIA and DIPA) is loaded into the word selected by the write address (ADDR\_A) during the Low-to-High clock transition and the data outputs (DOA and DOPA) reflect the selected (addressed) word.

The enable ENB pin controls read, write, and reset for Port B. When ENB is Low, no data is written and the outputs (DOB and DOPB) retain the last state. When ENB is High and reset (SSRB) is High, DOB and DOPB are set to SRVAL\_B during the Low-to-High clock (CLKB) transition; if write enable (WEB) is High, the memory contents reflect the data at DIB and DIPB. When ENB is High and WEB is Low, the data stored in the RAM address (ADDRB) is read during the Low-to-High clock transition. By default, WRITE\_MODE\_B=WRITE\_FIRST, when ENB and WEB are High, the data on the data inputs (DIB and IPB) are loaded into the word selected by the write address (ADDRB) during the Low-to-High clock transition and the data outputs (DOB and DOPB) reflect the selected (addressed) word. The above descriptions assume active High control pins (ENA, WEA, SSRA, CLKA, ENB, WEB, SSRB, and CLKB). However, the active level can be changed by placing an inverter on the port. Any inverter placed on a RAMB16 port is absorbed into the block and does not use a CLB resource.

### Address Mapping

Each port accesses the same set of 18432 memory cells using an addressing scheme that is dependent on the width of the port. For all port widths, 16384 memory cells are available for data as shown in the "Port Address Mapping for Data" table below. For 9-, 18-, and 36-bit wide ports, 2408 parity memory cells are also available as shown in "Port Address Mapping for Parity" table below. The physical RAM location that is addressed for a particular width is determined from the following formula.

$$\text{Start} = ((\text{ADDR port} + 1) * (\text{Widthport})) - 1$$

$$\text{End} = (\text{ADDRport}) * (\text{Widthport})$$

The following tables shows address mapping for each port width.

### Port Address Mapping for Data

Data Width	Port Data Addresses
1	16384 <-- 31 30 29 28 27 26 25 24 23 22 21 20 19 18 17 16 15 14 13 12 11 10 9 8 7 6 5 4 3 2 1 0
2	8192 <-- 15 14 13 12 11 10 9 8 7 6 5 4 3 2 1 0
4	4096 <-- 7 6 5 4 3 2 1 0
8	2048 <-- 3 2 1 0
16	1024 <-- 1 0
32	512 <-- 0

### Port Address Mapping for Parity

Parity Width	Port Parity Addresses																
1	2048	<-----	3					2					1				0
2	1024	<-----	1										0				
4	512	<-----	0														

#### Initializing Memory Contents of a Dual-Port RAMB16

You can use the INIT\_xx attributes to specify an initialization value for the memory contents of a RAMB16 during device configuration. The initialization of each RAMB16\_Sm\_Sn is set by 64 initialization attributes (INIT\_00 through INIT\_3F) of 64 hex values for a total of 16384 bits.

You can use the INITP\_xx attributes to specify an initial value for the parity memory during device configuration or assertion. The initialization of the parity memory for ports configured for 9, 18, or 36 bits is set by 8 initialization attributes (INITP\_00 through INITP\_07) of 64 hex values for a total of 2048 bits.

If any INIT\_xx or INITP\_xx attribute is not specified, it is configured as zeros. Partial Strings are padded with zeros to the left.

#### Initializing the Output Register of a Dual-Port RAMB16

In Spartan-3A, each bit in an output register can be initialized at power on (when GSR is high) to either a 0 or 1. In addition, the initial state specified for power on can be different than the state that results from assertion of a set/reset. Four properties control initialization of the output register for a dual-port RAMB16: INIT\_A, INIT\_B, SRVAL\_A, and SRVAL\_B. The INIT\_A attribute specifies the output register value at power on for Port A and the INIT\_B attribute specifies the value for Port B. You can use the SRVAL\_A attribute to define the state resulting from assertion of the SSR (set/reset) input on Port A. You can use the SRVAL\_B attribute to define the state resulting from assertion of the SSR input on Port B.

The INIT\_A, INIT\_B, SRVAL\_A, and SRVAL\_B attributes specify the initialization value as a hexadecimal String. The value is dependent upon the port width. For example, for a RAMB16\_S1\_S4 with Port A width equal to 1 and Port B width equal to 4, the Port A output register contains 1 bit and the Port B output register contains 4 bits. Therefore, the INIT\_A or SRVAL\_A value can only be specified as a 1 or 0. For Port B, the output register contains 4 bits. In this case, you can use INIT\_B or SRVAL\_B to specify a hexadecimal value from 0 through F to initialize the 4 bits of the output register.

For those ports that include parity bits, the parity portion of the output register is specified in the high order bit position of the INIT\_A, INIT\_B, SRVAL\_A, or SRVAL\_B value.

The INIT and SRVAL attributes default to zero if they are not set by you.

#### Write Mode Selection

The WRITE\_MODE\_A attribute controls the memory and output contents of Port A for a dual-port RAMB16. The WRITE\_MODE\_B attribute does the same for Port B. By default, both WRITE\_MODE\_A and WRITE\_MODE\_B are set to WRITE\_FIRST. This means that input is read, written to memory, and then passed to output. You can set the write mode for Port A and Port B to READ\_FIRST to read the memory contents, pass the memory contents to the outputs, and then write the input to memory. Or, you can set the write mode to NO\_CHANGE to have the input written to memory without changing the output. The "Port A and Port B Conflict Resolution" section describes how read/write conflicts are resolved when both Port A and Port B are attempting to read/write to the same memory cells.

#### Port A and Port B Conflict Resolution

Spartan-3A block SelectRAM is True Dual-Port RAM that allows both ports to simultaneously access the same memory cell. When one port writes to a given memory cell, the other port must not address that memory cell (for a write or a read) within the clock-to-clock setup window.

The following tables summarize the collision detection behavior of the dual-port RAMB16 based on the WRITE\_MODE\_A and WRITE\_MODE\_B settings.

*WRITE\_MODE\_A=NO\_CHANGE and WRITE\_MODE\_B=NO\_CHANGE*

WEA	WEB	CLKA	CLKB	DIA	DIB	DIPA	DIPB	DOA	DOB	DOPA	DOPB	Data RAM	Parity Ram
0	0	↑	↑	DIA	DIB	DIPA	DIPB	RAM	RAM	RAM	RAM	No Change	No Change
1	0	↑	↑	DIA	DIB	DIPA	DIPB	No Change	X	No Change	X	DIA	DIPA
0	1	↑	↑	DIA	DIB	DIPA	DIPB	X	No Change	X	No Change	DIB	DIPB
1	1	↑	↑	DIA	DIB	DIPA	DIPB	No Change	No Change	No Change	No Change	X	X

*WRITE\_MODE\_A=READ\_FIRST and WRITE\_MODE\_B=READ\_FIRST*

WEA	WEB	CLKA	CLKB	DIA	DIB	DIPA	DIPB	DOA	DOB	DOPA	DOPB	Data RAM	Parity Ram
0	0	↑	↑	DIA	DIB	DIPA	DIPB	RAM	RAM	RAM	RAM	No Change	No Change
1	0	↑	↑	DIA	DIB	DIPA	DIPB	RAM	RAM	RAM	RAM	DIA	DIPA
0	1	↑	↑	DIA	DIB	DIPA	DIPB	RAM	RAM	RAM	RAM	DIB	DIPB
1	1	↑	↑	DIA	DIB	DIPA	DIPB	RAM	RAM	RAM	RAM	X	X

*WRITE\_MODE\_A= WRITE\_FIRST and WRITE\_MODE\_B=WRITE\_FIRST*

WEA	WEB	CLKA	CLKB	DIA	DIB	DIPA	DIPB	DOA	DOB	DOPA	DOPB	Data RAM	Parity Ram
0	0	↑	↑	DIA	DIB	DIPA	DIPB	RAM	RAM	RAM	RAM	No Change	No Change
1	0	↑	↑	DIA	DIB	DIPA	DIPB	DIA	X	DIPA	X	DIA	DIPA
0	1	↑	↑	DIA	DIB	DIPA	DIPB	X	DIB	X	DIPB	DIB	DIPB
1	1	↑	↑	DIA	DIB	DIPA	DIPB	X	X	X	X	X	X

*WRITE\_MODE\_A=NO\_CHANGE and WRITE\_MODE\_B=READ\_FIRST*

WEA	WEB	CLKA	CLKB	DIA	DIB	DIPA	DIPB	DOA	DOB	DOPA	DOPB	Data RAM	Parity Ram
0	0	↑	↑	DIA	DIB	DIPA	DIPB	RAM	RAM	RAM	RAM	No Change	No Change
1	0	↑	↑	DIA	DIB	DIPA	DIPB	No Change	X	No Change	X	DIA	DIPA
0	1	↑	↑	DIA	DIB	DIPA	DIPB	RAM	RAM	RAM	RAM	DIB	DIPB
1	1	↑	↑	DIA	DIB	DIPA	DIPB	No Change	X	No Change	X	DIB	DIPB

*WRITE\_MODE\_A=NO\_CHANGE and WRITE\_MODE\_B=WRITE\_FIRST*

WEA	WEB	CLKA	CLKB	DIA	DIB	DIPA	DIPB	DOA	DOB	DOPA	DOPB	Data RAM	Parity Ram
0	0	↑	↑	DIA	DIB	DIPA	DIPB	RAM	RAM	RAM	RAM	No Change	No Change
1	0	↑	↑	DIA	DIB	DIPA	DIPB	No Change	X	No Change	X	DIA	DIPA



WEA	WEB	CLKA	CLKB	DIA	DIB	DIPA	DIPB	DOA	DOB	DOPA	DOPB	Data RAM	Parity Ram
0	1	↑	↑	DIA	DIB	DIPA	DIPB	X	DIB	X	DIPB	DIB	DIPB
1	1	↑	↑	DIA	DIB	DIPA	DIPB	No Change	X	No Change	X	X	X

*WRITE\_MODE\_A=READ\_FIRST and WRITE\_MODE\_B=WRITE\_FIRST*

WEA	WEB	CLKA	CLKB	DIA	DIB	DIPA	DIPB	DOA	DOB	DOPA	DOPB	Data RAM	Parity Ram
0	0	↑	↑	DIA	DIB	DIPA	DIPB	RAM	RAM	RAM	RAM	No Change	No Change
1	0	↑	↑	DIA	DIB	DIPA	DIPB	RAM	RAM	RAM	RAM	DIA	DIPA
0	1	↑	↑	DIA	DIB	DIPA	DIPB	X	DIB	X	DIPB	DIB	DIPB
1	1	↑	↑	DIA	DIB	DIPA	DIPB	X	DIB	X	DIPB	DIA	DIPA

## Design Entry Method

This design element can be used in schematics.

## Available Attributes

Attribute	Type	Allowed Values	Default	Description
INIT_00 To INIT_3F	Binary/Hexadecimal	Any	All zeros	Specifies the initial contents of the data portion of the RAM array.
INIT_A	Binary/Hexadecimal	Any	All zeros	Identifies the initial value of the DOA/DOB output port after completing configuration. For Type, the bit width is dependent on the width of the A or B port of the RAM.
INIT_B	Binary/Hexadecimal	Any	All zeros	Identifies the initial value of the DOA/DOB output port after completing configuration. For Type, the bit width is dependent on the width of the A or B port of the RAM.
INITP_00 To INITP_07	Binary/Hexadecimal	Any	All zeros	Specifies the initial contents of the parity portion of the RAM array.
SIM_COLLISION_CHECK	String	"ALL", "NONE", "WARNING", or "GENERATE_X_ONLY"	"ALL"	Specifies the behavior during simulation in the event of a data collision (data being read or written to the same address from both ports of the Ram simultaneously. "ALL" issues a warning to simulator console and generate an X or all unknown data due to the collision. This is the recommended setting. "WARNING" generates a warning only and "GENERATE_X_ONLY" generates an X for unknown data but won't output the occurrence to the simulation console. "NONE" completely ignores the error. It is suggested to only change this attribute if you can ensure the data generated during a collision is discarded.
SRVAL_A	Binary/Hexadecimal	Any	All zeros	Allows the individual selection of whether the DOA/DOB output port sets (go to a one) or reset (go to a zero) upon the assertion of the RSTA pin. For Type, the bit width is dependent on the width of the A port of the RAM.

Attribute	Type	Allowed Values	Default	Description
SRVAL_B	Binary/Hexadecimal	Any	All zeros	Allows the individual selection of whether the DOA/DOB output port sets (go to a one) or reset (go to a zero) upon the assertion of the RSTB pin. For Type, the bit width is dependent on the width of the B port of the RAM.
WRITE_MODE_A	String	"WRITE_FIRST", "READ_FIRST" or "NO_CHANGE"	"WRITE_FIRST"	Specifies the behavior of the DOA/DOB port upon a write command to the respected port. If set to WRITE_FIRST, the same port that is written to displays the contents of the written data to the outputs upon completion of the operation. "READ_FIRST" displays the prior contents of the RAM to the output port prior to writing the new data. "NO_CHANGE" keeps the previous value on the output port and won't update the output port upon a write command. This is the suggested mode if not using the read data from a particular port of the RAM
WRITE_MODE_B	String	"WRITE_FIRST", "READ_FIRST" or "NO_CHANGE"	"WRITE_FIRST"	Specifies the behavior of the DOA/DOB port upon a write command to the respected port. If set to WRITE_FIRST, the same port that is written to displays the contents of the written data to the outputs upon completion of the operation. "READ_FIRST" displays the prior contents of the RAM to the output port prior to writing the new data. "NO_CHANGE" keeps the previous value on the output port and won't update the output port upon a write command. This is the suggested mode if not using the read data from a particular port of the RAM.

## For More Information

- See the [Spartan-3 User Guide](#).
- See the [Spartan-3 Data Sheets](#).

# RAMB16\_S1\_S2

Primitive: 16K-bit Data and 2K-bit Parity Dual-Port Synchronous Block RAM with 1-bit and 2-bit Ports



## Introduction

This design element is a dual-ported dedicated random access memory block with synchronous write capability. Each block RAM port has 16384 bits of data memory. Ports configured as 9, 18, or 36-bits wide have an additional 2048 bits of parity memory. Each port is independent of the other while accessing the same set of 16384 data memory cells. Each port is independently configured to a specific data width. The possible port and cell configurations for this element are listed under "Port Descriptions."

## Logic Table

Truth Table A

Inputs								Outputs			
GSR	ENA	SSRA	WEA	CLKA	ADDRA	DIA	DIPA	DOA	DOPA	RAM Contents	
										Data RAM	Parity RAM
1	X	X	X	X	X	X	X	INIT_A	INIT_A	No Change	No Change
0	0	X	X	X	X	X	X	No Change	No Change	No Change	No Change
0	1	1	0	↑	X	X	X	SRVAL_A	SRVAL_A	No Change	No Change
0	1	1	1	↑	addr	data	pdata	SRVAL_A	SRVAL_A	RAM(addr) =>data	RAM(addr) =>pdata
0	1	0	0	↑	addr	X	X	RAM(addr)	RAM(addr)	No Change	No Change

Inputs								Outputs			
GSR	ENA	SSRA	WEA	CLKA	ADDRA	DIA	DIPA	DOA	DOPA	RAM Contents	
										Data RAM	Parity RAM
0	1	0	1	↑	addr	data	pdata	No Change1, RAM (addr)2, data3	No Change1, RAM (addr)2, pdata3	RAM(addr) =>data	RAM(addr) =>pdata

GSR=Global Set Reset  
 INIT\_A=Value specified by the INIT\_A attribute for output register. Default is all zeros.  
 SRVAL\_A=register value.  
 addr=RAM address.  
 RAM(addr)=RAM contents at address ADDR.  
 data=RAM input data.  
 pdata=RAM parity data.  
 1WRITE\_MODE\_A=NO\_CHANGE.  
 2WRITE\_MODE\_A=READ\_FIRST.  
 3WRITE\_MODE\_A=WRITE\_FIRST.

Truth Table B

Inputs								Outputs			
GSR	ENB	SSRB	WEB	CLKB	ADDRB	DIB	DIPB	DOB	DOPB	RAM Contents	
										Data RAM	Parity RAM
1	X	X	X	X	X	X	X	INIT_B	INIT_B	No Change	No Change
0	0	X	X	X	X	X	X	No Change	No Change	No Change	No Change
0	1	1	0	↑	X	X	X	SRVAL_B	SRVAL_B	No Change	No Change
0	1	1	1	↑	addr	data	pdata	SRVAL_B	SRVAL_B	RAM(addr) =>data	RAM(addr) =>pdata
0	1	0	0	↑	addr	X	X	RAM(addr)	RAM(addr)	No Change	No Change
0	1	0	1	↑	addr	data	pdata	No Change1, RAM (addr)2, data3	No Change1, RAM (addr)2, pdata3	RAM(addr)2	RAM(addr) =>pdata

GSR=Global Set Reset.  
 INIT\_B=Value specified by the INIT\_B attribute for output registers. Default is all zeros.  
 SRVAL\_B=register value.  
 addr=RAM address.  
 RAM(addr)=RAM contents at address ADDR.  
 data=RAM input data.  
 pdata=RAM parity data.  
 1WRITE\_MODE\_B=NO\_CHANGE.  
 2WRITE\_MODE\_B=READ\_FIRST.  
 3WRITE\_MODE\_B=WRITE\_FIRST.

## Port Descriptions

Port A						Port B				
Design Element	Data Cells(a)	Parity Cells(a)	Address Bus	Data Bus	Parity Bus	Data Cells(a)	Parity Cells(a)	Address Bus	Data Bus	Parity Bus
RAMB16_S1_S2	16384 x 1	-	(13:0)	(0:0)	-	8192 x 2	-	(12:0)	(1:0)	-
(a)Depth x Width										

Each port is fully synchronous with independent clock pins. All Port A input pins have setup time referenced to the CLKA pin and its data output bus DOA has a clock-to-out time referenced to the CLKA. All Port B input pins have setup time referenced to the CLKB pin and its data output bus DOB has a clock-to-out time referenced to the CLKB. The enable ENA pin controls read, write, and reset for Port A. When ENA is Low, no data is written and the outputs (DOA and DOPA) retain the last state. When ENA is High and reset (SSRA) is High, DOA and DOPA are set to SRVAL\_A during the Low-to-High clock (CLKA) transition; if write enable (WEA) is High, the memory contents reflect the data at DIA and DIPA. When ENA is High and WEA is Low, the data stored in the RAM address (ADDRA) is read during the Low-to-High clock transition. By default, WRITE\_MODE\_A=WRITE\_FIRST, when ENA and WEA are High, the data on the data inputs (DIA and DIPA) is loaded into the word selected by the write address (ADDRA) during the Low-to-High clock transition and the data outputs (DOA and DOPA) reflect the selected (addressed) word.

The enable ENB pin controls read, write, and reset for Port B. When ENB is Low, no data is written and the outputs (DOB and DOPB) retain the last state. When ENB is High and reset (SSRB) is High, DOB and DOPB are set to SRVAL\_B during the Low-to-High clock (CLKB) transition; if write enable (WEB) is High, the memory contents reflect the data at DIB and DIPB. When ENB is High and WEB is Low, the data stored in the RAM address (ADDRB) is read during the Low-to-High clock transition. By default, WRITE\_MODE\_B=WRITE\_FIRST, when ENB and WEB are High, the data on the data inputs (DIB and IPB) are loaded into the word selected by the write address (ADDRB) during the Low-to-High clock transition and the data outputs (DOB and DOPB) reflect the selected (addressed) word. The above descriptions assume active High control pins (ENA, WEA, SSRA, CLKA, ENB, WEB, SSRB, and CLKB). However, the active level can be changed by placing an inverter on the port. Any inverter placed on a RAMB16 port is absorbed into the block and does not use a CLB resource.

### Address Mapping

Each port accesses the same set of 18432 memory cells using an addressing scheme that is dependent on the width of the port. For all port widths, 16384 memory cells are available for data as shown in the “Port Address Mapping for Data” table below. For 9-, 18-, and 36-bit wide ports, 2408 parity memory cells are also available as shown in “Port Address Mapping for Parity” table below. The physical RAM location that is addressed for a particular width is determined from the following formula.

$$\text{Start} = ((\text{ADDR port} + 1) * (\text{Widthport})) - 1$$

$$\text{End} = (\text{ADDRport}) * (\text{Widthport})$$

The following tables show address mapping for each port width.

### Port Address Mapping for Data

Data Width	Port Data Addresses	31	30	29	28	27	26	25	24	23	22	21	20	19	18	17	16	15	14	13	12	11	10	9	8	7	6	5	4	3	2	1	0
1	16384	<--																															
2	8192	<--	15	14	13	12	11	10	9	8	7	6	5	4	3	2	1	0															
4	4096	<--	7		6			5		4			3			2								1					0				
8	2048	<--	3					2					1												0								
16	1024	<--	1										0																				
32	512	<--	0																														

### Port Address Mapping for Parity

Parity Width	Port Parity Addresses																
1	2048	<-----	3					2					1				0
2	1024	<-----	1										0				
4	512	<-----	0														

#### Initializing Memory Contents of a Dual-Port RAMB16

You can use the INIT\_xx attributes to specify an initialization value for the memory contents of a RAMB16 during device configuration. The initialization of each RAMB16\_Sm\_Sn is set by 64 initialization attributes (INIT\_00 through INIT\_3F) of 64 hex values for a total of 16384 bits.

You can use the INITP\_xx attributes to specify an initial value for the parity memory during device configuration or assertion. The initialization of the parity memory for ports configured for 9, 18, or 36 bits is set by 8 initialization attributes (INITP\_00 through INITP\_07) of 64 hex values for a total of 2048 bits.

If any INIT\_xx or INITP\_xx attribute is not specified, it is configured as zeros. Partial Strings are padded with zeros to the left.

#### Initializing the Output Register of a Dual-Port RAMB16

In Spartan-3A, each bit in an output register can be initialized at power on (when GSR is high) to either a 0 or 1. In addition, the initial state specified for power on can be different than the state that results from assertion of a set/reset. Four properties control initialization of the output register for a dual-port RAMB16: INIT\_A, INIT\_B, SRVAL\_A, and SRVAL\_B. The INIT\_A attribute specifies the output register value at power on for Port A and the INIT\_B attribute specifies the value for Port B. You can use the SRVAL\_A attribute to define the state resulting from assertion of the SSR (set/reset) input on Port A. You can use the SRVAL\_B attribute to define the state resulting from assertion of the SSR input on Port B.

The INIT\_A, INIT\_B, SRVAL\_A, and SRVAL\_B attributes specify the initialization value as a hexadecimal String. The value is dependent upon the port width. For example, for a RAMB16\_S1\_S4 with Port A width equal to 1 and Port B width equal to 4, the Port A output register contains 1 bit and the Port B output register contains 4 bits. Therefore, the INIT\_A or SRVAL\_A value can only be specified as a 1 or 0. For Port B, the output register contains 4 bits. In this case, you can use INIT\_B or SRVAL\_B to specify a hexadecimal value from 0 through F to initialize the 4 bits of the output register.

For those ports that include parity bits, the parity portion of the output register is specified in the high order bit position of the INIT\_A, INIT\_B, SRVAL\_A, or SRVAL\_B value.

The INIT and SRVAL attributes default to zero if they are not set by you.

#### Write Mode Selection

The WRITE\_MODE\_A attribute controls the memory and output contents of Port A for a dual-port RAMB16. The WRITE\_MODE\_B attribute does the same for Port B. By default, both WRITE\_MODE\_A and WRITE\_MODE\_B are set to WRITE\_FIRST. This means that input is read, written to memory, and then passed to output. You can set the write mode for Port A and Port B to READ\_FIRST to read the memory contents, pass the memory contents to the outputs, and then write the input to memory. Or, you can set the write mode to NO\_CHANGE to have the input written to memory without changing the output. The "Port A and Port B Conflict Resolution" section describes how read/write conflicts are resolved when both Port A and Port B are attempting to read/write to the same memory cells.

#### Port A and Port B Conflict Resolution

Spartan-3A block SelectRAM is True Dual-Port RAM that allows both ports to simultaneously access the same memory cell. When one port writes to a given memory cell, the other port must not address that memory cell (for a write or a read) within the clock-to-clock setup window.

The following tables summarize the collision detection behavior of the dual-port RAMB16 based on the WRITE\_MODE\_A and WRITE\_MODE\_B settings.

*WRITE\_MODE\_A=NO\_CHANGE and WRITE\_MODE\_B=NO\_CHANGE*

WEA	WEB	CLKA	CLKB	DIA	DIB	DIPA	DIPB	DOA	DOB	DOPA	DOPB	Data RAM	Parity Ram
0	0	↑	↑	DIA	DIB	DIPA	DIPB	RAM	RAM	RAM	RAM	No Change	No Change
1	0	↑	↑	DIA	DIB	DIPA	DIPB	No Change	X	No Change	X	DIA	DIPA
0	1	↑	↑	DIA	DIB	DIPA	DIPB	X	No Change	X	No Change	DIB	DIPB
1	1	↑	↑	DIA	DIB	DIPA	DIPB	No Change	No Change	No Change	No Change	X	X

*WRITE\_MODE\_A=READ\_FIRST and WRITE\_MODE\_B=READ\_FIRST*

WEA	WEB	CLKA	CLKB	DIA	DIB	DIPA	DIPB	DOA	DOB	DOPA	DOPB	Data RAM	Parity Ram
0	0	↑	↑	DIA	DIB	DIPA	DIPB	RAM	RAM	RAM	RAM	No Change	No Change
1	0	↑	↑	DIA	DIB	DIPA	DIPB	RAM	RAM	RAM	RAM	DIA	DIPA
0	1	↑	↑	DIA	DIB	DIPA	DIPB	RAM	RAM	RAM	RAM	DIB	DIPB
1	1	↑	↑	DIA	DIB	DIPA	DIPB	RAM	RAM	RAM	RAM	X	X

*WRITE\_MODE\_A= WRITE\_FIRST and WRITE\_MODE\_B=WRITE\_FIRST*

WEA	WEB	CLKA	CLKB	DIA	DIB	DIPA	DIPB	DOA	DOB	DOPA	DOPB	Data RAM	Parity Ram
0	0	↑	↑	DIA	DIB	DIPA	DIPB	RAM	RAM	RAM	RAM	No Change	No Change
1	0	↑	↑	DIA	DIB	DIPA	DIPB	DIA	X	DIPA	X	DIA	DIPA
0	1	↑	↑	DIA	DIB	DIPA	DIPB	X	DIB	X	DIPB	DIB	DIPB
1	1	↑	↑	DIA	DIB	DIPA	DIPB	X	X	X	X	X	X

*WRITE\_MODE\_A=NO\_CHANGE and WRITE\_MODE\_B=READ\_FIRST*

WEA	WEB	CLKA	CLKB	DIA	DIB	DIPA	DIPB	DOA	DOB	DOPA	DOPB	Data RAM	Parity Ram
0	0	↑	↑	DIA	DIB	DIPA	DIPB	RAM	RAM	RAM	RAM	No Change	No Change
1	0	↑	↑	DIA	DIB	DIPA	DIPB	No Change	X	No Change	X	DIA	DIPA
0	1	↑	↑	DIA	DIB	DIPA	DIPB	RAM	RAM	RAM	RAM	DIB	DIPB
1	1	↑	↑	DIA	DIB	DIPA	DIPB	No Change	X	No Change	X	DIB	DIPB

*WRITE\_MODE\_A=NO\_CHANGE and WRITE\_MODE\_B=WRITE\_FIRST*

WEA	WEB	CLKA	CLKB	DIA	DIB	DIPA	DIPB	DOA	DOB	DOPA	DOPB	Data RAM	Parity Ram
0	0	↑	↑	DIA	DIB	DIPA	DIPB	RAM	RAM	RAM	RAM	No Change	No Change
1	0	↑	↑	DIA	DIB	DIPA	DIPB	No Change	X	No Change	X	DIA	DIPA
0	1	↑	↑	DIA	DIB	DIPA	DIPB	X	DIB	X	DIPB	DIB	DIPB
1	1	↑	↑	DIA	DIB	DIPA	DIPB	No Change	X	No Change	X	X	X

*WRITE\_MODE\_A=READ\_FIRST and WRITE\_MODE\_B=WRITE\_FIRST*

WEA	WEB	CLKA	CLKB	DIA	DIB	DIPA	DIPB	DOA	DOB	DOPA	DOPB	Data RAM	Parity Ram
0	0	↑	↑	DIA	DIB	DIPA	DIPB	RAM	RAM	RAM	RAM	No Change	No Change
1	0	↑	↑	DIA	DIB	DIPA	DIPB	RAM	RAM	RAM	RAM	DIA	DIPA
0	1	↑	↑	DIA	DIB	DIPA	DIPB	X	DIB	X	DIPB	DIB	DIPB
1	1	↑	↑	DIA	DIB	DIPA	DIPB	X	DIB	X	DIPB	DIA	DIPA

## Design Entry Method

This design element can be used in schematics.

## Available Attributes

Attribute	Type	Allowed Values	Default	Description
INIT_00 To INIT_3F	Binary/Hexadecimal	Any	All zeros	Specifies the initial contents of the data portion of the RAM array.
INIT_A	Binary/Hexadecimal	Any	All zeros	Identifies the initial value of the DOA/DOB output port after completing configuration. For Type, the bit width is dependent on the width of the A or B port of the RAM.
INIT_B	Binary/Hexadecimal	Any	All zeros	Identifies the initial value of the DOA/DOB output port after completing configuration. For Type, the bit width is dependent on the width of the A or B port of the RAM.
INITP_00 To INITP_07	Binary/Hexadecimal	Any	All zeros	Specifies the initial contents of the parity portion of the RAM array.
SIM_COLLISION_CHECK	String	"ALL", "NONE", "WARNING", or "GENERATE_X_ONLY"	"ALL"	Specifies the behavior during simulation in the event of a data collision (data being read or written to the same address from both ports of the Ram simultaneously. "ALL" issues a warning to simulator console and generate an X or all unknown data due to the collision. This is the recommended setting. "WARNING" generates a warning only and "GENERATE_X_ONLY" generates an X for unknown data but won't output the occurrence to the simulation console. "NONE" completely ignores the error. It is suggested to only change this attribute if you can ensure the data generated during a collision is discarded.



Attribute	Type	Allowed Values	Default	Description
SRVAL_A	Binary/Hexadecimal	Any	All zeros	Allows the individual selection of whether the DOA/DOB output port sets (go to a one) or reset (go to a zero) upon the assertion of the RSTA pin. For Type, the bit width is dependent on the width of the A port of the RAM.
SRVAL_B	Binary/Hexadecimal	Any	All zeros	Allows the individual selection of whether the DOA/DOB output port sets (go to a one) or reset (go to a zero) upon the assertion of the RSTB pin. For Type, the bit width is dependent on the width of the B port of the RAM.
WRITE_MODE_A	String	"WRITE_FIRST", "READ_FIRST" or "NO_CHANGE"	"WRITE_FIRST"	Specifies the behavior of the DOA/DOB port upon a write command to the respected port. If set to WRITE_FIRST, the same port that is written to displays the contents of the written data to the outputs upon completion of the operation. "READ_FIRST" displays the prior contents of the RAM to the output port prior to writing the new data. "NO_CHANGE" keeps the previous value on the output port and won't update the output port upon a write command. This is the suggested mode if not using the read data from a particular port of the RAM
WRITE_MODE_B	String	"WRITE_FIRST", "READ_FIRST" or "NO_CHANGE"	"WRITE_FIRST"	Specifies the behavior of the DOA/DOB port upon a write command to the respected port. If set to WRITE_FIRST, the same port that is written to displays the contents of the written data to the outputs upon completion of the operation. "READ_FIRST" displays the prior contents of the RAM to the output port prior to writing the new data. "NO_CHANGE" keeps the previous value on the output port and won't update the output port upon a write command. This is the suggested mode if not using the read data from a particular port of the RAM.

## For More Information

- See the [Spartan-3 User Guide](#).
- See the [Spartan-3 Data Sheets](#).

# RAMB16\_S1\_S36

Primitive: 16K-bit Data and 2K-bit Parity Dual-Port Synchronous Block RAM with 1-bit and 36-bit Ports

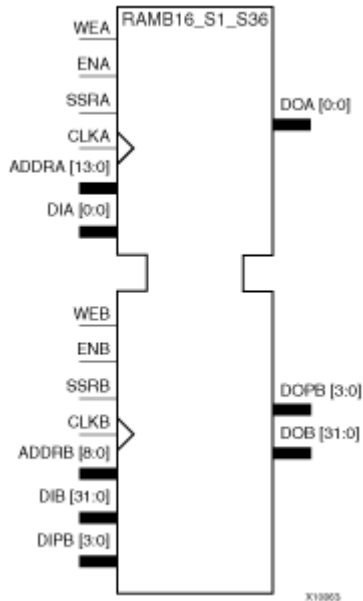

## Introduction

This design element is a dual-ported dedicated random access memory block with synchronous write capability. Each block RAM port has 16384 bits of data memory. Ports configured as 9, 18, or 36-bits wide have an additional 2048 bits of parity memory. Each port is independent of the other while accessing the same set of 16384 data memory cells. Each port is independently configured to a specific data width. The possible port and cell configurations for this element are listed under "Port Descriptions."

## Logic Table

Truth Table A

Inputs								Outputs			
GSR	ENA	SSRA	WEA	CLKA	ADDR_A	DIA	DIPA	DOA	DOPA	RAM Contents	
										Data RAM	Parity RAM
1	X	X	X	X	X	X	X	INIT_A	INIT_A	No Change	No Change
0	0	X	X	X	X	X	X	No Change	No Change	No Change	No Change
0	1	1	0	↑	X	X	X	SRVAL_A	SRVAL_A	No Change	No Change
0	1	1	1	↑	addr	data	pdata	SRVAL_A	SRVAL_A	RAM(addr) =>data	RAM(addr) =>pdata
0	1	0	0	↑	addr	X	X	RAM(addr)	RAM(addr)	No Change	No Change

Inputs								Outputs			
GSR	ENA	SSRA	WEA	CLKA	ADDRA	DIA	DIPA	DOA	DOPA	RAM Contents	
										Data RAM	Parity RAM
0	1	0	1	↑	addr	data	pdata	No Change1, RAM (addr)2, data3	No Change1, RAM (addr)2, pdata3	RAM(addr) =>data	RAM(addr) =>pdata

GSR=Global Set Reset  
 INIT\_A=Value specified by the INIT\_A attribute for output register. Default is all zeros.  
 SRVAL\_A=register value.  
 addr=RAM address.  
 RAM(addr)=RAM contents at address ADDR.  
 data=RAM input data.  
 pdata=RAM parity data.  
 1WRITE\_MODE\_A=NO\_CHANGE.  
 2WRITE\_MODE\_A=READ\_FIRST.  
 3WRITE\_MODE\_A=WRITE\_FIRST.

Truth Table B

Inputs								Outputs			
GSR	ENB	SSRB	WEB	CLKB	ADDRB	DIB	DIPB	DOB	DOPB	RAM Contents	
										Data RAM	Parity RAM
1	X	X	X	X	X	X	X	INIT_B	INIT_B	No Change	No Change
0	0	X	X	X	X	X	X	No Change	No Change	No Change	No Change
0	1	1	0	↑	X	X	X	SRVAL_B	SRVAL_B	No Change	No Change
0	1	1	1	↑	addr	data	pdata	SRVAL_B	SRVAL_B	RAM(addr) =>data	RAM(addr) =>pdata
0	1	0	0	↑	addr	X	X	RAM(addr)	RAM(addr)	No Change	No Change
0	1	0	1	↑	addr	data	pdata	No Change1, RAM (addr)2, data3	No Change1, RAM (addr)2, pdata3	RAM(addr)2	RAM(addr) =>pdata

GSR=Global Set Reset.  
 INIT\_B=Value specified by the INIT\_B attribute for output registers. Default is all zeros.  
 SRVAL\_B=register value.  
 addr=RAM address.  
 RAM(addr)=RAM contents at address ADDR.  
 data=RAM input data.  
 pdata=RAM parity data.  
 1WRITE\_MODE\_B=NO\_CHANGE.  
 2WRITE\_MODE\_B=READ\_FIRST.

See the ISE 10.1 User Guide for Schematic Designs

## Port Descriptions

Port A						Port B				
Component	Data Cells(a)	Parity Cells(a)	Address Bus	Data Bus	Parity Bus	Data Cells(a)	Parity Cells(a)	Address Bus	Data Bus	Parity Bus
RAMB16_S1_S36	16384 x 1	-	(13:0)	(0:0)	-	512 x 32	512 x 4	(8:0)	(31:0)	(3:0)
(a) Depth x Width										

Each port is fully synchronous with independent clock pins. All Port A input pins have setup time referenced to the CLKA pin and its data output bus DOA has a clock-to-out time referenced to the CLKA. All Port B input pins have setup time referenced to the CLKB pin and its data output bus DOB has a clock-to-out time referenced to the CLKB. The enable ENA pin controls read, write, and reset for Port A. When ENA is Low, no data is written and the outputs (DOA and DOPA) retain the last state. When ENA is High and reset (SSRA) is High, DOA and DOPA are set to SRVAL\_A during the Low-to-High clock (CLKA) transition; if write enable (WEA) is High, the memory contents reflect the data at DIA and DIPA. When ENA is High and WEA is Low, the data stored in the RAM address (ADDRA) is read during the Low-to-High clock transition. By default, WRITE\_MODE\_A=WRITE\_FIRST, when ENA and WEA are High, the data on the data inputs (DIA and DIPA) is loaded into the word selected by the write address (ADDRA) during the Low-to-High clock transition and the data outputs (DOA and DOPA) reflect the selected (addressed) word.

The enable ENB pin controls read, write, and reset for Port B. When ENB is Low, no data is written and the outputs (DOB and DOPB) retain the last state. When ENB is High and reset (SSRB) is High, DOB and DOPB are set to SRVAL\_B during the Low-to-High clock (CLKB) transition; if write enable (WEB) is High, the memory contents reflect the data at DIB and DIPB. When ENB is High and WEB is Low, the data stored in the RAM address (ADDRB) is read during the Low-to-High clock transition. By default, WRITE\_MODE\_B=WRITE\_FIRST, when ENB and WEB are High, the data on the data inputs (DIB and IPB) are loaded into the word selected by the write address (ADDRB) during the Low-to-High clock transition and the data outputs (DOB and DOPB) reflect the selected (addressed) word. The above descriptions assume active High control pins (ENA, WEA, SSRA, CLKA, ENB, WEB, SSRB, and CLKB). However, the active level can be changed by placing an inverter on the port. Any inverter placed on a RAMB16 port is absorbed into the block and does not use a CLB resource.

### Address Mapping

Each port accesses the same set of 18432 memory cells using an addressing scheme that is dependent on the width of the port. For all port widths, 16384 memory cells are available for data as shown in the "Port Address Mapping for Data" table below. For 9-, 18-, and 36-bit wide ports, 2408 parity memory cells are also available as shown in "Port Address Mapping for Parity" table below. The physical RAM location that is addressed for a particular width is determined from the following formula.

$$\text{Start} = ((\text{ADDR port} + 1) * (\text{Widthport})) - 1$$

$$\text{End} = (\text{ADDRport}) * (\text{Widthport})$$

The following tables show address mapping for each port width.

### Port Address Mapping for Data

Data Width	Port Data Addresses
1	16384 <-- 31 30 29 28 27 26 25 24 23 22 21 20 19 18 17 16 15 14 13 12 11 10 9 8 7 6 5 4 3 2 1 0
2	8192 <-- 15 14 13 12 11 10 9 8 7 6 5 4 3 2 1 0
4	4096 <-- 7 6 5 4 3 2 1 0
8	2048 <-- 3 2 1 0
16	1024 <-- 1 0
32	512 <-- 0

### Port Address Mapping for Parity

Parity Width	Port Parity Addresses																
1	2048	<-----	3					2					1				0
2	1024	<-----	1										0				
4	512	<-----	0														

#### Initializing Memory Contents of a Dual-Port RAMB16

You can use the INIT\_xx attributes to specify an initialization value for the memory contents of a RAMB16 during device configuration. The initialization of each RAMB16\_Sm\_Sn is set by 64 initialization attributes (INIT\_00 through INIT\_3F) of 64 hex values for a total of 16384 bits.

You can use the INITP\_xx attributes to specify an initial value for the parity memory during device configuration or assertion. The initialization of the parity memory for ports configured for 9, 18, or 36 bits is set by 8 initialization attributes (INITP\_00 through INITP\_07) of 64 hex values for a total of 2048 bits.

If any INIT\_xx or INITP\_xx attribute is not specified, it is configured as zeros. Partial Strings are padded with zeros to the left.

#### Initializing the Output Register of a Dual-Port RAMB16

In Spartan-3A, each bit in an output register can be initialized at power on (when GSR is high) to either a 0 or 1. In addition, the initial state specified for power on can be different than the state that results from assertion of a set/reset. Four properties control initialization of the output register for a dual-port RAMB16: INIT\_A, INIT\_B, SRVAL\_A, and SRVAL\_B. The INIT\_A attribute specifies the output register value at power on for Port A and the INIT\_B attribute specifies the value for Port B. You can use the SRVAL\_A attribute to define the state resulting from assertion of the SSR (set/reset) input on Port A. You can use the SRVAL\_B attribute to define the state resulting from assertion of the SSR input on Port B.

The INIT\_A, INIT\_B, SRVAL\_A, and SRVAL\_B attributes specify the initialization value as a hexadecimal String. The value is dependent upon the port width. For example, for a RAMB16\_S1\_S4 with Port A width equal to 1 and Port B width equal to 4, the Port A output register contains 1 bit and the Port B output register contains 4 bits. Therefore, the INIT\_A or SRVAL\_A value can only be specified as a 1 or 0. For Port B, the output register contains 4 bits. In this case, you can use INIT\_B or SRVAL\_B to specify a hexadecimal value from 0 through F to initialize the 4 bits of the output register.

For those ports that include parity bits, the parity portion of the output register is specified in the high order bit position of the INIT\_A, INIT\_B, SRVAL\_A, or SRVAL\_B value.

The INIT and SRVAL attributes default to zero if they are not set by you.

#### Write Mode Selection

The WRITE\_MODE\_A attribute controls the memory and output contents of Port A for a dual-port RAMB16. The WRITE\_MODE\_B attribute does the same for Port B. By default, both WRITE\_MODE\_A and WRITE\_MODE\_B are set to WRITE\_FIRST. This means that input is read, written to memory, and then passed to output. You can set the write mode for Port A and Port B to READ\_FIRST to read the memory contents, pass the memory contents to the outputs, and then write the input to memory. Or, you can set the write mode to NO\_CHANGE to have the input written to memory without changing the output. The "Port A and Port B Conflict Resolution" section describes how read/write conflicts are resolved when both Port A and Port B are attempting to read/write to the same memory cells.

#### Port A and Port B Conflict Resolution

Spartan-3A block SelectRAM is True Dual-Port RAM that allows both ports to simultaneously access the same memory cell. When one port writes to a given memory cell, the other port must not address that memory cell (for a write or a read) within the clock-to-clock setup window.

The following tables summarize the collision detection behavior of the dual-port RAMB16 based on the WRITE\_MODE\_A and WRITE\_MODE\_B settings.

*WRITE\_MODE\_A=NO\_CHANGE and WRITE\_MODE\_B=NO\_CHANGE*

WEA	WEB	CLKA	CLKB	DIA	DIB	DIPA	DIPB	DOA	DOB	DOPA	DOPB	Data RAM	Parity Ram
0	0	↑	↑	DIA	DIB	DIPA	DIPB	RAM	RAM	RAM	RAM	No Change	No Change
1	0	↑	↑	DIA	DIB	DIPA	DIPB	No Change	X	No Change	X	DIA	DIPA
0	1	↑	↑	DIA	DIB	DIPA	DIPB	X	No Change	X	No Change	DIB	DIPB
1	1	↑	↑	DIA	DIB	DIPA	DIPB	No Change	No Change	No Change	No Change	X	X

*WRITE\_MODE\_A=READ\_FIRST and WRITE\_MODE\_B=READ\_FIRST*

WEA	WEB	CLKA	CLKB	DIA	DIB	DIPA	DIPB	DOA	DOB	DOPA	DOPB	Data RAM	Parity Ram
0	0	↑	↑	DIA	DIB	DIPA	DIPB	RAM	RAM	RAM	RAM	No Change	No Change
1	0	↑	↑	DIA	DIB	DIPA	DIPB	RAM	RAM	RAM	RAM	DIA	DIPA
0	1	↑	↑	DIA	DIB	DIPA	DIPB	RAM	RAM	RAM	RAM	DIB	DIPB
1	1	↑	↑	DIA	DIB	DIPA	DIPB	RAM	RAM	RAM	RAM	X	X

*WRITE\_MODE\_A= WRITE\_FIRST and WRITE\_MODE\_B=WRITE\_FIRST*

WEA	WEB	CLKA	CLKB	DIA	DIB	DIPA	DIPB	DOA	DOB	DOPA	DOPB	Data RAM	Parity Ram
0	0	↑	↑	DIA	DIB	DIPA	DIPB	RAM	RAM	RAM	RAM	No Change	No Change
1	0	↑	↑	DIA	DIB	DIPA	DIPB	DIA	X	DIPA	X	DIA	DIPA
0	1	↑	↑	DIA	DIB	DIPA	DIPB	X	DIB	X	DIPB	DIB	DIPB
1	1	↑	↑	DIA	DIB	DIPA	DIPB	X	X	X	X	X	X

*WRITE\_MODE\_A=NO\_CHANGE and WRITE\_MODE\_B=READ\_FIRST*

WEA	WEB	CLKA	CLKB	DIA	DIB	DIPA	DIPB	DOA	DOB	DOPA	DOPB	Data RAM	Parity Ram
0	0	↑	↑	DIA	DIB	DIPA	DIPB	RAM	RAM	RAM	RAM	No Change	No Change
1	0	↑	↑	DIA	DIB	DIPA	DIPB	No Change	X	No Change	X	DIA	DIPA
0	1	↑	↑	DIA	DIB	DIPA	DIPB	RAM	RAM	RAM	RAM	DIB	DIPB
1	1	↑	↑	DIA	DIB	DIPA	DIPB	No Change	X	No Change	X	DIB	DIPB

*WRITE\_MODE\_A=NO\_CHANGE and WRITE\_MODE\_B=WRITE\_FIRST*

WEA	WEB	CLKA	CLKB	DIA	DIB	DIPA	DIPB	DOA	DOB	DOPA	DOPB	Data RAM	Parity Ram
0	0	↑	↑	DIA	DIB	DIPA	DIPB	RAM	RAM	RAM	RAM	No Change	No Change
1	0	↑	↑	DIA	DIB	DIPA	DIPB	No Change	X	No Change	X	DIA	DIPA

WEA	WEB	CLKA	CLKB	DIA	DIB	DIPA	DIPB	DOA	DOB	DOPA	DOPB	Data RAM	Parity Ram
0	1	↑	↑	DIA	DIB	DIPA	DIPB	X	DIB	X	DIPB	DIB	DIPB
1	1	↑	↑	DIA	DIB	DIPA	DIPB	No Change	X	No Change	X	X	X

WRITE\_MODE\_A=READ\_FIRST and WRITE\_MODE\_B=WRITE\_FIRST

WEA	WEB	CLKA	CLKB	DIA	DIB	DIPA	DIPB	DOA	DOB	DOPA	DOPB	Data RAM	Parity Ram
0	0	↑	↑	DIA	DIB	DIPA	DIPB	RAM	RAM	RAM	RAM	No Change	No Change
1	0	↑	↑	DIA	DIB	DIPA	DIPB	RAM	RAM	RAM	RAM	DIA	DIPA
0	1	↑	↑	DIA	DIB	DIPA	DIPB	X	DIB	X	DIPB	DIB	DIPB
1	1	↑	↑	DIA	DIB	DIPA	DIPB	X	DIB	X	DIPB	DIA	DIPA

## Design Entry Method

This design element can be used in schematics.

## Available Attributes

Attribute	Type	Allowed Values	Default	Description
INIT_00 To INIT_3F	Binary/Hexadecimal	Any	All zeros	Specifies the initial contents of the data portion of the RAM array.
INIT_A	Binary/Hexadecimal	Any	All zeros	Identifies the initial value of the DOA/DOB output port after completing configuration. For Type, the bit width is dependent on the width of the A or B port of the RAM.
INIT_B	Binary/Hexadecimal	Any	All zeros	Identifies the initial value of the DOA/DOB output port after completing configuration. For Type, the bit width is dependent on the width of the A or B port of the RAM.
INITP_00 To INITP_07	Binary/Hexadecimal	Any	All zeros	Specifies the initial contents of the parity portion of the RAM array.
SIM_COLLISION_CHECK	String	"ALL", "NONE", "WARNING", or "GENERATE_X_ONLY"	"ALL"	Specifies the behavior during simulation in the event of a data collision (data being read or written to the same address from both ports of the Ram simultaneously. "ALL" issues a warning to simulator console and generate an X or all unknown data due to the collision. This is the recommended setting. "WARNING" generates a warning only and "GENERATE_X_ONLY" generates an X for unknown data but won't output the occurrence to the simulation console. "NONE" completely ignores the error. It is suggested to only change this attribute if you can ensure the data generated during a collision is discarded.

Attribute	Type	Allowed Values	Default	Description
SRVAL_A	Binary/Hexadecimal	Any	All zeros	Allows the individual selection of whether the DOA/DOB output port sets (go to a one) or reset (go to a zero) upon the assertion of the RSTA pin. For Type, the bit width is dependent on the width of the A port of the RAM.
SRVAL_B	Binary/Hexadecimal	Any	All zeros	Allows the individual selection of whether the DOA/DOB output port sets (go to a one) or reset (go to a zero) upon the assertion of the RSTB pin. For Type, the bit width is dependent on the width of the B port of the RAM.
WRITE_MODE_A	String	"WRITE_FIRST", "READ_FIRST" or "NO_CHANGE"	"WRITE_FIRST"	Specifies the behavior of the DOA/DOB port upon a write command to the respected port. If set to WRITE_FIRST, the same port that is written to displays the contents of the written data to the outputs upon completion of the operation. "READ_FIRST" displays the prior contents of the RAM to the output port prior to writing the new data. "NO_CHANGE" keeps the previous value on the output port and won't update the output port upon a write command. This is the suggested mode if not using the read data from a particular port of the RAM
WRITE_MODE_B	String	"WRITE_FIRST", "READ_FIRST" or "NO_CHANGE"	"WRITE_FIRST"	Specifies the behavior of the DOA/DOB port upon a write command to the respected port. If set to WRITE_FIRST, the same port that is written to displays the contents of the written data to the outputs upon completion of the operation. "READ_FIRST" displays the prior contents of the RAM to the output port prior to writing the new data. "NO_CHANGE" keeps the previous value on the output port and won't update the output port upon a write command. This is the suggested mode if not using the read data from a particular port of the RAM.

## For More Information

- See the [Spartan-3 User Guide](#).
- See the [Spartan-3 Data Sheets](#).



# RAMB16\_S1\_S4

Primitive: 16K-bit Data and 2K-bit Parity Dual-Port Synchronous Block RAM with 1-bit and 4-bit Ports



## Introduction

This design element is a dual-ported dedicated random access memory block with synchronous write capability. Each block RAM port has 16384 bits of data memory. Ports configured as 9, 18, or 36-bits wide have an additional 2048 bits of parity memory. Each port is independent of the other while accessing the same set of 16384 data memory cells. Each port is independently configured to a specific data width. The possible port and cell configurations for this element are listed under "Port Descriptions."

## Logic Table

Truth Table A

Inputs								Outputs			
GSR	ENA	SSRA	WEA	CLKA	ADDR_A	DIA	DIPA	DOA	DOPA	RAM Contents	
										Data RAM	Parity RAM
1	X	X	X	X	X	X	X	INIT_A	INIT_A	No Change	No Change
0	0	X	X	X	X	X	X	No Change	No Change	No Change	No Change
0	1	1	0	↑	X	X	X	SRVAL_A	SRVAL_A	No Change	No Change
0	1	1	1	↑	addr	data	pdata	SRVAL_A	SRVAL_A	RAM(addr) =>data	RAM(addr) =>pdata
0	1	0	0	↑	addr	X	X	RAM(addr)	RAM(addr)	No Change	No Change

Inputs								Outputs			
GSR	ENA	SSRA	WEA	CLKA	ADDRA	DIA	DIPA	DOA	DOPA	RAM Contents	
										Data RAM	Parity RAM
0	1	0	1	↑	addr	data	pdata	No Change1, RAM (addr)2, data3	No Change1, RAM (addr)2, pdata3	RAM(addr) =>data	RAM(addr) =>pdata

GSR=Global Set Reset  
 INIT\_A=Value specified by the INIT\_A attribute for output register. Default is all zeros.  
 SRVAL\_A=register value.  
 addr=RAM address.  
 RAM(addr)=RAM contents at address ADDR.  
 data=RAM input data.  
 pdata=RAM parity data.  
 1WRITE\_MODE\_A=NO\_CHANGE.  
 2WRITE\_MODE\_A=READ\_FIRST.  
 3WRITE\_MODE\_A=WRITE\_FIRST.

Truth Table B

Inputs								Outputs			
GSR	ENB	SSRB	WEB	CLKB	ADDRB	DIB	DIPB	DOB	DOPB	RAM Contents	
										Data RAM	Parity RAM
1	X	X	X	X	X	X	X	INIT_B	INIT_B	No Change	No Change
0	0	X	X	X	X	X	X	No Change	No Change	No Change	No Change
0	1	1	0	↑	X	X	X	SRVAL_B	SRVAL_B	No Change	No Change
0	1	1	1	↑	addr	data	pdata	SRVAL_B	SRVAL_B	RAM(addr) =>data	RAM(addr) =>pdata
0	1	0	0	↑	addr	X	X	RAM(addr)	RAM(addr)	No Change	No Change
0	1	0	1	↑	addr	data	pdata	No Change1, RAM (addr)2, data3	No Change1, RAM (addr)2, pdata3	RAM(addr)2	RAM(addr) =>pdata

GSR=Global Set Reset.  
 INIT\_B=Value specified by the INIT\_B attribute for output registers. Default is all zeros.  
 SRVAL\_B=register value.  
 addr=RAM address.  
 RAM(addr)=RAM contents at address ADDR.  
 data=RAM input data.  
 pdata=RAM parity data.  
 1WRITE\_MODE\_B=NO\_CHANGE.  
 2WRITE\_MODE\_B=READ\_FIRST.  
 3WRITE\_MODE\_B=WRITE\_FIRST.

## Port Descriptions

Port A						Port B				
Design Element	Data Cells(a)	Parity Cells(a)	Address Bus	Data Bus	Parity Bus	Data Cells(a)	Parity Cells(a)	Address Bus	Data Bus	Parity Bus
RAMB16_S1_S4	16384 x 1	-	(13:0)	(0:0)	-	4096 x 4	-	(11:0)	(3:0)	-
(a)Depth x Width										

Each port is fully synchronous with independent clock pins. All Port A input pins have setup time referenced to the CLKA pin and its data output bus DOA has a clock-to-out time referenced to the CLKA. All Port B input pins have setup time referenced to the CLKB pin and its data output bus DOB has a clock-to-out time referenced to the CLKB. The enable ENA pin controls read, write, and reset for Port A. When ENA is Low, no data is written and the outputs (DOA and DOPA) retain the last state. When ENA is High and reset (SSRA) is High, DOA and DOPA are set to SRVAL\_A during the Low-to-High clock (CLKA) transition; if write enable (WEA) is High, the memory contents reflect the data at DIA and DIPA. When ENA is High and WEA is Low, the data stored in the RAM address (ADDRA) is read during the Low-to-High clock transition. By default, WRITE\_MODE\_A=WRITE\_FIRST, when ENA and WEA are High, the data on the data inputs (DIA and DIPA) is loaded into the word selected by the write address (ADDRA) during the Low-to-High clock transition and the data outputs (DOA and DOPA) reflect the selected (addressed) word.

The enable ENB pin controls read, write, and reset for Port B. When ENB is Low, no data is written and the outputs (DOB and DOPB) retain the last state. When ENB is High and reset (SSRB) is High, DOB and DOPB are set to SRVAL\_B during the Low-to-High clock (CLKB) transition; if write enable (WEB) is High, the memory contents reflect the data at DIB and DIPB. When ENB is High and WEB is Low, the data stored in the RAM address (ADDRB) is read during the Low-to-High clock transition. By default, WRITE\_MODE\_B=WRITE\_FIRST, when ENB and WEB are High, the data on the data inputs (DIB and DIPB) are loaded into the word selected by the write address (ADDRB) during the Low-to-High clock transition and the data outputs (DOB and DOPB) reflect the selected (addressed) word. The above descriptions assume active High control pins (ENA, WEA, SSRA, CLKA, ENB, WEB, SSRB, and CLKB). However, the active level can be changed by placing an inverter on the port. Any inverter placed on a RAMB16 port is absorbed into the block and does not use a CLB resource.

### Address Mapping

Each port accesses the same set of 18432 memory cells using an addressing scheme that is dependent on the width of the port. For all port widths, 16384 memory cells are available for data as shown in the "Port Address Mapping for Data" table below. For 9-, 18-, and 36-bit wide ports, 2408 parity memory cells are also available as shown in "Port Address Mapping for Parity" table below. The physical RAM location that is addressed for a particular width is determined from the following formula.

$$\text{Start} = ((\text{ADDR port} + 1) * (\text{Widthport})) - 1$$

$$\text{End} = (\text{ADDRport}) * (\text{Widthport})$$

The following tables shows address mapping for each port width.

### Port Address Mapping for Data

Data Width	Port Data Addresses																																				
1	16384	<--	31	30	29	28	27	26	25	24	23	22	21	20	19	18	17	16	15	14	13	12	11	10	9	8	7	6	5	4	3	2	1	0			
2	8192	<--	15		14		13		12		11		10		9		8		7		6		5		4		3		2		1		0				
4	4096	<--	7				6				5				4				3				2					1				0					
8	2048	<--	3								2								1									0									
16	1024	<--	1																0																		
32	512	<--	0																																		

### Port Address Mapping for Parity

Parity Width	Port Parity Addresses																
1	2048	<-----	3					2					1				0
2	1024	<-----	1										0				
4	512	<-----	0														

#### Initializing Memory Contents of a Dual-Port RAMB16

You can use the INIT\_XX attributes to specify an initialization value for the memory contents of a RAMB16 during device configuration. The initialization of each RAMB16\_Sm\_Sn is set by 64 initialization attributes (INIT\_00 through INIT\_3F) of 64 hex values for a total of 16384 bits.

You can use the INITP\_XX attributes to specify an initial value for the parity memory during device configuration or assertion. The initialization of the parity memory for ports configured for 9, 18, or 36 bits is set by 8 initialization attributes (INITP\_00 through INITP\_07) of 64 hex values for a total of 2048 bits.

If any INIT\_XX or INITP\_XX attribute is not specified, it is configured as zeros. Partial Strings are padded with zeros to the left.

#### Initializing the Output Register of a Dual-Port RAMB16

In Spartan-3A, each bit in an output register can be initialized at power on (when GSR is high) to either a 0 or 1. In addition, the initial state specified for power on can be different than the state that results from assertion of a set/reset. Four properties control initialization of the output register for a dual-port RAMB16: INIT\_A, INIT\_B, SRVAL\_A, and SRVAL\_B. The INIT\_A attribute specifies the output register value at power on for Port A and the INIT\_B attribute specifies the value for Port B. You can use the SRVAL\_A attribute to define the state resulting from assertion of the SSR (set/reset) input on Port A. You can use the SRVAL\_B attribute to define the state resulting from assertion of the SSR input on Port B.

The INIT\_A, INIT\_B, SRVAL\_A, and SRVAL\_B attributes specify the initialization value as a hexadecimal String. The value is dependent upon the port width. For example, for a RAMB16\_S1\_S4 with Port A width equal to 1 and Port B width equal to 4, the Port A output register contains 1 bit and the Port B output register contains 4 bits. Therefore, the INIT\_A or SRVAL\_A value can only be specified as a 1 or 0. For Port B, the output register contains 4 bits. In this case, you can use INIT\_B or SRVAL\_B to specify a hexadecimal value from 0 through F to initialize the 4 bits of the output register.

For those ports that include parity bits, the parity portion of the output register is specified in the high order bit position of the INIT\_A, INIT\_B, SRVAL\_A, or SRVAL\_B value.

The INIT and SRVAL attributes default to zero if they are not set by you.

#### Write Mode Selection

The WRITE\_MODE\_A attribute controls the memory and output contents of Port A for a dual-port RAMB16. The WRITE\_MODE\_B attribute does the same for Port B. By default, both WRITE\_MODE\_A and WRITE\_MODE\_B are set to WRITE\_FIRST. This means that input is read, written to memory, and then passed to output. You can set the write mode for Port A and Port B to READ\_FIRST to read the memory contents, pass the memory contents to the outputs, and then write the input to memory. Or, you can set the write mode to NO\_CHANGE to have the input written to memory without changing the output. The "Port A and Port B Conflict Resolution" section describes how read/write conflicts are resolved when both Port A and Port B are attempting to read/write to the same memory cells.

#### Port A and Port B Conflict Resolution

Spartan-3A block SelectRAM is True Dual-Port RAM that allows both ports to simultaneously access the same memory cell. When one port writes to a given memory cell, the other port must not address that memory cell (for a write or a read) within the clock-to-clock setup window.

The following tables summarize the collision detection behavior of the dual-port RAMB16 based on the WRITE\_MODE\_A and WRITE\_MODE\_B settings.

*WRITE\_MODE\_A=NO\_CHANGE and WRITE\_MODE\_B=NO\_CHANGE*

WEA	WEB	CLKA	CLKB	DIA	DIB	DIPA	DIPB	DOA	DOB	DOPA	DOPB	Data RAM	Parity Ram
0	0	↑	↑	DIA	DIB	DIPA	DIPB	RAM	RAM	RAM	RAM	No Change	No Change
1	0	↑	↑	DIA	DIB	DIPA	DIPB	No Change	X	No Change	X	DIA	DIPA
0	1	↑	↑	DIA	DIB	DIPA	DIPB	X	No Change	X	No Change	DIB	DIPB
1	1	↑	↑	DIA	DIB	DIPA	DIPB	No Change	No Change	No Change	No Change	X	X

*WRITE\_MODE\_A=READ\_FIRST and WRITE\_MODE\_B=READ\_FIRST*

WEA	WEB	CLKA	CLKB	DIA	DIB	DIPA	DIPB	DOA	DOB	DOPA	DOPB	Data RAM	Parity Ram
0	0	↑	↑	DIA	DIB	DIPA	DIPB	RAM	RAM	RAM	RAM	No Change	No Change
1	0	↑	↑	DIA	DIB	DIPA	DIPB	RAM	RAM	RAM	RAM	DIA	DIPA
0	1	↑	↑	DIA	DIB	DIPA	DIPB	RAM	RAM	RAM	RAM	DIB	DIPB
1	1	↑	↑	DIA	DIB	DIPA	DIPB	RAM	RAM	RAM	RAM	X	X

*WRITE\_MODE\_A=WRITE\_FIRST and WRITE\_MODE\_B=WRITE\_FIRST*

WEA	WEB	CLKA	CLKB	DIA	DIB	DIPA	DIPB	DOA	DOB	DOPA	DOPB	Data RAM	Parity Ram
0	0	↑	↑	DIA	DIB	DIPA	DIPB	RAM	RAM	RAM	RAM	No Change	No Change
1	0	↑	↑	DIA	DIB	DIPA	DIPB	DIA	X	DIPA	X	DIA	DIPA
0	1	↑	↑	DIA	DIB	DIPA	DIPB	X	DIB	X	DIPB	DIB	DIPB
1	1	↑	↑	DIA	DIB	DIPA	DIPB	X	X	X	X	X	X

*WRITE\_MODE\_A=NO\_CHANGE and WRITE\_MODE\_B=READ\_FIRST*

WEA	WEB	CLKA	CLKB	DIA	DIB	DIPA	DIPB	DOA	DOB	DOPA	DOPB	Data RAM	Parity Ram
0	0	↑	↑	DIA	DIB	DIPA	DIPB	RAM	RAM	RAM	RAM	No Change	No Change
1	0	↑	↑	DIA	DIB	DIPA	DIPB	No Change	X	No Change	X	DIA	DIPA
0	1	↑	↑	DIA	DIB	DIPA	DIPB	RAM	RAM	RAM	RAM	DIB	DIPB
1	1	↑	↑	DIA	DIB	DIPA	DIPB	No Change	X	No Change	X	DIB	DIPB

*WRITE\_MODE\_A=NO\_CHANGE and WRITE\_MODE\_B=WRITE\_FIRST*

WEA	WEB	CLKA	CLKB	DIA	DIB	DIPA	DIPB	DOA	DOB	DOPA	DOPB	Data RAM	Parity Ram
0	0	↑	↑	DIA	DIB	DIPA	DIPB	RAM	RAM	RAM	RAM	No Change	No Change
1	0	↑	↑	DIA	DIB	DIPA	DIPB	No Change	X	No Change	X	DIA	DIPA

WEA	WEB	CLKA	CLKB	DIA	DIB	DIPA	DIPB	DOA	DOB	DOPA	DOPB	Data RAM	Parity Ram
0	1	↑	↑	DIA	DIB	DIPA	DIPB	X	DIB	X	DIPB	DIB	DIPB
1	1	↑	↑	DIA	DIB	DIPA	DIPB	No Change	X	No Change	X	X	X

WRITE\_MODE\_A=READ\_FIRST and WRITE\_MODE\_B=WRITE\_FIRST

WEA	WEB	CLKA	CLKB	DIA	DIB	DIPA	DIPB	DOA	DOB	DOPA	DOPB	Data RAM	Parity Ram
0	0	↑	↑	DIA	DIB	DIPA	DIPB	RAM	RAM	RAM	RAM	No Change	No Change
1	0	↑	↑	DIA	DIB	DIPA	DIPB	RAM	RAM	RAM	RAM	DIA	DIPA
0	1	↑	↑	DIA	DIB	DIPA	DIPB	X	DIB	X	DIPB	DIB	DIPB
1	1	↑	↑	DIA	DIB	DIPA	DIPB	X	DIB	X	DIPB	DIA	DIPA

## Design Entry Method

This design element can be used in schematics.

## Available Attributes

Attribute	Type	Allowed Values	Default	Description
INIT_00 To INIT_3F	Binary/Hexadecimal	Any	All zeros	Specifies the initial contents of the data portion of the RAM array.
INIT_A	Binary/Hexadecimal	Any	All zeros	Identifies the initial value of the DOA/DOB output port after completing configuration. For Type, the bit width is dependent on the width of the A or B port of the RAM.
INIT_B	Binary/Hexadecimal	Any	All zeros	Identifies the initial value of the DOA/DOB output port after completing configuration. For Type, the bit width is dependent on the width of the A or B port of the RAM.
INITP_00 To INITP_07	Binary/Hexadecimal	Any	All zeros	Specifies the initial contents of the parity portion of the RAM array.
SIM_COLLISION_CHECK	String	"ALL", "NONE", "WARNING", or "GENERATE_X_ONLY"	"ALL"	Specifies the behavior during simulation in the event of a data collision (data being read or written to the same address from both ports of the Ram simultaneously. "ALL" issues a warning to simulator console and generate an X or all unknown data due to the collision. This is the recommended setting. "WARNING" generates a warning only and "GENERATE_X_ONLY" generates an X for unknown data but won't output the occurrence to the simulation console. "NONE" completely ignores the error. It is suggested to only change this attribute if you can ensure the data generated during a collision is discarded.
SRVAL_A	Binary/Hexadecimal	Any	All zeros	Allows the individual selection of whether the DOA/DOB output port sets (go to a one) or reset (go to a zero) upon the assertion of the RSTA pin. For Type, the bit width is dependent on the width of the A port of the RAM.

Attribute	Type	Allowed Values	Default	Description
SRVAL_B	Binary/Hexadecimal	Any	All zeros	Allows the individual selection of whether the DOA/DOB output port sets (go to a one) or reset (go to a zero) upon the assertion of the RSTB pin. For Type, the bit width is dependent on the width of the B port of the RAM.
WRITE_MODE_A	String	"WRITE_FIRST", "READ_FIRST" or "NO_CHANGE"	"WRITE_FIRST"	Specifies the behavior of the DOA/DOB port upon a write command to the respected port. If set to WRITE_FIRST, the same port that is written to displays the contents of the written data to the outputs upon completion of the operation. "READ_FIRST" displays the prior contents of the RAM to the output port prior to writing the new data. "NO_CHANGE" keeps the previous value on the output port and won't update the output port upon a write command. This is the suggested mode if not using the read data from a particular port of the RAM
WRITE_MODE_B	String	"WRITE_FIRST", "READ_FIRST" or "NO_CHANGE"	"WRITE_FIRST"	Specifies the behavior of the DOA/DOB port upon a write command to the respected port. If set to WRITE_FIRST, the same port that is written to displays the contents of the written data to the outputs upon completion of the operation. "READ_FIRST" displays the prior contents of the RAM to the output port prior to writing the new data. "NO_CHANGE" keeps the previous value on the output port and won't update the output port upon a write command. This is the suggested mode if not using the read data from a particular port of the RAM.

## For More Information

- See the [Spartan-3 User Guide](#).
- See the [Spartan-3 Data Sheets](#).

# RAMB16\_S1\_S9

Primitive: 16K-bit Data and 2K-bit Parity Dual-Port Synchronous Block RAM with 1-bit and 9-bit Ports

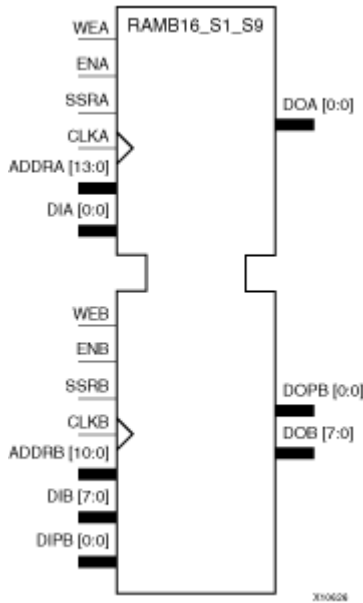

## Introduction

This design element is a dual-ported dedicated random access memory block with synchronous write capability. Each block RAM port has 16384 bits of data memory. Ports configured as 9, 18, or 36-bits wide have an additional 2048 bits of parity memory. Each port is independent of the other while accessing the same set of 16384 data memory cells. Each port is independently configured to a specific data width. The possible port and cell configurations for this element are listed under "Port Descriptions."

## Logic Table

Truth Table A

Inputs								Outputs			
GSR	ENA	SSRA	WEA	CLKA	ADDR_A	DIA	DIPA	DOA	DOPA	RAM Contents	
										Data RAM	Parity RAM
1	X	X	X	X	X	X	X	INIT_A	INIT_A	No Change	No Change
0	0	X	X	X	X	X	X	No Change	No Change	No Change	No Change
0	1	1	0	↑	X	X	X	SRVAL_A	SRVAL_A	No Change	No Change
0	1	1	1	↑	addr	data	pdata	SRVAL_A	SRVAL_A	RAM(addr) =>data	RAM(addr) =>pdata
0	1	0	0	↑	addr	X	X	RAM(addr)	RAM(addr)	No Change	No Change



Inputs								Outputs			
GSR	ENA	SSRA	WEA	CLKA	ADDRA	DIA	DIPA	DOA	DOPA	RAM Contents	
										Data RAM	Parity RAM
0	1	0	1	↑	addr	data	pdata	No Change1, RAM (addr)2, data3	No Change1, RAM (addr)2, pdata3	RAM(addr) =>data	RAM(addr) =>pdata

GSR=Global Set Reset  
 INIT\_A=Value specified by the INIT\_A attribute for output register. Default is all zeros.  
 SRVAL\_A=register value.  
 addr=RAM address.  
 RAM(addr)=RAM contents at address ADDR.  
 data=RAM input data.  
 pdata=RAM parity data.  
 1WRITE\_MODE\_A=NO\_CHANGE.  
 2WRITE\_MODE\_A=READ\_FIRST.  
 3WRITE\_MODE\_A=WRITE\_FIRST.

Truth Table B

Inputs								Outputs			
GSR	ENB	SSRB	WEB	CLKB	ADDRB	DIB	DIPB	DOB	DOPB	RAM Contents	
										Data RAM	Parity RAM
1	X	X	X	X	X	X	X	INIT_B	INIT_B	No Change	No Change
0	0	X	X	X	X	X	X	No Change	No Change	No Change	No Change
0	1	1	0	↑	X	X	X	SRVAL_B	SRVAL_B	No Change	No Change
0	1	1	1	↑	addr	data	pdata	SRVAL_B	SRVAL_B	RAM(addr) =>data	RAM(addr) =>pdata
0	1	0	0	↑	addr	X	X	RAM(addr)	RAM(addr)	No Change	No Change
0	1	0	1	↑	addr	data	pdata	No Change1, RAM (addr)2, data3	No Change1, RAM (addr)2, pdata3	RAM(addr)2	RAM(addr) =>pdata

GSR=Global Set Reset.  
 INIT\_B=Value specified by the INIT\_B attribute for output registers. Default is all zeros.  
 SRVAL\_B=register value.  
 addr=RAM address.  
 RAM(addr)=RAM contents at address ADDR.  
 data=RAM input data.  
 pdata=RAM parity data.  
 1WRITE\_MODE\_B=NO\_CHANGE.  
 2WRITE\_MODE\_B=READ\_FIRST.

See the ISE 10.1 User Guide for Schematic Designs

## Port Descriptions

Each port is fully synchronous with independent clock pins. All Port A input pins have setup time referenced to the CLKA pin and its data output bus DOA has a clock-to-out time referenced to the CLKA. All Port B input pins have setup time referenced to the CLKB pin and its data output bus DOB has a clock-to-out time referenced to the CLKB. The enable ENA pin controls read, write, and reset for Port A. When ENA is Low, no data is written and the outputs (DOA and DOPA) retain the last state. When ENA is High and reset (SSRA) is High, DOA and DOPA are set to SRVAL\_A during the Low-to-High clock (CLKA) transition; if write enable (WEA) is High, the memory contents reflect the data at DIA and DIPA. When ENA is High and WEA is Low, the data stored in the RAM address (ADDRA) is read during the Low-to-High clock transition. By default, WRITE\_MODE\_A=WRITE\_FIRST, when ENA and WEA are High, the data on the data inputs (DIA and DIPA) is loaded into the word selected by the write address (ADDRA) during the Low-to-High clock transition and the data outputs (DOA and DOPA) reflect the selected (addressed) word.

The enable ENB pin controls read, write, and reset for Port B. When ENB is Low, no data is written and the outputs (DOB and DOPB) retain the last state. When ENB is High and reset (SSRB) is High, DOB and DOPB are set to SRVAL\_B during the Low-to-High clock (CLKB) transition; if write enable (WEB) is High, the memory contents reflect the data at DIB and DIPB. When ENB is High and WEB is Low, the data stored in the RAM address (ADDRB) is read during the Low-to-High clock transition. By default, WRITE\_MODE\_B=WRITE\_FIRST, when ENB and WEB are High, the data on the data inputs (DIB and DIPB) are loaded into the word selected by the write address (ADDRB) during the Low-to-High clock transition and the data outputs (DOB and DOPB) reflect the selected (addressed) word. The above descriptions assume active High control pins (ENA, WEA, SSRA, CLKA, ENB, WEB, SSRB, and CLKB). However, the active level can be changed by placing an inverter on the port. Any inverter placed on a RAMB16 port is absorbed into the block and does not use a CLB resource.

### Address Mapping

Each port accesses the same set of 18432 memory cells using an addressing scheme that is dependent on the width of the port. For all port widths, 16384 memory cells are available for data as shown in the "Port Address Mapping for Data" table below. For 9-, 18-, and 36-bit wide ports, 2408 parity memory cells are also available as shown in "Port Address Mapping for Parity" table below. The physical RAM location that is addressed for a particular width is determined from the following formula.

$$\text{Start} = ((\text{ADDR}_{\text{port}} + 1) * (\text{Width}_{\text{port}})) - 1$$

$$\text{End} = (\text{ADDR}_{\text{port}}) * (\text{Width}_{\text{port}})$$

The following tables shows address mapping for each port width.

### Port Address Mapping for Data

Data Width	Port Data Addresses
1	16384 <-- 31 30 29 28 27 26 25 24 23 22 21 20 19 18 17 16 15 14 13 12 11 10 9 8 7 6 5 4 3 2 1 0
2	8192 <-- 15 14 13 12 11 10 9 8 7 6 5 4 3 2 1 0
4	4096 <-- 7 6 5 4 3 2 1 0
8	2048 <-- 3 2 1 0
16	1024 <-- 1 0
32	512 <-- 0

### Port Address Mapping for Parity

Parity Width	Port Parity Addresses
1	2048 <---- 3 2 1 0
2	1024 <---- 1 0
4	512 <---- 0

### Initializing Memory Contents of a Dual-Port RAMB16

You can use the INIT\_XX attributes to specify an initialization value for the memory contents of a RAMB16 during device configuration. The initialization of each RAMB16\_Sm\_Sn is set by 64 initialization attributes (INIT\_00 through INIT\_3F) of 64 hex values for a total of 16384 bits.

You can use the INITP\_XX attributes to specify an initial value for the parity memory during device configuration or assertion. The initialization of the parity memory for ports configured for 9, 18, or 36 bits is set by 8 initialization attributes (INITP\_00 through INITP\_07) of 64 hex values for a total of 2048 bits.

If any INIT\_XX or INITP\_XX attribute is not specified, it is configured as zeros. Partial Strings are padded with zeros to the left.

### Initializing the Output Register of a Dual-Port RAMB16

In Spartan-3A, each bit in an output register can be initialized at power on (when GSR is high) to either a 0 or 1. In addition, the initial state specified for power on can be different than the state that results from assertion of a set/reset. Four properties control initialization of the output register for a dual-port RAMB16: INIT\_A, INIT\_B, SRVAL\_A, and SRVAL\_B. The INIT\_A attribute specifies the output register value at power on for Port A and the INIT\_B attribute specifies the value for Port B. You can use the SRVAL\_A attribute to define the state resulting from assertion of the SSR (set/reset) input on Port A. You can use the SRVAL\_B attribute to define the state resulting from assertion of the SSR input on Port B.

The INIT\_A, INIT\_B, SRVAL\_A, and SRVAL\_B attributes specify the initialization value as a hexadecimal String. The value is dependent upon the port width. For example, for a RAMB16\_S1\_S4 with Port A width equal to 1 and Port B width equal to 4, the Port A output register contains 1 bit and the Port B output register contains 4 bits. Therefore, the INIT\_A or SRVAL\_A value can only be specified as a 1 or 0. For Port B, the output register contains 4 bits. In this case, you can use INIT\_B or SRVAL\_B to specify a hexadecimal value from 0 through F to initialize the 4 bits of the output register.

For those ports that include parity bits, the parity portion of the output register is specified in the high order bit position of the INIT\_A, INIT\_B, SRVAL\_A, or SRVAL\_B value.

The INIT and SRVAL attributes default to zero if they are not set by you.

### Write Mode Selection

The WRITE\_MODE\_A attribute controls the memory and output contents of Port A for a dual-port RAMB16. The WRITE\_MODE\_B attribute does the same for Port B. By default, both WRITE\_MODE\_A and WRITE\_MODE\_B are set to WRITE\_FIRST. This means that input is read, written to memory, and then passed to output. You can set the write mode for Port A and Port B to READ\_FIRST to read the memory contents, pass the memory contents to the outputs, and then write the input to memory. Or, you can set the write mode to NO\_CHANGE to have the input written to memory without changing the output. The "Port A and Port B Conflict Resolution" section describes how read/write conflicts are resolved when both Port A and Port B are attempting to read/write to the same memory cells.

### Port A and Port B Conflict Resolution

Spartan-3A block SelectRAM is True Dual-Port RAM that allows both ports to simultaneously access the same memory cell. When one port writes to a given memory cell, the other port must not address that memory cell (for a write or a read) within the clock-to-clock setup window.

The following tables summarize the collision detection behavior of the dual-port RAMB16 based on the WRITE\_MODE\_A and WRITE\_MODE\_B settings.

#### WRITE\_MODE\_A=NO\_CHANGE and WRITE\_MODE\_B=NO\_CHANGE

WEA	WEB	CLKA	CLKB	DIA	DIB	DIPA	DIPB	DOA	DOB	DOPA	DOPB	Data RAM	Parity Ram
0	0	↑	↑	DIA	DIB	DIPA	DIPB	RAM	RAM	RAM	RAM	No Change	No Change
1	0	↑	↑	DIA	DIB	DIPA	DIPB	No Change	X	No Change	X	DIA	DIPA

WEA	WEB	CLKA	CLKB	DIA	DIB	DIPA	DIPB	DOA	DOB	DOPA	DOPB	Data RAM	Parity Ram
0	1	↑	↑	DIA	DIB	DIPA	DIPB	X	No Change	X	No Change	DIB	DIPB
1	1	↑	↑	DIA	DIB	DIPA	DIPB	No Change	No Change	No Change	No Change	X	X

*WRITE\_MODE\_A=READ\_FIRST and WRITE\_MODE\_B=READ\_FIRST*

WEA	WEB	CLKA	CLKB	DIA	DIB	DIPA	DIPB	DOA	DOB	DOPA	DOPB	Data RAM	Parity Ram
0	0	↑	↑	DIA	DIB	DIPA	DIPB	RAM	RAM	RAM	RAM	No Change	No Change
1	0	↑	↑	DIA	DIB	DIPA	DIPB	RAM	RAM	RAM	RAM	DIA	DIPA
0	1	↑	↑	DIA	DIB	DIPA	DIPB	RAM	RAM	RAM	RAM	DIB	DIPB
1	1	↑	↑	DIA	DIB	DIPA	DIPB	RAM	RAM	RAM	RAM	X	X

*WRITE\_MODE\_A=WRITE\_FIRST and WRITE\_MODE\_B=WRITE\_FIRST*

WEA	WEB	CLKA	CLKB	DIA	DIB	DIPA	DIPB	DOA	DOB	DOPA	DOPB	Data RAM	Parity Ram
0	0	↑	↑	DIA	DIB	DIPA	DIPB	RAM	RAM	RAM	RAM	No Change	No Change
1	0	↑	↑	DIA	DIB	DIPA	DIPB	DIA	X	DIPA	X	DIA	DIPA
0	1	↑	↑	DIA	DIB	DIPA	DIPB	X	DIB	X	DIPB	DIB	DIPB
1	1	↑	↑	DIA	DIB	DIPA	DIPB	X	X	X	X	X	X

*WRITE\_MODE\_A=NO\_CHANGE and WRITE\_MODE\_B=READ\_FIRST*

WEA	WEB	CLKA	CLKB	DIA	DIB	DIPA	DIPB	DOA	DOB	DOPA	DOPB	Data RAM	Parity Ram
0	0	↑	↑	DIA	DIB	DIPA	DIPB	RAM	RAM	RAM	RAM	No Change	No Change
1	0	↑	↑	DIA	DIB	DIPA	DIPB	No Change	X	No Change	X	DIA	DIPA
0	1	↑	↑	DIA	DIB	DIPA	DIPB	RAM	RAM	RAM	RAM	DIB	DIPB
1	1	↑	↑	DIA	DIB	DIPA	DIPB	No Change	X	No Change	X	DIB	DIPB

*WRITE\_MODE\_A=NO\_CHANGE and WRITE\_MODE\_B=WRITE\_FIRST*

WEA	WEB	CLKA	CLKB	DIA	DIB	DIPA	DIPB	DOA	DOB	DOPA	DOPB	Data RAM	Parity Ram
0	0	↑	↑	DIA	DIB	DIPA	DIPB	RAM	RAM	RAM	RAM	No Change	No Change
1	0	↑	↑	DIA	DIB	DIPA	DIPB	No Change	X	No Change	X	DIA	DIPA
0	1	↑	↑	DIA	DIB	DIPA	DIPB	X	DIB	X	DIPB	DIB	DIPB
1	1	↑	↑	DIA	DIB	DIPA	DIPB	No Change	X	No Change	X	X	X

*WRITE\_MODE\_A=READ\_FIRST and WRITE\_MODE\_B=WRITE\_FIRST*

WEA	WEB	CLKA	CLKB	DIA	DIB	DIPA	DIPB	DOA	DOB	DOPA	DOPB	Data RAM	Parity Ram
0	0	↑	↑	DIA	DIB	DIPA	DIPB	RAM	RAM	RAM	RAM	No Change	No Change
1	0	↑	↑	DIA	DIB	DIPA	DIPB	RAM	RAM	RAM	RAM	DIA	DIPA
0	1	↑	↑	DIA	DIB	DIPA	DIPB	X	DIB	X	DIPB	DIB	DIPB
1	1	↑	↑	DIA	DIB	DIPA	DIPB	X	DIB	X	DIPB	DIA	DIPA

## Design Entry Method

This design element can be used in schematics.

## Available Attributes

Attribute	Type	Allowed Values	Default	Description
INIT_00 To INIT_3F	Binary/Hexadecimal	Any	All zeros	Specifies the initial contents of the data portion of the RAM array.
INIT_A	Binary/Hexadecimal	Any	All zeros	Identifies the initial value of the DOA/DOB output port after completing configuration. For Type, the bit width is dependent on the width of the A or B port of the RAM.
INIT_B	Binary/Hexadecimal	Any	All zeros	Identifies the initial value of the DOA/DOB output port after completing configuration. For Type, the bit width is dependent on the width of the A or B port of the RAM.
INITP_00 To INITP_07	Binary/Hexadecimal	Any	All zeros	Specifies the initial contents of the parity portion of the RAM array.
SIM_COLLISION_CHECK	String	"ALL", "NONE", "WARNING", or "GENERATE_X_ONLY"	"ALL"	Specifies the behavior during simulation in the event of a data collision (data being read or written to the same address from both ports of the Ram simultaneously. "ALL" issues a warning to simulator console and generate an X or all unknown data due to the collision. This is the recommended setting. "WARNING" generates a warning only and "GENERATE_X_ONLY" generates an X for unknown data but won't output the occurrence to the simulation console. "NONE" completely ignores the error. It is suggested to only change this attribute if you can ensure the data generated during a collision is discarded.
SRVAL_A	Binary/Hexadecimal	Any	All zeros	Allows the individual selection of whether the DOA/DOB output port sets (go to a one) or reset (go to a zero) upon the assertion of the RSTA pin. For Type, the bit width is dependent on the width of the A port of the RAM.
SRVAL_B	Binary/Hexadecimal	Any	All zeros	Allows the individual selection of whether the DOA/DOB output port sets (go to a one) or reset (go to a zero) upon the assertion of the RSTB pin. For Type, the bit width is dependent on the width of the B port of the RAM.

Attribute	Type	Allowed Values	Default	Description
WRITE_MODE_A	String	"WRITE_FIRST", "READ_FIRST" or "NO_CHANGE"	"WRITE_FIRST"	Specifies the behavior of the DOA/DOB port upon a write command to the respected port. If set to WRITE_FIRST, the same port that is written to displays the contents of the written data to the outputs upon completion of the operation. "READ_FIRST" displays the prior contents of the RAM to the output port prior to writing the new data. "NO_CHANGE" keeps the previous value on the output port and won't update the output port upon a write command. This is the suggested mode if not using the read data from a particular port of the RAM
WRITE_MODE_B	String	"WRITE_FIRST", "READ_FIRST" or "NO_CHANGE"	"WRITE_FIRST"	Specifies the behavior of the DOA/DOB port upon a write command to the respected port. If set to WRITE_FIRST, the same port that is written to displays the contents of the written data to the outputs upon completion of the operation. "READ_FIRST" displays the prior contents of the RAM to the output port prior to writing the new data. "NO_CHANGE" keeps the previous value on the output port and won't update the output port upon a write command. This is the suggested mode if not using the read data from a particular port of the RAM.

### For More Information

- See the [Spartan-3 User Guide](#).
- See the [Spartan-3 Data Sheets](#).

# RAMB16\_S18

Primitive: 16K-bit Data + 2K-bit Parity Memory, Single-Port Synchronous Block RAM with 18-bit Port

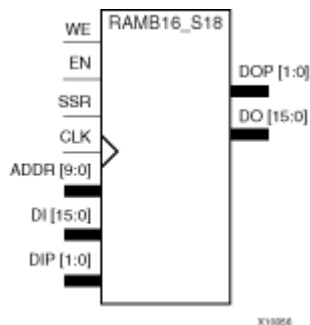

## Introduction

This design element is a dedicated random access memory blocks with synchronous write capability. The block RAM port has 16384 bits of data memory.

The enable ENA pin controls read, write, and reset for Port A. When ENA is Low, no data is written and the outputs (DOA and DOPA) retain the last state. When ENA is High and reset (SSRA) is High, DOA and DOPA are set to SRVAL\_A during the Low-to-High clock (CLKA) transition; if write enable (WEA) is High, the memory contents reflect the data at DIA and DIPA. When ENA is High and WEA is Low, the data stored in the RAM address (ADDRA) is read during the Low-to-High clock transition. By default, WRITE\_MODE\_A=WRITE\_FIRST, when ENA and WEA are High, the data on the data inputs (DIA and DIPA) is loaded into the word selected by the write address (ADDRA) during the Low-to-High clock transition and the data outputs (DOA and DOPA) reflect the selected (addressed) word.

The above description assumes an active High EN, WE, SSR, and CLK. However, the active level can be changed by placing an inverter on the port. Any inverter placed on a RAMB16 port is absorbed into the block and does not use a CLB resource.

The cell configuration for this element is listed in the following table.

	Data Cells		Parity Cells				
Component	Depth	Width	Depth	Width	Address Bus	Data Bus	Parity Bus
RAMB16_S18	1024	16	1024	2	(9:0)	(15:0)	(1:0)

## Design Entry Method

This design element can be used in schematics.

## Available Attributes

Attribute	Type	Allowed Values	Default	Description
INIT	Binary	Any Hex Value	All zeros	Identifies the initial value of the DO output port after completing configuration. The bit width is dependent on the width of the A or B port of the RAM.
INIT_00 - INIT_3F	Binary	Any Hex Value	All zeros	Specifies the initial contents of the data portion of the RAM array.

Attribute	Type	Allowed Values	Default	Description
INITP_00 - INITP_07	Binary	Any Hex Value	All zeros	Specifies the initial contents of the parity portion of the RAM array.
SRVAL	Binary	Any Hex Value	All zeros	Allows the individual selection of whether the DO output port sets (go to a one) or reset (go to a zero) upon the assertion of the SSR pin. The bit width is dependent on the width of the A or B port of the RAM.
WRITE_MODE	String	"WRITE_FIRST", "READ_FIRST" or "NO_CHANGE"	"WRITE_FIRST"	Specifies the behavior of the DO port upon a write command to the respected port. If set to "WRITE_FIRST", the same port that is written to displays the contents of the written data to the outputs upon completion of the operation. "READ_FIRST" displays the prior contents of the RAM to the output port prior to writing the new data. "NO_CHANGE" keeps the previous value on the output port and won't update the output port upon a write command. This is the suggested mode if not using the read data from a particular port of the RAM.

### For More Information

- See the [Spartan-3 User Guide](#).
- See the [Spartan-3 Data Sheets](#).



# RAMB16\_S18\_S18

Primitive: 16K-bit Data and 2K-bit Parity Dual-Port Synchronous Block RAM with 18-bit Ports

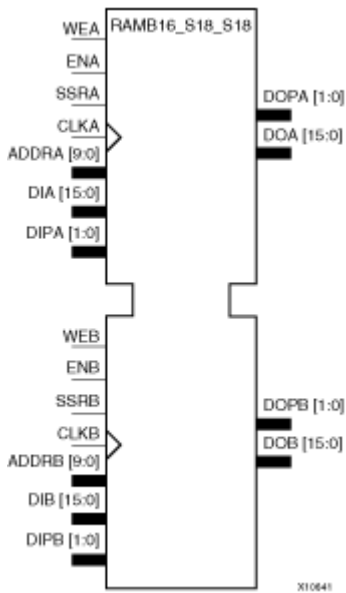

## Introduction

This design element is a dual-ported dedicated random access memory block with synchronous write capability. Each block RAM port has 16384 bits of data memory. Ports configured as 9, 18, or 36-bits wide have an additional 2048 bits of parity memory. Each port is independent of the other while accessing the same set of 16384 data memory cells. Each port is independently configured to a specific data width. The possible port and cell configurations for this element are listed under "Port Descriptions."

## Logic Table

Truth Table A

Inputs								Outputs			
GSR	ENA	SSRA	WEA	CLKA	ADDR_A	DIA	DIPA	DOA	DOPA	RAM Contents	
										Data RAM	Parity RAM
1	X	X	X	X	X	X	X	INIT_A	INIT_A	No Change	No Change
0	0	X	X	X	X	X	X	No Change	No Change	No Change	No Change
0	1	1	0	↑	X	X	X	SRVAL_A	SRVAL_A	No Change	No Change
0	1	1	1	↑	addr	data	pdata	SRVAL_A	SRVAL_A	RAM(addr) =>data	RAM(addr) =>pdata
0	1	0	0	↑	addr	X	X	RAM(addr)	RAM(addr)	No Change	No Change

Inputs								Outputs			
GSR	ENA	SSRA	WEA	CLKA	ADDRA	DIA	DIPA	DOA	DOPA	RAM Contents	
										Data RAM	Parity RAM
0	1	0	1	↑	addr	data	pdata	No Change1, RAM (addr)2, data3	No Change1, RAM (addr)2, pdata3	RAM(addr) =>data	RAM(addr) =>pdata

GSR=Global Set Reset  
 INIT\_A=Value specified by the INIT\_A attribute for output register. Default is all zeros.  
 SRVAL\_A=register value.  
 addr=RAM address.  
 RAM(addr)=RAM contents at address ADDR.  
 data=RAM input data.  
 pdata=RAM parity data.  
 1WRITE\_MODE\_A=NO\_CHANGE.  
 2WRITE\_MODE\_A=READ\_FIRST.  
 3WRITE\_MODE\_A=WRITE\_FIRST.

Truth Table B

Inputs								Outputs			
GSR	ENB	SSRB	WEB	CLKB	ADDRB	DIB	DIPB	DOB	DOPB	RAM Contents	
										Data RAM	Parity RAM
1	X	X	X	X	X	X	X	INIT_B	INIT_B	No Change	No Change
0	0	X	X	X	X	X	X	No Change	No Change	No Change	No Change
0	1	1	0	↑	X	X	X	SRVAL_B	SRVAL_B	No Change	No Change
0	1	1	1	↑	addr	data	pdata	SRVAL_B	SRVAL_B	RAM(addr) =>data	RAM(addr) =>pdata
0	1	0	0	↑	addr	X	X	RAM(addr)	RAM(addr)	No Change	No Change
0	1	0	1	↑	addr	data	pdata	No Change1, RAM (addr)2, data3	No Change1, RAM (addr)2, pdata3	RAM(addr)2	RAM(addr) =>pdata

GSR=Global Set Reset.  
 INIT\_B=Value specified by the INIT\_B attribute for output registers. Default is all zeros.  
 SRVAL\_B=register value.  
 addr=RAM address.  
 RAM(addr)=RAM contents at address ADDR.  
 data=RAM input data.  
 pdata=RAM parity data.  
 1WRITE\_MODE\_B=NO\_CHANGE.  
 2WRITE\_MODE\_B=READ\_FIRST.  
 3WRITE\_MODE\_B=WRITE\_FIRST.

## Port Descriptions

Port A						Port B				
Design Element	Data Cells(a)	Parity Cells(a)	Address Bus	Data Bus	Parity Bus	Data Cells(a)	Parity Cells(a)	Address Bus	Data Bus	Parity Bus
RAMB16_S18_S18	1024 x 16	1024 x 2	(9:0)	(15:0)	(1:0)	1024 x 16	1024 x 2	(9:0)	(15:0)	(1:0)
(a)Depth x Width										

Each port is fully synchronous with independent clock pins. All Port A input pins have setup time referenced to the CLKA pin and its data output bus DOA has a clock-to-out time referenced to the CLKA. All Port B input pins have setup time referenced to the CLKB pin and its data output bus DOB has a clock-to-out time referenced to the CLKB. The enable ENA pin controls read, write, and reset for Port A. When ENA is Low, no data is written and the outputs (DOA and DOPA) retain the last state. When ENA is High and reset (SSRA) is High, DOA and DOPA are set to SRVAL\_A during the Low-to-High clock (CLKA) transition; if write enable (WEA) is High, the memory contents reflect the data at DIA and DIPA. When ENA is High and WEA is Low, the data stored in the RAM address (ADDRA) is read during the Low-to-High clock transition. By default, WRITE\_MODE\_A=WRITE\_FIRST, when ENA and WEA are High, the data on the data inputs (DIA and DIPA) is loaded into the word selected by the write address (ADDRA) during the Low-to-High clock transition and the data outputs (DOA and DOPA) reflect the selected (addressed) word.

The enable ENB pin controls read, write, and reset for Port B. When ENB is Low, no data is written and the outputs (DOB and DOPB) retain the last state. When ENB is High and reset (SSRB) is High, DOB and DOPB are set to SRVAL\_B during the Low-to-High clock (CLKB) transition; if write enable (WEB) is High, the memory contents reflect the data at DIB and DIPB. When ENB is High and WEB is Low, the data stored in the RAM address (ADDRB) is read during the Low-to-High clock transition. By default, WRITE\_MODE\_B=WRITE\_FIRST, when ENB and WEB are High, the data on the data inputs (DIB and DIPB) are loaded into the word selected by the write address (ADDRB) during the Low-to-High clock transition and the data outputs (DOB and DOPB) reflect the selected (addressed) word. The above descriptions assume active High control pins (ENA, WEA, SSRA, CLKA, ENB, WEB, SSRB, and CLKB). However, the active level can be changed by placing an inverter on the port. Any inverter placed on a RAMB16 port is absorbed into the block and does not use a CLB resource.

### Address Mapping

Each port accesses the same set of 18432 memory cells using an addressing scheme that is dependent on the width of the port. For all port widths, 16384 memory cells are available for data as shown in the "Port Address Mapping for Data" table below. For 9-, 18-, and 36-bit wide ports, 2408 parity memory cells are also available as shown in "Port Address Mapping for Parity" table below. The physical RAM location that is addressed for a particular width is determined from the following formula.

$$\text{Start} = ((\text{ADDR port} + 1) * (\text{Widthport})) - 1$$

$$\text{End} = (\text{ADDRport}) * (\text{Widthport})$$

The following tables show address mapping for each port width.

### Port Address Mapping for Data

Data Width	Port Data Addresses																																				
1	16384	<--	31	30	29	28	27	26	25	24	23	22	21	20	19	18	17	16	15	14	13	12	11	10	9	8	7	6	5	4	3	2	1	0			
2	8192	<--	15		14		13		12		11		10		9		8		7		6		5		4		3		2		1		0				
4	4096	<--	7				6				5				4				3				2					1				0					
8	2048	<--	3								2								1									0									
16	1024	<--	1																0																		
32	512	<--	0																																		

### Port Address Mapping for Parity

Parity Width	Port Parity Addresses																	
1	2048	<-----	3					2					1					0
2	1024	<-----	1										0					
4	512	<-----	0															

#### Initializing Memory Contents of a Dual-Port RAMB16

You can use the INIT\_XX attributes to specify an initialization value for the memory contents of a RAMB16 during device configuration. The initialization of each RAMB16\_Sm\_Sn is set by 64 initialization attributes (INIT\_00 through INIT\_3F) of 64 hex values for a total of 16384 bits.

You can use the INITP\_XX attributes to specify an initial value for the parity memory during device configuration or assertion. The initialization of the parity memory for ports configured for 9, 18, or 36 bits is set by 8 initialization attributes (INITP\_00 through INITP\_07) of 64 hex values for a total of 2048 bits.

If any INIT\_XX or INITP\_XX attribute is not specified, it is configured as zeros. Partial Strings are padded with zeros to the left.

#### Initializing the Output Register of a Dual-Port RAMB16

In Spartan-3A, each bit in an output register can be initialized at power on (when GSR is high) to either a 0 or 1. In addition, the initial state specified for power on can be different than the state that results from assertion of a set/reset. Four properties control initialization of the output register for a dual-port RAMB16: INIT\_A, INIT\_B, SRVAL\_A, and SRVAL\_B. The INIT\_A attribute specifies the output register value at power on for Port A and the INIT\_B attribute specifies the value for Port B. You can use the SRVAL\_A attribute to define the state resulting from assertion of the SSR (set/reset) input on Port A. You can use the SRVAL\_B attribute to define the state resulting from assertion of the SSR input on Port B.

The INIT\_A, INIT\_B, SRVAL\_A, and SRVAL\_B attributes specify the initialization value as a hexadecimal String. The value is dependent upon the port width. For example, for a RAMB16\_S1\_S4 with Port A width equal to 1 and Port B width equal to 4, the Port A output register contains 1 bit and the Port B output register contains 4 bits. Therefore, the INIT\_A or SRVAL\_A value can only be specified as a 1 or 0. For Port B, the output register contains 4 bits. In this case, you can use INIT\_B or SRVAL\_B to specify a hexadecimal value from 0 through F to initialize the 4 bits of the output register.

For those ports that include parity bits, the parity portion of the output register is specified in the high order bit position of the INIT\_A, INIT\_B, SRVAL\_A, or SRVAL\_B value.

The INIT and SRVAL attributes default to zero if they are not set by you.

#### Write Mode Selection

The WRITE\_MODE\_A attribute controls the memory and output contents of Port A for a dual-port RAMB16. The WRITE\_MODE\_B attribute does the same for Port B. By default, both WRITE\_MODE\_A and WRITE\_MODE\_B are set to WRITE\_FIRST. This means that input is read, written to memory, and then passed to output. You can set the write mode for Port A and Port B to READ\_FIRST to read the memory contents, pass the memory contents to the outputs, and then write the input to memory. Or, you can set the write mode to NO\_CHANGE to have the input written to memory without changing the output. The "Port A and Port B Conflict Resolution" section describes how read/write conflicts are resolved when both Port A and Port B are attempting to read/write to the same memory cells.

#### Port A and Port B Conflict Resolution

Spartan-3A block SelectRAM is True Dual-Port RAM that allows both ports to simultaneously access the same memory cell. When one port writes to a given memory cell, the other port must not address that memory cell (for a write or a read) within the clock-to-clock setup window.

The following tables summarize the collision detection behavior of the dual-port RAMB16 based on the WRITE\_MODE\_A and WRITE\_MODE\_B settings.

*WRITE\_MODE\_A=NO\_CHANGE and WRITE\_MODE\_B=NO\_CHANGE*

WEA	WEB	CLKA	CLKB	DIA	DIB	DIPA	DIPB	DOA	DOB	DOPA	DOPB	Data RAM	Parity Ram
0	0	↑	↑	DIA	DIB	DIPA	DIPB	RAM	RAM	RAM	RAM	No Change	No Change
1	0	↑	↑	DIA	DIB	DIPA	DIPB	No Change	X	No Change	X	DIA	DIPA
0	1	↑	↑	DIA	DIB	DIPA	DIPB	X	No Change	X	No Change	DIB	DIPB
1	1	↑	↑	DIA	DIB	DIPA	DIPB	No Change	No Change	No Change	No Change	X	X

*WRITE\_MODE\_A=READ\_FIRST and WRITE\_MODE\_B=READ\_FIRST*

WEA	WEB	CLKA	CLKB	DIA	DIB	DIPA	DIPB	DOA	DOB	DOPA	DOPB	Data RAM	Parity Ram
0	0	↑	↑	DIA	DIB	DIPA	DIPB	RAM	RAM	RAM	RAM	No Change	No Change
1	0	↑	↑	DIA	DIB	DIPA	DIPB	RAM	RAM	RAM	RAM	DIA	DIPA
0	1	↑	↑	DIA	DIB	DIPA	DIPB	RAM	RAM	RAM	RAM	DIB	DIPB
1	1	↑	↑	DIA	DIB	DIPA	DIPB	RAM	RAM	RAM	RAM	X	X

*WRITE\_MODE\_A=WRITE\_FIRST and WRITE\_MODE\_B=WRITE\_FIRST*

WEA	WEB	CLKA	CLKB	DIA	DIB	DIPA	DIPB	DOA	DOB	DOPA	DOPB	Data RAM	Parity Ram
0	0	↑	↑	DIA	DIB	DIPA	DIPB	RAM	RAM	RAM	RAM	No Change	No Change
1	0	↑	↑	DIA	DIB	DIPA	DIPB	DIA	X	DIPA	X	DIA	DIPA
0	1	↑	↑	DIA	DIB	DIPA	DIPB	X	DIB	X	DIPB	DIB	DIPB
1	1	↑	↑	DIA	DIB	DIPA	DIPB	X	X	X	X	X	X

*WRITE\_MODE\_A=NO\_CHANGE and WRITE\_MODE\_B=READ\_FIRST*

WEA	WEB	CLKA	CLKB	DIA	DIB	DIPA	DIPB	DOA	DOB	DOPA	DOPB	Data RAM	Parity Ram
0	0	↑	↑	DIA	DIB	DIPA	DIPB	RAM	RAM	RAM	RAM	No Change	No Change
1	0	↑	↑	DIA	DIB	DIPA	DIPB	No Change	X	No Change	X	DIA	DIPA
0	1	↑	↑	DIA	DIB	DIPA	DIPB	RAM	RAM	RAM	RAM	DIB	DIPB
1	1	↑	↑	DIA	DIB	DIPA	DIPB	No Change	X	No Change	X	DIB	DIPB

*WRITE\_MODE\_A=NO\_CHANGE and WRITE\_MODE\_B=WRITE\_FIRST*

WEA	WEB	CLKA	CLKB	DIA	DIB	DIPA	DIPB	DOA	DOB	DOPA	DOPB	Data RAM	Parity Ram
0	0	↑	↑	DIA	DIB	DIPA	DIPB	RAM	RAM	RAM	RAM	No Change	No Change
1	0	↑	↑	DIA	DIB	DIPA	DIPB	No Change	X	No Change	X	DIA	DIPA
0	1	↑	↑	DIA	DIB	DIPA	DIPB	X	DIB	X	DIPB	DIB	DIPB
1	1	↑	↑	DIA	DIB	DIPA	DIPB	No Change	X	No Change	X	X	X

WRITE\_MODE\_A=READ\_FIRST and WRITE\_MODE\_B=WRITE\_FIRST

WEA	WEB	CLKA	CLKB	DIA	DIB	DIPA	DIPB	DOA	DOB	DOPA	DOPB	Data RAM	Parity Ram
0	0	↑	↑	DIA	DIB	DIPA	DIPB	RAM	RAM	RAM	RAM	No Change	No Change
1	0	↑	↑	DIA	DIB	DIPA	DIPB	RAM	RAM	RAM	RAM	DIA	DIPA
0	1	↑	↑	DIA	DIB	DIPA	DIPB	X	DIB	X	DIPB	DIB	DIPB
1	1	↑	↑	DIA	DIB	DIPA	DIPB	X	DIB	X	DIPB	DIA	DIPA

## Design Entry Method

This design element can be used in schematics.

## Available Attributes

Attribute	Type	Allowed Values	Default	Description
INIT_00 To INIT_3F	Binary/Hexadecimal	Any	All zeros	Specifies the initial contents of the data portion of the RAM array.
INIT_A	Binary/Hexadecimal	Any	All zeros	Identifies the initial value of the DOA/DOB output port after completing configuration. For Type, the bit width is dependent on the width of the A or B port of the RAM.
INIT_B	Binary/Hexadecimal	Any	All zeros	Identifies the initial value of the DOA/DOB output port after completing configuration. For Type, the bit width is dependent on the width of the A or B port of the RAM.
INITP_00 To INITP_07	Binary/Hexadecimal	Any	All zeros	Specifies the initial contents of the parity portion of the RAM array.
SIM_COLLISION_CHECK	String	"ALL", "NONE", "WARNING", or "GENERATE_X_ONLY"	"ALL"	Specifies the behavior during simulation in the event of a data collision (data being read or written to the same address from both ports of the Ram simultaneously. "ALL" issues a warning to simulator console and generate an X or all unknown data due to the collision. This is the recommended setting. "WARNING" generates a warning only and "GENERATE_X_ONLY" generates an X for unknown data but won't output the occurrence to the simulation console. "NONE" completely ignores the error. It is suggested to only change this attribute if you can ensure the data generated during a collision is discarded.
SRVAL_A	Binary/Hexadecimal	Any	All zeros	Allows the individual selection of whether the DOA/DOB output port sets (go to a one) or reset (go to a zero) upon the assertion of the RSTA pin. For Type, the bit width is dependent on the width of the A port of the RAM.
SRVAL_B	Binary/Hexadecimal	Any	All zeros	Allows the individual selection of whether the DOA/DOB output port sets (go to a one) or reset (go to a zero) upon the assertion of the RSTB pin. For Type, the bit width is dependent on the width of the B port of the RAM.

Attribute	Type	Allowed Values	Default	Description
WRITE_MODE_A	String	"WRITE_FIRST", "READ_FIRST" or "NO_CHANGE"	"WRITE_FIRST"	Specifies the behavior of the DOA/DOB port upon a write command to the respected port. If set to WRITE_FIRST, the same port that is written to displays the contents of the written data to the outputs upon completion of the operation. "READ_FIRST" displays the prior contents of the RAM to the output port prior to writing the new data. "NO_CHANGE" keeps the previous value on the output port and won't update the output port upon a write command. This is the suggested mode if not using the read data from a particular port of the RAM
WRITE_MODE_B	String	"WRITE_FIRST", "READ_FIRST" or "NO_CHANGE"	"WRITE_FIRST"	Specifies the behavior of the DOA/DOB port upon a write command to the respected port. If set to WRITE_FIRST, the same port that is written to displays the contents of the written data to the outputs upon completion of the operation. "READ_FIRST" displays the prior contents of the RAM to the output port prior to writing the new data. "NO_CHANGE" keeps the previous value on the output port and won't update the output port upon a write command. This is the suggested mode if not using the read data from a particular port of the RAM.

### For More Information

- See the [Spartan-3 User Guide](#).
- See the [Spartan-3 Data Sheets](#).

# RAMB16\_S18\_S36

Primitive: 16K-bit Data and 2K-bit Parity Dual-Port Synchronous Block RAM with 18-bit and 36-bit Ports

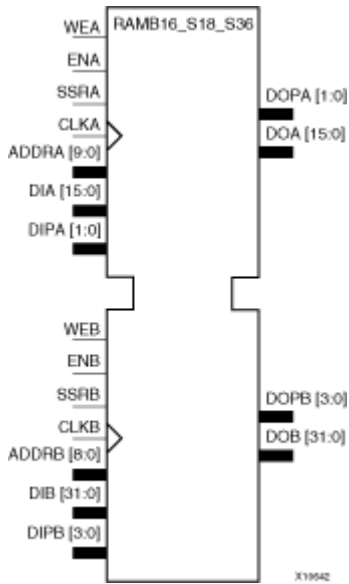

## Introduction

This design element is a dual-ported dedicated random access memory block with synchronous write capability. Each block RAM port has 16384 bits of data memory. Ports configured as 9, 18, or 36-bits wide have an additional 2048 bits of parity memory. Each port is independent of the other while accessing the same set of 16384 data memory cells. Each port is independently configured to a specific data width. The possible port and cell configurations for this element are listed under "Port Descriptions."

## Logic Table

Truth Table A

Inputs								Outputs			
GSR	ENA	SSRA	WEA	CLKA	ADDR_A	DIA	DIPA	DOA	DOPA	RAM Contents	
										Data RAM	Parity RAM
1	X	X	X	X	X	X	X	INIT_A	INIT_A	No Change	No Change
0	0	X	X	X	X	X	X	No Change	No Change	No Change	No Change
0	1	1	0	↑	X	X	X	SRVAL_A	SRVAL_A	No Change	No Change
0	1	1	1	↑	addr	data	pdata	SRVAL_A	SRVAL_A	RAM(addr) =>data	RAM(addr) =>pdata
0	1	0	0	↑	addr	X	X	RAM(addr)	RAM(addr)	No Change	No Change



Inputs								Outputs			
GSR	ENA	SSRA	WEA	CLKA	ADDRA	DIA	DIPA	DOA	DOPA	RAM Contents	
										Data RAM	Parity RAM
0	1	0	1	↑	addr	data	pdata	No Change1, RAM (addr)2, data3	No Change1, RAM (addr)2, pdata3	RAM(addr) =>data	RAM(addr) =>pdata

GSR=Global Set Reset  
 INIT\_A=Value specified by the INIT\_A attribute for output register. Default is all zeros.  
 SRVAL\_A=register value.  
 addr=RAM address.  
 RAM(addr)=RAM contents at address ADDR.  
 data=RAM input data.  
 pdata=RAM parity data.  
 1WRITE\_MODE\_A=NO\_CHANGE.  
 2WRITE\_MODE\_A=READ\_FIRST.  
 3WRITE\_MODE\_A=WRITE\_FIRST.

Truth Table B

Inputs								Outputs			
GSR	ENB	SSRB	WEB	CLKB	ADDRB	DIB	DIPB	DOB	DOPB	RAM Contents	
										Data RAM	Parity RAM
1	X	X	X	X	X	X	X	INIT_B	INIT_B	No Change	No Change
0	0	X	X	X	X	X	X	No Change	No Change	No Change	No Change
0	1	1	0	↑	X	X	X	SRVAL_B	SRVAL_B	No Change	No Change
0	1	1	1	↑	addr	data	pdata	SRVAL_B	SRVAL_B	RAM(addr) =>data	RAM(addr) =>pdata
0	1	0	0	↑	addr	X	X	RAM(addr)	RAM(addr)	No Change	No Change
0	1	0	1	↑	addr	data	pdata	No Change1, RAM (addr)2, data3	No Change1, RAM (addr)2, pdata3	RAM(addr)2	RAM(addr) =>pdata

GSR=Global Set Reset.  
 INIT\_B=Value specified by the INIT\_B attribute for output registers. Default is all zeros.  
 SRVAL\_B=register value.  
 addr=RAM address.  
 RAM(addr)=RAM contents at address ADDR.  
 data=RAM input data.  
 pdata=RAM parity data.  
 1WRITE\_MODE\_B=NO\_CHANGE.  
 2WRITE\_MODE\_B=READ\_FIRST.

See the ISE 10.1 User Guide for Schematic Designs

## Port Descriptions

Port A						Port B				
Design Element	Data Cells(a)	Parity Cells(a)	Address Bus	Data Bus	Parity Bus	Data Cells(a)	Parity Cells(a)	Address Bus	Data Bus	Parity Bus
RAMB16_S18_S36	1024 x 16	1024 x 2	(9:0)	(15:0)	(1:0)	512 x 32	512 x 4	(8:0)	(31:0)	(3:0)
(a)Depth x Width										

Each port is fully synchronous with independent clock pins. All Port A input pins have setup time referenced to the CLKA pin and its data output bus DOA has a clock-to-out time referenced to the CLKA. All Port B input pins have setup time referenced to the CLKB pin and its data output bus DOB has a clock-to-out time referenced to the CLKB. The enable ENA pin controls read, write, and reset for Port A. When ENA is Low, no data is written and the outputs (DOA and DOPA) retain the last state. When ENA is High and reset (SSRA) is High, DOA and DOPA are set to SRVAL\_A during the Low-to-High clock (CLKA) transition; if write enable (WEA) is High, the memory contents reflect the data at DIA and DIPA. When ENA is High and WEA is Low, the data stored in the RAM address (ADDRA) is read during the Low-to-High clock transition. By default, WRITE\_MODE\_A=WRITE\_FIRST, when ENA and WEA are High, the data on the data inputs (DIA and DIPA) is loaded into the word selected by the write address (ADDRA) during the Low-to-High clock transition and the data outputs (DOA and DOPA) reflect the selected (addressed) word.

The enable ENB pin controls read, write, and reset for Port B. When ENB is Low, no data is written and the outputs (DOB and DOPB) retain the last state. When ENB is High and reset (SSRB) is High, DOB and DOPB are set to SRVAL\_B during the Low-to-High clock (CLKB) transition; if write enable (WEB) is High, the memory contents reflect the data at DIB and DIPB. When ENB is High and WEB is Low, the data stored in the RAM address (ADDRB) is read during the Low-to-High clock transition. By default, WRITE\_MODE\_B=WRITE\_FIRST, when ENB and WEB are High, the data on the data inputs (DIB and DIPB) are loaded into the word selected by the write address (ADDRB) during the Low-to-High clock transition and the data outputs (DOB and DOPB) reflect the selected (addressed) word. The above descriptions assume active High control pins (ENA, WEA, SSRA, CLKA, ENB, WEB, SSRB, and CLKB). However, the active level can be changed by placing an inverter on the port. Any inverter placed on a RAMB16 port is absorbed into the block and does not use a CLB resource.

### Address Mapping

Each port accesses the same set of 18432 memory cells using an addressing scheme that is dependent on the width of the port. For all port widths, 16384 memory cells are available for data as shown in the "Port Address Mapping for Data" table below. For 9-, 18-, and 36-bit wide ports, 2408 parity memory cells are also available as shown in "Port Address Mapping for Parity" table below. The physical RAM location that is addressed for a particular width is determined from the following formula.

$$\text{Start} = ((\text{ADDR}_{\text{port}} + 1) * (\text{Width}_{\text{port}})) - 1$$

$$\text{End} = (\text{ADDR}_{\text{port}}) * (\text{Width}_{\text{port}})$$

The following tables shows address mapping for each port width.

### Port Address Mapping for Data

Data Width	Port Data Addresses																																		
1	16384	<--	31	30	29	28	27	26	25	24	23	22	21	20	19	18	17	16	15	14	13	12	11	10	9	8	7	6	5	4	3	2	1	0	
2	8192	<--	15		14		13		12		11		10		9		8		7		6		5		4		3		2		1		0		
4	4096	<--	7				6				5				4				3				2				1				0				
8	2048	<--	3								2								1								0								
16	1024	<--	1																0																
32	512	<--	0																																

### Port Address Mapping for Parity

Parity Width	Port Parity Addresses																
1	2048	<-----	3					2					1				0
2	1024	<-----	1										0				
4	512	<-----	0														

#### Initializing Memory Contents of a Dual-Port RAMB16

You can use the INIT\_XX attributes to specify an initialization value for the memory contents of a RAMB16 during device configuration. The initialization of each RAMB16\_Sm\_Sn is set by 64 initialization attributes (INIT\_00 through INIT\_3F) of 64 hex values for a total of 16384 bits.

You can use the INITP\_XX attributes to specify an initial value for the parity memory during device configuration or assertion. The initialization of the parity memory for ports configured for 9, 18, or 36 bits is set by 8 initialization attributes (INITP\_00 through INITP\_07) of 64 hex values for a total of 2048 bits.

If any INIT\_XX or INITP\_XX attribute is not specified, it is configured as zeros. Partial Strings are padded with zeros to the left.

#### Initializing the Output Register of a Dual-Port RAMB16

In Spartan-3A, each bit in an output register can be initialized at power on (when GSR is high) to either a 0 or 1. In addition, the initial state specified for power on can be different than the state that results from assertion of a set/reset. Four properties control initialization of the output register for a dual-port RAMB16: INIT\_A, INIT\_B, SRVAL\_A, and SRVAL\_B. The INIT\_A attribute specifies the output register value at power on for Port A and the INIT\_B attribute specifies the value for Port B. You can use the SRVAL\_A attribute to define the state resulting from assertion of the SSR (set/reset) input on Port A. You can use the SRVAL\_B attribute to define the state resulting from assertion of the SSR input on Port B.

The INIT\_A, INIT\_B, SRVAL\_A, and SRVAL\_B attributes specify the initialization value as a hexadecimal String. The value is dependent upon the port width. For example, for a RAMB16\_S1\_S4 with Port A width equal to 1 and Port B width equal to 4, the Port A output register contains 1 bit and the Port B output register contains 4 bits. Therefore, the INIT\_A or SRVAL\_A value can only be specified as a 1 or 0. For Port B, the output register contains 4 bits. In this case, you can use INIT\_B or SRVAL\_B to specify a hexadecimal value from 0 through F to initialize the 4 bits of the output register.

For those ports that include parity bits, the parity portion of the output register is specified in the high order bit position of the INIT\_A, INIT\_B, SRVAL\_A, or SRVAL\_B value.

The INIT and SRVAL attributes default to zero if they are not set by you.

#### Write Mode Selection

The WRITE\_MODE\_A attribute controls the memory and output contents of Port A for a dual-port RAMB16. The WRITE\_MODE\_B attribute does the same for Port B. By default, both WRITE\_MODE\_A and WRITE\_MODE\_B are set to WRITE\_FIRST. This means that input is read, written to memory, and then passed to output. You can set the write mode for Port A and Port B to READ\_FIRST to read the memory contents, pass the memory contents to the outputs, and then write the input to memory. Or, you can set the write mode to NO\_CHANGE to have the input written to memory without changing the output. The "Port A and Port B Conflict Resolution" section describes how read/write conflicts are resolved when both Port A and Port B are attempting to read/write to the same memory cells.

#### Port A and Port B Conflict Resolution

Spartan-3A block SelectRAM is True Dual-Port RAM that allows both ports to simultaneously access the same memory cell. When one port writes to a given memory cell, the other port must not address that memory cell (for a write or a read) within the clock-to-clock setup window.

The following tables summarize the collision detection behavior of the dual-port RAMB16 based on the WRITE\_MODE\_A and WRITE\_MODE\_B settings.

WRITE\_MODE\_A=NO\_CHANGE and WRITE\_MODE\_B=NO\_CHANGE

WEA	WEB	CLKA	CLKB	DIA	DIB	DIPA	DIPB	DOA	DOB	DOPA	DOPB	Data RAM	Parity Ram
0	0	↑	↑	DIA	DIB	DIPA	DIPB	RAM	RAM	RAM	RAM	No Change	No Change
1	0	↑	↑	DIA	DIB	DIPA	DIPB	No Change	X	No Change	X	DIA	DIPA
0	1	↑	↑	DIA	DIB	DIPA	DIPB	X	No Change	X	No Change	DIB	DIPB
1	1	↑	↑	DIA	DIB	DIPA	DIPB	No Change	No Change	No Change	No Change	X	X

*WRITE\_MODE\_A=READ\_FIRST and WRITE\_MODE\_B=READ\_FIRST*

WEA	WEB	CLKA	CLKB	DIA	DIB	DIPA	DIPB	DOA	DOB	DOPA	DOPB	Data RAM	Parity Ram
0	0	↑	↑	DIA	DIB	DIPA	DIPB	RAM	RAM	RAM	RAM	No Change	No Change
1	0	↑	↑	DIA	DIB	DIPA	DIPB	RAM	RAM	RAM	RAM	DIA	DIPA
0	1	↑	↑	DIA	DIB	DIPA	DIPB	RAM	RAM	RAM	RAM	DIB	DIPB
1	1	↑	↑	DIA	DIB	DIPA	DIPB	RAM	RAM	RAM	RAM	X	X

*WRITE\_MODE\_A=WRITE\_FIRST and WRITE\_MODE\_B=WRITE\_FIRST*

WEA	WEB	CLKA	CLKB	DIA	DIB	DIPA	DIPB	DOA	DOB	DOPA	DOPB	Data RAM	Parity Ram
0	0	↑	↑	DIA	DIB	DIPA	DIPB	RAM	RAM	RAM	RAM	No Change	No Change
1	0	↑	↑	DIA	DIB	DIPA	DIPB	DIA	X	DIPA	X	DIA	DIPA
0	1	↑	↑	DIA	DIB	DIPA	DIPB	X	DIB	X	DIPB	DIB	DIPB
1	1	↑	↑	DIA	DIB	DIPA	DIPB	X	X	X	X	X	X

*WRITE\_MODE\_A=NO\_CHANGE and WRITE\_MODE\_B=READ\_FIRST*

WEA	WEB	CLKA	CLKB	DIA	DIB	DIPA	DIPB	DOA	DOB	DOPA	DOPB	Data RAM	Parity Ram
0	0	↑	↑	DIA	DIB	DIPA	DIPB	RAM	RAM	RAM	RAM	No Change	No Change
1	0	↑	↑	DIA	DIB	DIPA	DIPB	No Change	X	No Change	X	DIA	DIPA
0	1	↑	↑	DIA	DIB	DIPA	DIPB	RAM	RAM	RAM	RAM	DIB	DIPB
1	1	↑	↑	DIA	DIB	DIPA	DIPB	No Change	X	No Change	X	DIB	DIPB

*WRITE\_MODE\_A=NO\_CHANGE and WRITE\_MODE\_B=WRITE\_FIRST*

WEA	WEB	CLKA	CLKB	DIA	DIB	DIPA	DIPB	DOA	DOB	DOPA	DOPB	Data RAM	Parity Ram
0	0	↑	↑	DIA	DIB	DIPA	DIPB	RAM	RAM	RAM	RAM	No Change	No Change
1	0	↑	↑	DIA	DIB	DIPA	DIPB	No Change	X	No Change	X	DIA	DIPA

WEA	WEB	CLKA	CLKB	DIA	DIB	DIPA	DIPB	DOA	DOB	DOPA	DOPB	Data RAM	Parity Ram
0	1	↑	↑	DIA	DIB	DIPA	DIPB	X	DIB	X	DIPB	DIB	DIPB
1	1	↑	↑	DIA	DIB	DIPA	DIPB	No Change	X	No Change	X	X	X

*WRITE\_MODE\_A=READ\_FIRST and WRITE\_MODE\_B=WRITE\_FIRST*

WEA	WEB	CLKA	CLKB	DIA	DIB	DIPA	DIPB	DOA	DOB	DOPA	DOPB	Data RAM	Parity Ram
0	0	↑	↑	DIA	DIB	DIPA	DIPB	RAM	RAM	RAM	RAM	No Change	No Change
1	0	↑	↑	DIA	DIB	DIPA	DIPB	RAM	RAM	RAM	RAM	DIA	DIPA
0	1	↑	↑	DIA	DIB	DIPA	DIPB	X	DIB	X	DIPB	DIB	DIPB
1	1	↑	↑	DIA	DIB	DIPA	DIPB	X	DIB	X	DIPB	DIA	DIPA

## Design Entry Method

This design element can be used in schematics.

## Available Attributes

Attribute	Type	Allowed Values	Default	Description
INIT_00 To INIT_3F	Binary/Hexadecimal	Any	All zeros	Specifies the initial contents of the data portion of the RAM array.
INIT_A	Binary/Hexadecimal	Any	All zeros	Identifies the initial value of the DOA/DOB output port after completing configuration. For Type, the bit width is dependent on the width of the A or B port of the RAM.
INIT_B	Binary/Hexadecimal	Any	All zeros	Identifies the initial value of the DOA/DOB output port after completing configuration. For Type, the bit width is dependent on the width of the A or B port of the RAM.
INITP_00 To INITP_07	Binary/Hexadecimal	Any	All zeros	Specifies the initial contents of the parity portion of the RAM array.
SIM_COLLISION_CHECK	String	"ALL", "NONE", "WARNING", or "GENERATE_X_ONLY"	"ALL"	Specifies the behavior during simulation in the event of a data collision (data being read or written to the same address from both ports of the Ram simultaneously. "ALL" issues a warning to simulator console and generate an X or all unknown data due to the collision. This is the recommended setting. "WARNING" generates a warning only and "GENERATE_X_ONLY" generates an X for unknown data but won't output the occurrence to the simulation console. "NONE" completely ignores the error. It is suggested to only change this attribute if you can ensure the data generated during a collision is discarded.

Attribute	Type	Allowed Values	Default	Description
SRVAL_A	Binary/Hexadecimal	Any	All zeros	Allows the individual selection of whether the DOA/DOB output port sets (go to a one) or reset (go to a zero) upon the assertion of the RSTA pin. For Type, the bit width is dependent on the width of the A port of the RAM.
SRVAL_B	Binary/Hexadecimal	Any	All zeros	Allows the individual selection of whether the DOA/DOB output port sets (go to a one) or reset (go to a zero) upon the assertion of the RSTB pin. For Type, the bit width is dependent on the width of the B port of the RAM.
WRITE_MODE_A	String	"WRITE_FIRST", "READ_FIRST" or "NO_CHANGE"	"WRITE_FIRST"	Specifies the behavior of the DOA/DOB port upon a write command to the respected port. If set to WRITE_FIRST, the same port that is written to displays the contents of the written data to the outputs upon completion of the operation. "READ_FIRST" displays the prior contents of the RAM to the output port prior to writing the new data. "NO_CHANGE" keeps the previous value on the output port and won't update the output port upon a write command. This is the suggested mode if not using the read data from a particular port of the RAM
WRITE_MODE_B	String	"WRITE_FIRST", "READ_FIRST" or "NO_CHANGE"	"WRITE_FIRST"	Specifies the behavior of the DOA/DOB port upon a write command to the respected port. If set to WRITE_FIRST, the same port that is written to displays the contents of the written data to the outputs upon completion of the operation. "READ_FIRST" displays the prior contents of the RAM to the output port prior to writing the new data. "NO_CHANGE" keeps the previous value on the output port and won't update the output port upon a write command. This is the suggested mode if not using the read data from a particular port of the RAM.

## For More Information

- See the [Spartan-3 User Guide](#).
- See the [Spartan-3 Data Sheets](#).

# RAMB16\_S2

Primitive: 16K-bit Data and 2K-bit Parity Single-Port Synchronous Block RAM with 2-bit Port

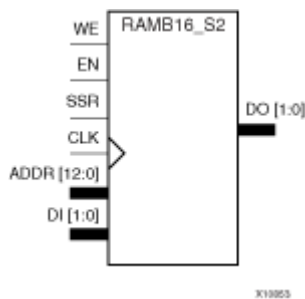

## Introduction

This design element is a dedicated random access memory blocks with synchronous write capability. The block RAM port has 16384 bits of data memory.

The enable ENA pin controls read, write, and reset for Port A. When ENA is Low, no data is written and the outputs (DOA and DOPA) retain the last state. When ENA is High and reset (SSRA) is High, DOA and DOPA are set to SRVAL\_A during the Low-to-High clock (CLKA) transition; if write enable (WEA) is High, the memory contents reflect the data at DIA and DIPA. When ENA is High and WEA is Low, the data stored in the RAM address (ADDRA) is read during the Low-to-High clock transition. By default, WRITE\_MODE\_A=WRITE\_FIRST, when ENA and WEA are High, the data on the data inputs (DIA and DIPA) is loaded into the word selected by the write address (ADDRA) during the Low-to-High clock transition and the data outputs (DOA and DOPA) reflect the selected (addressed) word.

The above description assumes an active High EN, WE, SSR, and CLK. However, the active level can be changed by placing an inverter on the port. Any inverter placed on a RAMB16 port is absorbed into the block and does not use a CLB resource.

The cell configuration for this element is listed in the following table.

	Data Cells		Parity Cells				
Component	Depth	Width	Depth	Width	Address Bus	Data Bus	Parity Bus
RAMB16_S2	8192	2	-	-	(12:0)	(1:0)	-

## Available Attributes

Attribute	Type	Allowed Values	Default	Description
INIT	Binary	Any Hex Value	All zeros	Identifies the initial value of the DO output port after completing configuration. The bit width is dependent on the width of the A or B port of the RAM.
INIT_00 - INIT_3F	Binary	Any Hex Value	All zeros	Specifies the initial contents of the data portion of the RAM array.
INITP_00 - INITP_07	Binary	Any Hex Value	All zeros	Specifies the initial contents of the parity portion of the RAM array.

Attribute	Type	Allowed Values	Default	Description
SRVAL	Binary	Any Hex Value	All zeros	Allows the individual selection of whether the DO output port sets (go to a one) or reset (go to a zero) upon the assertion of the SSR pin. The bit width is dependent on the width of the A or B port of the RAM.
WRITE_MODE	String	"WRITE_FIRST", "READ_FIRST" or "NO_CHANGE"	"WRITE_FIRST"	Specifies the behavior of the DO port upon a write command to the respected port. If set to "WRITE_FIRST", the same port that is written to displays the contents of the written data to the outputs upon completion of the operation. "READ_FIRST" displays the prior contents of the RAM to the output port prior to writing the new data. "NO_CHANGE" keeps the previous value on the output port and won't update the output port upon a write command. This is the suggested mode if not using the read data from a particular port of the RAM.

### For More Information

- See the [Spartan-3 User Guide](#).
- See the [Spartan-3 Data Sheets](#).



# RAMB16\_S2\_S18

Primitive: 16K-bit Data and 2K-bit Parity Dual-Port Synchronous Block RAM with 2-bit and 18-bit Ports

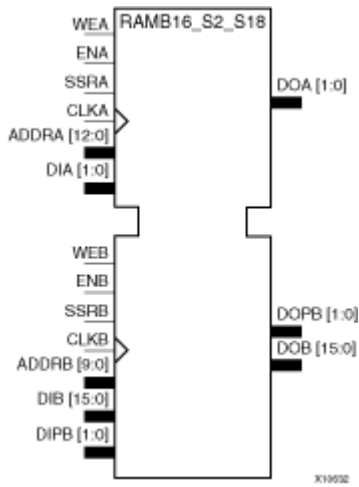

## Introduction

This design element is a dual-ported dedicated random access memory block with synchronous write capability. Each block RAM port has 16384 bits of data memory. Ports configured as 9, 18, or 36-bits wide have an additional 2048 bits of parity memory. Each port is independent of the other while accessing the same set of 16384 data memory cells. Each port is independently configured to a specific data width. The possible port and cell configurations for this element are listed under "Port Descriptions."

## Logic Table

Truth Table A

Inputs								Outputs			
GSR	ENA	SSRA	WEA	CLKA	ADDRa	DIA	DIPa	DOA	DOPA	RAM Contents	
										Data RAM	Parity RAM
1	X	X	X	X	X	X	X	INIT_A	INIT_A	No Change	No Change
0	0	X	X	X	X	X	X	No Change	No Change	No Change	No Change
0	1	1	0	↑	X	X	X	SRVAL_A	SRVAL_A	No Change	No Change
0	1	1	1	↑	addr	data	pdata	SRVAL_A	SRVAL_A	RAM(addr) =>data	RAM(addr) =>pdata
0	1	0	0	↑	addr	X	X	RAM(addr)	RAM(addr)	No Change	No Change

Inputs								Outputs			
GSR	ENA	SSRA	WEA	CLKA	ADDRA	DIA	DIPA	DOA	DOPA	RAM Contents	
										Data RAM	Parity RAM
0	1	0	1	↑	addr	data	pdata	No Change1, RAM (addr)2, data3	No Change1, RAM (addr)2, pdata3	RAM(addr) =>data	RAM(addr) =>pdata

GSR=Global Set Reset  
 INIT\_A=Value specified by the INIT\_A attribute for output register. Default is all zeros.  
 SRVAL\_A=register value.  
 addr=RAM address.  
 RAM(addr)=RAM contents at address ADDR.  
 data=RAM input data.  
 pdata=RAM parity data.  
 1WRITE\_MODE\_A=NO\_CHANGE.  
 2WRITE\_MODE\_A=READ\_FIRST.  
 3WRITE\_MODE\_A=WRITE\_FIRST.

Truth Table B

Inputs								Outputs			
GSR	ENB	SSRB	WEB	CLKB	ADDRB	DIB	DIPB	DOB	DOPB	RAM Contents	
										Data RAM	Parity RAM
1	X	X	X	X	X	X	X	INIT_B	INIT_B	No Change	No Change
0	0	X	X	X	X	X	X	No Change	No Change	No Change	No Change
0	1	1	0	↑	X	X	X	SRVAL_B	SRVAL_B	No Change	No Change
0	1	1	1	↑	addr	data	pdata	SRVAL_B	SRVAL_B	RAM(addr) =>data	RAM(addr) =>pdata
0	1	0	0	↑	addr	X	X	RAM(addr)	RAM(addr)	No Change	No Change
0	1	0	1	↑	addr	data	pdata	No Change1, RAM (addr)2, data3	No Change1, RAM (addr)2, pdata3	RAM(addr)2	RAM(addr) =>pdata

GSR=Global Set Reset.  
 INIT\_B=Value specified by the INIT\_B attribute for output registers. Default is all zeros.  
 SRVAL\_B=register value.  
 addr=RAM address.  
 RAM(addr)=RAM contents at address ADDR.  
 data=RAM input data.  
 pdata=RAM parity data.  
 1WRITE\_MODE\_B=NO\_CHANGE.  
 2WRITE\_MODE\_B=READ\_FIRST.  
 3WRITE\_MODE\_B=WRITE\_FIRST.

## Port Descriptions

Port A						Port B				
Design Element	Data Cells(a)	Parity Cells(a)	Address Bus	Data Bus	Parity Bus	Data Cells(a)	Parity Cells(a)	Address Bus	Data Bus	Parity Bus
RAMB16_S2_S18	8192 x 2	-	(12:0)	(1:0)	-	1024 x 16	1024 x 2	(9:0)	(15:0)	(1:0)
(a)Depth x Width										

Each port is fully synchronous with independent clock pins. All Port A input pins have setup time referenced to the CLKA pin and its data output bus DOA has a clock-to-out time referenced to the CLKA. All Port B input pins have setup time referenced to the CLKB pin and its data output bus DOB has a clock-to-out time referenced to the CLKB. The enable ENA pin controls read, write, and reset for Port A. When ENA is Low, no data is written and the outputs (DOA and DOPA) retain the last state. When ENA is High and reset (SSRA) is High, DOA and DOPA are set to SRVAL\_A during the Low-to-High clock (CLKA) transition; if write enable (WEA) is High, the memory contents reflect the data at DIA and DIPA. When ENA is High and WEA is Low, the data stored in the RAM address (ADDRA) is read during the Low-to-High clock transition. By default, WRITE\_MODE\_A=WRITE\_FIRST, when ENA and WEA are High, the data on the data inputs (DIA and DIPA) is loaded into the word selected by the write address (ADDRA) during the Low-to-High clock transition and the data outputs (DOA and DOPA) reflect the selected (addressed) word.

The enable ENB pin controls read, write, and reset for Port B. When ENB is Low, no data is written and the outputs (DOB and DOPB) retain the last state. When ENB is High and reset (SSRB) is High, DOB and DOPB are set to SRVAL\_B during the Low-to-High clock (CLKB) transition; if write enable (WEB) is High, the memory contents reflect the data at DIB and DIPB. When ENB is High and WEB is Low, the data stored in the RAM address (ADDRB) is read during the Low-to-High clock transition. By default, WRITE\_MODE\_B=WRITE\_FIRST, when ENB and WEB are High, the data on the data inputs (DIB and DIPB) are loaded into the word selected by the write address (ADDRB) during the Low-to-High clock transition and the data outputs (DOB and DOPB) reflect the selected (addressed) word. The above descriptions assume active High control pins (ENA, WEA, SSRA, CLKA, ENB, WEB, SSRB, and CLKB). However, the active level can be changed by placing an inverter on the port. Any inverter placed on a RAMB16 port is absorbed into the block and does not use a CLB resource.

### Address Mapping

Each port accesses the same set of 18432 memory cells using an addressing scheme that is dependent on the width of the port. For all port widths, 16384 memory cells are available for data as shown in the "Port Address Mapping for Data" table below. For 9-, 18-, and 36-bit wide ports, 2408 parity memory cells are also available as shown in "Port Address Mapping for Parity" table below. The physical RAM location that is addressed for a particular width is determined from the following formula.

$$\text{Start} = ((\text{ADDR}_{\text{port}} + 1) * (\text{Width}_{\text{port}})) - 1$$

$$\text{End} = (\text{ADDR}_{\text{port}}) * (\text{Width}_{\text{port}})$$

The following tables shows address mapping for each port width.

### Port Address Mapping for Data

Data Width	Port Data Addresses
1	16384 <-- 31 30 29 28 27 26 25 24 23 22 21 20 19 18 17 16 15 14 13 12 11 10 9 8 7 6 5 4 3 2 1 0
2	8192 <-- 15 14 13 12 11 10 9 8 7 6 5 4 3 2 1 0
4	4096 <-- 7 6 5 4 3 2 1 0
8	2048 <-- 3 2 1 0
16	1024 <-- 1 0
32	512 <-- 0

### Port Address Mapping for Parity

Parity Width	Port Parity Addresses																
1	2048	<-----	3					2					1				0
2	1024	<-----	1										0				
4	512	<-----	0														

#### Initializing Memory Contents of a Dual-Port RAMB16

You can use the INIT\_XX attributes to specify an initialization value for the memory contents of a RAMB16 during device configuration. The initialization of each RAMB16\_Sm\_Sn is set by 64 initialization attributes (INIT\_00 through INIT\_3F) of 64 hex values for a total of 16384 bits.

You can use the INITP\_XX attributes to specify an initial value for the parity memory during device configuration or assertion. The initialization of the parity memory for ports configured for 9, 18, or 36 bits is set by 8 initialization attributes (INITP\_00 through INITP\_07) of 64 hex values for a total of 2048 bits.

If any INIT\_XX or INITP\_XX attribute is not specified, it is configured as zeros. Partial Strings are padded with zeros to the left.

#### Initializing the Output Register of a Dual-Port RAMB16

In Spartan-3A, each bit in an output register can be initialized at power on (when GSR is high) to either a 0 or 1. In addition, the initial state specified for power on can be different than the state that results from assertion of a set/reset. Four properties control initialization of the output register for a dual-port RAMB16: INIT\_A, INIT\_B, SRVAL\_A, and SRVAL\_B. The INIT\_A attribute specifies the output register value at power on for Port A and the INIT\_B attribute specifies the value for Port B. You can use the SRVAL\_A attribute to define the state resulting from assertion of the SSR (set/reset) input on Port A. You can use the SRVAL\_B attribute to define the state resulting from assertion of the SSR input on Port B.

The INIT\_A, INIT\_B, SRVAL\_A, and SRVAL\_B attributes specify the initialization value as a hexadecimal String. The value is dependent upon the port width. For example, for a RAMB16\_S1\_S4 with Port A width equal to 1 and Port B width equal to 4, the Port A output register contains 1 bit and the Port B output register contains 4 bits. Therefore, the INIT\_A or SRVAL\_A value can only be specified as a 1 or 0. For Port B, the output register contains 4 bits. In this case, you can use INIT\_B or SRVAL\_B to specify a hexadecimal value from 0 through F to initialize the 4 bits of the output register.

For those ports that include parity bits, the parity portion of the output register is specified in the high order bit position of the INIT\_A, INIT\_B, SRVAL\_A, or SRVAL\_B value.

The INIT and SRVAL attributes default to zero if they are not set by you.

#### Write Mode Selection

The WRITE\_MODE\_A attribute controls the memory and output contents of Port A for a dual-port RAMB16. The WRITE\_MODE\_B attribute does the same for Port B. By default, both WRITE\_MODE\_A and WRITE\_MODE\_B are set to WRITE\_FIRST. This means that input is read, written to memory, and then passed to output. You can set the write mode for Port A and Port B to READ\_FIRST to read the memory contents, pass the memory contents to the outputs, and then write the input to memory. Or, you can set the write mode to NO\_CHANGE to have the input written to memory without changing the output. The "Port A and Port B Conflict Resolution" section describes how read/write conflicts are resolved when both Port A and Port B are attempting to read/write to the same memory cells.

#### Port A and Port B Conflict Resolution

Spartan-3A block SelectRAM is True Dual-Port RAM that allows both ports to simultaneously access the same memory cell. When one port writes to a given memory cell, the other port must not address that memory cell (for a write or a read) within the clock-to-clock setup window.

The following tables summarize the collision detection behavior of the dual-port RAMB16 based on the WRITE\_MODE\_A and WRITE\_MODE\_B settings.

*WRITE\_MODE\_A=NO\_CHANGE and WRITE\_MODE\_B=NO\_CHANGE*

WEA	WEB	CLKA	CLKB	DIA	DIB	DIPA	DIPB	DOA	DOB	DOPA	DOPB	Data RAM	Parity Ram
0	0	↑	↑	DIA	DIB	DIPA	DIPB	RAM	RAM	RAM	RAM	No Change	No Change
1	0	↑	↑	DIA	DIB	DIPA	DIPB	No Change	X	No Change	X	DIA	DIPA
0	1	↑	↑	DIA	DIB	DIPA	DIPB	X	No Change	X	No Change	DIB	DIPB
1	1	↑	↑	DIA	DIB	DIPA	DIPB	No Change	No Change	No Change	No Change	X	X

WRITE\_MODE\_A=READ\_FIRST and WRITE\_MODE\_B=READ\_FIRST

WEA	WEB	CLKA	CLKB	DIA	DIB	DIPA	DIPB	DOA	DOB	DOPA	DOPB	Data RAM	Parity Ram
0	0	↑	↑	DIA	DIB	DIPA	DIPB	RAM	RAM	RAM	RAM	No Change	No Change
1	0	↑	↑	DIA	DIB	DIPA	DIPB	RAM	RAM	RAM	RAM	DIA	DIPA
0	1	↑	↑	DIA	DIB	DIPA	DIPB	RAM	RAM	RAM	RAM	DIB	DIPB
1	1	↑	↑	DIA	DIB	DIPA	DIPB	RAM	RAM	RAM	RAM	X	X

WRITE\_MODE\_A= WRITE\_FIRST and WRITE\_MODE\_B=WRITE\_FIRST

WEA	WEB	CLKA	CLKB	DIA	DIB	DIPA	DIPB	DOA	DOB	DOPA	DOPB	Data RAM	Parity Ram
0	0	↑	↑	DIA	DIB	DIPA	DIPB	RAM	RAM	RAM	RAM	No Change	No Change
1	0	↑	↑	DIA	DIB	DIPA	DIPB	DIA	X	DIPA	X	DIA	DIPA
0	1	↑	↑	DIA	DIB	DIPA	DIPB	X	DIB	X	DIPB	DIB	DIPB
1	1	↑	↑	DIA	DIB	DIPA	DIPB	X	X	X	X	X	X

WRITE\_MODE\_A=NO\_CHANGE and WRITE\_MODE\_B=READ\_FIRST

WEA	WEB	CLKA	CLKB	DIA	DIB	DIPA	DIPB	DOA	DOB	DOPA	DOPB	Data RAM	Parity Ram
0	0	↑	↑	DIA	DIB	DIPA	DIPB	RAM	RAM	RAM	RAM	No Change	No Change
1	0	↑	↑	DIA	DIB	DIPA	DIPB	No Change	X	No Change	X	DIA	DIPA
0	1	↑	↑	DIA	DIB	DIPA	DIPB	RAM	RAM	RAM	RAM	DIB	DIPB
1	1	↑	↑	DIA	DIB	DIPA	DIPB	No Change	X	No Change	X	DIB	DIPB

WRITE\_MODE\_A=NO\_CHANGE and WRITE\_MODE\_B=WRITE\_FIRST

WEA	WEB	CLKA	CLKB	DIA	DIB	DIPA	DIPB	DOA	DOB	DOPA	DOPB	Data RAM	Parity Ram
0	0	↑	↑	DIA	DIB	DIPA	DIPB	RAM	RAM	RAM	RAM	No Change	No Change
1	0	↑	↑	DIA	DIB	DIPA	DIPB	No Change	X	No Change	X	DIA	DIPA

WEA	WEB	CLKA	CLKB	DIA	DIB	DIPA	DIPB	DOA	DOB	DOPA	DOPB	Data RAM	Parity Ram
0	1	↑	↑	DIA	DIB	DIPA	DIPB	X	DIB	X	DIPB	DIB	DIPB
1	1	↑	↑	DIA	DIB	DIPA	DIPB	No Change	X	No Change	X	X	X

*WRITE\_MODE\_A=READ\_FIRST and WRITE\_MODE\_B=WRITE\_FIRST*

WEA	WEB	CLKA	CLKB	DIA	DIB	DIPA	DIPB	DOA	DOB	DOPA	DOPB	Data RAM	Parity Ram
0	0	↑	↑	DIA	DIB	DIPA	DIPB	RAM	RAM	RAM	RAM	No Change	No Change
1	0	↑	↑	DIA	DIB	DIPA	DIPB	RAM	RAM	RAM	RAM	DIA	DIPA
0	1	↑	↑	DIA	DIB	DIPA	DIPB	X	DIB	X	DIPB	DIB	DIPB
1	1	↑	↑	DIA	DIB	DIPA	DIPB	X	DIB	X	DIPB	DIA	DIPA

## Design Entry Method

This design element can be used in schematics.

## Available Attributes

Attribute	Type	Allowed Values	Default	Description
INIT_00 To INIT_3F	Binary/Hexadecimal	Any	All zeros	Specifies the initial contents of the data portion of the RAM array.
INIT_A	Binary/Hexadecimal	Any	All zeros	Identifies the initial value of the DOA/DOB output port after completing configuration. For Type, the bit width is dependent on the width of the A or B port of the RAM.
INIT_B	Binary/Hexadecimal	Any	All zeros	Identifies the initial value of the DOA/DOB output port after completing configuration. For Type, the bit width is dependent on the width of the A or B port of the RAM.
INITP_00 To INITP_07	Binary/Hexadecimal	Any	All zeros	Specifies the initial contents of the parity portion of the RAM array.
SIM_COLLISION_CHECK	String	"ALL", "NONE", "WARNING", or "GENERATE_X_ONLY"	"ALL"	Specifies the behavior during simulation in the event of a data collision (data being read or written to the same address from both ports of the Ram simultaneously. "ALL" issues a warning to simulator console and generate an X or all unknown data due to the collision. This is the recommended setting. "WARNING" generates a warning only and "GENERATE_X_ONLY" generates an X for unknown data but won't output the occurrence to the simulation console. "NONE" completely ignores the error. It is suggested to only change this attribute if you can ensure the data generated during a collision is discarded.

Attribute	Type	Allowed Values	Default	Description
SRVAL_A	Binary/Hexadecimal	Any	All zeros	Allows the individual selection of whether the DOA/DOB output port sets (go to a one) or reset (go to a zero) upon the assertion of the RSTA pin. For Type, the bit width is dependent on the width of the A port of the RAM.
SRVAL_B	Binary/Hexadecimal	Any	All zeros	Allows the individual selection of whether the DOA/DOB output port sets (go to a one) or reset (go to a zero) upon the assertion of the RSTB pin. For Type, the bit width is dependent on the width of the B port of the RAM.
WRITE_MODE_A	String	"WRITE_FIRST", "READ_FIRST" or "NO_CHANGE"	"WRITE_FIRST"	Specifies the behavior of the DOA/DOB port upon a write command to the respected port. If set to WRITE_FIRST, the same port that is written to displays the contents of the written data to the outputs upon completion of the operation. "READ_FIRST" displays the prior contents of the RAM to the output port prior to writing the new data. "NO_CHANGE" keeps the previous value on the output port and won't update the output port upon a write command. This is the suggested mode if not using the read data from a particular port of the RAM
WRITE_MODE_B	String	"WRITE_FIRST", "READ_FIRST" or "NO_CHANGE"	"WRITE_FIRST"	Specifies the behavior of the DOA/DOB port upon a write command to the respected port. If set to WRITE_FIRST, the same port that is written to displays the contents of the written data to the outputs upon completion of the operation. "READ_FIRST" displays the prior contents of the RAM to the output port prior to writing the new data. "NO_CHANGE" keeps the previous value on the output port and won't update the output port upon a write command. This is the suggested mode if not using the read data from a particular port of the RAM.

## For More Information

- See the [Spartan-3 User Guide](#).
- See the [Spartan-3 Data Sheets](#).

## RAMB16\_S2\_S2

Primitive: 16K-bit Data and 2K-bit Parity Dual-Port Synchronous Block RAM with 2-bit Ports

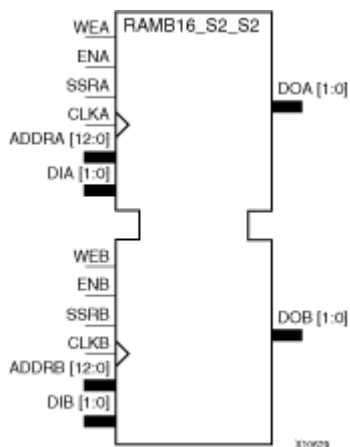

### Introduction

This design element is a dual-ported dedicated random access memory block with synchronous write capability. Each block RAM port has 16384 bits of data memory. Ports configured as 9, 18, or 36-bits wide have an additional 2048 bits of parity memory. Each port is independent of the other while accessing the same set of 16384 data memory cells. Each port is independently configured to a specific data width. The possible port and cell configurations for this element are listed under "Port Descriptions."

### Logic Table

Truth Table A

Inputs								Outputs			
GSR	ENA	SSRA	WEA	CLKA	ADDR_A	DIA	DIPA	DOA	DOPA	RAM Contents	
										Data RAM	Parity RAM
1	X	X	X	X	X	X	X	INIT_A	INIT_A	No Change	No Change
0	0	X	X	X	X	X	X	No Change	No Change	No Change	No Change
0	1	1	0	↑	X	X	X	SRVAL_A	SRVAL_A	No Change	No Change
0	1	1	1	↑	addr	data	pdata	SRVAL_A	SRVAL_A	RAM(addr) =>data	RAM(addr) =>pdata
0	1	0	0	↑	addr	X	X	RAM(addr)	RAM(addr)	No Change	No Change



Inputs								Outputs			
GSR	ENA	SSRA	WEA	CLKA	ADDRA	DIA	DIPA	DOA	DOPA	RAM Contents	
										Data RAM	Parity RAM
0	1	0	1	↑	addr	data	pdata	No Change1, RAM (addr)2, data3	No Change1, RAM (addr)2, pdata3	RAM(addr) =>data	RAM(addr) =>pdata

GSR=Global Set Reset  
 INIT\_A=Value specified by the INIT\_A attribute for output register. Default is all zeros.  
 SRVAL\_A=register value.  
 addr=RAM address.  
 RAM(addr)=RAM contents at address ADDR.  
 data=RAM input data.  
 pdata=RAM parity data.  
 1WRITE\_MODE\_A=NO\_CHANGE.  
 2WRITE\_MODE\_A=READ\_FIRST.  
 3WRITE\_MODE\_A=WRITE\_FIRST.

Truth Table B

Inputs								Outputs			
GSR	ENB	SSRB	WEB	CLKB	ADDRB	DIB	DIPB	DOB	DOPB	RAM Contents	
										Data RAM	Parity RAM
1	X	X	X	X	X	X	X	INIT_B	INIT_B	No Change	No Change
0	0	X	X	X	X	X	X	No Change	No Change	No Change	No Change
0	1	1	0	↑	X	X	X	SRVAL_B	SRVAL_B	No Change	No Change
0	1	1	1	↑	addr	data	pdata	SRVAL_B	SRVAL_B	RAM(addr) =>data	RAM(addr) =>pdata
0	1	0	0	↑	addr	X	X	RAM(addr)	RAM(addr)	No Change	No Change
0	1	0	1	↑	addr	data	pdata	No Change1, RAM (addr)2, data3	No Change1, RAM (addr)2, pdata3	RAM(addr)2	RAM(addr) =>pdata

GSR=Global Set Reset.  
 INIT\_B=Value specified by the INIT\_B attribute for output registers. Default is all zeros.  
 SRVAL\_B=register value.  
 addr=RAM address.  
 RAM(addr)=RAM contents at address ADDR.  
 data=RAM input data.  
 pdata=RAM parity data.  
 1WRITE\_MODE\_B=NO\_CHANGE.  
 2WRITE\_MODE\_B=READ\_FIRST.

See the ISE 10.1 User Guide for Schematic Designs

## Port Descriptions

Port A						Port B				
Design Element	Data Cells(a)	Parity Cells(a)	Address Bus	Data Bus	Parity Bus	Data Cells(a)	Parity Cells(a)	Address Bus	Data Bus	Parity Bus
RAMB16_S2_S2	8192 x 2	-	(12:0)	(1:0)	-	8192 x 2	-	(12:0)	(1:0)	-
(a)Depth x Width										

Each port is fully synchronous with independent clock pins. All Port A input pins have setup time referenced to the CLKA pin and its data output bus DOA has a clock-to-out time referenced to the CLKA. All Port B input pins have setup time referenced to the CLKB pin and its data output bus DOB has a clock-to-out time referenced to the CLKB. The enable ENA pin controls read, write, and reset for Port A. When ENA is Low, no data is written and the outputs (DOA and DOPA) retain the last state. When ENA is High and reset (SSRA) is High, DOA and DOPA are set to SRVAL\_A during the Low-to-High clock (CLKA) transition; if write enable (WEA) is High, the memory contents reflect the data at DIA and DIPA. When ENA is High and WEA is Low, the data stored in the RAM address (ADDRA) is read during the Low-to-High clock transition. By default, WRITE\_MODE\_A=WRITE\_FIRST, when ENA and WEA are High, the data on the data inputs (DIA and DIPA) is loaded into the word selected by the write address (ADDRA) during the Low-to-High clock transition and the data outputs (DOA and DOPA) reflect the selected (addressed) word.

The enable ENB pin controls read, write, and reset for Port B. When ENB is Low, no data is written and the outputs (DOB and DOPB) retain the last state. When ENB is High and reset (SSRB) is High, DOB and DOPB are set to SRVAL\_B during the Low-to-High clock (CLKB) transition; if write enable (WEB) is High, the memory contents reflect the data at DIB and DIPB. When ENB is High and WEB is Low, the data stored in the RAM address (ADDRB) is read during the Low-to-High clock transition. By default, WRITE\_MODE\_B=WRITE\_FIRST, when ENB and WEB are High, the data on the data inputs (DIB and DIPB) are loaded into the word selected by the write address (ADDRB) during the Low-to-High clock transition and the data outputs (DOB and DOPB) reflect the selected (addressed) word. The above descriptions assume active High control pins (ENA, WEA, SSRA, CLKA, ENB, WEB, SSRB, and CLKB). However, the active level can be changed by placing an inverter on the port. Any inverter placed on a RAMB16 port is absorbed into the block and does not use a CLB resource.

### Address Mapping

Each port accesses the same set of 18432 memory cells using an addressing scheme that is dependent on the width of the port. For all port widths, 16384 memory cells are available for data as shown in the "Port Address Mapping for Data" table below. For 9-, 18-, and 36-bit wide ports, 2408 parity memory cells are also available as shown in "Port Address Mapping for Parity" table below. The physical RAM location that is addressed for a particular width is determined from the following formula.

$$\text{Start} = ((\text{ADDR}_{\text{port}} + 1) * (\text{Width}_{\text{port}})) - 1$$

$$\text{End} = (\text{ADDR}_{\text{port}}) * (\text{Width}_{\text{port}})$$

The following tables shows address mapping for each port width.

### Port Address Mapping for Data

Data Width	Port Data Addresses	31	30	29	28	27	26	25	24	23	22	21	20	19	18	17	16	15	14	13	12	11	10	9	8	7	6	5	4	3	2	1	0		
1	16384	<--																																	
2	8192	<--	15		14		13		12		11		10		9		8		7		6		5		4		3		2		1		0		
4	4096	<--	7			6				5				4								2				1					0				
8	2048	<--	3							2																0									
16	1024	<--	1																																
32	512	<--	0																																

### Port Address Mapping for Parity

Parity Width	Port Parity Addresses																
1	2048	<-----	3					2					1				0
2	1024	<-----	1										0				
4	512	<-----	0														

#### Initializing Memory Contents of a Dual-Port RAMB16

You can use the INIT\_XX attributes to specify an initialization value for the memory contents of a RAMB16 during device configuration. The initialization of each RAMB16\_Sm\_Sn is set by 64 initialization attributes (INIT\_00 through INIT\_3F) of 64 hex values for a total of 16384 bits.

You can use the INITP\_XX attributes to specify an initial value for the parity memory during device configuration or assertion. The initialization of the parity memory for ports configured for 9, 18, or 36 bits is set by 8 initialization attributes (INITP\_00 through INITP\_07) of 64 hex values for a total of 2048 bits.

If any INIT\_XX or INITP\_XX attribute is not specified, it is configured as zeros. Partial Strings are padded with zeros to the left.

#### Initializing the Output Register of a Dual-Port RAMB16

In Spartan-3A, each bit in an output register can be initialized at power on (when GSR is high) to either a 0 or 1. In addition, the initial state specified for power on can be different than the state that results from assertion of a set/reset. Four properties control initialization of the output register for a dual-port RAMB16: INIT\_A, INIT\_B, SRVAL\_A, and SRVAL\_B. The INIT\_A attribute specifies the output register value at power on for Port A and the INIT\_B attribute specifies the value for Port B. You can use the SRVAL\_A attribute to define the state resulting from assertion of the SSR (set/reset) input on Port A. You can use the SRVAL\_B attribute to define the state resulting from assertion of the SSR input on Port B.

The INIT\_A, INIT\_B, SRVAL\_A, and SRVAL\_B attributes specify the initialization value as a hexadecimal String. The value is dependent upon the port width. For example, for a RAMB16\_S1\_S4 with Port A width equal to 1 and Port B width equal to 4, the Port A output register contains 1 bit and the Port B output register contains 4 bits. Therefore, the INIT\_A or SRVAL\_A value can only be specified as a 1 or 0. For Port B, the output register contains 4 bits. In this case, you can use INIT\_B or SRVAL\_B to specify a hexadecimal value from 0 through F to initialize the 4 bits of the output register.

For those ports that include parity bits, the parity portion of the output register is specified in the high order bit position of the INIT\_A, INIT\_B, SRVAL\_A, or SRVAL\_B value.

The INIT and SRVAL attributes default to zero if they are not set by you.

#### Write Mode Selection

The WRITE\_MODE\_A attribute controls the memory and output contents of Port A for a dual-port RAMB16. The WRITE\_MODE\_B attribute does the same for Port B. By default, both WRITE\_MODE\_A and WRITE\_MODE\_B are set to WRITE\_FIRST. This means that input is read, written to memory, and then passed to output. You can set the write mode for Port A and Port B to READ\_FIRST to read the memory contents, pass the memory contents to the outputs, and then write the input to memory. Or, you can set the write mode to NO\_CHANGE to have the input written to memory without changing the output. The "Port A and Port B Conflict Resolution" section describes how read/write conflicts are resolved when both Port A and Port B are attempting to read/write to the same memory cells.

#### Port A and Port B Conflict Resolution

Spartan-3A block SelectRAM is True Dual-Port RAM that allows both ports to simultaneously access the same memory cell. When one port writes to a given memory cell, the other port must not address that memory cell (for a write or a read) within the clock-to-clock setup window.

The following tables summarize the collision detection behavior of the dual-port RAMB16 based on the WRITE\_MODE\_A and WRITE\_MODE\_B settings.

WRITE\_MODE\_A=NO\_CHANGE and WRITE\_MODE\_B=NO\_CHANGE

WEA	WEB	CLKA	CLKB	DIA	DIB	DIPA	DIPB	DOA	DOB	DOPA	DOPB	Data RAM	Parity Ram
0	0	↑	↑	DIA	DIB	DIPA	DIPB	RAM	RAM	RAM	RAM	No Change	No Change
1	0	↑	↑	DIA	DIB	DIPA	DIPB	No Change	X	No Change	X	DIA	DIPA
0	1	↑	↑	DIA	DIB	DIPA	DIPB	X	No Change	X	No Change	DIB	DIPB
1	1	↑	↑	DIA	DIB	DIPA	DIPB	No Change	No Change	No Change	No Change	X	X

*WRITE\_MODE\_A=READ\_FIRST and WRITE\_MODE\_B=READ\_FIRST*

WEA	WEB	CLKA	CLKB	DIA	DIB	DIPA	DIPB	DOA	DOB	DOPA	DOPB	Data RAM	Parity Ram
0	0	↑	↑	DIA	DIB	DIPA	DIPB	RAM	RAM	RAM	RAM	No Change	No Change
1	0	↑	↑	DIA	DIB	DIPA	DIPB	RAM	RAM	RAM	RAM	DIA	DIPA
0	1	↑	↑	DIA	DIB	DIPA	DIPB	RAM	RAM	RAM	RAM	DIB	DIPB
1	1	↑	↑	DIA	DIB	DIPA	DIPB	RAM	RAM	RAM	RAM	X	X

*WRITE\_MODE\_A=WRITE\_FIRST and WRITE\_MODE\_B=WRITE\_FIRST*

WEA	WEB	CLKA	CLKB	DIA	DIB	DIPA	DIPB	DOA	DOB	DOPA	DOPB	Data RAM	Parity Ram
0	0	↑	↑	DIA	DIB	DIPA	DIPB	RAM	RAM	RAM	RAM	No Change	No Change
1	0	↑	↑	DIA	DIB	DIPA	DIPB	DIA	X	DIPA	X	DIA	DIPA
0	1	↑	↑	DIA	DIB	DIPA	DIPB	X	DIB	X	DIPB	DIB	DIPB
1	1	↑	↑	DIA	DIB	DIPA	DIPB	X	X	X	X	X	X

*WRITE\_MODE\_A=NO\_CHANGE and WRITE\_MODE\_B=READ\_FIRST*

WEA	WEB	CLKA	CLKB	DIA	DIB	DIPA	DIPB	DOA	DOB	DOPA	DOPB	Data RAM	Parity Ram
0	0	↑	↑	DIA	DIB	DIPA	DIPB	RAM	RAM	RAM	RAM	No Change	No Change
1	0	↑	↑	DIA	DIB	DIPA	DIPB	No Change	X	No Change	X	DIA	DIPA
0	1	↑	↑	DIA	DIB	DIPA	DIPB	RAM	RAM	RAM	RAM	DIB	DIPB
1	1	↑	↑	DIA	DIB	DIPA	DIPB	No Change	X	No Change	X	DIB	DIPB

*WRITE\_MODE\_A=NO\_CHANGE and WRITE\_MODE\_B=WRITE\_FIRST*

WEA	WEB	CLKA	CLKB	DIA	DIB	DIPA	DIPB	DOA	DOB	DOPA	DOPB	Data RAM	Parity Ram
0	0	↑	↑	DIA	DIB	DIPA	DIPB	RAM	RAM	RAM	RAM	No Change	No Change
1	0	↑	↑	DIA	DIB	DIPA	DIPB	No Change	X	No Change	X	DIA	DIPA

WEA	WEB	CLKA	CLKB	DIA	DIB	DIPA	DIPB	DOA	DOB	DOPA	DOPB	Data RAM	Parity Ram
0	1	↑	↑	DIA	DIB	DIPA	DIPB	X	DIB	X	DIPB	DIB	DIPB
1	1	↑	↑	DIA	DIB	DIPA	DIPB	No Change	X	No Change	X	X	X

WRITE\_MODE\_A=READ\_FIRST and WRITE\_MODE\_B=WRITE\_FIRST

WEA	WEB	CLKA	CLKB	DIA	DIB	DIPA	DIPB	DOA	DOB	DOPA	DOPB	Data RAM	Parity Ram
0	0	↑	↑	DIA	DIB	DIPA	DIPB	RAM	RAM	RAM	RAM	No Change	No Change
1	0	↑	↑	DIA	DIB	DIPA	DIPB	RAM	RAM	RAM	RAM	DIA	DIPA
0	1	↑	↑	DIA	DIB	DIPA	DIPB	X	DIB	X	DIPB	DIB	DIPB
1	1	↑	↑	DIA	DIB	DIPA	DIPB	X	DIB	X	DIPB	DIA	DIPA

## Design Entry Method

This design element can be used in schematics.

## Available Attributes

Attribute	Type	Allowed Values	Default	Description
INIT_00 To INIT_3F	Binary/Hexadecimal	Any	All zeros	Specifies the initial contents of the data portion of the RAM array.
INIT_A	Binary/Hexadecimal	Any	All zeros	Identifies the initial value of the DOA/DOB output port after completing configuration. For Type, the bit width is dependent on the width of the A or B port of the RAM.
INIT_B	Binary/Hexadecimal	Any	All zeros	Identifies the initial value of the DOA/DOB output port after completing configuration. For Type, the bit width is dependent on the width of the A or B port of the RAM.
INITP_00 To INITP_07	Binary/Hexadecimal	Any	All zeros	Specifies the initial contents of the parity portion of the RAM array.
SIM_COLLISION_CHECK	String	"ALL", "NONE", "WARNING", or "GENERATE_X_ONLY"	"ALL"	Specifies the behavior during simulation in the event of a data collision (data being read or written to the same address from both ports of the Ram simultaneously. "ALL" issues a warning to simulator console and generate an X or all unknown data due to the collision. This is the recommended setting. "WARNING" generates a warning only and "GENERATE_X_ONLY" generates an X for unknown data but won't output the occurrence to the simulation console. "NONE" completely ignores the error. It is suggested to only change this attribute if you can ensure the data generated during a collision is discarded.
SRVAL_A	Binary/Hexadecimal	Any	All zeros	Allows the individual selection of whether the DOA/DOB output port sets (go to a one) or reset (go to a zero) upon the assertion of the RSTA pin. For Type, the bit width is dependent on the width of the A port of the RAM.

Attribute	Type	Allowed Values	Default	Description
SRVAL_B	Binary/Hexadecimal	Any	All zeros	Allows the individual selection of whether the DOA/DOB output port sets (go to a one) or reset (go to a zero) upon the assertion of the RSTB pin. For Type, the bit width is dependent on the width of the B port of the RAM.
WRITE_MODE_A	String	"WRITE_FIRST", "READ_FIRST" or "NO_CHANGE"	"WRITE_FIRST"	Specifies the behavior of the DOA/DOB port upon a write command to the respected port. If set to WRITE_FIRST, the same port that is written to displays the contents of the written data to the outputs upon completion of the operation. "READ_FIRST" displays the prior contents of the RAM to the output port prior to writing the new data. "NO_CHANGE" keeps the previous value on the output port and won't update the output port upon a write command. This is the suggested mode if not using the read data from a particular port of the RAM
WRITE_MODE_B	String	"WRITE_FIRST", "READ_FIRST" or "NO_CHANGE"	"WRITE_FIRST"	Specifies the behavior of the DOA/DOB port upon a write command to the respected port. If set to WRITE_FIRST, the same port that is written to displays the contents of the written data to the outputs upon completion of the operation. "READ_FIRST" displays the prior contents of the RAM to the output port prior to writing the new data. "NO_CHANGE" keeps the previous value on the output port and won't update the output port upon a write command. This is the suggested mode if not using the read data from a particular port of the RAM.

## For More Information

- See the [Spartan-3 User Guide](#).
- See the [Spartan-3 Data Sheets](#).

# RAMB16\_S2\_S36

Primitive: 16K-bit Data and 2K-bit Parity Dual-Port Synchronous Block RAM with 2-bit and 36-bit Ports

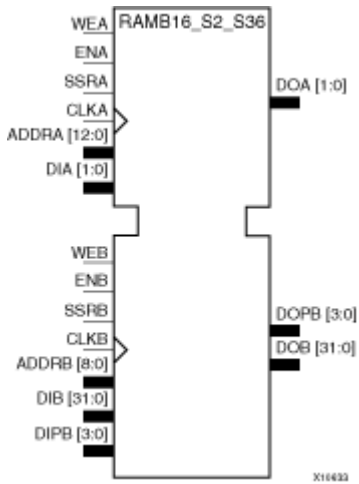

## Introduction

This design element is a dual-ported dedicated random access memory block with synchronous write capability. Each block RAM port has 16384 bits of data memory. Ports configured as 9, 18, or 36-bits wide have an additional 2048 bits of parity memory. Each port is independent of the other while accessing the same set of 16384 data memory cells. Each port is independently configured to a specific data width. The possible port and cell configurations for this element are listed under "Port Descriptions."

## Logic Table

Truth Table A

Inputs								Outputs			
GSR	ENA	SSRA	WEA	CLKA	ADDR_A	DIA	DIPA	DOA	DOPA	RAM Contents	
										Data RAM	Parity RAM
1	X	X	X	X	X	X	X	INIT_A	INIT_A	No Change	No Change
0	0	X	X	X	X	X	X	No Change	No Change	No Change	No Change
0	1	1	0	↑	X	X	X	SRVAL_A	SRVAL_A	No Change	No Change
0	1	1	1	↑	addr	data	pdata	SRVAL_A	SRVAL_A	RAM(addr) =>data	RAM(addr) =>pdata
0	1	0	0	↑	addr	X	X	RAM(addr)	RAM(addr)	No Change	No Change

Inputs								Outputs			
GSR	ENA	SSRA	WEA	CLKA	ADDRA	DIA	DIPA	DOA	DOPA	RAM Contents	
										Data RAM	Parity RAM
0	1	0	1	↑	addr	data	pdata	No Change1, RAM (addr)2, data3	No Change1, RAM (addr)2, pdata3	RAM(addr) =>data	RAM(addr) =>pdata

GSR=Global Set Reset  
 INIT\_A=Value specified by the INIT\_A attribute for output register. Default is all zeros.  
 SRVAL\_A=register value.  
 addr=RAM address.  
 RAM(addr)=RAM contents at address ADDR.  
 data=RAM input data.  
 pdata=RAM parity data.  
 1WRITE\_MODE\_A=NO\_CHANGE.  
 2WRITE\_MODE\_A=READ\_FIRST.  
 3WRITE\_MODE\_A=WRITE\_FIRST.

Truth Table B

Inputs								Outputs			
GSR	ENB	SSRB	WEB	CLKB	ADDRB	DIB	DIPB	DOB	DOPB	RAM Contents	
										Data RAM	Parity RAM
1	X	X	X	X	X	X	X	INIT_B	INIT_B	No Change	No Change
0	0	X	X	X	X	X	X	No Change	No Change	No Change	No Change
0	1	1	0	↑	X	X	X	SRVAL_B	SRVAL_B	No Change	No Change
0	1	1	1	↑	addr	data	pdata	SRVAL_B	SRVAL_B	RAM(addr) =>data	RAM(addr) =>pdata
0	1	0	0	↑	addr	X	X	RAM(addr)	RAM(addr)	No Change	No Change
0	1	0	1	↑	addr	data	pdata	No Change1, RAM (addr)2, data3	No Change1, RAM (addr)2, pdata3	RAM(addr)2	RAM(addr) =>pdata

GSR=Global Set Reset.  
 INIT\_B=Value specified by the INIT\_B attribute for output registers. Default is all zeros.  
 SRVAL\_B=register value.  
 addr=RAM address.  
 RAM(addr)=RAM contents at address ADDR.  
 data=RAM input data.  
 pdata=RAM parity data.  
 1WRITE\_MODE\_B=NO\_CHANGE.  
 2WRITE\_MODE\_B=READ\_FIRST.  
 3WRITE\_MODE\_B=WRITE\_FIRST.



## Port Descriptions

Port A						Port B				
Design Element	Data Cells(a)	Parity Cells(a)	Address Bus	Data Bus	Parity Bus	Data Cells(a)	Parity Cells(a)	Address Bus	Data Bus	Parity Bus
RAMB16_S2_S36	8192 x 2	-	(12:0)	(1:0)	-	512 x 32	512 x 4	(8:0)	(31:0)	(3:0)
(a)Depth x Width										

Each port is fully synchronous with independent clock pins. All Port A input pins have setup time referenced to the CLKA pin and its data output bus DOA has a clock-to-out time referenced to the CLKA. All Port B input pins have setup time referenced to the CLKB pin and its data output bus DOB has a clock-to-out time referenced to the CLKB. The enable ENA pin controls read, write, and reset for Port A. When ENA is Low, no data is written and the outputs (DOA and DOPA) retain the last state. When ENA is High and reset (SSRA) is High, DOA and DOPA are set to SRVAL\_A during the Low-to-High clock (CLKA) transition; if write enable (WEA) is High, the memory contents reflect the data at DIA and DIPA. When ENA is High and WEA is Low, the data stored in the RAM address (ADDRA) is read during the Low-to-High clock transition. By default, WRITE\_MODE\_A=WRITE\_FIRST, when ENA and WEA are High, the data on the data inputs (DIA and DIPA) is loaded into the word selected by the write address (ADDRA) during the Low-to-High clock transition and the data outputs (DOA and DOPA) reflect the selected (addressed) word.

The enable ENB pin controls read, write, and reset for Port B. When ENB is Low, no data is written and the outputs (DOB and DOPB) retain the last state. When ENB is High and reset (SSRB) is High, DOB and DOPB are set to SRVAL\_B during the Low-to-High clock (CLKB) transition; if write enable (WEB) is High, the memory contents reflect the data at DIB and DIPB. When ENB is High and WEB is Low, the data stored in the RAM address (ADDRB) is read during the Low-to-High clock transition. By default, WRITE\_MODE\_B=WRITE\_FIRST, when ENB and WEB are High, the data on the data inputs (DIB and DIPB) are loaded into the word selected by the write address (ADDRB) during the Low-to-High clock transition and the data outputs (DOB and DOPB) reflect the selected (addressed) word. The above descriptions assume active High control pins (ENA, WEA, SSRA, CLKA, ENB, WEB, SSRB, and CLKB). However, the active level can be changed by placing an inverter on the port. Any inverter placed on a RAMB16 port is absorbed into the block and does not use a CLB resource.

### Address Mapping

Each port accesses the same set of 18432 memory cells using an addressing scheme that is dependent on the width of the port. For all port widths, 16384 memory cells are available for data as shown in the "Port Address Mapping for Data" table below. For 9-, 18-, and 36-bit wide ports, 2408 parity memory cells are also available as shown in "Port Address Mapping for Parity" table below. The physical RAM location that is addressed for a particular width is determined from the following formula.

$$\text{Start} = ((\text{ADDR}_{\text{port}} + 1) * (\text{Width}_{\text{port}})) - 1$$

$$\text{End} = (\text{ADDR}_{\text{port}}) * (\text{Width}_{\text{port}})$$

The following tables shows address mapping for each port width.

### Port Address Mapping for Data

Data Width	Port Data Addresses	31	30	29	28	27	26	25	24	23	22	21	20	19	18	17	16	15	14	13	12	11	10	9	8	7	6	5	4	3	2	1	0
1	16384	<--																															
2	8192	<--	15		14					11		10		9		8		7		6		5		4		3		2		1		0	
4	4096	<--	7			6				5				4				3				2				1				0			
8	2048	<--	3							2								1								0							
16	1024	<--	1															0															
32	512	<--	0																														

### Port Address Mapping for Parity

Parity Width	Port Parity Addresses																
1	2048	<-----	3					2					1				0
2	1024	<-----	1										0				
4	512	<-----	0														

#### Initializing Memory Contents of a Dual-Port RAMB16

You can use the INIT\_xx attributes to specify an initialization value for the memory contents of a RAMB16 during device configuration. The initialization of each RAMB16\_Sm\_Sn is set by 64 initialization attributes (INIT\_00 through INIT\_3F) of 64 hex values for a total of 16384 bits.

You can use the INITP\_xx attributes to specify an initial value for the parity memory during device configuration or assertion. The initialization of the parity memory for ports configured for 9, 18, or 36 bits is set by 8 initialization attributes (INITP\_00 through INITP\_07) of 64 hex values for a total of 2048 bits.

If any INIT\_xx or INITP\_xx attribute is not specified, it is configured as zeros. Partial Strings are padded with zeros to the left.

#### Initializing the Output Register of a Dual-Port RAMB16

In Spartan-3A, each bit in an output register can be initialized at power on (when GSR is high) to either a 0 or 1. In addition, the initial state specified for power on can be different than the state that results from assertion of a set/reset. Four properties control initialization of the output register for a dual-port RAMB16: INIT\_A, INIT\_B, SRVAL\_A, and SRVAL\_B. The INIT\_A attribute specifies the output register value at power on for Port A and the INIT\_B attribute specifies the value for Port B. You can use the SRVAL\_A attribute to define the state resulting from assertion of the SSR (set/reset) input on Port A. You can use the SRVAL\_B attribute to define the state resulting from assertion of the SSR input on Port B.

The INIT\_A, INIT\_B, SRVAL\_A, and SRVAL\_B attributes specify the initialization value as a hexadecimal String. The value is dependent upon the port width. For example, for a RAMB16\_S1\_S4 with Port A width equal to 1 and Port B width equal to 4, the Port A output register contains 1 bit and the Port B output register contains 4 bits. Therefore, the INIT\_A or SRVAL\_A value can only be specified as a 1 or 0. For Port B, the output register contains 4 bits. In this case, you can use INIT\_B or SRVAL\_B to specify a hexadecimal value from 0 through F to initialize the 4 bits of the output register.

For those ports that include parity bits, the parity portion of the output register is specified in the high order bit position of the INIT\_A, INIT\_B, SRVAL\_A, or SRVAL\_B value.

The INIT and SRVAL attributes default to zero if they are not set by you.

#### Write Mode Selection

The WRITE\_MODE\_A attribute controls the memory and output contents of Port A for a dual-port RAMB16. The WRITE\_MODE\_B attribute does the same for Port B. By default, both WRITE\_MODE\_A and WRITE\_MODE\_B are set to WRITE\_FIRST. This means that input is read, written to memory, and then passed to output. You can set the write mode for Port A and Port B to READ\_FIRST to read the memory contents, pass the memory contents to the outputs, and then write the input to memory. Or, you can set the write mode to NO\_CHANGE to have the input written to memory without changing the output. The "Port A and Port B Conflict Resolution" section describes how read/write conflicts are resolved when both Port A and Port B are attempting to read/write to the same memory cells.

#### Port A and Port B Conflict Resolution

Spartan-3A block SelectRAM is True Dual-Port RAM that allows both ports to simultaneously access the same memory cell. When one port writes to a given memory cell, the other port must not address that memory cell (for a write or a read) within the clock-to-clock setup window.

The following tables summarize the collision detection behavior of the dual-port RAMB16 based on the WRITE\_MODE\_A and WRITE\_MODE\_B settings.

*WRITE\_MODE\_A=NO\_CHANGE and WRITE\_MODE\_B=NO\_CHANGE*

WEA	WEB	CLKA	CLKB	DIA	DIB	DIPA	DIPB	DOA	DOB	DOPA	DOPB	Data RAM	Parity Ram
0	0	↑	↑	DIA	DIB	DIPA	DIPB	RAM	RAM	RAM	RAM	No Change	No Change
1	0	↑	↑	DIA	DIB	DIPA	DIPB	No Change	X	No Change	X	DIA	DIPA
0	1	↑	↑	DIA	DIB	DIPA	DIPB	X	No Change	X	No Change	DIB	DIPB
1	1	↑	↑	DIA	DIB	DIPA	DIPB	No Change	No Change	No Change	No Change	X	X

*WRITE\_MODE\_A=READ\_FIRST and WRITE\_MODE\_B=READ\_FIRST*

WEA	WEB	CLKA	CLKB	DIA	DIB	DIPA	DIPB	DOA	DOB	DOPA	DOPB	Data RAM	Parity Ram
0	0	↑	↑	DIA	DIB	DIPA	DIPB	RAM	RAM	RAM	RAM	No Change	No Change
1	0	↑	↑	DIA	DIB	DIPA	DIPB	RAM	RAM	RAM	RAM	DIA	DIPA
0	1	↑	↑	DIA	DIB	DIPA	DIPB	RAM	RAM	RAM	RAM	DIB	DIPB
1	1	↑	↑	DIA	DIB	DIPA	DIPB	RAM	RAM	RAM	RAM	X	X

*WRITE\_MODE\_A= WRITE\_FIRST and WRITE\_MODE\_B=WRITE\_FIRST*

WEA	WEB	CLKA	CLKB	DIA	DIB	DIPA	DIPB	DOA	DOB	DOPA	DOPB	Data RAM	Parity Ram
0	0	↑	↑	DIA	DIB	DIPA	DIPB	RAM	RAM	RAM	RAM	No Change	No Change
1	0	↑	↑	DIA	DIB	DIPA	DIPB	DIA	X	DIPA	X	DIA	DIPA
0	1	↑	↑	DIA	DIB	DIPA	DIPB	X	DIB	X	DIPB	DIB	DIPB
1	1	↑	↑	DIA	DIB	DIPA	DIPB	X	X	X	X	X	X

*WRITE\_MODE\_A=NO\_CHANGE and WRITE\_MODE\_B=READ\_FIRST*

WEA	WEB	CLKA	CLKB	DIA	DIB	DIPA	DIPB	DOA	DOB	DOPA	DOPB	Data RAM	Parity Ram
0	0	↑	↑	DIA	DIB	DIPA	DIPB	RAM	RAM	RAM	RAM	No Change	No Change
1	0	↑	↑	DIA	DIB	DIPA	DIPB	No Change	X	No Change	X	DIA	DIPA
0	1	↑	↑	DIA	DIB	DIPA	DIPB	RAM	RAM	RAM	RAM	DIB	DIPB
1	1	↑	↑	DIA	DIB	DIPA	DIPB	No Change	X	No Change	X	DIB	DIPB

*WRITE\_MODE\_A=NO\_CHANGE and WRITE\_MODE\_B=WRITE\_FIRST*

WEA	WEB	CLKA	CLKB	DIA	DIB	DIPA	DIPB	DOA	DOB	DOPA	DOPB	Data RAM	Parity Ram
0	0	↑	↑	DIA	DIB	DIPA	DIPB	RAM	RAM	RAM	RAM	No Change	No Change
1	0	↑	↑	DIA	DIB	DIPA	DIPB	No Change	X	No Change	X	DIA	DIPA

WEA	WEB	CLKA	CLKB	DIA	DIB	DIPA	DIPB	DOA	DOB	DOPA	DOPB	Data RAM	Parity Ram
0	1	↑	↑	DIA	DIB	DIPA	DIPB	X	DIB	X	DIPB	DIB	DIPB
1	1	↑	↑	DIA	DIB	DIPA	DIPB	No Change	X	No Change	X	X	X

*WRITE\_MODE\_A=READ\_FIRST and WRITE\_MODE\_B=WRITE\_FIRST*

WEA	WEB	CLKA	CLKB	DIA	DIB	DIPA	DIPB	DOA	DOB	DOPA	DOPB	Data RAM	Parity Ram
0	0	↑	↑	DIA	DIB	DIPA	DIPB	RAM	RAM	RAM	RAM	No Change	No Change
1	0	↑	↑	DIA	DIB	DIPA	DIPB	RAM	RAM	RAM	RAM	DIA	DIPA
0	1	↑	↑	DIA	DIB	DIPA	DIPB	X	DIB	X	DIPB	DIB	DIPB
1	1	↑	↑	DIA	DIB	DIPA	DIPB	X	DIB	X	DIPB	DIA	DIPA

## Design Entry Method

This design element can be used in schematics.

## Available Attributes

Attribute	Type	Allowed Values	Default	Description
INIT_00 To INIT_3F	Binary/Hexadecimal	Any	All zeros	Specifies the initial contents of the data portion of the RAM array.
INIT_A	Binary/Hexadecimal	Any	All zeros	Identifies the initial value of the DOA/DOB output port after completing configuration. For Type, the bit width is dependent on the width of the A or B port of the RAM.
INIT_B	Binary/Hexadecimal	Any	All zeros	Identifies the initial value of the DOA/DOB output port after completing configuration. For Type, the bit width is dependent on the width of the A or B port of the RAM.
INITP_00 To INITP_07	Binary/Hexadecimal	Any	All zeros	Specifies the initial contents of the parity portion of the RAM array.
SIM_COLLISION_CHECK	String	"ALL", "NONE", "WARNING", or "GENERATE_X_ONLY"	"ALL"	Specifies the behavior during simulation in the event of a data collision (data being read or written to the same address from both ports of the Ram simultaneously. "ALL" issues a warning to simulator console and generate an X or all unknown data due to the collision. This is the recommended setting. "WARNING" generates a warning only and "GENERATE_X_ONLY" generates an X for unknown data but won't output the occurrence to the simulation console. "NONE" completely ignores the error. It is suggested to only change this attribute if you can ensure the data generated during a collision is discarded.

Attribute	Type	Allowed Values	Default	Description
SRVAL_A	Binary/Hexadecimal	Any	All zeros	Allows the individual selection of whether the DOA/DOB output port sets (go to a one) or reset (go to a zero) upon the assertion of the RSTA pin. For Type, the bit width is dependent on the width of the A port of the RAM.
SRVAL_B	Binary/Hexadecimal	Any	All zeros	Allows the individual selection of whether the DOA/DOB output port sets (go to a one) or reset (go to a zero) upon the assertion of the RSTB pin. For Type, the bit width is dependent on the width of the B port of the RAM.
WRITE_MODE_A	String	"WRITE_FIRST", "READ_FIRST" or "NO_CHANGE"	"WRITE_FIRST"	Specifies the behavior of the DOA/DOB port upon a write command to the respected port. If set to WRITE_FIRST, the same port that is written to displays the contents of the written data to the outputs upon completion of the operation. "READ_FIRST" displays the prior contents of the RAM to the output port prior to writing the new data. "NO_CHANGE" keeps the previous value on the output port and won't update the output port upon a write command. This is the suggested mode if not using the read data from a particular port of the RAM
WRITE_MODE_B	String	"WRITE_FIRST", "READ_FIRST" or "NO_CHANGE"	"WRITE_FIRST"	Specifies the behavior of the DOA/DOB port upon a write command to the respected port. If set to WRITE_FIRST, the same port that is written to displays the contents of the written data to the outputs upon completion of the operation. "READ_FIRST" displays the prior contents of the RAM to the output port prior to writing the new data. "NO_CHANGE" keeps the previous value on the output port and won't update the output port upon a write command. This is the suggested mode if not using the read data from a particular port of the RAM.

## For More Information

- See the [Spartan-3 User Guide](#).
- See the [Spartan-3 Data Sheets](#).

## RAMB16\_S2\_S4

Primitive: 16K-bit Data and 2K-bit Parity Dual-Port Synchronous Block RAM with 2-bit and 4-bit Ports

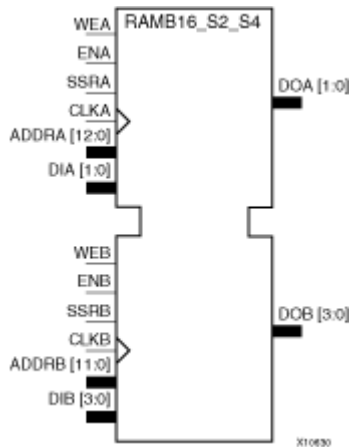

### Introduction

This design element is a dual-ported dedicated random access memory block with synchronous write capability. Each block RAM port has 16384 bits of data memory. Ports configured as 9, 18, or 36-bits wide have an additional 2048 bits of parity memory. Each port is independent of the other while accessing the same set of 16384 data memory cells. Each port is independently configured to a specific data width. The possible port and cell configurations for this element are listed under "Port Descriptions."

### Logic Table

Truth Table A

Inputs								Outputs			
GSR	ENA	SSRA	WEA	CLKA	ADDR_A	DIA	DIPA	DOA	DOPA	RAM Contents	
										Data RAM	Parity RAM
1	X	X	X	X	X	X	X	INIT_A	INIT_A	No Change	No Change
0	0	X	X	X	X	X	X	No Change	No Change	No Change	No Change
0	1	1	0	↑	X	X	X	SRVAL_A	SRVAL_A	No Change	No Change
0	1	1	1	↑	addr	data	pdata	SRVAL_A	SRVAL_A	RAM(addr) =>data	RAM(addr) =>pdata
0	1	0	0	↑	addr	X	X	RAM(addr)	RAM(addr)	No Change	No Change

Inputs								Outputs			
GSR	ENA	SSRA	WEA	CLKA	ADDRA	DIA	DIPA	DOA	DOPA	RAM Contents	
										Data RAM	Parity RAM
0	1	0	1	↑	addr	data	pdata	No Change1, RAM (addr)2, data3	No Change1, RAM (addr)2, pdata3	RAM(addr) =>data	RAM(addr) =>pdata

GSR=Global Set Reset  
 INIT\_A=Value specified by the INIT\_A attribute for output register. Default is all zeros.  
 SRVAL\_A=register value.  
 addr=RAM address.  
 RAM(addr)=RAM contents at address ADDR.  
 data=RAM input data.  
 pdata=RAM parity data.  
 1WRITE\_MODE\_A=NO\_CHANGE.  
 2WRITE\_MODE\_A=READ\_FIRST.  
 3WRITE\_MODE\_A=WRITE\_FIRST.

Truth Table B

Inputs								Outputs			
GSR	ENB	SSRB	WEB	CLKB	ADDRB	DIB	DIPB	DOB	DOPB	RAM Contents	
										Data RAM	Parity RAM
1	X	X	X	X	X	X	X	INIT_B	INIT_B	No Change	No Change
0	0	X	X	X	X	X	X	No Change	No Change	No Change	No Change
0	1	1	0	↑	X	X	X	SRVAL_B	SRVAL_B	No Change	No Change
0	1	1	1	↑	addr	data	pdata	SRVAL_B	SRVAL_B	RAM(addr) =>data	RAM(addr) =>pdata
0	1	0	0	↑	addr	X	X	RAM(addr)	RAM(addr)	No Change	No Change
0	1	0	1	↑	addr	data	pdata	No Change1, RAM (addr)2, data3	No Change1, RAM (addr)2, pdata3	RAM(addr)2	RAM(addr) =>pdata

GSR=Global Set Reset.  
 INIT\_B=Value specified by the INIT\_B attribute for output registers. Default is all zeros.  
 SRVAL\_B=register value.  
 addr=RAM address.  
 RAM(addr)=RAM contents at address ADDR.  
 data=RAM input data.  
 pdata=RAM parity data.  
 1WRITE\_MODE\_B=NO\_CHANGE.  
 2WRITE\_MODE\_B=READ\_FIRST.

See the ISE 10.1 User Guide for Schematic Designs

## Port Descriptions

Port A						Port B				
Design Element	Data Cells (a)	Parity Cells (a)	Address Bus	Data Bus	Parity Bus	Data Cells (a)	Parity Cells (a)	Address Bus	Data Bus	Parity Bus
RAMB16_S2_S4	8192 x 2	-	(12:0)	(1:0)	-	4096 x 4	-	(11:0)	(3:0)	-
(a) Depth x Width										

Each port is fully synchronous with independent clock pins. All Port A input pins have setup time referenced to the CLKA pin and its data output bus DOA has a clock-to-out time referenced to the CLKA. All Port B input pins have setup time referenced to the CLKB pin and its data output bus DOB has a clock-to-out time referenced to the CLKB. The enable ENA pin controls read, write, and reset for Port A. When ENA is Low, no data is written and the outputs (DOA and DOPA) retain the last state. When ENA is High and reset (SSRA) is High, DOA and DOPA are set to SRVAL\_A during the Low-to-High clock (CLKA) transition; if write enable (WEA) is High, the memory contents reflect the data at DIA and DIPA. When ENA is High and WEA is Low, the data stored in the RAM address (ADDRA) is read during the Low-to-High clock transition. By default, WRITE\_MODE\_A=WRITE\_FIRST, when ENA and WEA are High, the data on the data inputs (DIA and DIPA) is loaded into the word selected by the write address (ADDRA) during the Low-to-High clock transition and the data outputs (DOA and DOPA) reflect the selected (addressed) word.

The enable ENB pin controls read, write, and reset for Port B. When ENB is Low, no data is written and the outputs (DOB and DOPB) retain the last state. When ENB is High and reset (SSRB) is High, DOB and DOPB are set to SRVAL\_B during the Low-to-High clock (CLKB) transition; if write enable (WEB) is High, the memory contents reflect the data at DIB and DIPB. When ENB is High and WEB is Low, the data stored in the RAM address (ADDRB) is read during the Low-to-High clock transition. By default, WRITE\_MODE\_B=WRITE\_FIRST, when ENB and WEB are High, the data on the data inputs (DIB and DIPB) are loaded into the word selected by the write address (ADDRB) during the Low-to-High clock transition and the data outputs (DOB and DOPB) reflect the selected (addressed) word. The above descriptions assume active High control pins (ENA, WEA, SSRA, CLKA, ENB, WEB, SSRB, and CLKB). However, the active level can be changed by placing an inverter on the port. Any inverter placed on a RAMB16 port is absorbed into the block and does not use a CLB resource.

### Address Mapping

Each port accesses the same set of 18432 memory cells using an addressing scheme that is dependent on the width of the port. For all port widths, 16384 memory cells are available for data as shown in the "Port Address Mapping for Data" table below. For 9-, 18-, and 36-bit wide ports, 2408 parity memory cells are also available as shown in "Port Address Mapping for Parity" table below. The physical RAM location that is addressed for a particular width is determined from the following formula.

$$\text{Start} = ((\text{ADDR}_{\text{port}} + 1) * (\text{Width}_{\text{port}})) - 1$$

$$\text{End} = (\text{ADDR}_{\text{port}}) * (\text{Width}_{\text{port}})$$

The following tables shows address mapping for each port width.

### Port Address Mapping for Data

Data Width	Port Data Addresses																																	
1	16384	<--	31	30	29	28	27	26	25	24	23	22	21	20	19	18	17	16	15	14	13	12	11	10	9	8	7	6	5	4	3	2	1	0
2	8192	<--	15		14		13		12		11		10		9		8		7		6		5		4		3		2		1		0	
4	4096	<--	7				6				5				4				3				2				1				0			
8	2048	<--	3								2								1								0							
16	1024	<--	1																0															
32	512	<--	0																															

### Port Address Mapping for Parity



Parity Width	Port Parity Addresses																
1	2048	<-----	3					2					1				0
2	1024	<-----	1										0				
4	512	<-----	0														

#### Initializing Memory Contents of a Dual-Port RAMB16

You can use the INIT\_XX attributes to specify an initialization value for the memory contents of a RAMB16 during device configuration. The initialization of each RAMB16\_Sm\_Sn is set by 64 initialization attributes (INIT\_00 through INIT\_3F) of 64 hex values for a total of 16384 bits.

You can use the INITP\_XX attributes to specify an initial value for the parity memory during device configuration or assertion. The initialization of the parity memory for ports configured for 9, 18, or 36 bits is set by 8 initialization attributes (INITP\_00 through INITP\_07) of 64 hex values for a total of 2048 bits.

If any INIT\_XX or INITP\_XX attribute is not specified, it is configured as zeros. Partial strings are padded with zeros to the left.

#### Initializing the Output Register of a Dual-Port RAMB16

In Spartan-3A, each bit in an output register can be initialized at power on (when GSR is high) to either a 0 or 1. In addition, the initial state specified for power on can be different than the state that results from assertion of a set/reset. Four properties control initialization of the output register for a dual-port RAMB16: INIT\_A, INIT\_B, SRVAL\_A, and SRVAL\_B. The INIT\_A attribute specifies the output register value at power on for Port A and the INIT\_B attribute specifies the value for Port B. You can use the SRVAL\_A attribute to define the state resulting from assertion of the SSR (set/reset) input on Port A. You can use the SRVAL\_B attribute to define the state resulting from assertion of the SSR input on Port B.

The INIT\_A, INIT\_B, SRVAL\_A, and SRVAL\_B attributes specify the initialization value as a hexadecimal string. The value is dependent upon the port width. For example, for a RAMB16\_S1\_S4 with Port A width equal to 1 and Port B width equal to 4, the Port A output register contains 1 bit and the Port B output register contains 4 bits. Therefore, the INIT\_A or SRVAL\_A value can only be specified as a 1 or 0. For Port B, the output register contains 4 bits. In this case, you can use INIT\_B or SRVAL\_B to specify a hexadecimal value from 0 through F to initialize the 4 bits of the output register.

For those ports that include parity bits, the parity portion of the output register is specified in the high order bit position of the INIT\_A, INIT\_B, SRVAL\_A, or SRVAL\_B value.

The INIT and SRVAL attributes default to zero if they are not set by you.

#### Write Mode Selection

The WRITE\_MODE\_A attribute controls the memory and output contents of Port A for a dual-port RAMB16. The WRITE\_MODE\_B attribute does the same for Port B. By default, both WRITE\_MODE\_A and WRITE\_MODE\_B are set to WRITE\_FIRST. This means that input is read, written to memory, and then passed to output. You can set the write mode for Port A and Port B to READ\_FIRST to read the memory contents, pass the memory contents to the outputs, and then write the input to memory. Or, you can set the write mode to NO\_CHANGE to have the input written to memory without changing the output. The "Port A and Port B Conflict Resolution" section describes how read/write conflicts are resolved when both Port A and Port B are attempting to read/write to the same memory cells.

#### Port A and Port B Conflict Resolution

Spartan-3A block SelectRAM is True Dual-Port RAM that allows both ports to simultaneously access the same memory cell. When one port writes to a given memory cell, the other port must not address that memory cell (for a write or a read) within the clock-to-clock setup window.

The following tables summarize the collision detection behavior of the dual-port RAMB16 based on the WRITE\_MODE\_A and WRITE\_MODE\_B settings.

WRITE\_MODE\_A=NO\_CHANGE and WRITE\_MODE\_B=NO\_CHANGE

WEA	WEB	CLKA	CLKB	DIA	DIB	DIPA	DIPB	DOA	DOB	DOPA	DOPB	Data RAM	Parity Ram
0	0	↑	↑	DIA	DIB	DIPA	DIPB	RAM	RAM	RAM	RAM	No Change	No Change
1	0	↑	↑	DIA	DIB	DIPA	DIPB	No Change	X	No Change	X	DIA	DIPA
0	1	↑	↑	DIA	DIB	DIPA	DIPB	X	No Change	X	No Change	DIB	DIPB
1	1	↑	↑	DIA	DIB	DIPA	DIPB	No Change	No Change	No Change	No Change	X	X

*WRITE\_MODE\_A=READ\_FIRST and WRITE\_MODE\_B=READ\_FIRST*

WEA	WEB	CLKA	CLKB	DIA	DIB	DIPA	DIPB	DOA	DOB	DOPA	DOPB	Data RAM	Parity Ram
0	0	↑	↑	DIA	DIB	DIPA	DIPB	RAM	RAM	RAM	RAM	No Change	No Change
1	0	↑	↑	DIA	DIB	DIPA	DIPB	RAM	RAM	RAM	RAM	DIA	DIPA
0	1	↑	↑	DIA	DIB	DIPA	DIPB	RAM	RAM	RAM	RAM	DIB	DIPB
1	1	↑	↑	DIA	DIB	DIPA	DIPB	RAM	RAM	RAM	RAM	X	X

*WRITE\_MODE\_A=WRITE\_FIRST and WRITE\_MODE\_B=WRITE\_FIRST*

WEA	WEB	CLKA	CLKB	DIA	DIB	DIPA	DIPB	DOA	DOB	DOPA	DOPB	Data RAM	Parity Ram
0	0	↑	↑	DIA	DIB	DIPA	DIPB	RAM	RAM	RAM	RAM	No Change	No Change
1	0	↑	↑	DIA	DIB	DIPA	DIPB	DIA	X	DIPA	X	DIA	DIPA
0	1	↑	↑	DIA	DIB	DIPA	DIPB	X	DIB	X	DIPB	DIB	DIPB
1	1	↑	↑	DIA	DIB	DIPA	DIPB	X	X	X	X	X	X

*WRITE\_MODE\_A=NO\_CHANGE and WRITE\_MODE\_B=READ\_FIRST*

WEA	WEB	CLKA	CLKB	DIA	DIB	DIPA	DIPB	DOA	DOB	DOPA	DOPB	Data RAM	Parity Ram
0	0	↑	↑	DIA	DIB	DIPA	DIPB	RAM	RAM	RAM	RAM	No Change	No Change
1	0	↑	↑	DIA	DIB	DIPA	DIPB	No Change	X	No Change	X	DIA	DIPA
0	1	↑	↑	DIA	DIB	DIPA	DIPB	RAM	RAM	RAM	RAM	DIB	DIPB
1	1	↑	↑	DIA	DIB	DIPA	DIPB	No Change	X	No Change	X	DIB	DIPB

*WRITE\_MODE\_A=NO\_CHANGE and WRITE\_MODE\_B=WRITE\_FIRST*

WEA	WEB	CLKA	CLKB	DIA	DIB	DIPA	DIPB	DOA	DOB	DOPA	DOPB	Data RAM	Parity Ram
0	0	↑	↑	DIA	DIB	DIPA	DIPB	RAM	RAM	RAM	RAM	No Change	No Change
1	0	↑	↑	DIA	DIB	DIPA	DIPB	No Change	X	No Change	X	DIA	DIPA

WEA	WEB	CLKA	CLKB	DIA	DIB	DIPA	DIPB	DOA	DOB	DOPA	DOPB	Data RAM	Parity Ram
0	1	↑	↑	DIA	DIB	DIPA	DIPB	X	DIB	X	DIPB	DIB	DIPB
1	1	↑	↑	DIA	DIB	DIPA	DIPB	No Change	X	No Change	X	X	X

*WRITE\_MODE\_A=READ\_FIRST and WRITE\_MODE\_B=WRITE\_FIRST*

WEA	WEB	CLKA	CLKB	DIA	DIB	DIPA	DIPB	DOA	DOB	DOPA	DOPB	Data RAM	Parity Ram
0	0	↑	↑	DIA	DIB	DIPA	DIPB	RAM	RAM	RAM	RAM	No Change	No Change
1	0	↑	↑	DIA	DIB	DIPA	DIPB	RAM	RAM	RAM	RAM	DIA	DIPA
0	1	↑	↑	DIA	DIB	DIPA	DIPB	X	DIB	X	DIPB	DIB	DIPB
1	1	↑	↑	DIA	DIB	DIPA	DIPB	X	DIB	X	DIPB	DIA	DIPA

## Design Entry Method

This design element can be used in schematics.

## Available Attributes

Attribute	Type	Allowed Values	Default	Description
INIT_00 To INIT_3F	Binary/Hexadecimal	Any	All zeros	Specifies the initial contents of the data portion of the RAM array.
INIT_A	Binary/Hexadecimal	Any	All zeros	Identifies the initial value of the DOA/DOB output port after completing configuration. For Type, the bit width is dependent on the width of the A or B port of the RAM.
INIT_B	Binary/Hexadecimal	Any	All zeros	Identifies the initial value of the DOA/DOB output port after completing configuration. For Type, the bit width is dependent on the width of the A or B port of the RAM.
INITP_00 To INITP_07	Binary/Hexadecimal	Any	All zeros	Specifies the initial contents of the parity portion of the RAM array.
SIM_COLLISION_CHECK	String	"ALL", "NONE", "WARNING", or "GENERATE_X_ONLY"	"ALL"	Specifies the behavior during simulation in the event of a data collision (data being read or written to the same address from both ports of the Ram simultaneously. "ALL" issues a warning to simulator console and generate an X or all unknown data due to the collision. This is the recommended setting. "WARNING" generates a warning only and "GENERATE_X_ONLY" generates an X for unknown data but won't output the occurrence to the simulation console. "NONE" completely ignores the error. It is suggested to only change this attribute if you can ensure the data generated during a collision is discarded.
SRVAL_A	Binary/Hexadecimal	Any	All zeros	Allows the individual selection of whether the DOA/DOB output port sets (go to a one) or reset (go to a zero) upon the assertion of the RSTA pin. For Type, the bit width is dependent on the width of the A port of the RAM.

Attribute	Type	Allowed Values	Default	Description
SRVAL_B	Binary/Hexadecimal	Any	All zeros	Allows the individual selection of whether the DOA/DOB output port sets (go to a one) or reset (go to a zero) upon the assertion of the RSTB pin. For Type, the bit width is dependent on the width of the B port of the RAM.
WRITE_MODE_A	String	"WRITE_FIRST", "READ_FIRST" or "NO_CHANGE"	"WRITE_FIRST"	Specifies the behavior of the DOA/DOB port upon a write command to the respected port. If set to WRITE_FIRST, the same port that is written to displays the contents of the written data to the outputs upon completion of the operation. READ_FIRST displays the prior contents of the RAM to the output port prior to writing the new data. NO_CHANGE keeps the previous value on the output port and won't update the output port upon a write command. This is the suggested mode if not using the read data from a particular port of the RAM
WRITE_MODE_B	String	"WRITE_FIRST", "READ_FIRST" or "NO_CHANGE"	"WRITE_FIRST"	Specifies the behavior of the DOA/DOB port upon a write command to the respected port. If set to WRITE_FIRST, the same port that is written to displays the contents of the written data to the outputs upon completion of the operation. READ_FIRST displays the prior contents of the RAM to the output port prior to writing the new data. NO_CHANGE keeps the previous value on the output port and won't update the output port upon a write command. This is the suggested mode if not using the read data from a particular port of the RAM.

## For More Information

- See the [Spartan-3 User Guide](#).
- See the [Spartan-3 Data Sheets](#).

# RAMB16\_S2\_S9

Primitive: 16K-bit Data and 2K-bit Parity Dual-Port Synchronous Block RAM with 2-bit and 9-bit Ports

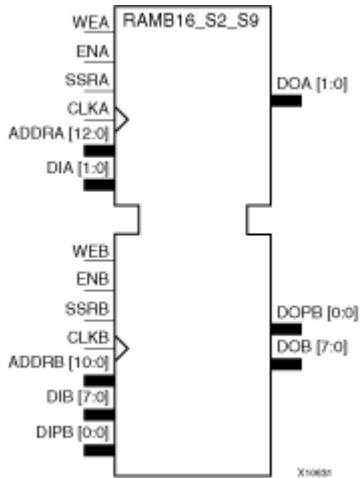

## Introduction

This design element is a dual-ported dedicated random access memory block with synchronous write capability. Each block RAM port has 16384 bits of data memory. Ports configured as 9, 18, or 36-bits wide have an additional 2048 bits of parity memory. Each port is independent of the other while accessing the same set of 16384 data memory cells. Each port is independently configured to a specific data width. The possible port and cell configurations for this element are listed under "Port Descriptions."

## Logic Table

Truth Table A

Inputs								Outputs			
GSR	ENA	SSRA	WEA	CLKA	ADDR_A	DIA	DIPA	DOA	DOPA	RAM Contents	
										Data RAM	Parity RAM
1	X	X	X	X	X	X	X	INIT_A	INIT_A	No Change	No Change
0	0	X	X	X	X	X	X	No Change	No Change	No Change	No Change
0	1	1	0	↑	X	X	X	SRVAL_A	SRVAL_A	No Change	No Change
0	1	1	1	↑	addr	data	pdata	SRVAL_A	SRVAL_A	RAM(addr) =>data	RAM(addr) =>pdata
0	1	0	0	↑	addr	X	X	RAM(addr)	RAM(addr)	No Change	No Change

Inputs								Outputs			
GSR	ENA	SSRA	WEA	CLKA	ADDRA	DIA	DIPA	DOA	DOPA	RAM Contents	
										Data RAM	Parity RAM
0	1	0	1	↑	addr	data	pdata	No Change1, RAM (addr)2, data3	No Change1, RAM (addr)2, pdata3	RAM(addr) =>data	RAM(addr) =>pdata

GSR=Global Set Reset  
 INIT\_A=Value specified by the INIT\_A attribute for output register. Default is all zeros.  
 SRVAL\_A=register value.  
 addr=RAM address.  
 RAM(addr)=RAM contents at address ADDR.  
 data=RAM input data.  
 pdata=RAM parity data.  
 1WRITE\_MODE\_A=NO\_CHANGE.  
 2WRITE\_MODE\_A=READ\_FIRST.  
 3WRITE\_MODE\_A=WRITE\_FIRST.

Truth Table B

Inputs								Outputs			
GSR	ENB	SSRB	WEB	CLKB	ADDRB	DIB	DIPB	DOB	DOPB	RAM Contents	
										Data RAM	Parity RAM
1	X	X	X	X	X	X	X	INIT_B	INIT_B	No Change	No Change
0	0	X	X	X	X	X	X	No Change	No Change	No Change	No Change
0	1	1	0	↑	X	X	X	SRVAL_B	SRVAL_B	No Change	No Change
0	1	1	1	↑	addr	data	pdata	SRVAL_B	SRVAL_B	RAM(addr) =>data	RAM(addr) =>pdata
0	1	0	0	↑	addr	X	X	RAM(addr)	RAM(addr)	No Change	No Change
0	1	0	1	↑	addr	data	pdata	No Change1, RAM (addr)2, data3	No Change1, RAM (addr)2, pdata3	RAM(addr)2	RAM(addr) =>pdata

GSR=Global Set Reset.  
 INIT\_B=Value specified by the INIT\_B attribute for output registers. Default is all zeros.  
 SRVAL\_B=register value.  
 addr=RAM address.  
 RAM(addr)=RAM contents at address ADDR.  
 data=RAM input data.  
 pdata=RAM parity data.  
 1WRITE\_MODE\_B=NO\_CHANGE.  
 2WRITE\_MODE\_B=READ\_FIRST.  
 3WRITE\_MODE\_B=WRITE\_FIRST.

## Port Descriptions

Port A						Port B				
Design Element	Data Cells(a)	Parity Cells(a)	Address Bus	Data Bus	Parity Bus	Data Cells(a)	Parity Cells(a)	Address Bus	Data Bus	Parity Bus
RAMB16_S2_S9	8192 x 2	-	(12:0)	(1:0)	-	2048 x 8	2048 x 1	(10:0)	(7:0)	(0:0)
(a)Depth x Width										

Each port is fully synchronous with independent clock pins. All Port A input pins have setup time referenced to the CLKA pin and its data output bus DOA has a clock-to-out time referenced to the CLKA. All Port B input pins have setup time referenced to the CLKB pin and its data output bus DOB has a clock-to-out time referenced to the CLKB. The enable ENA pin controls read, write, and reset for Port A. When ENA is Low, no data is written and the outputs (DOA and DOPA) retain the last state. When ENA is High and reset (SSRA) is High, DOA and DOPA are set to SRVAL\_A during the Low-to-High clock (CLKA) transition; if write enable (WEA) is High, the memory contents reflect the data at DIA and DIPA. When ENA is High and WEA is Low, the data stored in the RAM address (ADDRA) is read during the Low-to-High clock transition. By default, WRITE\_MODE\_A=WRITE\_FIRST, when ENA and WEA are High, the data on the data inputs (DIA and DIPA) is loaded into the word selected by the write address (ADDRA) during the Low-to-High clock transition and the data outputs (DOA and DOPA) reflect the selected (addressed) word.

The enable ENB pin controls read, write, and reset for Port B. When ENB is Low, no data is written and the outputs (DOB and DOPB) retain the last state. When ENB is High and reset (SSRB) is High, DOB and DOPB are set to SRVAL\_B during the Low-to-High clock (CLKB) transition; if write enable (WEB) is High, the memory contents reflect the data at DIB and DIPB. When ENB is High and WEB is Low, the data stored in the RAM address (ADDRB) is read during the Low-to-High clock transition. By default, WRITE\_MODE\_B=WRITE\_FIRST, when ENB and WEB are High, the data on the data inputs (DIB and DIPB) are loaded into the word selected by the write address (ADDRB) during the Low-to-High clock transition and the data outputs (DOB and DOPB) reflect the selected (addressed) word. The above descriptions assume active High control pins (ENA, WEA, SSRA, CLKA, ENB, WEB, SSRB, and CLKB). However, the active level can be changed by placing an inverter on the port. Any inverter placed on a RAMB16 port is absorbed into the block and does not use a CLB resource.

### Address Mapping

Each port accesses the same set of 18432 memory cells using an addressing scheme that is dependent on the width of the port. For all port widths, 16384 memory cells are available for data as shown in the "Port Address Mapping for Data" table below. For 9-, 18-, and 36-bit wide ports, 2408 parity memory cells are also available as shown in "Port Address Mapping for Parity" table below. The physical RAM location that is addressed for a particular width is determined from the following formula.

$$\text{Start} = ((\text{ADDR}_{\text{port}} + 1) * (\text{Width}_{\text{port}})) - 1$$

$$\text{End} = (\text{ADDR}_{\text{port}}) * (\text{Width}_{\text{port}})$$

The following tables shows address mapping for each port width.

### Port Address Mapping for Data

Data Width	Port Data Addresses	31	30	29	28	27	26	25	24	23	22	21	20	19	18	17	16	15	14	13	12	11	10	9	8	7	6	5	4	3	2	1	0
1	16384	<--																															
2	8192	<--	15		14					11		10		9		8		7		6		5		4		3		2		1		0	
4	4096	<--	7			6				5				4				3				2				1				0			
8	2048	<--	3							2								1								0							
16	1024	<--	1															0															
32	512	<--	0																														

### Port Address Mapping for Parity

Parity Width	Port Parity Addresses																
1	2048	<-----	3					2					1				0
2	1024	<-----	1										0				
4	512	<-----	0														

#### Initializing Memory Contents of a Dual-Port RAMB16

You can use the INIT\_xx attributes to specify an initialization value for the memory contents of a RAMB16 during device configuration. The initialization of each RAMB16\_Sm\_Sn is set by 64 initialization attributes (INIT\_00 through INIT\_3F) of 64 hex values for a total of 16384 bits.

You can use the INITP\_xx attributes to specify an initial value for the parity memory during device configuration or assertion. The initialization of the parity memory for ports configured for 9, 18, or 36 bits is set by 8 initialization attributes (INITP\_00 through INITP\_07) of 64 hex values for a total of 2048 bits.

If any INIT\_xx or INITP\_xx attribute is not specified, it is configured as zeros. Partial Strings are padded with zeros to the left.

#### Initializing the Output Register of a Dual-Port RAMB16

In Spartan-3A, each bit in an output register can be initialized at power on (when GSR is high) to either a 0 or 1. In addition, the initial state specified for power on can be different than the state that results from assertion of a set/reset. Four properties control initialization of the output register for a dual-port RAMB16: INIT\_A, INIT\_B, SRVAL\_A, and SRVAL\_B. The INIT\_A attribute specifies the output register value at power on for Port A and the INIT\_B attribute specifies the value for Port B. You can use the SRVAL\_A attribute to define the state resulting from assertion of the SSR (set/reset) input on Port A. You can use the SRVAL\_B attribute to define the state resulting from assertion of the SSR input on Port B.

The INIT\_A, INIT\_B, SRVAL\_A, and SRVAL\_B attributes specify the initialization value as a hexadecimal String. The value is dependent upon the port width. For example, for a RAMB16\_S1\_S4 with Port A width equal to 1 and Port B width equal to 4, the Port A output register contains 1 bit and the Port B output register contains 4 bits. Therefore, the INIT\_A or SRVAL\_A value can only be specified as a 1 or 0. For Port B, the output register contains 4 bits. In this case, you can use INIT\_B or SRVAL\_B to specify a hexadecimal value from 0 through F to initialize the 4 bits of the output register.

For those ports that include parity bits, the parity portion of the output register is specified in the high order bit position of the INIT\_A, INIT\_B, SRVAL\_A, or SRVAL\_B value.

The INIT and SRVAL attributes default to zero if they are not set by you.

#### Write Mode Selection

The WRITE\_MODE\_A attribute controls the memory and output contents of Port A for a dual-port RAMB16. The WRITE\_MODE\_B attribute does the same for Port B. By default, both WRITE\_MODE\_A and WRITE\_MODE\_B are set to WRITE\_FIRST. This means that input is read, written to memory, and then passed to output. You can set the write mode for Port A and Port B to READ\_FIRST to read the memory contents, pass the memory contents to the outputs, and then write the input to memory. Or, you can set the write mode to NO\_CHANGE to have the input written to memory without changing the output. The "Port A and Port B Conflict Resolution" section describes how read/write conflicts are resolved when both Port A and Port B are attempting to read/write to the same memory cells.

#### Port A and Port B Conflict Resolution

Spartan-3A block SelectRAM is True Dual-Port RAM that allows both ports to simultaneously access the same memory cell. When one port writes to a given memory cell, the other port must not address that memory cell (for a write or a read) within the clock-to-clock setup window.

The following tables summarize the collision detection behavior of the dual-port RAMB16 based on the WRITE\_MODE\_A and WRITE\_MODE\_B settings.

*WRITE\_MODE\_A=NO\_CHANGE and WRITE\_MODE\_B=NO\_CHANGE*



WEA	WEB	CLKA	CLKB	DIA	DIB	DIPA	DIPB	DOA	DOB	DOPA	DOPB	Data RAM	Parity Ram
0	0	↑	↑	DIA	DIB	DIPA	DIPB	RAM	RAM	RAM	RAM	No Change	No Change
1	0	↑	↑	DIA	DIB	DIPA	DIPB	No Change	X	No Change	X	DIA	DIPA
0	1	↑	↑	DIA	DIB	DIPA	DIPB	X	No Change	X	No Change	DIB	DIPB
1	1	↑	↑	DIA	DIB	DIPA	DIPB	No Change	No Change	No Change	No Change	X	X

*WRITE\_MODE\_A=READ\_FIRST and WRITE\_MODE\_B=READ\_FIRST*

WEA	WEB	CLKA	CLKB	DIA	DIB	DIPA	DIPB	DOA	DOB	DOPA	DOPB	Data RAM	Parity Ram
0	0	↑	↑	DIA	DIB	DIPA	DIPB	RAM	RAM	RAM	RAM	No Change	No Change
1	0	↑	↑	DIA	DIB	DIPA	DIPB	RAM	RAM	RAM	RAM	DIA	DIPA
0	1	↑	↑	DIA	DIB	DIPA	DIPB	RAM	RAM	RAM	RAM	DIB	DIPB
1	1	↑	↑	DIA	DIB	DIPA	DIPB	RAM	RAM	RAM	RAM	X	X

*WRITE\_MODE\_A= WRITE\_FIRST and WRITE\_MODE\_B=WRITE\_FIRST*

WEA	WEB	CLKA	CLKB	DIA	DIB	DIPA	DIPB	DOA	DOB	DOPA	DOPB	Data RAM	Parity Ram
0	0	↑	↑	DIA	DIB	DIPA	DIPB	RAM	RAM	RAM	RAM	No Change	No Change
1	0	↑	↑	DIA	DIB	DIPA	DIPB	DIA	X	DIPA	X	DIA	DIPA
0	1	↑	↑	DIA	DIB	DIPA	DIPB	X	DIB	X	DIPB	DIB	DIPB
1	1	↑	↑	DIA	DIB	DIPA	DIPB	X	X	X	X	X	X

*WRITE\_MODE\_A=NO\_CHANGE and WRITE\_MODE\_B=READ\_FIRST*

WEA	WEB	CLKA	CLKB	DIA	DIB	DIPA	DIPB	DOA	DOB	DOPA	DOPB	Data RAM	Parity Ram
0	0	↑	↑	DIA	DIB	DIPA	DIPB	RAM	RAM	RAM	RAM	No Change	No Change
1	0	↑	↑	DIA	DIB	DIPA	DIPB	No Change	X	No Change	X	DIA	DIPA
0	1	↑	↑	DIA	DIB	DIPA	DIPB	RAM	RAM	RAM	RAM	DIB	DIPB
1	1	↑	↑	DIA	DIB	DIPA	DIPB	No Change	X	No Change	X	DIB	DIPB

*WRITE\_MODE\_A=NO\_CHANGE and WRITE\_MODE\_B=WRITE\_FIRST*

WEA	WEB	CLKA	CLKB	DIA	DIB	DIPA	DIPB	DOA	DOB	DOPA	DOPB	Data RAM	Parity Ram
0	0	↑	↑	DIA	DIB	DIPA	DIPB	RAM	RAM	RAM	RAM	No Change	No Change
1	0	↑	↑	DIA	DIB	DIPA	DIPB	No Change	X	No Change	X	DIA	DIPA

WEA	WEB	CLKA	CLKB	DIA	DIB	DIPA	DIPB	DOA	DOB	DOPA	DOPB	Data RAM	Parity Ram
0	1	↑	↑	DIA	DIB	DIPA	DIPB	X	DIB	X	DIPB	DIB	DIPB
1	1	↑	↑	DIA	DIB	DIPA	DIPB	No Change	X	No Change	X	X	X

WRITE\_MODE\_A=READ\_FIRST and WRITE\_MODE\_B=WRITE\_FIRST

WEA	WEB	CLKA	CLKB	DIA	DIB	DIPA	DIPB	DOA	DOB	DOPA	DOPB	Data RAM	Parity Ram
0	0	↑	↑	DIA	DIB	DIPA	DIPB	RAM	RAM	RAM	RAM	No Change	No Change
1	0	↑	↑	DIA	DIB	DIPA	DIPB	RAM	RAM	RAM	RAM	DIA	DIPA
0	1	↑	↑	DIA	DIB	DIPA	DIPB	X	DIB	X	DIPB	DIB	DIPB
1	1	↑	↑	DIA	DIB	DIPA	DIPB	X	DIB	X	DIPB	DIA	DIPA

## Design Entry Method

This design element can be used in schematics.

## Available Attributes

Attribute	Type	Allowed Values	Default	Description
INIT_00 To INIT_3F	Binary/Hexadecimal	Any	All zeros	Specifies the initial contents of the data portion of the RAM array.
INIT_A	Binary/Hexadecimal	Any	All zeros	Identifies the initial value of the DOA/DOB output port after completing configuration. For Type, the bit width is dependent on the width of the A or B port of the RAM.
INIT_B	Binary/Hexadecimal	Any	All zeros	Identifies the initial value of the DOA/DOB output port after completing configuration. For Type, the bit width is dependent on the width of the A or B port of the RAM.
INITP_00 To INITP_07	Binary/Hexadecimal	Any	All zeros	Specifies the initial contents of the parity portion of the RAM array.
SIM_COLLISION_CHECK	String	"ALL", "NONE", "WARNING", or "GENERATE_X_ONLY"	"ALL"	Specifies the behavior during simulation in the event of a data collision (data being read or written to the same address from both ports of the Ram simultaneously. "ALL" issues a warning to simulator console and generate an X or all unknown data due to the collision. This is the recommended setting. "WARNING" generates a warning only and "GENERATE_X_ONLY" generates an X for unknown data but won't output the occurrence to the simulation console. "NONE" completely ignores the error. It is suggested to only change this attribute if you can ensure the data generated during a collision is discarded.
SRVAL_A	Binary/Hexadecimal	Any	All zeros	Allows the individual selection of whether the DOA/DOB output port sets (go to a one) or reset (go to a zero) upon the assertion of the RSTA pin. For Type, the bit width is dependent on the width of the A port of the RAM.

Attribute	Type	Allowed Values	Default	Description
SRVAL_B	Binary/Hexadecimal	Any	All zeros	Allows the individual selection of whether the DOA/DOB output port sets (go to a one) or reset (go to a zero) upon the assertion of the RSTB pin. For Type, the bit width is dependent on the width of the B port of the RAM.
WRITE_MODE_A	String	"WRITE_FIRST", "READ_FIRST" or "NO_CHANGE"	"WRITE_FIRST"	Specifies the behavior of the DOA/DOB port upon a write command to the respected port. If set to WRITE_FIRST, the same port that is written to displays the contents of the written data to the outputs upon completion of the operation. "READ_FIRST" displays the prior contents of the RAM to the output port prior to writing the new data. "NO_CHANGE" keeps the previous value on the output port and won't update the output port upon a write command. This is the suggested mode if not using the read data from a particular port of the RAM
WRITE_MODE_B	String	"WRITE_FIRST", "READ_FIRST" or "NO_CHANGE"	"WRITE_FIRST"	Specifies the behavior of the DOA/DOB port upon a write command to the respected port. If set to WRITE_FIRST, the same port that is written to displays the contents of the written data to the outputs upon completion of the operation. "READ_FIRST" displays the prior contents of the RAM to the output port prior to writing the new data. "NO_CHANGE" keeps the previous value on the output port and won't update the output port upon a write command. This is the suggested mode if not using the read data from a particular port of the RAM.

## For More Information

- See the [Spartan-3 User Guide](#).
- See the [Spartan-3 Data Sheets](#).

# RAMB16\_S36

Primitive: 16K-bit Data and 2K-bit Parity Single-Port Synchronous Block RAM with 36-bit Port

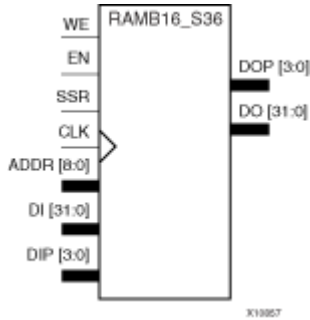

## Introduction

This design element is a dedicated random access memory blocks with synchronous write capability. The block RAM port has 16384 bits of data memory.

The enable ENA pin controls read, write, and reset for Port A. When ENA is Low, no data is written and the outputs (DOA and DOPA) retain the last state. When ENA is High and reset (SSRA) is High, DOA and DOPA are set to SRVAL\_A during the Low-to-High clock (CLKA) transition; if write enable (WEA) is High, the memory contents reflect the data at DIA and DIPA. When ENA is High and WEA is Low, the data stored in the RAM address (ADDRA) is read during the Low-to-High clock transition. By default, WRITE\_MODE\_A=WRITE\_FIRST, when ENA and WEA are High, the data on the data inputs (DIA and DIPA) is loaded into the word selected by the write address (ADDRA) during the Low-to-High clock transition and the data outputs (DOA and DOPA) reflect the selected (addressed) word.

The above description assumes an active High EN, WE, SSR, and CLK. However, the active level can be changed by placing an inverter on the port. Any inverter placed on a RAMB16 port is absorbed into the block and does not use a CLB resource.

The cell configuration for this element is listed in the following table.

	Data Cells		Parity Cells				
Component	Depth	Width	Depth	Width	Address Bus	Data Bus	Parity Bus
RAMB16_S36	512	32	512	4	(8:0)	(31:0)	(3:0)

## Available Attributes

Attribute	Type	Allowed Values	Default	Description
INIT	Binary	Any Hex Value	All zeros	Identifies the initial value of the DO output port after completing configuration. The bit width is dependent on the width of the A or B port of the RAM.
INIT_00 - INIT_3F	Binary	Any Hex Value	All zeros	Specifies the initial contents of the data portion of the RAM array.
INITP_00 - INITP_07	Binary	Any Hex Value	All zeros	Specifies the initial contents of the parity portion of the RAM array.

Attribute	Type	Allowed Values	Default	Description
SRVAL	Binary	Any Hex Value	All zeros	Allows the individual selection of whether the DO output port sets (go to a one) or reset (go to a zero) upon the assertion of the SSR pin. The bit width is dependent on the width of the A or B port of the RAM.
WRITE_MODE	String	"WRITE_FIRST", "READ_FIRST" or "NO_CHANGE"	"WRITE_FIRST"	Specifies the behavior of the DO port upon a write command to the respected port. If set to "WRITE_FIRST", the same port that is written to displays the contents of the written data to the outputs upon completion of the operation. "READ_FIRST" displays the prior contents of the RAM to the output port prior to writing the new data. "NO_CHANGE" keeps the previous value on the output port and won't update the output port upon a write command. This is the suggested mode if not using the read data from a particular port of the RAM.

### For More Information

- See the [Spartan-3 User Guide](#).
- See the [Spartan-3 Data Sheets](#).

# RAMB16\_S36\_S36

Primitive: 16K-bit Data and 2K-bit Parity Dual-Port Synchronous Block RAM with Two 36-bit Ports

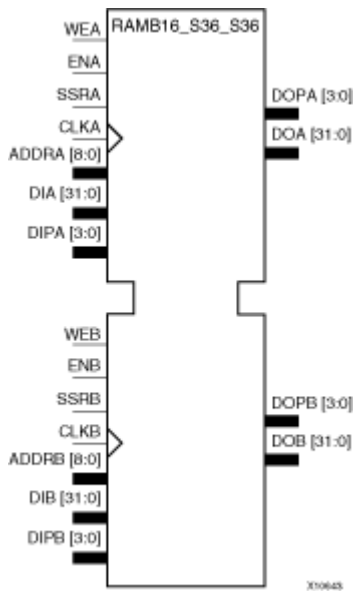

## Introduction

This design element is a dual-ported dedicated random access memory block with synchronous write capability. Each block RAM port has 16384 bits of data memory. Ports configured as 9, 18, or 36-bits wide have an additional 2048 bits of parity memory. Each port is independent of the other while accessing the same set of 16384 data memory cells. Each port is independently configured to a specific data width. The possible port and cell configurations for this element are listed under "Port Descriptions."

## Logic Table

Truth Table A

Inputs								Outputs			
GSR	ENA	SSRA	WEA	CLKA	ADDRa	DIA	DIPA	DOA	DOPA	RAM Contents	
										Data RAM	Parity RAM
1	X	X	X	X	X	X	X	INIT_A	INIT_A	No Change	No Change
0	0	X	X	X	X	X	X	No Change	No Change	No Change	No Change
0	1	1	0	↑	X	X	X	SRVAL_A	SRVAL_A	No Change	No Change
0	1	1	1	↑	addr	data	pdata	SRVAL_A	SRVAL_A	RAM(addr) =>data	RAM(addr) =>pdata
0	1	0	0	↑	addr	X	X	RAM(addr)	RAM(addr)	No Change	No Change

Inputs								Outputs			
GSR	ENA	SSRA	WEA	CLKA	ADDRA	DIA	DIPA	DOA	DOPA	RAM Contents	
										Data RAM	Parity RAM
0	1	0	1	↑	addr	data	pdata	No Change1, RAM (addr)2, data3	No Change1, RAM (addr)2, pdata3	RAM(addr) =>data	RAM(addr) =>pdata

GSR=Global Set Reset  
 INIT\_A=Value specified by the INIT\_A attribute for output register. Default is all zeros.  
 SRVAL\_A=register value.  
 addr=RAM address.  
 RAM(addr)=RAM contents at address ADDR.  
 data=RAM input data.  
 pdata=RAM parity data.  
 1WRITE\_MODE\_A=NO\_CHANGE.  
 2WRITE\_MODE\_A=READ\_FIRST.  
 3WRITE\_MODE\_A=WRITE\_FIRST.

Truth Table B

Inputs								Outputs			
GSR	ENB	SSRB	WEB	CLKB	ADDRB	DIB	DIPB	DOB	DOPB	RAM Contents	
										Data RAM	Parity RAM
1	X	X	X	X	X	X	X	INIT_B	INIT_B	No Change	No Change
0	0	X	X	X	X	X	X	No Change	No Change	No Change	No Change
0	1	1	0	↑	X	X	X	SRVAL_B	SRVAL_B	No Change	No Change
0	1	1	1	↑	addr	data	pdata	SRVAL_B	SRVAL_B	RAM(addr) =>data	RAM(addr) =>pdata
0	1	0	0	↑	addr	X	X	RAM(addr)	RAM(addr)	No Change	No Change
0	1	0	1	↑	addr	data	pdata	No Change1, RAM (addr)2, data3	No Change1, RAM (addr)2, pdata3	RAM(addr)2	RAM(addr) =>pdata

GSR=Global Set Reset.  
 INIT\_B=Value specified by the INIT\_B attribute for output registers. Default is all zeros.  
 SRVAL\_B=register value.  
 addr=RAM address.  
 RAM(addr)=RAM contents at address ADDR.  
 data=RAM input data.  
 pdata=RAM parity data.  
 1WRITE\_MODE\_B=NO\_CHANGE.  
 2WRITE\_MODE\_B=READ\_FIRST.

See the [Xilinx ISE 10.1 User Guide](#) for more information.

## Port Descriptions

Port A						Port B				
Design Element	Data Cells(a)	Parity Cells(a)	Address Bus	Data Bus	Parity Bus	Data Cells(a)	Parity Cells(a)	Address Bus	Data Bus	Parity Bus
RAMB16_S36_S36	512 x 32	512 x 4	(8:0)	(31:0)	(3:0)	512 x 32	512 x 4	(8:0)	(31:0)	(3:0)
(a)Depth x Width										

Each port is fully synchronous with independent clock pins. All Port A input pins have setup time referenced to the CLKA pin and its data output bus DOA has a clock-to-out time referenced to the CLKA. All Port B input pins have setup time referenced to the CLKB pin and its data output bus DOB has a clock-to-out time referenced to the CLKB. The enable ENA pin controls read, write, and reset for Port A. When ENA is Low, no data is written and the outputs (DOA and DOPA) retain the last state. When ENA is High and reset (SSRA) is High, DOA and DOPA are set to SRVAL\_A during the Low-to-High clock (CLKA) transition; if write enable (WEA) is High, the memory contents reflect the data at DIA and DIP A. When ENA is High and WEA is Low, the data stored in the RAM address (ADDR A) is read during the Low-to-High clock transition. By default, WRITE\_MODE\_A=WRITE\_FIRST, when ENA and WEA are High, the data on the data inputs (DIA and DIP A) is loaded into the word selected by the write address (ADDR A) during the Low-to-High clock transition and the data outputs (DOA and DOPA) reflect the selected (addressed) word.

The enable ENB pin controls read, write, and reset for Port B. When ENB is Low, no data is written and the outputs (DOB and DOPB) retain the last state. When ENB is High and reset (SSRB) is High, DOB and DOPB are set to SRVAL\_B during the Low-to-High clock (CLKB) transition; if write enable (WEB) is High, the memory contents reflect the data at DIB and DIPB. When ENB is High and WEB is Low, the data stored in the RAM address (ADDRB) is read during the Low-to-High clock transition. By default, WRITE\_MODE\_B=WRITE\_FIRST, when ENB and WEB are High, the data on the data inputs (DIB and DIPB) are loaded into the word selected by the write address (ADDRB) during the Low-to-High clock transition and the data outputs (DOB and DOPB) reflect the selected (addressed) word. The above descriptions assume active High control pins (ENA, WEA, SSRA, CLKA, ENB, WEB, SSRB, and CLKB). However, the active level can be changed by placing an inverter on the port. Any inverter placed on a RAMB16 port is absorbed into the block and does not use a CLB resource.

### Address Mapping

Each port accesses the same set of 18432 memory cells using an addressing scheme that is dependent on the width of the port. For all port widths, 16384 memory cells are available for data as shown in the "Port Address Mapping for Data" table below. For 9-, 18-, and 36-bit wide ports, 2408 parity memory cells are also available as shown in "Port Address Mapping for Parity" table below. The physical RAM location that is addressed for a particular width is determined from the following formula.

$$\text{Start} = ((\text{ADDR port} + 1) * (\text{Widthport})) - 1$$

$$\text{End} = (\text{ADDRport}) * (\text{Widthport})$$

### Port Address Mapping for Data

Data Width	Port Data Addresses
1	16384 <-- 31 30 29 28 27 26 25 24 23 22 21 20 19 18 17 16 15 14 13 12 11 10 9 8 7 6 5 4 3 2 1 0
2	8192 <-- 15 14 13 12 11 10 9 8 7 6 5 4 3 2 1 0
4	4096 <-- 7 6 5 4 3 2 1 0
8	2048 <-- 3 2 1 0
16	1024 <-- 1 0
32	512 <-- 0

### Port Address Mapping for Parity



Parity Width	Port Parity Addresses																
1	2048	<-----	3					2					1				0
2	1024	<-----	1										0				
4	512	<-----	0														

#### Initializing Memory Contents of a Dual-Port RAMB16

You can use the INIT\_xx attributes to specify an initialization value for the memory contents of a RAMB16 during device configuration. The initialization of each RAMB16\_Sm\_Sn is set by 64 initialization attributes (INIT\_00 through INIT\_3F) of 64 hex values for a total of 16384 bits.

You can use the INITP\_xx attributes to specify an initial value for the parity memory during device configuration or assertion. The initialization of the parity memory for ports configured for 9, 18, or 36 bits is set by 8 initialization attributes (INITP\_00 through INITP\_07) of 64 hex values for a total of 2048 bits.

If any INIT\_xx or INITP\_xx attribute is not specified, it is configured as zeros. Partial Strings are padded with zeros to the left.

#### Initializing the Output Register of a Dual-Port RAMB16

In Spartan-3A, each bit in an output register can be initialized at power on (when GSR is high) to either a 0 or 1. In addition, the initial state specified for power on can be different than the state that results from assertion of a set/reset. Four properties control initialization of the output register for a dual-port RAMB16: INIT\_A, INIT\_B, SRVAL\_A, and SRVAL\_B. The INIT\_A attribute specifies the output register value at power on for Port A and the INIT\_B attribute specifies the value for Port B. You can use the SRVAL\_A attribute to define the state resulting from assertion of the SSR (set/reset) input on Port A. You can use the SRVAL\_B attribute to define the state resulting from assertion of the SSR input on Port B.

The INIT\_A, INIT\_B, SRVAL\_A, and SRVAL\_B attributes specify the initialization value as a hexadecimal String. The value is dependent upon the port width. For example, for a RAMB16\_S1\_S4 with Port A width equal to 1 and Port B width equal to 4, the Port A output register contains 1 bit and the Port B output register contains 4 bits. Therefore, the INIT\_A or SRVAL\_A value can only be specified as a 1 or 0. For Port B, the output register contains 4 bits. In this case, you can use INIT\_B or SRVAL\_B to specify a hexadecimal value from 0 through F to initialize the 4 bits of the output register.

For those ports that include parity bits, the parity portion of the output register is specified in the high order bit position of the INIT\_A, INIT\_B, SRVAL\_A, or SRVAL\_B value.

The INIT and SRVAL attributes default to zero if they are not set by you.

#### Write Mode Selection

The WRITE\_MODE\_A attribute controls the memory and output contents of Port A for a dual-port RAMB16. The WRITE\_MODE\_B attribute does the same for Port B. By default, both WRITE\_MODE\_A and WRITE\_MODE\_B are set to WRITE\_FIRST. This means that input is read, written to memory, and then passed to output. You can set the write mode for Port A and Port B to READ\_FIRST to read the memory contents, pass the memory contents to the outputs, and then write the input to memory. Or, you can set the write mode to NO\_CHANGE to have the input written to memory without changing the output. The "Port A and Port B Conflict Resolution" section describes how read/write conflicts are resolved when both Port A and Port B are attempting to read/write to the same memory cells.

#### Port A and Port B Conflict Resolution

Spartan-3A block SelectRAM is True Dual-Port RAM that allows both ports to simultaneously access the same memory cell. When one port writes to a given memory cell, the other port must not address that memory cell (for a write or a read) within the clock-to-clock setup window.

The following tables summarize the collision detection behavior of the dual-port RAMB16 based on the WRITE\_MODE\_A and WRITE\_MODE\_B settings.

*WRITE\_MODE\_A=NO\_CHANGE and WRITE\_MODE\_B=NO\_CHANGE*

WEA	WEB	CLKA	CLKB	DIA	DIB	DIPA	DIPB	DOA	DOB	DOPA	DOPB	Data RAM	Parity Ram
0	0	↑	↑	DIA	DIB	DIPA	DIPB	RAM	RAM	RAM	RAM	No Change	No Change
1	0	↑	↑	DIA	DIB	DIPA	DIPB	No Change	X	No Change	X	DIA	DIPA
0	1	↑	↑	DIA	DIB	DIPA	DIPB	X	No Change	X	No Change	DIB	DIPB
1	1	↑	↑	DIA	DIB	DIPA	DIPB	No Change	No Change	No Change	No Change	X	X

*WRITE\_MODE\_A=READ\_FIRST and WRITE\_MODE\_B=READ\_FIRST*

WEA	WEB	CLKA	CLKB	DIA	DIB	DIPA	DIPB	DOA	DOB	DOPA	DOPB	Data RAM	Parity Ram
0	0	↑	↑	DIA	DIB	DIPA	DIPB	RAM	RAM	RAM	RAM	No Change	No Change
1	0	↑	↑	DIA	DIB	DIPA	DIPB	RAM	RAM	RAM	RAM	DIA	DIPA
0	1	↑	↑	DIA	DIB	DIPA	DIPB	RAM	RAM	RAM	RAM	DIB	DIPB
1	1	↑	↑	DIA	DIB	DIPA	DIPB	RAM	RAM	RAM	RAM	X	X

*WRITE\_MODE\_A=WRITE\_FIRST and WRITE\_MODE\_B=WRITE\_FIRST*

WEA	WEB	CLKA	CLKB	DIA	DIB	DIPA	DIPB	DOA	DOB	DOPA	DOPB	Data RAM	Parity Ram
0	0	↑	↑	DIA	DIB	DIPA	DIPB	RAM	RAM	RAM	RAM	No Change	No Change
1	0	↑	↑	DIA	DIB	DIPA	DIPB	DIA	X	DIPA	X	DIA	DIPA
0	1	↑	↑	DIA	DIB	DIPA	DIPB	X	DIB	X	DIPB	DIB	DIPB
1	1	↑	↑	DIA	DIB	DIPA	DIPB	X	X	X	X	X	X

*WRITE\_MODE\_A=NO\_CHANGE and WRITE\_MODE\_B=READ\_FIRST*

WEA	WEB	CLKA	CLKB	DIA	DIB	DIPA	DIPB	DOA	DOB	DOPA	DOPB	Data RAM	Parity Ram
0	0	↑	↑	DIA	DIB	DIPA	DIPB	RAM	RAM	RAM	RAM	No Change	No Change
1	0	↑	↑	DIA	DIB	DIPA	DIPB	No Change	X	No Change	X	DIA	DIPA
0	1	↑	↑	DIA	DIB	DIPA	DIPB	RAM	RAM	RAM	RAM	DIB	DIPB
1	1	↑	↑	DIA	DIB	DIPA	DIPB	No Change	X	No Change	X	DIB	DIPB

*WRITE\_MODE\_A=NO\_CHANGE and WRITE\_MODE\_B=WRITE\_FIRST*

WEA	WEB	CLKA	CLKB	DIA	DIB	DIPA	DIPB	DOA	DOB	DOPA	DOPB	Data RAM	Parity Ram
0	0	↑	↑	DIA	DIB	DIPA	DIPB	RAM	RAM	RAM	RAM	No Change	No Change
1	0	↑	↑	DIA	DIB	DIPA	DIPB	No Change	X	No Change	X	DIA	DIPA

WEA	WEB	CLKA	CLKB	DIA	DIB	DIPA	DIPB	DOA	DOB	DOPA	DOPB	Data RAM	Parity Ram
0	1	↑	↑	DIA	DIB	DIPA	DIPB	X	DIB	X	DIPB	DIB	DIPB
1	1	↑	↑	DIA	DIB	DIPA	DIPB	No Change	X	No Change	X	X	X

WRITE\_MODE\_A=READ\_FIRST and WRITE\_MODE\_B=WRITE\_FIRST

WEA	WEB	CLKA	CLKB	DIA	DIB	DIPA	DIPB	DOA	DOB	DOPA	DOPB	Data RAM	Parity Ram
0	0	↑	↑	DIA	DIB	DIPA	DIPB	RAM	RAM	RAM	RAM	No Change	No Change
1	0	↑	↑	DIA	DIB	DIPA	DIPB	RAM	RAM	RAM	RAM	DIA	DIPA
0	1	↑	↑	DIA	DIB	DIPA	DIPB	X	DIB	X	DIPB	DIB	DIPB
1	1	↑	↑	DIA	DIB	DIPA	DIPB	X	DIB	X	DIPB	DIA	DIPA

## Design Entry Method

This design element can be used in schematics.

## Available Attributes

Attribute	Type	Allowed Values	Default	Description
INIT_00 To INIT_3F	Binary/Hexadecimal	Any	All zeros	Specifies the initial contents of the data portion of the RAM array.
INIT_A	Binary/Hexadecimal	Any	All zeros	Identifies the initial value of the DOA/DOB output port after completing configuration. For Type, the bit width is dependent on the width of the A or B port of the RAM.
INIT_B	Binary/Hexadecimal	Any	All zeros	Identifies the initial value of the DOA/DOB output port after completing configuration. For Type, the bit width is dependent on the width of the A or B port of the RAM.
INITP_00 To INITP_07	Binary/Hexadecimal	Any	All zeros	Specifies the initial contents of the parity portion of the RAM array.
SIM_COLLISION_CHECK	String	"ALL", "NONE", "WARNING", or "GENERATE_X_ONLY"	"ALL"	Specifies the behavior during simulation in the event of a data collision (data being read or written to the same address from both ports of the Ram simultaneously. "ALL" issues a warning to simulator console and generate an X or all unknown data due to the collision. This is the recommended setting. "WARNING" generates a warning only and "GENERATE_X_ONLY" generates an X for unknown data but won't output the occurrence to the simulation console. "NONE" completely ignores the error. It is suggested to only change this attribute if you can ensure the data generated during a collision is discarded.

Attribute	Type	Allowed Values	Default	Description
SRVAL_A	Binary/Hexadecimal	Any	All zeros	Allows the individual selection of whether the DOA/DOB output port sets (go to a one) or reset (go to a zero) upon the assertion of the RSTA pin. For Type, the bit width is dependent on the width of the A port of the RAM.
SRVAL_B	Binary/Hexadecimal	Any	All zeros	Allows the individual selection of whether the DOA/DOB output port sets (go to a one) or reset (go to a zero) upon the assertion of the RSTB pin. For Type, the bit width is dependent on the width of the B port of the RAM.
WRITE_MODE_A	String	"WRITE_FIRST", "READ_FIRST" or "NO_CHANGE"	"WRITE_FIRST"	Specifies the behavior of the DOA/DOB port upon a write command to the respected port. If set to WRITE_FIRST, the same port that is written to displays the contents of the written data to the outputs upon completion of the operation. "READ_FIRST" displays the prior contents of the RAM to the output port prior to writing the new data. "NO_CHANGE" keeps the previous value on the output port and won't update the output port upon a write command. This is the suggested mode if not using the read data from a particular port of the RAM
WRITE_MODE_B	String	"WRITE_FIRST", "READ_FIRST" or "NO_CHANGE"	"WRITE_FIRST"	Specifies the behavior of the DOA/DOB port upon a write command to the respected port. If set to WRITE_FIRST, the same port that is written to displays the contents of the written data to the outputs upon completion of the operation. "READ_FIRST" displays the prior contents of the RAM to the output port prior to writing the new data. "NO_CHANGE" keeps the previous value on the output port and won't update the output port upon a write command. This is the suggested mode if not using the read data from a particular port of the RAM.

## For More Information

- See the [Spartan-3 User Guide](#).
- See the [Spartan-3 Data Sheets](#).

## RAMB16\_S4

Primitive: 16K-bit Data and 2K-bit Parity Single-Port Synchronous Block RAM with 4-bit Port

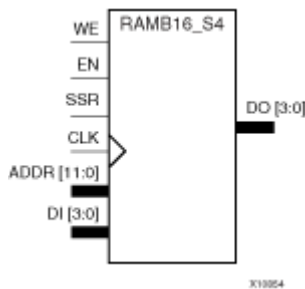

### Introduction

This design element is a dedicated random access memory blocks with synchronous write capability. The block RAM port has 16384 bits of data memory.

The enable ENA pin controls read, write, and reset for Port A. When ENA is Low, no data is written and the outputs (DOA and DOPA) retain the last state. When ENA is High and reset (SSRA) is High, DOA and DOPA are set to SRVAL\_A during the Low-to-High clock (CLKA) transition; if write enable (WEA) is High, the memory contents reflect the data at DIA and DIPA. When ENA is High and WEA is Low, the data stored in the RAM address (ADDRA) is read during the Low-to-High clock transition. By default, WRITE\_MODE\_A=WRITE\_FIRST, when ENA and WEA are High, the data on the data inputs (DIA and DIPA) is loaded into the word selected by the write address (ADDRA) during the Low-to-High clock transition and the data outputs (DOA and DOPA) reflect the selected (addressed) word.

The above description assumes an active High EN, WE, SSR, and CLK. However, the active level can be changed by placing an inverter on the port. Any inverter placed on a RAMB16 port is absorbed into the block and does not use a CLB resource.

The cell configuration for this element is listed in the following table.

	Data Cells		Parity Cells				
Component	Depth	Width	Depth	Width	Address Bus	Data Bus	Parity Bus
RAMB16_S4	4096	4	-	-	(11:0)	(3:0)	-

### Design Entry Method

This design element can be used in schematics.

### Available Attributes

Attribute	Type	Allowed Values	Default	Description
INIT	Binary	Any Hex Value	All zeros	Identifies the initial value of the DO output port after completing configuration. The bit width is dependent on the width of the A or B port of the RAM.
INIT_00 - INIT_3F	Binary	Any Hex Value	All zeros	Specifies the initial contents of the data portion of the RAM array.
INITP_00 - INITP_07	Binary	Any Hex Value	All zeros	Specifies the initial contents of the parity portion of the RAM array.

Attribute	Type	Allowed Values	Default	Description
SRVAL	Binary	Any Hex Value	All zeros	Allows the individual selection of whether the DO output port sets (go to a one) or reset (go to a zero) upon the assertion of the SSR pin. The bit width is dependent on the width of the A or B port of the RAM.
WRITE_MODE	String	"WRITE_FIRST", "READ_FIRST" or "NO_CHANGE"	"WRITE_FIRST"	Specifies the behavior of the DO port upon a write command to the respected port. If set to "WRITE_FIRST", the same port that is written to displays the contents of the written data to the outputs upon completion of the operation. "READ_FIRST" displays the prior contents of the RAM to the output port prior to writing the new data. "NO_CHANGE" keeps the previous value on the output port and won't update the output port upon a write command. This is the suggested mode if not using the read data from a particular port of the RAM.

### For More Information

- See the [Spartan-3 User Guide](#).
- See the [Spartan-3 Data Sheets](#).

# RAMB16\_S4\_S18

Primitive: 16K-bit Data and 2K-bit Parity Dual-Port Synchronous Block RAM with 4-bit and 18-bit Ports

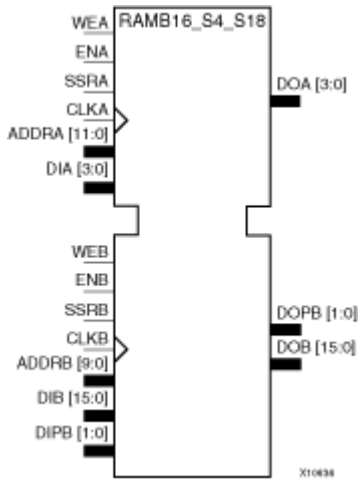

## Introduction

This design element is a dual-ported dedicated random access memory block with synchronous write capability. Each block RAM port has 16384 bits of data memory. Ports configured as 9, 18, or 36-bits wide have an additional 2048 bits of parity memory. Each port is independent of the other while accessing the same set of 16384 data memory cells. Each port is independently configured to a specific data width. The possible port and cell configurations for this element are listed under "Port Descriptions."

## Logic Table

Truth Table A

Inputs								Outputs			
GSR	ENA	SSRA	WEA	CLKA	ADDR_A	DIA	DIPA	DOA	DOPA	RAM Contents	
										Data RAM	Parity RAM
1	X	X	X	X	X	X	X	INIT_A	INIT_A	No Change	No Change
0	0	X	X	X	X	X	X	No Change	No Change	No Change	No Change
0	1	1	0	↑	X	X	X	SRVAL_A	SRVAL_A	No Change	No Change
0	1	1	1	↑	addr	data	pdata	SRVAL_A	SRVAL_A	RAM(addr) =>data	RAM(addr) =>pdata
0	1	0	0	↑	addr	X	X	RAM(addr)	RAM(addr)	No Change	No Change

Inputs								Outputs			
GSR	ENA	SSRA	WEA	CLKA	ADDRA	DIA	DIPA	DOA	DOPA	RAM Contents	
										Data RAM	Parity RAM
0	1	0	1	↑	addr	data	pdata	No Change1, RAM (addr)2, data3	No Change1, RAM (addr)2, pdata3	RAM(addr) =>data	RAM(addr) =>pdata

GSR=Global Set Reset  
 INIT\_A=Value specified by the INIT\_A attribute for output register. Default is all zeros.  
 SRVAL\_A=register value.  
 addr=RAM address.  
 RAM(addr)=RAM contents at address ADDR.  
 data=RAM input data.  
 pdata=RAM parity data.  
 1WRITE\_MODE\_A=NO\_CHANGE.  
 2WRITE\_MODE\_A=READ\_FIRST.  
 3WRITE\_MODE\_A=WRITE\_FIRST.

Truth Table B

Inputs								Outputs			
GSR	ENB	SSRB	WEB	CLKB	ADDRB	DIB	DIPB	DOB	DOPB	RAM Contents	
										Data RAM	Parity RAM
1	X	X	X	X	X	X	X	INIT_B	INIT_B	No Change	No Change
0	0	X	X	X	X	X	X	No Change	No Change	No Change	No Change
0	1	1	0	↑	X	X	X	SRVAL_B	SRVAL_B	No Change	No Change
0	1	1	1	↑	addr	data	pdata	SRVAL_B	SRVAL_B	RAM(addr) =>data	RAM(addr) =>pdata
0	1	0	0	↑	addr	X	X	RAM(addr)	RAM(addr)	No Change	No Change
0	1	0	1	↑	addr	data	pdata	No Change1, RAM (addr)2, data3	No Change1, RAM (addr)2, pdata3	RAM(addr)2	RAM(addr) =>pdata

GSR=Global Set Reset.  
 INIT\_B=Value specified by the INIT\_B attribute for output registers. Default is all zeros.  
 SRVAL\_B=register value.  
 addr=RAM address.  
 RAM(addr)=RAM contents at address ADDR.  
 data=RAM input data.  
 pdata=RAM parity data.  
 1WRITE\_MODE\_B=NO\_CHANGE.  
 2WRITE\_MODE\_B=READ\_FIRST.  
 3WRITE\_MODE\_B=WRITE\_FIRST.



## Port Descriptions

Port A						Port B				
Design Element	Data Cells(a)	Parity Cells(a)	Address Bus	Data Bus	Parity Bus	Data Cells(a)	Parity Cells(a)	Address Bus	Data Bus	Parity Bus
RAMB16_S4_S18	4096 x 4	-	(11:0)	(3:0)	-	1024 x 16	1024 x 2	(9:0)	(15:0)	(1:0)
(a)Depth x Width										

Each port is fully synchronous with independent clock pins. All Port A input pins have setup time referenced to the CLKA pin and its data output bus DOA has a clock-to-out time referenced to the CLKA. All Port B input pins have setup time referenced to the CLKB pin and its data output bus DOB has a clock-to-out time referenced to the CLKB. The enable ENA pin controls read, write, and reset for Port A. When ENA is Low, no data is written and the outputs (DOA and DOPA) retain the last state. When ENA is High and reset (SSRA) is High, DOA and DOPA are set to SRVAL\_A during the Low-to-High clock (CLKA) transition; if write enable (WEA) is High, the memory contents reflect the data at DIA and DIPA. When ENA is High and WEA is Low, the data stored in the RAM address (ADDRA) is read during the Low-to-High clock transition. By default, WRITE\_MODE\_A=WRITE\_FIRST, when ENA and WEA are High, the data on the data inputs (DIA and DIPA) is loaded into the word selected by the write address (ADDRA) during the Low-to-High clock transition and the data outputs (DOA and DOPA) reflect the selected (addressed) word.

The enable ENB pin controls read, write, and reset for Port B. When ENB is Low, no data is written and the outputs (DOB and DOPB) retain the last state. When ENB is High and reset (SSRB) is High, DOB and DOPB are set to SRVAL\_B during the Low-to-High clock (CLKB) transition; if write enable (WEB) is High, the memory contents reflect the data at DIB and DIPB. When ENB is High and WEB is Low, the data stored in the RAM address (ADDRB) is read during the Low-to-High clock transition. By default, WRITE\_MODE\_B=WRITE\_FIRST, when ENB and WEB are High, the data on the data inputs (DIB and DIPB) are loaded into the word selected by the write address (ADDRB) during the Low-to-High clock transition and the data outputs (DOB and DOPB) reflect the selected (addressed) word. The above descriptions assume active High control pins (ENA, WEA, SSRA, CLKA, ENB, WEB, SSRB, and CLKB). However, the active level can be changed by placing an inverter on the port. Any inverter placed on a RAMB16 port is absorbed into the block and does not use a CLB resource.

### Address Mapping

Each port accesses the same set of 18432 memory cells using an addressing scheme that is dependent on the width of the port. For all port widths, 16384 memory cells are available for data as shown in the "Port Address Mapping for Data" table below. For 9-, 18-, and 36-bit wide ports, 2408 parity memory cells are also available as shown in "Port Address Mapping for Parity" table below. The physical RAM location that is addressed for a particular width is determined from the following formula.

$$\text{Start} = ((\text{ADDR}_{\text{port}} + 1) * (\text{Width}_{\text{port}})) - 1$$

$$\text{End} = (\text{ADDR}_{\text{port}}) * (\text{Width}_{\text{port}})$$

### Port Address Mapping for Data

Data Width	Port Data Addresses	31	30	29	28	27	26	25	24	23	22	21	20	19	18	17	16	15	14	13	12	11	10	9	8	7	6	5	4	3	2	1	0	
1	16384	<--																																
2	8192	<--	15		14		13		12		11		10		9		8		7		6		5		4		3		2		1		0	
4	4096	<--	7			6				5				4				3				2				1					0			
8	2048	<--	3							2								1								0								
16	1024	<--	1															0																
32	512	<--	0																															

### Port Address Mapping for Parity

Parity Width	Port Parity Addresses																
1	2048	<-----	3					2					1				0
2	1024	<-----	1										0				
4	512	<-----	0														

#### Initializing Memory Contents of a Dual-Port RAMB16

You can use the INIT\_xx attributes to specify an initialization value for the memory contents of a RAMB16 during device configuration. The initialization of each RAMB16\_Sm\_Sn is set by 64 initialization attributes (INIT\_00 through INIT\_3F) of 64 hex values for a total of 16384 bits.

You can use the INITP\_xx attributes to specify an initial value for the parity memory during device configuration or assertion. The initialization of the parity memory for ports configured for 9, 18, or 36 bits is set by 8 initialization attributes (INITP\_00 through INITP\_07) of 64 hex values for a total of 2048 bits.

If any INIT\_xx or INITP\_xx attribute is not specified, it is configured as zeros. Partial Strings are padded with zeros to the left.

#### Initializing the Output Register of a Dual-Port RAMB16

In Spartan-3A, each bit in an output register can be initialized at power on (when GSR is high) to either a 0 or 1. In addition, the initial state specified for power on can be different than the state that results from assertion of a set/reset. Four properties control initialization of the output register for a dual-port RAMB16: INIT\_A, INIT\_B, SRVAL\_A, and SRVAL\_B. The INIT\_A attribute specifies the output register value at power on for Port A and the INIT\_B attribute specifies the value for Port B. You can use the SRVAL\_A attribute to define the state resulting from assertion of the SSR (set/reset) input on Port A. You can use the SRVAL\_B attribute to define the state resulting from assertion of the SSR input on Port B.

The INIT\_A, INIT\_B, SRVAL\_A, and SRVAL\_B attributes specify the initialization value as a hexadecimal String. The value is dependent upon the port width. For example, for a RAMB16\_S1\_S4 with Port A width equal to 1 and Port B width equal to 4, the Port A output register contains 1 bit and the Port B output register contains 4 bits. Therefore, the INIT\_A or SRVAL\_A value can only be specified as a 1 or 0. For Port B, the output register contains 4 bits. In this case, you can use INIT\_B or SRVAL\_B to specify a hexadecimal value from 0 through F to initialize the 4 bits of the output register.

For those ports that include parity bits, the parity portion of the output register is specified in the high order bit position of the INIT\_A, INIT\_B, SRVAL\_A, or SRVAL\_B value.

The INIT and SRVAL attributes default to zero if they are not set by you.

#### Write Mode Selection

The WRITE\_MODE\_A attribute controls the memory and output contents of Port A for a dual-port RAMB16. The WRITE\_MODE\_B attribute does the same for Port B. By default, both WRITE\_MODE\_A and WRITE\_MODE\_B are set to WRITE\_FIRST. This means that input is read, written to memory, and then passed to output. You can set the write mode for Port A and Port B to READ\_FIRST to read the memory contents, pass the memory contents to the outputs, and then write the input to memory. Or, you can set the write mode to NO\_CHANGE to have the input written to memory without changing the output. The "Port A and Port B Conflict Resolution" section describes how read/write conflicts are resolved when both Port A and Port B are attempting to read/write to the same memory cells.

#### Port A and Port B Conflict Resolution

Spartan-3A block SelectRAM is True Dual-Port RAM that allows both ports to simultaneously access the same memory cell. When one port writes to a given memory cell, the other port must not address that memory cell (for a write or a read) within the clock-to-clock setup window.

The following tables summarize the collision detection behavior of the dual-port RAMB16 based on the WRITE\_MODE\_A and WRITE\_MODE\_B settings.

*WRITE\_MODE\_A=NO\_CHANGE and WRITE\_MODE\_B=NO\_CHANGE*

WEA	WEB	CLKA	CLKB	DIA	DIB	DIPA	DIPB	DOA	DOB	DOPA	DOPB	Data RAM	Parity Ram
0	0	↑	↑	DIA	DIB	DIPA	DIPB	RAM	RAM	RAM	RAM	No Change	No Change
1	0	↑	↑	DIA	DIB	DIPA	DIPB	No Change	X	No Change	X	DIA	DIPA
0	1	↑	↑	DIA	DIB	DIPA	DIPB	X	No Change	X	No Change	DIB	DIPB
1	1	↑	↑	DIA	DIB	DIPA	DIPB	No Change	No Change	No Change	No Change	X	X

WRITE\_MODE\_A=READ\_FIRST and WRITE\_MODE\_B=READ\_FIRST

WEA	WEB	CLKA	CLKB	DIA	DIB	DIPA	DIPB	DOA	DOB	DOPA	DOPB	Data RAM	Parity Ram
0	0	↑	↑	DIA	DIB	DIPA	DIPB	RAM	RAM	RAM	RAM	No Change	No Change
1	0	↑	↑	DIA	DIB	DIPA	DIPB	RAM	RAM	RAM	RAM	DIA	DIPA
0	1	↑	↑	DIA	DIB	DIPA	DIPB	RAM	RAM	RAM	RAM	DIB	DIPB
1	1	↑	↑	DIA	DIB	DIPA	DIPB	RAM	RAM	RAM	RAM	X	X

WRITE\_MODE\_A= WRITE\_FIRST and WRITE\_MODE\_B=WRITE\_FIRST

WEA	WEB	CLKA	CLKB	DIA	DIB	DIPA	DIPB	DOA	DOB	DOPA	DOPB	Data RAM	Parity Ram
0	0	↑	↑	DIA	DIB	DIPA	DIPB	RAM	RAM	RAM	RAM	No Change	No Change
1	0	↑	↑	DIA	DIB	DIPA	DIPB	DIA	X	DIPA	X	DIA	DIPA
0	1	↑	↑	DIA	DIB	DIPA	DIPB	X	DIB	X	DIPB	DIB	DIPB
1	1	↑	↑	DIA	DIB	DIPA	DIPB	X	X	X	X	X	X

WRITE\_MODE\_A=NO\_CHANGE and WRITE\_MODE\_B=READ\_FIRST

WEA	WEB	CLKA	CLKB	DIA	DIB	DIPA	DIPB	DOA	DOB	DOPA	DOPB	Data RAM	Parity Ram
0	0	↑	↑	DIA	DIB	DIPA	DIPB	RAM	RAM	RAM	RAM	No Change	No Change
1	0	↑	↑	DIA	DIB	DIPA	DIPB	No Change	X	No Change	X	DIA	DIPA
0	1	↑	↑	DIA	DIB	DIPA	DIPB	RAM	RAM	RAM	RAM	DIB	DIPB
1	1	↑	↑	DIA	DIB	DIPA	DIPB	No Change	X	No Change	X	DIB	DIPB

WRITE\_MODE\_A=NO\_CHANGE and WRITE\_MODE\_B=WRITE\_FIRST

WEA	WEB	CLKA	CLKB	DIA	DIB	DIPA	DIPB	DOA	DOB	DOPA	DOPB	Data RAM	Parity Ram
0	0	↑	↑	DIA	DIB	DIPA	DIPB	RAM	RAM	RAM	RAM	No Change	No Change
1	0	↑	↑	DIA	DIB	DIPA	DIPB	No Change	X	No Change	X	DIA	DIPA

WEA	WEB	CLKA	CLKB	DIA	DIB	DIPA	DIPB	DOA	DOB	DOPA	DOPB	Data RAM	Parity Ram
0	1	↑	↑	DIA	DIB	DIPA	DIPB	X	DIB	X	DIPB	DIB	DIPB
1	1	↑	↑	DIA	DIB	DIPA	DIPB	No Change	X	No Change	X	X	X

WRITE\_MODE\_A=READ\_FIRST and WRITE\_MODE\_B=WRITE\_FIRST

WEA	WEB	CLKA	CLKB	DIA	DIB	DIPA	DIPB	DOA	DOB	DOPA	DOPB	Data RAM	Parity Ram
0	0	↑	↑	DIA	DIB	DIPA	DIPB	RAM	RAM	RAM	RAM	No Change	No Change
1	0	↑	↑	DIA	DIB	DIPA	DIPB	RAM	RAM	RAM	RAM	DIA	DIPA
0	1	↑	↑	DIA	DIB	DIPA	DIPB	X	DIB	X	DIPB	DIB	DIPB
1	1	↑	↑	DIA	DIB	DIPA	DIPB	X	DIB	X	DIPB	DIA	DIPA

## Design Entry Method

This design element can be used in schematics.

## Available Attributes

Attribute	Type	Allowed Values	Default	Description
INIT_00 To INIT_3F	Binary/Hexadecimal	Any	All zeros	Specifies the initial contents of the data portion of the RAM array.
INIT_A	Binary/Hexadecimal	Any	All zeros	Identifies the initial value of the DOA/DOB output port after completing configuration. For Type, the bit width is dependent on the width of the A or B port of the RAM.
INIT_B	Binary/Hexadecimal	Any	All zeros	Identifies the initial value of the DOA/DOB output port after completing configuration. For Type, the bit width is dependent on the width of the A or B port of the RAM.
INITP_00 To INITP_07	Binary/Hexadecimal	Any	All zeros	Specifies the initial contents of the parity portion of the RAM array.
SIM_COLLISION_CHECK	String	"ALL", "NONE", "WARNING", or "GENERATE_X_ONLY"	"ALL"	Specifies the behavior during simulation in the event of a data collision (data being read or written to the same address from both ports of the Ram simultaneously. "ALL" issues a warning to simulator console and generate an X or all unknown data due to the collision. This is the recommended setting. "WARNING" generates a warning only and "GENERATE_X_ONLY" generates an X for unknown data but won't output the occurrence to the simulation console. "NONE" completely ignores the error. It is suggested to only change this attribute if you can ensure the data generated during a collision is discarded.

Attribute	Type	Allowed Values	Default	Description
SRVAL_A	Binary/Hexadecimal	Any	All zeros	Allows the individual selection of whether the DOA/DOB output port sets (go to a one) or reset (go to a zero) upon the assertion of the RSTA pin. For Type, the bit width is dependent on the width of the A port of the RAM.
SRVAL_B	Binary/Hexadecimal	Any	All zeros	Allows the individual selection of whether the DOA/DOB output port sets (go to a one) or reset (go to a zero) upon the assertion of the RSTB pin. For Type, the bit width is dependent on the width of the B port of the RAM.
WRITE_MODE_A	String	"WRITE_FIRST", "READ_FIRST" or "NO_CHANGE"	"WRITE_FIRST"	Specifies the behavior of the DOA/DOB port upon a write command to the respected port. If set to WRITE_FIRST, the same port that is written to displays the contents of the written data to the outputs upon completion of the operation. "READ_FIRST" displays the prior contents of the RAM to the output port prior to writing the new data. "NO_CHANGE" keeps the previous value on the output port and won't update the output port upon a write command. This is the suggested mode if not using the read data from a particular port of the RAM
WRITE_MODE_B	String	"WRITE_FIRST", "READ_FIRST" or "NO_CHANGE"	"WRITE_FIRST"	Specifies the behavior of the DOA/DOB port upon a write command to the respected port. If set to WRITE_FIRST, the same port that is written to displays the contents of the written data to the outputs upon completion of the operation. "READ_FIRST" displays the prior contents of the RAM to the output port prior to writing the new data. "NO_CHANGE" keeps the previous value on the output port and won't update the output port upon a write command. This is the suggested mode if not using the read data from a particular port of the RAM.

## For More Information

- See the [Spartan-3 User Guide](#).
- See the [Spartan-3 Data Sheets](#).

# RAMB16\_S4\_S36

Primitive: 16K-bit Data and 2K-bit Parity Dual-Port Synchronous Block RAM with 4-bit and 36-bit Ports

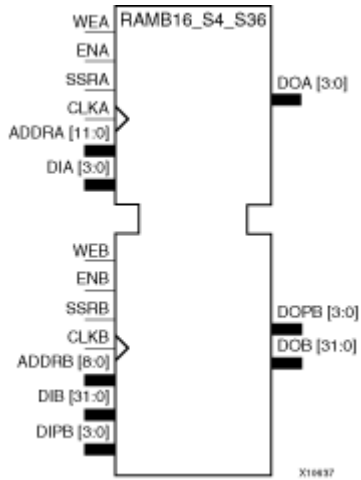

## Introduction

This design element is a dual-ported dedicated random access memory block with synchronous write capability. Each block RAM port has 16384 bits of data memory. Ports configured as 9, 18, or 36-bits wide have an additional 2048 bits of parity memory. Each port is independent of the other while accessing the same set of 16384 data memory cells. Each port is independently configured to a specific data width. The possible port and cell configurations for this element are listed under "Port Descriptions."

## Logic Table

Truth Table A

Inputs								Outputs			
GSR	ENA	SSRA	WEA	CLKA	ADDR_A	DIA	DIPA	DOA	DOPA	RAM Contents	
										Data RAM	Parity RAM
1	X	X	X	X	X	X	X	INIT_A	INIT_A	No Change	No Change
0	0	X	X	X	X	X	X	No Change	No Change	No Change	No Change
0	1	1	0	↑	X	X	X	SRVAL_A	SRVAL_A	No Change	No Change
0	1	1	1	↑	addr	data	pdata	SRVAL_A	SRVAL_A	RAM(addr) =>data	RAM(addr) =>pdata
0	1	0	0	↑	addr	X	X	RAM(addr)	RAM(addr)	No Change	No Change

Inputs								Outputs				
GSR	ENA	SSRA	WEA	CLKA	ADDRA	DIA	DIPA	DOA	DOPA	RAM Contents		
										Data RAM	Parity RAM	
0	1	0	1	↑	addr	data	pdata	No Change1, RAM (addr)2, data3	No Change1, RAM (addr)2, pdata3	RAM(addr) =>data	RAM(addr) =>pdata	

GSR=Global Set Reset  
 INIT\_A=Value specified by the INIT\_A attribute for output register. Default is all zeros.  
 SRVAL\_A=register value.  
 addr=RAM address.  
 RAM(addr)=RAM contents at address ADDR.  
 data=RAM input data.  
 pdata=RAM parity data.  
 1WRITE\_MODE\_A=NO\_CHANGE.  
 2WRITE\_MODE\_A=READ\_FIRST.  
 3WRITE\_MODE\_A=WRITE\_FIRST.

Truth Table B

Inputs								Outputs				
GSR	ENB	SSRB	WEB	CLKB	ADDRB	DIB	DIPB	DOB	DOPB	RAM Contents		
										Data RAM	Parity RAM	
1	X	X	X	X	X	X	X	INIT_B	INIT_B	No Change	No Change	
0	0	X	X	X	X	X	X	No Change	No Change	No Change	No Change	
0	1	1	0	↑	X	X	X	SRVAL_B	SRVAL_B	No Change	No Change	
0	1	1	1	↑	addr	data	pdata	SRVAL_B	SRVAL_B	RAM(addr) =>data	RAM(addr) =>pdata	
0	1	0	0	↑	addr	X	X	RAM(addr)	RAM(addr)	No Change	No Change	
0	1	0	1	↑	addr	data	pdata	No Change1, RAM (addr)2, data3	No Change1, RAM (addr)2, pdata3	RAM(addr)2	RAM(addr) =>pdata	

GSR=Global Set Reset.  
 INIT\_B=Value specified by the INIT\_B attribute for output registers. Default is all zeros.  
 SRVAL\_B=register value.  
 addr=RAM address.  
 RAM(addr)=RAM contents at address ADDR.  
 data=RAM input data.  
 pdata=RAM parity data.  
 1WRITE\_MODE\_B=NO\_CHANGE.  
 2WRITE\_MODE\_B=READ\_FIRST.

See the ISE 10.1 User Guide for Schematic Designs

## Port Descriptions

Port A						Port B				
Design Element	Data Cells(a)	Parity Cells(a)	Address Bus	Data Bus	Parity Bus	Data Cells(a)	Parity Cells(a)	Address Bus	Data Bus	Parity Bus
RAMB16_S4_S36	4096 x 4	-	(11:0)	(3:0)	-	512 x 32	512 x 4	(8:0)	(31:0)	(3:0)
(a)Depth x Width										

Each port is fully synchronous with independent clock pins. All Port A input pins have setup time referenced to the CLKA pin and its data output bus DOA has a clock-to-out time referenced to the CLKA. All Port B input pins have setup time referenced to the CLKB pin and its data output bus DOB has a clock-to-out time referenced to the CLKB. The enable ENA pin controls read, write, and reset for Port A. When ENA is Low, no data is written and the outputs (DOA and DOPA) retain the last state. When ENA is High and reset (SSRA) is High, DOA and DOPA are set to SRVAL\_A during the Low-to-High clock (CLKA) transition; if write enable (WEA) is High, the memory contents reflect the data at DIA and DIPA. When ENA is High and WEA is Low, the data stored in the RAM address (ADDRA) is read during the Low-to-High clock transition. By default, WRITE\_MODE\_A=WRITE\_FIRST, when ENA and WEA are High, the data on the data inputs (DIA and DIPA) is loaded into the word selected by the write address (ADDRA) during the Low-to-High clock transition and the data outputs (DOA and DOPA) reflect the selected (addressed) word.

The enable ENB pin controls read, write, and reset for Port B. When ENB is Low, no data is written and the outputs (DOB and DOPB) retain the last state. When ENB is High and reset (SSRB) is High, DOB and DOPB are set to SRVAL\_B during the Low-to-High clock (CLKB) transition; if write enable (WEB) is High, the memory contents reflect the data at DIB and DIPB. When ENB is High and WEB is Low, the data stored in the RAM address (ADDRB) is read during the Low-to-High clock transition. By default, WRITE\_MODE\_B=WRITE\_FIRST, when ENB and WEB are High, the data on the data inputs (DIB and DIPB) are loaded into the word selected by the write address (ADDRB) during the Low-to-High clock transition and the data outputs (DOB and DOPB) reflect the selected (addressed) word. The above descriptions assume active High control pins (ENA, WEA, SSRA, CLKA, ENB, WEB, SSRB, and CLKB). However, the active level can be changed by placing an inverter on the port. Any inverter placed on a RAMB16 port is absorbed into the block and does not use a CLB resource.

### Address Mapping

Each port accesses the same set of 18432 memory cells using an addressing scheme that is dependent on the width of the port. For all port widths, 16384 memory cells are available for data as shown in the "Port Address Mapping for Data" table below. For 9-, 18-, and 36-bit wide ports, 2408 parity memory cells are also available as shown in "Port Address Mapping for Parity" table below. The physical RAM location that is addressed for a particular width is determined from the following formula.

$$\text{Start} = ((\text{ADDR}_{\text{port}} + 1) * (\text{Width}_{\text{port}})) - 1$$

$$\text{End} = (\text{ADDR}_{\text{port}}) * (\text{Width}_{\text{port}})$$

The following tables shows address mapping for each port width.

### Port Address Mapping for Data

Data Width	Port Data Addresses	31	30	29	28	27	26	25	24	23	22	21	20	19	18	17	16	15	14	13	12	11	10	9	8	7	6	5	4	3	2	1	0		
1	16384	<--																																	
2	8192	<--	15		14		13		12		11		10		9		8		7		6		5		4		3		2		1		0		
4	4096	<--	7			6				5				4								2					1					0			
8	2048	<--	3							2																	0								
16	1024	<--	1																																
32	512	<--	0																																

### Port Address Mapping for Parity



Parity Width	Port Parity Addresses																
1	2048	<-----	3					2					1				0
2	1024	<-----	1										0				
4	512	<-----	0														

#### Initializing Memory Contents of a Dual-Port RAMB16

You can use the INIT\_xx attributes to specify an initialization value for the memory contents of a RAMB16 during device configuration. The initialization of each RAMB16\_Sm\_Sn is set by 64 initialization attributes (INIT\_00 through INIT\_3F) of 64 hex values for a total of 16384 bits.

You can use the INITP\_xx attributes to specify an initial value for the parity memory during device configuration or assertion. The initialization of the parity memory for ports configured for 9, 18, or 36 bits is set by 8 initialization attributes (INITP\_00 through INITP\_07) of 64 hex values for a total of 2048 bits.

If any INIT\_xx or INITP\_xx attribute is not specified, it is configured as zeros. Partial Strings are padded with zeros to the left.

#### Initializing the Output Register of a Dual-Port RAMB16

In Spartan-3A, each bit in an output register can be initialized at power on (when GSR is high) to either a 0 or 1. In addition, the initial state specified for power on can be different than the state that results from assertion of a set/reset. Four properties control initialization of the output register for a dual-port RAMB16: INIT\_A, INIT\_B, SRVAL\_A, and SRVAL\_B. The INIT\_A attribute specifies the output register value at power on for Port A and the INIT\_B attribute specifies the value for Port B. You can use the SRVAL\_A attribute to define the state resulting from assertion of the SSR (set/reset) input on Port A. You can use the SRVAL\_B attribute to define the state resulting from assertion of the SSR input on Port B.

The INIT\_A, INIT\_B, SRVAL\_A, and SRVAL\_B attributes specify the initialization value as a hexadecimal String. The value is dependent upon the port width. For example, for a RAMB16\_S1\_S4 with Port A width equal to 1 and Port B width equal to 4, the Port A output register contains 1 bit and the Port B output register contains 4 bits. Therefore, the INIT\_A or SRVAL\_A value can only be specified as a 1 or 0. For Port B, the output register contains 4 bits. In this case, you can use INIT\_B or SRVAL\_B to specify a hexadecimal value from 0 through F to initialize the 4 bits of the output register.

For those ports that include parity bits, the parity portion of the output register is specified in the high order bit position of the INIT\_A, INIT\_B, SRVAL\_A, or SRVAL\_B value.

The INIT and SRVAL attributes default to zero if they are not set by you.

#### Write Mode Selection

The WRITE\_MODE\_A attribute controls the memory and output contents of Port A for a dual-port RAMB16. The WRITE\_MODE\_B attribute does the same for Port B. By default, both WRITE\_MODE\_A and WRITE\_MODE\_B are set to WRITE\_FIRST. This means that input is read, written to memory, and then passed to output. You can set the write mode for Port A and Port B to READ\_FIRST to read the memory contents, pass the memory contents to the outputs, and then write the input to memory. Or, you can set the write mode to NO\_CHANGE to have the input written to memory without changing the output. The "Port A and Port B Conflict Resolution" section describes how read/write conflicts are resolved when both Port A and Port B are attempting to read/write to the same memory cells.

#### Port A and Port B Conflict Resolution

Spartan-3A block SelectRAM is True Dual-Port RAM that allows both ports to simultaneously access the same memory cell. When one port writes to a given memory cell, the other port must not address that memory cell (for a write or a read) within the clock-to-clock setup window.

The following tables summarize the collision detection behavior of the dual-port RAMB16 based on the WRITE\_MODE\_A and WRITE\_MODE\_B settings.

WRITE\_MODE\_A=NO\_CHANGE and WRITE\_MODE\_B=NO\_CHANGE

WEA	WEB	CLKA	CLKB	DIA	DIB	DIPA	DIPB	DOA	DOB	DOPA	DOPB	Data RAM	Parity Ram
0	0	↑	↑	DIA	DIB	DIPA	DIPB	RAM	RAM	RAM	RAM	No Change	No Change
1	0	↑	↑	DIA	DIB	DIPA	DIPB	No Change	X	No Change	X	DIA	DIPA
0	1	↑	↑	DIA	DIB	DIPA	DIPB	X	No Change	X	No Change	DIB	DIPB
1	1	↑	↑	DIA	DIB	DIPA	DIPB	No Change	No Change	No Change	No Change	X	X

*WRITE\_MODE\_A=READ\_FIRST and WRITE\_MODE\_B=READ\_FIRST*

WEA	WEB	CLKA	CLKB	DIA	DIB	DIPA	DIPB	DOA	DOB	DOPA	DOPB	Data RAM	Parity Ram
0	0	↑	↑	DIA	DIB	DIPA	DIPB	RAM	RAM	RAM	RAM	No Change	No Change
1	0	↑	↑	DIA	DIB	DIPA	DIPB	RAM	RAM	RAM	RAM	DIA	DIPA
0	1	↑	↑	DIA	DIB	DIPA	DIPB	RAM	RAM	RAM	RAM	DIB	DIPB
1	1	↑	↑	DIA	DIB	DIPA	DIPB	RAM	RAM	RAM	RAM	X	X

*WRITE\_MODE\_A=WRITE\_FIRST and WRITE\_MODE\_B=WRITE\_FIRST*

WEA	WEB	CLKA	CLKB	DIA	DIB	DIPA	DIPB	DOA	DOB	DOPA	DOPB	Data RAM	Parity Ram
0	0	↑	↑	DIA	DIB	DIPA	DIPB	RAM	RAM	RAM	RAM	No Change	No Change
1	0	↑	↑	DIA	DIB	DIPA	DIPB	DIA	X	DIPA	X	DIA	DIPA
0	1	↑	↑	DIA	DIB	DIPA	DIPB	X	DIB	X	DIPB	DIB	DIPB
1	1	↑	↑	DIA	DIB	DIPA	DIPB	X	X	X	X	X	X

*WRITE\_MODE\_A=NO\_CHANGE and WRITE\_MODE\_B=READ\_FIRST*

WEA	WEB	CLKA	CLKB	DIA	DIB	DIPA	DIPB	DOA	DOB	DOPA	DOPB	Data RAM	Parity Ram
0	0	↑	↑	DIA	DIB	DIPA	DIPB	RAM	RAM	RAM	RAM	No Change	No Change
1	0	↑	↑	DIA	DIB	DIPA	DIPB	No Change	X	No Change	X	DIA	DIPA
0	1	↑	↑	DIA	DIB	DIPA	DIPB	RAM	RAM	RAM	RAM	DIB	DIPB
1	1	↑	↑	DIA	DIB	DIPA	DIPB	No Change	X	No Change	X	DIB	DIPB

*WRITE\_MODE\_A=NO\_CHANGE and WRITE\_MODE\_B=WRITE\_FIRST*

WEA	WEB	CLKA	CLKB	DIA	DIB	DIPA	DIPB	DOA	DOB	DOPA	DOPB	Data RAM	Parity Ram
0	0	↑	↑	DIA	DIB	DIPA	DIPB	RAM	RAM	RAM	RAM	No Change	No Change
1	0	↑	↑	DIA	DIB	DIPA	DIPB	No Change	X	No Change	X	DIA	DIPA

WEA	WEB	CLKA	CLKB	DIA	DIB	DIPA	DIPB	DOA	DOB	DOPA	DOPB	Data RAM	Parity Ram
0	1	↑	↑	DIA	DIB	DIPA	DIPB	X	DIB	X	DIPB	DIB	DIPB
1	1	↑	↑	DIA	DIB	DIPA	DIPB	No Change	X	No Change	X	X	X

WRITE\_MODE\_A=READ\_FIRST and WRITE\_MODE\_B=WRITE\_FIRST

WEA	WEB	CLKA	CLKB	DIA	DIB	DIPA	DIPB	DOA	DOB	DOPA	DOPB	Data RAM	Parity Ram
0	0	↑	↑	DIA	DIB	DIPA	DIPB	RAM	RAM	RAM	RAM	No Change	No Change
1	0	↑	↑	DIA	DIB	DIPA	DIPB	RAM	RAM	RAM	RAM	DIA	DIPA
0	1	↑	↑	DIA	DIB	DIPA	DIPB	X	DIB	X	DIPB	DIB	DIPB
1	1	↑	↑	DIA	DIB	DIPA	DIPB	X	DIB	X	DIPB	DIA	DIPA

## Design Entry Method

This design element can be used in schematics.

## Available Attributes

Attribute	Type	Allowed Values	Default	Description
INIT_00 To INIT_3F	Binary/Hexadecimal	Any	All zeros	Specifies the initial contents of the data portion of the RAM array.
INIT_A	Binary/Hexadecimal	Any	All zeros	Identifies the initial value of the DOA/DOB output port after completing configuration. For Type, the bit width is dependent on the width of the A or B port of the RAM.
INIT_B	Binary/Hexadecimal	Any	All zeros	Identifies the initial value of the DOA/DOB output port after completing configuration. For Type, the bit width is dependent on the width of the A or B port of the RAM.
INITP_00 To INITP_07	Binary/Hexadecimal	Any	All zeros	Specifies the initial contents of the parity portion of the RAM array.
SIM_COLLISION_CHECK	String	"ALL", "NONE", "WARNING", or "GENERATE_X_ONLY"	"ALL"	Specifies the behavior during simulation in the event of a data collision (data being read or written to the same address from both ports of the Ram simultaneously. "ALL" issues a warning to simulator console and generate an X or all unknown data due to the collision. This is the recommended setting. "WARNING" generates a warning only and "GENERATE_X_ONLY" generates an X for unknown data but won't output the occurrence to the simulation console. "NONE" completely ignores the error. It is suggested to only change this attribute if you can ensure the data generated during a collision is discarded.

Attribute	Type	Allowed Values	Default	Description
SRVAL_A	Binary/Hexadecimal	Any	All zeros	Allows the individual selection of whether the DOA/DOB output port sets (go to a one) or reset (go to a zero) upon the assertion of the RSTA pin. For Type, the bit width is dependent on the width of the A port of the RAM.
SRVAL_B	Binary/Hexadecimal	Any	All zeros	Allows the individual selection of whether the DOA/DOB output port sets (go to a one) or reset (go to a zero) upon the assertion of the RSTB pin. For Type, the bit width is dependent on the width of the B port of the RAM.
WRITE_MODE_A	String	"WRITE_FIRST", "READ_FIRST" or "NO_CHANGE"	"WRITE_FIRST"	Specifies the behavior of the DOA/DOB port upon a write command to the respected port. If set to WRITE_FIRST, the same port that is written to displays the contents of the written data to the outputs upon completion of the operation. "READ_FIRST" displays the prior contents of the RAM to the output port prior to writing the new data. "NO_CHANGE" keeps the previous value on the output port and won't update the output port upon a write command. This is the suggested mode if not using the read data from a particular port of the RAM
WRITE_MODE_B	String	"WRITE_FIRST", "READ_FIRST" or "NO_CHANGE"	"WRITE_FIRST"	Specifies the behavior of the DOA/DOB port upon a write command to the respected port. If set to WRITE_FIRST, the same port that is written to displays the contents of the written data to the outputs upon completion of the operation. "READ_FIRST" displays the prior contents of the RAM to the output port prior to writing the new data. "NO_CHANGE" keeps the previous value on the output port and won't update the output port upon a write command. This is the suggested mode if not using the read data from a particular port of the RAM.

## For More Information

- See the [Spartan-3 User Guide](#).
- See the [Spartan-3 Data Sheets](#).

# RAMB16\_S4\_S4

Primitive: 16K-bit Data and 2K-bit Parity Dual-Port Synchronous Block RAM with 4-bit Ports

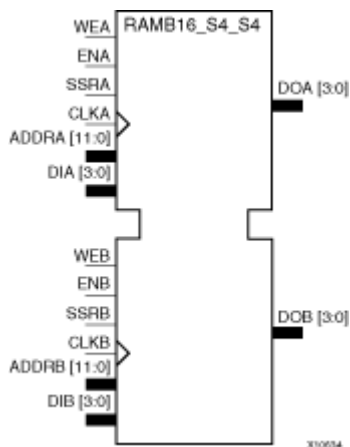

## Introduction

This design element is a dual-ported dedicated random access memory block with synchronous write capability. Each block RAM port has 16384 bits of data memory. Ports configured as 9, 18, or 36-bits wide have an additional 2048 bits of parity memory. Each port is independent of the other while accessing the same set of 16384 data memory cells. Each port is independently configured to a specific data width. The possible port and cell configurations for this element are listed under "Port Descriptions."

## Logic Table

Truth Table A

Inputs								Outputs			
GSR	ENA	SSRA	WEA	CLKA	ADDR_A	DIA	DIPA	DOA	DOPA	RAM Contents	
										Data RAM	Parity RAM
1	X	X	X	X	X	X	X	INIT_A	INIT_A	No Change	No Change
0	0	X	X	X	X	X	X	No Change	No Change	No Change	No Change
0	1	1	0	↑	X	X	X	SRVAL_A	SRVAL_A	No Change	No Change
0	1	1	1	↑	addr	data	pdata	SRVAL_A	SRVAL_A	RAM(addr) =>data	RAM(addr) =>pdata
0	1	0	0	↑	addr	X	X	RAM(addr)	RAM(addr)	No Change	No Change

Inputs								Outputs			
GSR	ENA	SSRA	WEA	CLKA	ADDRA	DIA	DIPA	DOA	DOPA	RAM Contents	
										Data RAM	Parity RAM
0	1	0	1	↑	addr	data	pdata	No Change1, RAM (addr)2, data3	No Change1, RAM (addr)2, pdata3	RAM(addr) =>data	RAM(addr) =>pdata

GSR=Global Set Reset  
 INIT\_A=Value specified by the INIT\_A attribute for output register. Default is all zeros.  
 SRVAL\_A=register value.  
 addr=RAM address.  
 RAM(addr)=RAM contents at address ADDR.  
 data=RAM input data.  
 pdata=RAM parity data.  
 1WRITE\_MODE\_A=NO\_CHANGE.  
 2WRITE\_MODE\_A=READ\_FIRST.  
 3WRITE\_MODE\_A=WRITE\_FIRST.

Truth Table B

Inputs								Outputs			
GSR	ENB	SSRB	WEB	CLKB	ADDRB	DIB	DIPB	DOB	DOPB	RAM Contents	
										Data RAM	Parity RAM
1	X	X	X	X	X	X	X	INIT_B	INIT_B	No Change	No Change
0	0	X	X	X	X	X	X	No Change	No Change	No Change	No Change
0	1	1	0	↑	X	X	X	SRVAL_B	SRVAL_B	No Change	No Change
0	1	1	1	↑	addr	data	pdata	SRVAL_B	SRVAL_B	RAM(addr) =>data	RAM(addr) =>pdata
0	1	0	0	↑	addr	X	X	RAM(addr)	RAM(addr)	No Change	No Change
0	1	0	1	↑	addr	data	pdata	No Change1, RAM (addr)2, data3	No Change1, RAM (addr)2, pdata3	RAM(addr)2	RAM(addr) =>pdata

GSR=Global Set Reset.  
 INIT\_B=Value specified by the INIT\_B attribute for output registers. Default is all zeros.  
 SRVAL\_B=register value.  
 addr=RAM address.  
 RAM(addr)=RAM contents at address ADDR.  
 data=RAM input data.  
 pdata=RAM parity data.  
 1WRITE\_MODE\_B=NO\_CHANGE.  
 2WRITE\_MODE\_B=READ\_FIRST.  
 3WRITE\_MODE\_B=WRITE\_FIRST.

## Port Descriptions

Port A						Port B				
Design Element	Data Cells(a)	Parity Cells(a)	Address Bus	Data Bus	Parity Bus	Data Cells(a)	Parity Cells(a)	Address Bus	Data Bus	Parity Bus
RAMB16_S4_S4	4096 x 4	-	(11:0)	(3:0)	-	4096 x 4	-	(11:0)	(3:0)	-
(a)Depth x Width										

Each port is fully synchronous with independent clock pins. All Port A input pins have setup time referenced to the CLKA pin and its data output bus DOA has a clock-to-out time referenced to the CLKA. All Port B input pins have setup time referenced to the CLKB pin and its data output bus DOB has a clock-to-out time referenced to the CLKB. The enable ENA pin controls read, write, and reset for Port A. When ENA is Low, no data is written and the outputs (DOA and DOPA) retain the last state. When ENA is High and reset (SSRA) is High, DOA and DOPA are set to SRVAL\_A during the Low-to-High clock (CLKA) transition; if write enable (WEA) is High, the memory contents reflect the data at DIA and DIPA. When ENA is High and WEA is Low, the data stored in the RAM address (ADDRA) is read during the Low-to-High clock transition. By default, WRITE\_MODE\_A=WRITE\_FIRST, when ENA and WEA are High, the data on the data inputs (DIA and DIPA) is loaded into the word selected by the write address (ADDRA) during the Low-to-High clock transition and the data outputs (DOA and DOPA) reflect the selected (addressed) word.

The enable ENB pin controls read, write, and reset for Port B. When ENB is Low, no data is written and the outputs (DOB and DOPB) retain the last state. When ENB is High and reset (SSRB) is High, DOB and DOPB are set to SRVAL\_B during the Low-to-High clock (CLKB) transition; if write enable (WEB) is High, the memory contents reflect the data at DIB and DIPB. When ENB is High and WEB is Low, the data stored in the RAM address (ADDRB) is read during the Low-to-High clock transition. By default, WRITE\_MODE\_B=WRITE\_FIRST, when ENB and WEB are High, the data on the data inputs (DIB and DIPB) are loaded into the word selected by the write address (ADDRB) during the Low-to-High clock transition and the data outputs (DOB and DOPB) reflect the selected (addressed) word. The above descriptions assume active High control pins (ENA, WEA, SSRA, CLKA, ENB, WEB, SSRB, and CLKB). However, the active level can be changed by placing an inverter on the port. Any inverter placed on a RAMB16 port is absorbed into the block and does not use a CLB resource.

### Address Mapping

Each port accesses the same set of 18432 memory cells using an addressing scheme that is dependent on the width of the port. For all port widths, 16384 memory cells are available for data as shown in the "Port Address Mapping for Data" table below. For 9-, 18-, and 36-bit wide ports, 2408 parity memory cells are also available as shown in "Port Address Mapping for Parity" table below. The physical RAM location that is addressed for a particular width is determined from the following formula.

$$\text{Start} = ((\text{ADDR}_{\text{port}} + 1) * (\text{Width}_{\text{port}})) - 1$$

$$\text{End} = (\text{ADDR}_{\text{port}}) * (\text{Width}_{\text{port}})$$

The following tables shows address mapping for each port width.

### Port Address Mapping for Data

Data Width	Port Data Addresses																																			
1	16384	<--	31	30	29	28	27	26	25	24	23	22	21	20	19	18	17	16	15	14	13	12	11	10	9	8	7	6	5	4	3	2	1	0		
2	8192	<--	15		14		13		12		11		10		9		8		7		6		5		4		3		2		1		0			
4	4096	<--	7				6				5				4				3				2					1				0				
8	2048	<--	3								2								1									0								
16	1024	<--	1																0																	
32	512	<--	0																																	

### Port Address Mapping for Parity

Parity Width	Port Parity Addresses														
1	2048	<-----	3				2					1			0
2	1024	<-----	1									0			
4	512	<-----	0												

#### Initializing Memory Contents of a Dual-Port RAMB16

You can use the INIT\_xx attributes to specify an initialization value for the memory contents of a RAMB16 during device configuration. The initialization of each RAMB16\_Sm\_Sn is set by 64 initialization attributes (INIT\_00 through INIT\_3F) of 64 hex values for a total of 16384 bits.

You can use the INITP\_xx attributes to specify an initial value for the parity memory during device configuration or assertion. The initialization of the parity memory for ports configured for 9, 18, or 36 bits is set by 8 initialization attributes (INITP\_00 through INITP\_07) of 64 hex values for a total of 2048 bits.

If any INIT\_xx or INITP\_xx attribute is not specified, it is configured as zeros. Partial Strings are padded with zeros to the left.

#### Initializing the Output Register of a Dual-Port RAMB16

In Spartan-3A, each bit in an output register can be initialized at power on (when GSR is high) to either a 0 or 1. In addition, the initial state specified for power on can be different than the state that results from assertion of a set/reset. Four properties control initialization of the output register for a dual-port RAMB16: INIT\_A, INIT\_B, SRVAL\_A, and SRVAL\_B. The INIT\_A attribute specifies the output register value at power on for Port A and the INIT\_B attribute specifies the value for Port B. You can use the SRVAL\_A attribute to define the state resulting from assertion of the SSR (set/reset) input on Port A. You can use the SRVAL\_B attribute to define the state resulting from assertion of the SSR input on Port B.

The INIT\_A, INIT\_B, SRVAL\_A, and SRVAL\_B attributes specify the initialization value as a hexadecimal String. The value is dependent upon the port width. For example, for a RAMB16\_S1\_S4 with Port A width equal to 1 and Port B width equal to 4, the Port A output register contains 1 bit and the Port B output register contains 4 bits. Therefore, the INIT\_A or SRVAL\_A value can only be specified as a 1 or 0. For Port B, the output register contains 4 bits. In this case, you can use INIT\_B or SRVAL\_B to specify a hexadecimal value from 0 through F to initialize the 4 bits of the output register.

For those ports that include parity bits, the parity portion of the output register is specified in the high order bit position of the INIT\_A, INIT\_B, SRVAL\_A, or SRVAL\_B value.

The INIT and SRVAL attributes default to zero if they are not set by you.

#### Write Mode Selection

The WRITE\_MODE\_A attribute controls the memory and output contents of Port A for a dual-port RAMB16. The WRITE\_MODE\_B attribute does the same for Port B. By default, both WRITE\_MODE\_A and WRITE\_MODE\_B are set to WRITE\_FIRST. This means that input is read, written to memory, and then passed to output. You can set the write mode for Port A and Port B to READ\_FIRST to read the memory contents, pass the memory contents to the outputs, and then write the input to memory. Or, you can set the write mode to NO\_CHANGE to have the input written to memory without changing the output. The "Port A and Port B Conflict Resolution" section describes how read/write conflicts are resolved when both Port A and Port B are attempting to read/write to the same memory cells.

#### Port A and Port B Conflict Resolution

Spartan-3A block SelectRAM is True Dual-Port RAM that allows both ports to simultaneously access the same memory cell. When one port writes to a given memory cell, the other port must not address that memory cell (for a write or a read) within the clock-to-clock setup window.

The following tables summarize the collision detection behavior of the dual-port RAMB16 based on the WRITE\_MODE\_A and WRITE\_MODE\_B settings.

*WRITE\_MODE\_A=NO\_CHANGE and WRITE\_MODE\_B=NO\_CHANGE*



WEA	WEB	CLKA	CLKB	DIA	DIB	DIPA	DIPB	DOA	DOB	DOPA	DOPB	Data RAM	Parity Ram
0	0	↑	↑	DIA	DIB	DIPA	DIPB	RAM	RAM	RAM	RAM	No Change	No Change
1	0	↑	↑	DIA	DIB	DIPA	DIPB	No Change	X	No Change	X	DIA	DIPA
0	1	↑	↑	DIA	DIB	DIPA	DIPB	X	No Change	X	No Change	DIB	DIPB
1	1	↑	↑	DIA	DIB	DIPA	DIPB	No Change	No Change	No Change	No Change	X	X

WRITE\_MODE\_A=READ\_FIRST and WRITE\_MODE\_B=READ\_FIRST

WEA	WEB	CLKA	CLKB	DIA	DIB	DIPA	DIPB	DOA	DOB	DOPA	DOPB	Data RAM	Parity Ram
0	0	↑	↑	DIA	DIB	DIPA	DIPB	RAM	RAM	RAM	RAM	No Change	No Change
1	0	↑	↑	DIA	DIB	DIPA	DIPB	RAM	RAM	RAM	RAM	DIA	DIPA
0	1	↑	↑	DIA	DIB	DIPA	DIPB	RAM	RAM	RAM	RAM	DIB	DIPB
1	1	↑	↑	DIA	DIB	DIPA	DIPB	RAM	RAM	RAM	RAM	X	X

WRITE\_MODE\_A= WRITE\_FIRST and WRITE\_MODE\_B=WRITE\_FIRST

WEA	WEB	CLKA	CLKB	DIA	DIB	DIPA	DIPB	DOA	DOB	DOPA	DOPB	Data RAM	Parity Ram
0	0	↑	↑	DIA	DIB	DIPA	DIPB	RAM	RAM	RAM	RAM	No Change	No Change
1	0	↑	↑	DIA	DIB	DIPA	DIPB	DIA	X	DIPA	X	DIA	DIPA
0	1	↑	↑	DIA	DIB	DIPA	DIPB	X	DIB	X	DIPB	DIB	DIPB
1	1	↑	↑	DIA	DIB	DIPA	DIPB	X	X	X	X	X	X

WRITE\_MODE\_A=NO\_CHANGE and WRITE\_MODE\_B=READ\_FIRST

WEA	WEB	CLKA	CLKB	DIA	DIB	DIPA	DIPB	DOA	DOB	DOPA	DOPB	Data RAM	Parity Ram
0	0	↑	↑	DIA	DIB	DIPA	DIPB	RAM	RAM	RAM	RAM	No Change	No Change
1	0	↑	↑	DIA	DIB	DIPA	DIPB	No Change	X	No Change	X	DIA	DIPA
0	1	↑	↑	DIA	DIB	DIPA	DIPB	RAM	RAM	RAM	RAM	DIB	DIPB
1	1	↑	↑	DIA	DIB	DIPA	DIPB	No Change	X	No Change	X	DIB	DIPB

WRITE\_MODE\_A=NO\_CHANGE and WRITE\_MODE\_B=WRITE\_FIRST

WEA	WEB	CLKA	CLKB	DIA	DIB	DIPA	DIPB	DOA	DOB	DOPA	DOPB	Data RAM	Parity Ram
0	0	↑	↑	DIA	DIB	DIPA	DIPB	RAM	RAM	RAM	RAM	No Change	No Change
1	0	↑	↑	DIA	DIB	DIPA	DIPB	No Change	X	No Change	X	DIA	DIPA

WEA	WEB	CLKA	CLKB	DIA	DIB	DIPA	DIPB	DOA	DOB	DOPA	DOPB	Data RAM	Parity Ram
0	1	↑	↑	DIA	DIB	DIPA	DIPB	X	DIB	X	DIPB	DIB	DIPB
1	1	↑	↑	DIA	DIB	DIPA	DIPB	No Change	X	No Change	X	X	X

*WRITE\_MODE\_A=READ\_FIRST and WRITE\_MODE\_B=WRITE\_FIRST*

WEA	WEB	CLKA	CLKB	DIA	DIB	DIPA	DIPB	DOA	DOB	DOPA	DOPB	Data RAM	Parity Ram
0	0	↑	↑	DIA	DIB	DIPA	DIPB	RAM	RAM	RAM	RAM	No Change	No Change
1	0	↑	↑	DIA	DIB	DIPA	DIPB	RAM	RAM	RAM	RAM	DIA	DIPA
0	1	↑	↑	DIA	DIB	DIPA	DIPB	X	DIB	X	DIPB	DIB	DIPB
1	1	↑	↑	DIA	DIB	DIPA	DIPB	X	DIB	X	DIPB	DIA	DIPA

## Design Entry Method

This design element can be used in schematics.

## Available Attributes

Attribute	Type	Allowed Values	Default	Description
INIT_00 To INIT_3F	Binary/Hexadecimal	Any	All zeros	Specifies the initial contents of the data portion of the RAM array.
INIT_A	Binary/Hexadecimal	Any	All zeros	Identifies the initial value of the DOA/DOB output port after completing configuration. For Type, the bit width is dependent on the width of the A or B port of the RAM.
INIT_B	Binary/Hexadecimal	Any	All zeros	Identifies the initial value of the DOA/DOB output port after completing configuration. For Type, the bit width is dependent on the width of the A or B port of the RAM.
INITP_00 To INITP_07	Binary/Hexadecimal	Any	All zeros	Specifies the initial contents of the parity portion of the RAM array.
SIM_COLLISION_CHECK	String	"ALL", "NONE", "WARNING", or "GENERATE_X_ONLY"	"ALL"	Specifies the behavior during simulation in the event of a data collision (data being read or written to the same address from both ports of the Ram simultaneously. "ALL" issues a warning to simulator console and generate an X or all unknown data due to the collision. This is the recommended setting. "WARNING" generates a warning only and "GENERATE_X_ONLY" generates an X for unknown data but won't output the occurrence to the simulation console. "NONE" completely ignores the error. It is suggested to only change this attribute if you can ensure the data generated during a collision is discarded.

Attribute	Type	Allowed Values	Default	Description
SRVAL_A	Binary/Hexadecimal	Any	All zeros	Allows the individual selection of whether the DOA/DOB output port sets (go to a one) or reset (go to a zero) upon the assertion of the RSTA pin. For Type, the bit width is dependent on the width of the A port of the RAM.
SRVAL_B	Binary/Hexadecimal	Any	All zeros	Allows the individual selection of whether the DOA/DOB output port sets (go to a one) or reset (go to a zero) upon the assertion of the RSTB pin. For Type, the bit width is dependent on the width of the B port of the RAM.
WRITE_MODE_A	String	"WRITE_FIRST", "READ_FIRST" or "NO_CHANGE"	"WRITE_FIRST"	Specifies the behavior of the DOA/DOB port upon a write command to the respected port. If set to WRITE_FIRST, the same port that is written to displays the contents of the written data to the outputs upon completion of the operation. "READ_FIRST" displays the prior contents of the RAM to the output port prior to writing the new data. "NO_CHANGE" keeps the previous value on the output port and won't update the output port upon a write command. This is the suggested mode if not using the read data from a particular port of the RAM
WRITE_MODE_B	String	"WRITE_FIRST", "READ_FIRST" or "NO_CHANGE"	"WRITE_FIRST"	Specifies the behavior of the DOA/DOB port upon a write command to the respected port. If set to WRITE_FIRST, the same port that is written to displays the contents of the written data to the outputs upon completion of the operation. "READ_FIRST" displays the prior contents of the RAM to the output port prior to writing the new data. "NO_CHANGE" keeps the previous value on the output port and won't update the output port upon a write command. This is the suggested mode if not using the read data from a particular port of the RAM.

## For More Information

- See the [Spartan-3 User Guide](#).
- See the [Spartan-3 Data Sheets](#).

# RAMB16\_S4\_S9

Primitive: 16K-bit Data and 2K-bit Parity Dual-Port Synchronous Block RAM with 4-bit and 9-bit Ports

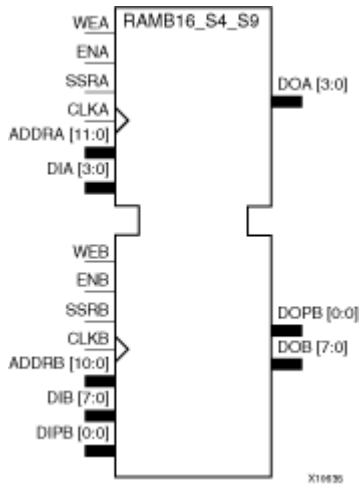

## Introduction

This design element is a dual-ported dedicated random access memory block with synchronous write capability. Each block RAM port has 16384 bits of data memory. Ports configured as 9, 18, or 36-bits wide have an additional 2048 bits of parity memory. Each port is independent of the other while accessing the same set of 16384 data memory cells. Each port is independently configured to a specific data width. The possible port and cell configurations for this element are listed under "Port Descriptions."

## Logic Table

Truth Table A

Inputs								Outputs			
GSR	ENA	SSRA	WEA	CLKA	ADDR_A	DIA	DIPA	DOA	DOPA	RAM Contents	
										Data RAM	Parity RAM
1	X	X	X	X	X	X	X	INIT_A	INIT_A	No Change	No Change
0	0	X	X	X	X	X	X	No Change	No Change	No Change	No Change
0	1	1	0	↑	X	X	X	SRVAL_A	SRVAL_A	No Change	No Change
0	1	1	1	↑	addr	data	pdata	SRVAL_A	SRVAL_A	RAM(addr) =>data	RAM(addr) =>pdata
0	1	0	0	↑	addr	X	X	RAM(addr)	RAM(addr)	No Change	No Change

Inputs								Outputs			
GSR	ENA	SSRA	WEA	CLKA	ADDRA	DIA	DIPA	DOA	DOPA	RAM Contents	
										Data RAM	Parity RAM
0	1	0	1	↑	addr	data	pdata	No Change1, RAM (addr)2, data3	No Change1, RAM (addr)2, pdata3	RAM(addr) =>data	RAM(addr) =>pdata

GSR=Global Set Reset  
 INIT\_A=Value specified by the INIT\_A attribute for output register. Default is all zeros.  
 SRVAL\_A=register value.  
 addr=RAM address.  
 RAM(addr)=RAM contents at address ADDR.  
 data=RAM input data.  
 pdata=RAM parity data.  
 1WRITE\_MODE\_A=NO\_CHANGE.  
 2WRITE\_MODE\_A=READ\_FIRST.  
 3WRITE\_MODE\_A=WRITE\_FIRST.

Truth Table B

Inputs								Outputs			
GSR	ENB	SSRB	WEB	CLKB	ADDRB	DIB	DIPB	DOB	DOPB	RAM Contents	
										Data RAM	Parity RAM
1	X	X	X	X	X	X	X	INIT_B	INIT_B	No Change	No Change
0	0	X	X	X	X	X	X	No Change	No Change	No Change	No Change
0	1	1	0	↑	X	X	X	SRVAL_B	SRVAL_B	No Change	No Change
0	1	1	1	↑	addr	data	pdata	SRVAL_B	SRVAL_B	RAM(addr) =>data	RAM(addr) =>pdata
0	1	0	0	↑	addr	X	X	RAM(addr)	RAM(addr)	No Change	No Change
0	1	0	1	↑	addr	data	pdata	No Change1, RAM (addr)2, data3	No Change1, RAM (addr)2, pdata3	RAM(addr)2	RAM(addr) =>pdata

GSR=Global Set Reset.  
 INIT\_B=Value specified by the INIT\_B attribute for output registers. Default is all zeros.  
 SRVAL\_B=register value.  
 addr=RAM address.  
 RAM(addr)=RAM contents at address ADDR.  
 data=RAM input data.  
 pdata=RAM parity data.  
 1WRITE\_MODE\_B=NO\_CHANGE.  
 2WRITE\_MODE\_B=READ\_FIRST.

See the ISE 10.1 User Guide for Schematic Designs

## Port Descriptions

Port A						Port B				
Design Element	Data Cells(a)	Parity Cells(a)	Address Bus	Data Bus	Parity Bus	Data Cells(a)	Parity Cells(a)	Address Bus	Data Bus	Parity Bus
RAMB16_S4_S9	4096 x 4	-	(11:0)	(3:0)	-	2048 x 8	2048 x 1	(10:0)	(7:0)	(0:0)
(a)Depth x Width										

Each port is fully synchronous with independent clock pins. All Port A input pins have setup time referenced to the CLKA pin and its data output bus DOA has a clock-to-out time referenced to the CLKA. All Port B input pins have setup time referenced to the CLKB pin and its data output bus DOB has a clock-to-out time referenced to the CLKB. The enable ENA pin controls read, write, and reset for Port A. When ENA is Low, no data is written and the outputs (DOA and DOPA) retain the last state. When ENA is High and reset (SSRA) is High, DOA and DOPA are set to SRVAL\_A during the Low-to-High clock (CLKA) transition; if write enable (WEA) is High, the memory contents reflect the data at DIA and DIPA. When ENA is High and WEA is Low, the data stored in the RAM address (ADDRA) is read during the Low-to-High clock transition. By default, WRITE\_MODE\_A=WRITE\_FIRST, when ENA and WEA are High, the data on the data inputs (DIA and DIPA) is loaded into the word selected by the write address (ADDRA) during the Low-to-High clock transition and the data outputs (DOA and DOPA) reflect the selected (addressed) word.

The enable ENB pin controls read, write, and reset for Port B. When ENB is Low, no data is written and the outputs (DOB and DOPB) retain the last state. When ENB is High and reset (SSRB) is High, DOB and DOPB are set to SRVAL\_B during the Low-to-High clock (CLKB) transition; if write enable (WEB) is High, the memory contents reflect the data at DIB and DIPB. When ENB is High and WEB is Low, the data stored in the RAM address (ADDRB) is read during the Low-to-High clock transition. By default, WRITE\_MODE\_B=WRITE\_FIRST, when ENB and WEB are High, the data on the data inputs (DIB and DIPB) are loaded into the word selected by the write address (ADDRB) during the Low-to-High clock transition and the data outputs (DOB and DOPB) reflect the selected (addressed) word. The above descriptions assume active High control pins (ENA, WEA, SSRA, CLKA, ENB, WEB, SSRB, and CLKB). However, the active level can be changed by placing an inverter on the port. Any inverter placed on a RAMB16 port is absorbed into the block and does not use a CLB resource.

### Address Mapping

Each port accesses the same set of 18432 memory cells using an addressing scheme that is dependent on the width of the port. For all port widths, 16384 memory cells are available for data as shown in the "Port Address Mapping for Data" table below. For 9-, 18-, and 36-bit wide ports, 2408 parity memory cells are also available as shown in "Port Address Mapping for Parity" table below. The physical RAM location that is addressed for a particular width is determined from the following formula.

$$\text{Start} = ((\text{ADDR}_{\text{port}} + 1) * (\text{Width}_{\text{port}})) - 1$$

$$\text{End} = (\text{ADDR}_{\text{port}}) * (\text{Width}_{\text{port}})$$

The following tables shows address mapping for each port width.

### Port Address Mapping for Data

Data Width	Port Data Addresses																																		
1	16384	<--	31	30	29	28	27	26	25	24	23	22	21	20	19	18	17	16	15	14	13	12	11	10	9	8	7	6	5	4	3	2	1	0	
2	8192	<--	15		14		13		12		11		10		9		8		7		6		5		4		3		2		1		0		
4	4096	<--	7				6				5				4				3				2					1					0		
8	2048	<--	3								2								1									0							
16	1024	<--	1																0																
32	512	<--	0																																

### Port Address Mapping for Parity

Parity Width	Port Parity Addresses																
1	2048	<-----	3					2					1				0
2	1024	<-----	1										0				
4	512	<-----	0														

#### Initializing Memory Contents of a Dual-Port RAMB16

You can use the INIT\_xx attributes to specify an initialization value for the memory contents of a RAMB16 during device configuration. The initialization of each RAMB16\_Sm\_Sn is set by 64 initialization attributes (INIT\_00 through INIT\_3F) of 64 hex values for a total of 16384 bits.

You can use the INITP\_xx attributes to specify an initial value for the parity memory during device configuration or assertion. The initialization of the parity memory for ports configured for 9, 18, or 36 bits is set by 8 initialization attributes (INITP\_00 through INITP\_07) of 64 hex values for a total of 2048 bits.

If any INIT\_xx or INITP\_xx attribute is not specified, it is configured as zeros. Partial Strings are padded with zeros to the left.

#### Initializing the Output Register of a Dual-Port RAMB16

In Spartan-3A, each bit in an output register can be initialized at power on (when GSR is high) to either a 0 or 1. In addition, the initial state specified for power on can be different than the state that results from assertion of a set/reset. Four properties control initialization of the output register for a dual-port RAMB16: INIT\_A, INIT\_B, SRVAL\_A, and SRVAL\_B. The INIT\_A attribute specifies the output register value at power on for Port A and the INIT\_B attribute specifies the value for Port B. You can use the SRVAL\_A attribute to define the state resulting from assertion of the SSR (set/reset) input on Port A. You can use the SRVAL\_B attribute to define the state resulting from assertion of the SSR input on Port B.

The INIT\_A, INIT\_B, SRVAL\_A, and SRVAL\_B attributes specify the initialization value as a hexadecimal String. The value is dependent upon the port width. For example, for a RAMB16\_S1\_S4 with Port A width equal to 1 and Port B width equal to 4, the Port A output register contains 1 bit and the Port B output register contains 4 bits. Therefore, the INIT\_A or SRVAL\_A value can only be specified as a 1 or 0. For Port B, the output register contains 4 bits. In this case, you can use INIT\_B or SRVAL\_B to specify a hexadecimal value from 0 through F to initialize the 4 bits of the output register.

For those ports that include parity bits, the parity portion of the output register is specified in the high order bit position of the INIT\_A, INIT\_B, SRVAL\_A, or SRVAL\_B value.

The INIT and SRVAL attributes default to zero if they are not set by you.

#### Write Mode Selection

The WRITE\_MODE\_A attribute controls the memory and output contents of Port A for a dual-port RAMB16. The WRITE\_MODE\_B attribute does the same for Port B. By default, both WRITE\_MODE\_A and WRITE\_MODE\_B are set to WRITE\_FIRST. This means that input is read, written to memory, and then passed to output. You can set the write mode for Port A and Port B to READ\_FIRST to read the memory contents, pass the memory contents to the outputs, and then write the input to memory. Or, you can set the write mode to NO\_CHANGE to have the input written to memory without changing the output. The "Port A and Port B Conflict Resolution" section describes how read/write conflicts are resolved when both Port A and Port B are attempting to read/write to the same memory cells.

#### Port A and Port B Conflict Resolution

Spartan-3A block SelectRAM is True Dual-Port RAM that allows both ports to simultaneously access the same memory cell. When one port writes to a given memory cell, the other port must not address that memory cell (for a write or a read) within the clock-to-clock setup window.

The following tables summarize the collision detection behavior of the dual-port RAMB16 based on the WRITE\_MODE\_A and WRITE\_MODE\_B settings.

WRITE\_MODE\_A=NO\_CHANGE and WRITE\_MODE\_B=NO\_CHANGE

WEA	WEB	CLKA	CLKB	DIA	DIB	DIPA	DIPB	DOA	DOB	DOPA	DOPB	Data RAM	Parity Ram
0	0	↑	↑	DIA	DIB	DIPA	DIPB	RAM	RAM	RAM	RAM	No Change	No Change
1	0	↑	↑	DIA	DIB	DIPA	DIPB	No Change	X	No Change	X	DIA	DIPA
0	1	↑	↑	DIA	DIB	DIPA	DIPB	X	No Change	X	No Change	DIB	DIPB
1	1	↑	↑	DIA	DIB	DIPA	DIPB	No Change	No Change	No Change	No Change	X	X

*WRITE\_MODE\_A=READ\_FIRST and WRITE\_MODE\_B=READ\_FIRST*

WEA	WEB	CLKA	CLKB	DIA	DIB	DIPA	DIPB	DOA	DOB	DOPA	DOPB	Data RAM	Parity Ram
0	0	↑	↑	DIA	DIB	DIPA	DIPB	RAM	RAM	RAM	RAM	No Change	No Change
1	0	↑	↑	DIA	DIB	DIPA	DIPB	RAM	RAM	RAM	RAM	DIA	DIPA
0	1	↑	↑	DIA	DIB	DIPA	DIPB	RAM	RAM	RAM	RAM	DIB	DIPB
1	1	↑	↑	DIA	DIB	DIPA	DIPB	RAM	RAM	RAM	RAM	X	X

*WRITE\_MODE\_A=WRITE\_FIRST and WRITE\_MODE\_B=WRITE\_FIRST*

WEA	WEB	CLKA	CLKB	DIA	DIB	DIPA	DIPB	DOA	DOB	DOPA	DOPB	Data RAM	Parity Ram
0	0	↑	↑	DIA	DIB	DIPA	DIPB	RAM	RAM	RAM	RAM	No Change	No Change
1	0	↑	↑	DIA	DIB	DIPA	DIPB	DIA	X	DIPA	X	DIA	DIPA
0	1	↑	↑	DIA	DIB	DIPA	DIPB	X	DIB	X	DIPB	DIB	DIPB
1	1	↑	↑	DIA	DIB	DIPA	DIPB	X	X	X	X	X	X

*WRITE\_MODE\_A=NO\_CHANGE and WRITE\_MODE\_B=READ\_FIRST*

WEA	WEB	CLKA	CLKB	DIA	DIB	DIPA	DIPB	DOA	DOB	DOPA	DOPB	Data RAM	Parity Ram
0	0	↑	↑	DIA	DIB	DIPA	DIPB	RAM	RAM	RAM	RAM	No Change	No Change
1	0	↑	↑	DIA	DIB	DIPA	DIPB	No Change	X	No Change	X	DIA	DIPA
0	1	↑	↑	DIA	DIB	DIPA	DIPB	RAM	RAM	RAM	RAM	DIB	DIPB
1	1	↑	↑	DIA	DIB	DIPA	DIPB	No Change	X	No Change	X	DIB	DIPB

*WRITE\_MODE\_A=NO\_CHANGE and WRITE\_MODE\_B=WRITE\_FIRST*

WEA	WEB	CLKA	CLKB	DIA	DIB	DIPA	DIPB	DOA	DOB	DOPA	DOPB	Data RAM	Parity Ram
0	0	↑	↑	DIA	DIB	DIPA	DIPB	RAM	RAM	RAM	RAM	No Change	No Change
1	0	↑	↑	DIA	DIB	DIPA	DIPB	No Change	X	No Change	X	DIA	DIPA



WEA	WEB	CLKA	CLKB	DIA	DIB	DIPA	DIPB	DOA	DOB	DOPA	DOPB	Data RAM	Parity Ram
0	1	↑	↑	DIA	DIB	DIPA	DIPB	X	DIB	X	DIPB	DIB	DIPB
1	1	↑	↑	DIA	DIB	DIPA	DIPB	No Change	X	No Change	X	X	X

WRITE\_MODE\_A=READ\_FIRST and WRITE\_MODE\_B=WRITE\_FIRST

WEA	WEB	CLKA	CLKB	DIA	DIB	DIPA	DIPB	DOA	DOB	DOPA	DOPB	Data RAM	Parity Ram
0	0	↑	↑	DIA	DIB	DIPA	DIPB	RAM	RAM	RAM	RAM	No Change	No Change
1	0	↑	↑	DIA	DIB	DIPA	DIPB	RAM	RAM	RAM	RAM	DIA	DIPA
0	1	↑	↑	DIA	DIB	DIPA	DIPB	X	DIB	X	DIPB	DIB	DIPB
1	1	↑	↑	DIA	DIB	DIPA	DIPB	X	DIB	X	DIPB	DIA	DIPA

## Design Entry Method

This design element can be used in schematics.

## Available Attributes

Attribute	Type	Allowed Values	Default	Description
INIT_00 To INIT_3F	Binary/Hexadecimal	Any	All zeros	Specifies the initial contents of the data portion of the RAM array.
INIT_A	Binary/Hexadecimal	Any	All zeros	Identifies the initial value of the DOA/DOB output port after completing configuration. For Type, the bit width is dependent on the width of the A or B port of the RAM.
INIT_B	Binary/Hexadecimal	Any	All zeros	Identifies the initial value of the DOA/DOB output port after completing configuration. For Type, the bit width is dependent on the width of the A or B port of the RAM.
INITP_00 To INITP_07	Binary/Hexadecimal	Any	All zeros	Specifies the initial contents of the parity portion of the RAM array.
SIM_COLLISION_CHECK	String	"ALL", "NONE", "WARNING", or "GENERATE_X_ONLY"	"ALL"	Specifies the behavior during simulation in the event of a data collision (data being read or written to the same address from both ports of the Ram simultaneously. "ALL" issues a warning to simulator console and generate an X or all unknown data due to the collision. This is the recommended setting. "WARNING" generates a warning only and "GENERATE_X_ONLY" generates an X for unknown data but won't output the occurrence to the simulation console. "NONE" completely ignores the error. It is suggested to only change this attribute if you can ensure the data generated during a collision is discarded.

Attribute	Type	Allowed Values	Default	Description
SRVAL_A	Binary/Hexadecimal	Any	All zeros	Allows the individual selection of whether the DOA/DOB output port sets (go to a one) or reset (go to a zero) upon the assertion of the RSTA pin. For Type, the bit width is dependent on the width of the A port of the RAM.
SRVAL_B	Binary/Hexadecimal	Any	All zeros	Allows the individual selection of whether the DOA/DOB output port sets (go to a one) or reset (go to a zero) upon the assertion of the RSTB pin. For Type, the bit width is dependent on the width of the B port of the RAM.
WRITE_MODE_A	String	"WRITE_FIRST", "READ_FIRST" or "NO_CHANGE"	"WRITE_FIRST"	Specifies the behavior of the DOA/DOB port upon a write command to the respected port. If set to WRITE_FIRST, the same port that is written to displays the contents of the written data to the outputs upon completion of the operation. "READ_FIRST" displays the prior contents of the RAM to the output port prior to writing the new data. "NO_CHANGE" keeps the previous value on the output port and won't update the output port upon a write command. This is the suggested mode if not using the read data from a particular port of the RAM
WRITE_MODE_B	String	"WRITE_FIRST", "READ_FIRST" or "NO_CHANGE"	"WRITE_FIRST"	Specifies the behavior of the DOA/DOB port upon a write command to the respected port. If set to WRITE_FIRST, the same port that is written to displays the contents of the written data to the outputs upon completion of the operation. "READ_FIRST" displays the prior contents of the RAM to the output port prior to writing the new data. "NO_CHANGE" keeps the previous value on the output port and won't update the output port upon a write command. This is the suggested mode if not using the read data from a particular port of the RAM.

## For More Information

- See the [Spartan-3 User Guide](#).
- See the [Spartan-3 Data Sheets](#).

# RAMB16\_S9

Primitive: 16K-bit Data and 2K-bit Parity Single-Port Synchronous Block RAM with 9-bit Port

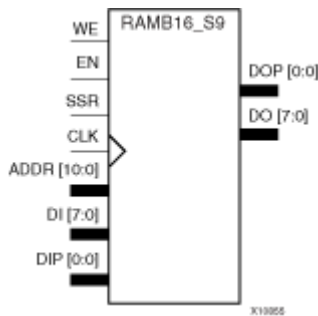

## Introduction

This design element is a dedicated random access memory blocks with synchronous write capability. The block RAM port has 16384 bits of data memory.

The enable ENA pin controls read, write, and reset for Port A. When ENA is Low, no data is written and the outputs (DOA and DOPA) retain the last state. When ENA is High and reset (SSRA) is High, DOA and DOPA are set to SRVAL\_A during the Low-to-High clock (CLKA) transition; if write enable (WEA) is High, the memory contents reflect the data at DIA and DIPA. When ENA is High and WEA is Low, the data stored in the RAM address (ADDRA) is read during the Low-to-High clock transition. By default, WRITE\_MODE\_A=WRITE\_FIRST, when ENA and WEA are High, the data on the data inputs (DIA and DIPA) is loaded into the word selected by the write address (ADDRA) during the Low-to-High clock transition and the data outputs (DOA and DOPA) reflect the selected (addressed) word.

The above description assumes an active High EN, WE, SSR, and CLK. However, the active level can be changed by placing an inverter on the port. Any inverter placed on a RAMB16 port is absorbed into the block and does not use a CLB resource.

The cell configuration for this element is listed in the following table.

	Data Cells		Parity Cells				
Component	Depth	Width	Depth	Width	Address Bus	Data Bus	Parity Bus
RAMB16_S9	2048	8	2048	1	(10:0)	(7:0)	(0:0)

## Design Entry Method

This design element can be used in schematics.

## Available Attributes

Attribute	Type	Allowed Values	Default	Description
INIT	Binary	Any Hex Value	All zeros	Identifies the initial value of the DO output port after completing configuration. The bit width is dependent on the width of the A or B port of the RAM.
INIT_00 - INIT_3F	Binary	Any Hex Value	All zeros	Specifies the initial contents of the data portion of the RAM array.
INITP_00 - INITP_07	Binary	Any Hex Value	All zeros	Specifies the initial contents of the parity portion of the RAM array.

Attribute	Type	Allowed Values	Default	Description
SRVAL	Binary	Any Hex Value	All zeros	Allows the individual selection of whether the DO output port sets (go to a one) or reset (go to a zero) upon the assertion of the SSR pin. The bit width is dependent on the width of the A or B port of the RAM.
WRITE_MODE	String	"WRITE_FIRST", "READ_FIRST" or "NO_CHANGE"	"WRITE_FIRST"	Specifies the behavior of the DO port upon a write command to the respected port. If set to "WRITE_FIRST", the same port that is written to displays the contents of the written data to the outputs upon completion of the operation. "READ_FIRST" displays the prior contents of the RAM to the output port prior to writing the new data. "NO_CHANGE" keeps the previous value on the output port and won't update the output port upon a write command. This is the suggested mode if not using the read data from a particular port of the RAM.

### For More Information

- See the [Spartan-3 User Guide](#).
- See the [Spartan-3 Data Sheets](#).

# RAMB16\_S9\_S18

Primitive: 16K-bit Data and 2K-bit Parity Dual-Port Synchronous Block RAM with 9-bit and 18-bit Ports

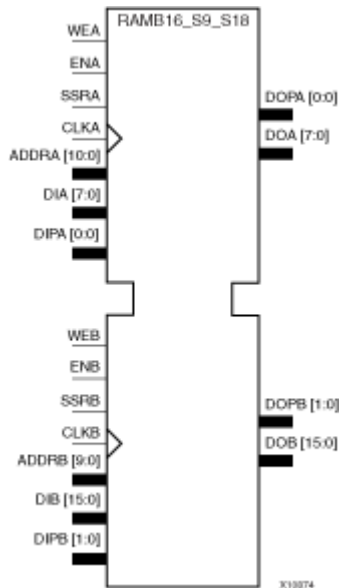

## Introduction

This design element is a dual-ported dedicated random access memory block with synchronous write capability. Each block RAM port has 16384 bits of data memory. Ports configured as 9, 18, or 36-bits wide have an additional 2048 bits of parity memory. Each port is independent of the other while accessing the same set of 16384 data memory cells. Each port is independently configured to a specific data width. The possible port and cell configurations for this element are listed under "Port Descriptions."

## Logic Table

Truth Table A

Inputs								Outputs			
GSR	ENA	SSRA	WEA	CLKA	ADDRA	DIA	DIPA	DOA	DOPA	RAM Contents	
										Data RAM	Parity RAM
1	X	X	X	X	X	X	X	INIT_A	INIT_A	No Change	No Change
0	0	X	X	X	X	X	X	No Change	No Change	No Change	No Change
0	1	1	0	↑	X	X	X	SRVAL_A	SRVAL_A	No Change	No Change
0	1	1	1	↑	addr	data	pdata	SRVAL_A	SRVAL_A	RAM(addr) =>data	RAM(addr) =>pdata
0	1	0	0	↑	addr	X	X	RAM(addr)	RAM(addr)	No Change	No Change

Inputs								Outputs			
GSR	ENA	SSRA	WEA	CLKA	ADDRA	DIA	DIPA	DOA	DOPA	RAM Contents	
										Data RAM	Parity RAM
0	1	0	1	↑	addr	data	pdata	No Change1, RAM (addr)2, data3	No Change1, RAM (addr)2, pdata3	RAM(addr) =>data	RAM(addr) =>pdata

GSR=Global Set Reset  
 INIT\_A=Value specified by the INIT\_A attribute for output register. Default is all zeros.  
 SRVAL\_A=register value.  
 addr=RAM address.  
 RAM(addr)=RAM contents at address ADDR.  
 data=RAM input data.  
 pdata=RAM parity data.  
 1WRITE\_MODE\_A=NO\_CHANGE.  
 2WRITE\_MODE\_A=READ\_FIRST.  
 3WRITE\_MODE\_A=WRITE\_FIRST.

Truth Table B

Inputs								Outputs			
GSR	ENB	SSRB	WEB	CLKB	ADDRB	DIB	DIPB	DOB	DOPB	RAM Contents	
										Data RAM	Parity RAM
1	X	X	X	X	X	X	X	INIT_B	INIT_B	No Change	No Change
0	0	X	X	X	X	X	X	No Change	No Change	No Change	No Change
0	1	1	0	↑	X	X	X	SRVAL_B	SRVAL_B	No Change	No Change
0	1	1	1	↑	addr	data	pdata	SRVAL_B	SRVAL_B	RAM(addr) =>data	RAM(addr) =>pdata
0	1	0	0	↑	addr	X	X	RAM(addr)	RAM(addr)	No Change	No Change
0	1	0	1	↑	addr	data	pdata	No Change1, RAM (addr)2, data3	No Change1, RAM (addr)2, pdata3	RAM(addr)2	RAM(addr) =>pdata

GSR=Global Set Reset.  
 INIT\_B=Value specified by the INIT\_B attribute for output registers. Default is all zeros.  
 SRVAL\_B=register value.  
 addr=RAM address.  
 RAM(addr)=RAM contents at address ADDR.  
 data=RAM input data.  
 pdata=RAM parity data.  
 1WRITE\_MODE\_B=NO\_CHANGE.  
 2WRITE\_MODE\_B=READ\_FIRST.  
 3WRITE\_MODE\_B=WRITE\_FIRST.

## Port Descriptions

Port A						Port B				
Component	Data Cells(a)	Parity Cells(a)	Address Bus	Data Bus	Parity Bus	Data Cells(a)	Parity Cells(a)	Address Bus	Data Bus	Parity Bus
RAMB16_S9_S18	2048 x 8	2048 x 1	(10:0)	(7:0)	(0:0)	1024 x 16	1024 x 2	(9:0)	(15:0)	(1:0)
(a) Depth x Width										

Each port is fully synchronous with independent clock pins. All Port A input pins have setup time referenced to the CLKA pin and its data output bus DOA has a clock-to-out time referenced to the CLKA. All Port B input pins have setup time referenced to the CLKB pin and its data output bus DOB has a clock-to-out time referenced to the CLKB. The enable ENA pin controls read, write, and reset for Port A. When ENA is Low, no data is written and the outputs (DOA and DOPA) retain the last state. When ENA is High and reset (SSRA) is High, DOA and DOPA are set to SRVAL\_A during the Low-to-High clock (CLKA) transition; if write enable (WEA) is High, the memory contents reflect the data at DIA and DIPA. When ENA is High and WEA is Low, the data stored in the RAM address (ADDRA) is read during the Low-to-High clock transition. By default, WRITE\_MODE\_A=WRITE\_FIRST, when ENA and WEA are High, the data on the data inputs (DIA and DIPA) is loaded into the word selected by the write address (ADDRA) during the Low-to-High clock transition and the data outputs (DOA and DOPA) reflect the selected (addressed) word.

The enable ENB pin controls read, write, and reset for Port B. When ENB is Low, no data is written and the outputs (DOB and DOPB) retain the last state. When ENB is High and reset (SSRB) is High, DOB and DOPB are set to SRVAL\_B during the Low-to-High clock (CLKB) transition; if write enable (WEB) is High, the memory contents reflect the data at DIB and DIPB. When ENB is High and WEB is Low, the data stored in the RAM address (ADDRB) is read during the Low-to-High clock transition. By default, WRITE\_MODE\_B=WRITE\_FIRST, when ENB and WEB are High, the data on the data inputs (DIB and IPB) are loaded into the word selected by the write address (ADDRB) during the Low-to-High clock transition and the data outputs (DOB and DOPB) reflect the selected (addressed) word. The above descriptions assume active High control pins (ENA, WEA, SSRA, CLKA, ENB, WEB, SSRB, and CLKB). However, the active level can be changed by placing an inverter on the port. Any inverter placed on a RAMB16 port is absorbed into the block and does not use a CLB resource.

### Address Mapping

Each port accesses the same set of 18432 memory cells using an addressing scheme that is dependent on the width of the port. For all port widths, 16384 memory cells are available for data as shown in the "Port Address Mapping for Data" table below. For 9-, 18-, and 36-bit wide ports, 2408 parity memory cells are also available as shown in "Port Address Mapping for Parity" table below. The physical RAM location that is addressed for a particular width is determined from the following formula.

$$\text{Start} = ((\text{ADDR port} + 1) * (\text{Widthport})) - 1$$

$$\text{End} = (\text{ADDRport}) * (\text{Widthport})$$

The following tables show address mapping for each port width.

### Port Address Mapping for Data

Data Width	Port Data Addresses
1	16384 <-- 31 30 29 28 27 26 25 24 23 22 21 20 19 18 17 16 15 14 13 12 11 10 9 8 7 6 5 4 3 2 1 0
2	8192 <-- 15 14 13 12 11 10 9 8 7 6 5 4 3 2 1 0
4	4096 <-- 7 6 5 4 3 2 1 0
8	2048 <-- 3 2 1 0
16	1024 <-- 1 0
32	512 <-- 0

### Port Address Mapping for Parity

Parity Width	Port Parity Addresses																
1	2048	<-----	3					2					1				0
2	1024	<-----	1										0				
4	512	<-----	0														

#### Initializing Memory Contents of a Dual-Port RAMB16

You can use the INIT\_xx attributes to specify an initialization value for the memory contents of a RAMB16 during device configuration. The initialization of each RAMB16\_Sm\_Sn is set by 64 initialization attributes (INIT\_00 through INIT\_3F) of 64 hex values for a total of 16384 bits.

You can use the INITP\_xx attributes to specify an initial value for the parity memory during device configuration or assertion. The initialization of the parity memory for ports configured for 9, 18, or 36 bits is set by 8 initialization attributes (INITP\_00 through INITP\_07) of 64 hex values for a total of 2048 bits.

If any INIT\_xx or INITP\_xx attribute is not specified, it is configured as zeros. Partial Strings are padded with zeros to the left.

#### Initializing the Output Register of a Dual-Port RAMB16

In Spartan-3A, each bit in an output register can be initialized at power on (when GSR is high) to either a 0 or 1. In addition, the initial state specified for power on can be different than the state that results from assertion of a set/reset. Four properties control initialization of the output register for a dual-port RAMB16: INIT\_A, INIT\_B, SRVAL\_A, and SRVAL\_B. The INIT\_A attribute specifies the output register value at power on for Port A and the INIT\_B attribute specifies the value for Port B. You can use the SRVAL\_A attribute to define the state resulting from assertion of the SSR (set/reset) input on Port A. You can use the SRVAL\_B attribute to define the state resulting from assertion of the SSR input on Port B.

The INIT\_A, INIT\_B, SRVAL\_A, and SRVAL\_B attributes specify the initialization value as a hexadecimal String. The value is dependent upon the port width. For example, for a RAMB16\_S1\_S4 with Port A width equal to 1 and Port B width equal to 4, the Port A output register contains 1 bit and the Port B output register contains 4 bits. Therefore, the INIT\_A or SRVAL\_A value can only be specified as a 1 or 0. For Port B, the output register contains 4 bits. In this case, you can use INIT\_B or SRVAL\_B to specify a hexadecimal value from 0 through F to initialize the 4 bits of the output register.

For those ports that include parity bits, the parity portion of the output register is specified in the high order bit position of the INIT\_A, INIT\_B, SRVAL\_A, or SRVAL\_B value.

The INIT and SRVAL attributes default to zero if they are not set by you.

#### Write Mode Selection

The WRITE\_MODE\_A attribute controls the memory and output contents of Port A for a dual-port RAMB16. The WRITE\_MODE\_B attribute does the same for Port B. By default, both WRITE\_MODE\_A and WRITE\_MODE\_B are set to WRITE\_FIRST. This means that input is read, written to memory, and then passed to output. You can set the write mode for Port A and Port B to READ\_FIRST to read the memory contents, pass the memory contents to the outputs, and then write the input to memory. Or, you can set the write mode to NO\_CHANGE to have the input written to memory without changing the output. The "Port A and Port B Conflict Resolution" section describes how read/write conflicts are resolved when both Port A and Port B are attempting to read/write to the same memory cells.

#### Port A and Port B Conflict Resolution

Spartan-3A block SelectRAM is True Dual-Port RAM that allows both ports to simultaneously access the same memory cell. When one port writes to a given memory cell, the other port must not address that memory cell (for a write or a read) within the clock-to-clock setup window.

The following tables summarize the collision detection behavior of the dual-port RAMB16 based on the WRITE\_MODE\_A and WRITE\_MODE\_B settings.

*WRITE\_MODE\_A=NO\_CHANGE and WRITE\_MODE\_B=NO\_CHANGE*



WEA	WEB	CLKA	CLKB	DIA	DIB	DIPA	DIPB	DOA	DOB	DOPA	DOPB	Data RAM	Parity Ram
0	0	↑	↑	DIA	DIB	DIPA	DIPB	RAM	RAM	RAM	RAM	No Change	No Change
1	0	↑	↑	DIA	DIB	DIPA	DIPB	No Change	X	No Change	X	DIA	DIPA
0	1	↑	↑	DIA	DIB	DIPA	DIPB	X	No Change	X	No Change	DIB	DIPB
1	1	↑	↑	DIA	DIB	DIPA	DIPB	No Change	No Change	No Change	No Change	X	X

WRITE\_MODE\_A=READ\_FIRST and WRITE\_MODE\_B=READ\_FIRST

WEA	WEB	CLKA	CLKB	DIA	DIB	DIPA	DIPB	DOA	DOB	DOPA	DOPB	Data RAM	Parity Ram
0	0	↑	↑	DIA	DIB	DIPA	DIPB	RAM	RAM	RAM	RAM	No Change	No Change
1	0	↑	↑	DIA	DIB	DIPA	DIPB	RAM	RAM	RAM	RAM	DIA	DIPA
0	1	↑	↑	DIA	DIB	DIPA	DIPB	RAM	RAM	RAM	RAM	DIB	DIPB
1	1	↑	↑	DIA	DIB	DIPA	DIPB	RAM	RAM	RAM	RAM	X	X

WRITE\_MODE\_A= WRITE\_FIRST and WRITE\_MODE\_B=WRITE\_FIRST

WEA	WEB	CLKA	CLKB	DIA	DIB	DIPA	DIPB	DOA	DOB	DOPA	DOPB	Data RAM	Parity Ram
0	0	↑	↑	DIA	DIB	DIPA	DIPB	RAM	RAM	RAM	RAM	No Change	No Change
1	0	↑	↑	DIA	DIB	DIPA	DIPB	DIA	X	DIPA	X	DIA	DIPA
0	1	↑	↑	DIA	DIB	DIPA	DIPB	X	DIB	X	DIPB	DIB	DIPB
1	1	↑	↑	DIA	DIB	DIPA	DIPB	X	X	X	X	X	X

WRITE\_MODE\_A=NO\_CHANGE and WRITE\_MODE\_B=READ\_FIRST

WEA	WEB	CLKA	CLKB	DIA	DIB	DIPA	DIPB	DOA	DOB	DOPA	DOPB	Data RAM	Parity Ram
0	0	↑	↑	DIA	DIB	DIPA	DIPB	RAM	RAM	RAM	RAM	No Change	No Change
1	0	↑	↑	DIA	DIB	DIPA	DIPB	No Change	X	No Change	X	DIA	DIPA
0	1	↑	↑	DIA	DIB	DIPA	DIPB	RAM	RAM	RAM	RAM	DIB	DIPB
1	1	↑	↑	DIA	DIB	DIPA	DIPB	No Change	X	No Change	X	DIB	DIPB

WRITE\_MODE\_A=NO\_CHANGE and WRITE\_MODE\_B=WRITE\_FIRST

WEA	WEB	CLKA	CLKB	DIA	DIB	DIPA	DIPB	DOA	DOB	DOPA	DOPB	Data RAM	Parity Ram
0	0	↑	↑	DIA	DIB	DIPA	DIPB	RAM	RAM	RAM	RAM	No Change	No Change
1	0	↑	↑	DIA	DIB	DIPA	DIPB	No Change	X	No Change	X	DIA	DIPA

WEA	WEB	CLKA	CLKB	DIA	DIB	DIPA	DIPB	DOA	DOB	DOPA	DOPB	Data RAM	Parity Ram
0	1	↑	↑	DIA	DIB	DIPA	DIPB	X	DIB	X	DIPB	DIB	DIPB
1	1	↑	↑	DIA	DIB	DIPA	DIPB	No Change	X	No Change	X	X	X

WRITE\_MODE\_A=READ\_FIRST and WRITE\_MODE\_B=WRITE\_FIRST

WEA	WEB	CLKA	CLKB	DIA	DIB	DIPA	DIPB	DOA	DOB	DOPA	DOPB	Data RAM	Parity Ram
0	0	↑	↑	DIA	DIB	DIPA	DIPB	RAM	RAM	RAM	RAM	No Change	No Change
1	0	↑	↑	DIA	DIB	DIPA	DIPB	RAM	RAM	RAM	RAM	DIA	DIPA
0	1	↑	↑	DIA	DIB	DIPA	DIPB	X	DIB	X	DIPB	DIB	DIPB
1	1	↑	↑	DIA	DIB	DIPA	DIPB	X	DIB	X	DIPB	DIA	DIPA

## Design Entry Method

This design element can be used in schematics.

## Available Attributes

Attribute	Type	Allowed Values	Default	Description
INIT_00 To INIT_3F	Binary/Hexadecimal	Any	All zeros	Specifies the initial contents of the data portion of the RAM array.
INIT_A	Binary/Hexadecimal	Any	All zeros	Identifies the initial value of the DOA/DOB output port after completing configuration. For Type, the bit width is dependent on the width of the A or B port of the RAM.
INIT_B	Binary/Hexadecimal	Any	All zeros	Identifies the initial value of the DOA/DOB output port after completing configuration. For Type, the bit width is dependent on the width of the A or B port of the RAM.
INITP_00 To INITP_07	Binary/Hexadecimal	Any	All zeros	Specifies the initial contents of the parity portion of the RAM array.
SIM_COLLISION_CHECK	String	"ALL", "NONE", "WARNING", or "GENERATE_X_ONLY"	"ALL"	Specifies the behavior during simulation in the event of a data collision (data being read or written to the same address from both ports of the Ram simultaneously. "ALL" issues a warning to simulator console and generate an X or all unknown data due to the collision. This is the recommended setting. "WARNING" generates a warning only and "GENERATE_X_ONLY" generates an X for unknown data but won't output the occurrence to the simulation console. "NONE" completely ignores the error. It is suggested to only change this attribute if you can ensure the data generated during a collision is discarded.

Attribute	Type	Allowed Values	Default	Description
SRVAL_A	Binary/Hexadecimal	Any	All zeros	Allows the individual selection of whether the DOA/DOB output port sets (go to a one) or reset (go to a zero) upon the assertion of the RSTA pin. For Type, the bit width is dependent on the width of the A port of the RAM.
SRVAL_B	Binary/Hexadecimal	Any	All zeros	Allows the individual selection of whether the DOA/DOB output port sets (go to a one) or reset (go to a zero) upon the assertion of the RSTB pin. For Type, the bit width is dependent on the width of the B port of the RAM.
WRITE_MODE_A	String	"WRITE_FIRST", "READ_FIRST" or "NO_CHANGE"	"WRITE_FIRST"	Specifies the behavior of the DOA/DOB port upon a write command to the respected port. If set to WRITE_FIRST, the same port that is written to displays the contents of the written data to the outputs upon completion of the operation. "READ_FIRST" displays the prior contents of the RAM to the output port prior to writing the new data. "NO_CHANGE" keeps the previous value on the output port and won't update the output port upon a write command. This is the suggested mode if not using the read data from a particular port of the RAM
WRITE_MODE_B	String	"WRITE_FIRST", "READ_FIRST" or "NO_CHANGE"	"WRITE_FIRST"	Specifies the behavior of the DOA/DOB port upon a write command to the respected port. If set to WRITE_FIRST, the same port that is written to displays the contents of the written data to the outputs upon completion of the operation. "READ_FIRST" displays the prior contents of the RAM to the output port prior to writing the new data. "NO_CHANGE" keeps the previous value on the output port and won't update the output port upon a write command. This is the suggested mode if not using the read data from a particular port of the RAM.

## For More Information

- See the [Spartan-3 User Guide](#).
- See the [Spartan-3 Data Sheets](#).

# RAMB16\_S9\_S36

Primitive: 16K-bit Data and 2K-bit Parity Dual-Port Synchronous Block RAM with 9-bit and 36-bit Ports

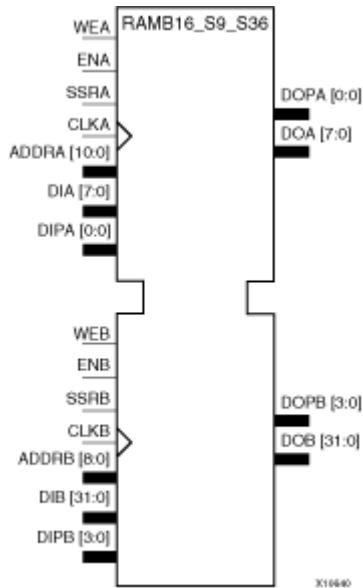

## Introduction

This design element is a dual-ported dedicated random access memory block with synchronous write capability. Each block RAM port has 16384 bits of data memory. Ports configured as 9, 18, or 36-bits wide have an additional 2048 bits of parity memory. Each port is independent of the other while accessing the same set of 16384 data memory cells. Each port is independently configured to a specific data width. The possible port and cell configurations for this element are listed under "Port Descriptions."

## Logic Table

Truth Table A

Inputs								Outputs			
GSR	ENA	SSRA	WEA	CLKA	ADDR_A	DIA	DIPA	DOA	DOPA	RAM Contents	
										Data RAM	Parity RAM
1	X	X	X	X	X	X	X	INIT_A	INIT_A	No Change	No Change
0	0	X	X	X	X	X	X	No Change	No Change	No Change	No Change
0	1	1	0	↑	X	X	X	SRVAL_A	SRVAL_A	No Change	No Change
0	1	1	1	↑	addr	data	pdata	SRVAL_A	SRVAL_A	RAM(addr) =>data	RAM(addr) =>pdata
0	1	0	0	↑	addr	X	X	RAM(addr)	RAM(addr)	No Change	No Change

Inputs								Outputs			
GSR	ENA	SSRA	WEA	CLKA	ADDRA	DIA	DIPA	DOA	DOPA	RAM Contents	
										Data RAM	Parity RAM
0	1	0	1	↑	addr	data	pdata	No Change1, RAM (addr)2, data3	No Change1, RAM (addr)2, pdata3	RAM(addr) =>data	RAM(addr) =>pdata

GSR=Global Set Reset  
 INIT\_A=Value specified by the INIT\_A attribute for output register. Default is all zeros.  
 SRVAL\_A=register value.  
 addr=RAM address.  
 RAM(addr)=RAM contents at address ADDR.  
 data=RAM input data.  
 pdata=RAM parity data.  
 1WRITE\_MODE\_A=NO\_CHANGE.  
 2WRITE\_MODE\_A=READ\_FIRST.  
 3WRITE\_MODE\_A=WRITE\_FIRST.

Truth Table B

Inputs								Outputs			
GSR	ENB	SSRB	WEB	CLKB	ADDRB	DIB	DIPB	DOB	DOPB	RAM Contents	
										Data RAM	Parity RAM
1	X	X	X	X	X	X	X	INIT_B	INIT_B	No Change	No Change
0	0	X	X	X	X	X	X	No Change	No Change	No Change	No Change
0	1	1	0	↑	X	X	X	SRVAL_B	SRVAL_B	No Change	No Change
0	1	1	1	↑	addr	data	pdata	SRVAL_B	SRVAL_B	RAM(addr) =>data	RAM(addr) =>pdata
0	1	0	0	↑	addr	X	X	RAM(addr)	RAM(addr)	No Change	No Change
0	1	0	1	↑	addr	data	pdata	No Change1, RAM (addr)2, data3	No Change1, RAM (addr)2, pdata3	RAM(addr)2	RAM(addr) =>pdata

GSR=Global Set Reset.  
 INIT\_B=Value specified by the INIT\_B attribute for output registers. Default is all zeros.  
 SRVAL\_B=register value.  
 addr=RAM address.  
 RAM(addr)=RAM contents at address ADDR.  
 data=RAM input data.  
 pdata=RAM parity data.  
 1WRITE\_MODE\_B=NO\_CHANGE.  
 2WRITE\_MODE\_B=READ\_FIRST.

See the ISE 10.1 User Guide for Schematic Designs

## Port Descriptions

Port A						Port B				
Design Element	Data Cells(a)	Parity Cells(a)	Address Bus	Data Bus	Parity Bus	Data Cells(a)	Parity Cells(a)	Address Bus	Data Bus	Parity Bus
RAMB16_S9_S36	2048 x 8	2048 x 1	(10:0)	(7:0)	(0:0)	512 x 32	512 x 4	(8:0)	(31:0)	(3:0)
(a)Depth x Width										

Each port is fully synchronous with independent clock pins. All Port A input pins have setup time referenced to the CLKA pin and its data output bus DOA has a clock-to-out time referenced to the CLKA. All Port B input pins have setup time referenced to the CLKB pin and its data output bus DOB has a clock-to-out time referenced to the CLKB. The enable ENA pin controls read, write, and reset for Port A. When ENA is Low, no data is written and the outputs (DOA and DOPA) retain the last state. When ENA is High and reset (SSRA) is High, DOA and DOPA are set to SRVAL\_A during the Low-to-High clock (CLKA) transition; if write enable (WEA) is High, the memory contents reflect the data at DIA and DIPA. When ENA is High and WEA is Low, the data stored in the RAM address (ADDRA) is read during the Low-to-High clock transition. By default, WRITE\_MODE\_A=WRITE\_FIRST, when ENA and WEA are High, the data on the data inputs (DIA and DIPA) is loaded into the word selected by the write address (ADDRA) during the Low-to-High clock transition and the data outputs (DOA and DOPA) reflect the selected (addressed) word.

The enable ENB pin controls read, write, and reset for Port B. When ENB is Low, no data is written and the outputs (DOB and DOPB) retain the last state. When ENB is High and reset (SSRB) is High, DOB and DOPB are set to SRVAL\_B during the Low-to-High clock (CLKB) transition; if write enable (WEB) is High, the memory contents reflect the data at DIB and DIPB. When ENB is High and WEB is Low, the data stored in the RAM address (ADDRB) is read during the Low-to-High clock transition. By default, WRITE\_MODE\_B=WRITE\_FIRST, when ENB and WEB are High, the data on the data inputs (DIB and DIPB) are loaded into the word selected by the write address (ADDRB) during the Low-to-High clock transition and the data outputs (DOB and DOPB) reflect the selected (addressed) word. The above descriptions assume active High control pins (ENA, WEA, SSRA, CLKA, ENB, WEB, SSRB, and CLKB). However, the active level can be changed by placing an inverter on the port. Any inverter placed on a RAMB16 port is absorbed into the block and does not use a CLB resource.

### Address Mapping

Each port accesses the same set of 18432 memory cells using an addressing scheme that is dependent on the width of the port. For all port widths, 16384 memory cells are available for data as shown in the "Port Address Mapping for Data" table below. For 9-, 18-, and 36-bit wide ports, 2408 parity memory cells are also available as shown in "Port Address Mapping for Parity" table below. The physical RAM location that is addressed for a particular width is determined from the following formula.

$$\text{Start} = ((\text{ADDR}_{\text{port}} + 1) * (\text{Width}_{\text{port}})) - 1$$

$$\text{End} = (\text{ADDR}_{\text{port}}) * (\text{Width}_{\text{port}})$$

The following tables shows address mapping for each port width.

### Port Address Mapping for Data

Data Width	Port Data Addresses																																				
1	16384	<--	31	30	29	28	27	26	25	24	23	22	21	20	19	18	17	16	15	14	13	12	11	10	9	8	7	6	5	4	3	2	1	0			
2	8192	<--	15		14		13		12		11		10		9		8		7		6		5		4		3		2		1		0				
4	4096	<--	7				6				5				4				3				2				1					0					
8	2048	<--	3								2								1								0										
16	1024	<--	1																0																		
32	512	<--	0																																		

### Port Address Mapping for Parity

Parity Width	Port Parity Addresses																
1	2048	<-----	3					2					1				0
2	1024	<-----	1										0				
4	512	<-----	0														

#### Initializing Memory Contents of a Dual-Port RAMB16

You can use the INIT\_xx attributes to specify an initialization value for the memory contents of a RAMB16 during device configuration. The initialization of each RAMB16\_Sm\_Sn is set by 64 initialization attributes (INIT\_00 through INIT\_3F) of 64 hex values for a total of 16384 bits.

You can use the INITP\_xx attributes to specify an initial value for the parity memory during device configuration or assertion. The initialization of the parity memory for ports configured for 9, 18, or 36 bits is set by 8 initialization attributes (INITP\_00 through INITP\_07) of 64 hex values for a total of 2048 bits.

If any INIT\_xx or INITP\_xx attribute is not specified, it is configured as zeros. Partial Strings are padded with zeros to the left.

#### Initializing the Output Register of a Dual-Port RAMB16

In Spartan-3A, each bit in an output register can be initialized at power on (when GSR is high) to either a 0 or 1. In addition, the initial state specified for power on can be different than the state that results from assertion of a set/reset. Four properties control initialization of the output register for a dual-port RAMB16: INIT\_A, INIT\_B, SRVAL\_A, and SRVAL\_B. The INIT\_A attribute specifies the output register value at power on for Port A and the INIT\_B attribute specifies the value for Port B. You can use the SRVAL\_A attribute to define the state resulting from assertion of the SSR (set/reset) input on Port A. You can use the SRVAL\_B attribute to define the state resulting from assertion of the SSR input on Port B.

The INIT\_A, INIT\_B, SRVAL\_A, and SRVAL\_B attributes specify the initialization value as a hexadecimal String. The value is dependent upon the port width. For example, for a RAMB16\_S1\_S4 with Port A width equal to 1 and Port B width equal to 4, the Port A output register contains 1 bit and the Port B output register contains 4 bits. Therefore, the INIT\_A or SRVAL\_A value can only be specified as a 1 or 0. For Port B, the output register contains 4 bits. In this case, you can use INIT\_B or SRVAL\_B to specify a hexadecimal value from 0 through F to initialize the 4 bits of the output register.

For those ports that include parity bits, the parity portion of the output register is specified in the high order bit position of the INIT\_A, INIT\_B, SRVAL\_A, or SRVAL\_B value.

The INIT and SRVAL attributes default to zero if they are not set by you.

#### Write Mode Selection

The WRITE\_MODE\_A attribute controls the memory and output contents of Port A for a dual-port RAMB16. The WRITE\_MODE\_B attribute does the same for Port B. By default, both WRITE\_MODE\_A and WRITE\_MODE\_B are set to WRITE\_FIRST. This means that input is read, written to memory, and then passed to output. You can set the write mode for Port A and Port B to READ\_FIRST to read the memory contents, pass the memory contents to the outputs, and then write the input to memory. Or, you can set the write mode to NO\_CHANGE to have the input written to memory without changing the output. The "Port A and Port B Conflict Resolution" section describes how read/write conflicts are resolved when both Port A and Port B are attempting to read/write to the same memory cells.

#### Port A and Port B Conflict Resolution

Spartan-3A block SelectRAM is True Dual-Port RAM that allows both ports to simultaneously access the same memory cell. When one port writes to a given memory cell, the other port must not address that memory cell (for a write or a read) within the clock-to-clock setup window.

The following tables summarize the collision detection behavior of the dual-port RAMB16 based on the WRITE\_MODE\_A and WRITE\_MODE\_B settings.

*WRITE\_MODE\_A=NO\_CHANGE and WRITE\_MODE\_B=NO\_CHANGE*

WEA	WEB	CLKA	CLKB	DIA	DIB	DIPA	DIPB	DOA	DOB	DOPA	DOPB	Data RAM	Parity Ram
0	0	↑	↑	DIA	DIB	DIPA	DIPB	RAM	RAM	RAM	RAM	No Change	No Change
1	0	↑	↑	DIA	DIB	DIPA	DIPB	No Change	X	No Change	X	DIA	DIPA
0	1	↑	↑	DIA	DIB	DIPA	DIPB	X	No Change	X	No Change	DIB	DIPB
1	1	↑	↑	DIA	DIB	DIPA	DIPB	No Change	No Change	No Change	No Change	X	X

*WRITE\_MODE\_A=READ\_FIRST and WRITE\_MODE\_B=READ\_FIRST*

WEA	WEB	CLKA	CLKB	DIA	DIB	DIPA	DIPB	DOA	DOB	DOPA	DOPB	Data RAM	Parity Ram
0	0	↑	↑	DIA	DIB	DIPA	DIPB	RAM	RAM	RAM	RAM	No Change	No Change
1	0	↑	↑	DIA	DIB	DIPA	DIPB	RAM	RAM	RAM	RAM	DIA	DIPA
0	1	↑	↑	DIA	DIB	DIPA	DIPB	RAM	RAM	RAM	RAM	DIB	DIPB
1	1	↑	↑	DIA	DIB	DIPA	DIPB	RAM	RAM	RAM	RAM	X	X

*WRITE\_MODE\_A=WRITE\_FIRST and WRITE\_MODE\_B=WRITE\_FIRST*

WEA	WEB	CLKA	CLKB	DIA	DIB	DIPA	DIPB	DOA	DOB	DOPA	DOPB	Data RAM	Parity Ram
0	0	↑	↑	DIA	DIB	DIPA	DIPB	RAM	RAM	RAM	RAM	No Change	No Change
1	0	↑	↑	DIA	DIB	DIPA	DIPB	DIA	X	DIPA	X	DIA	DIPA
0	1	↑	↑	DIA	DIB	DIPA	DIPB	X	DIB	X	DIPB	DIB	DIPB
1	1	↑	↑	DIA	DIB	DIPA	DIPB	X	X	X	X	X	X

*WRITE\_MODE\_A=NO\_CHANGE and WRITE\_MODE\_B=READ\_FIRST*

WEA	WEB	CLKA	CLKB	DIA	DIB	DIPA	DIPB	DOA	DOB	DOPA	DOPB	Data RAM	Parity Ram
0	0	↑	↑	DIA	DIB	DIPA	DIPB	RAM	RAM	RAM	RAM	No Change	No Change
1	0	↑	↑	DIA	DIB	DIPA	DIPB	No Change	X	No Change	X	DIA	DIPA
0	1	↑	↑	DIA	DIB	DIPA	DIPB	RAM	RAM	RAM	RAM	DIB	DIPB
1	1	↑	↑	DIA	DIB	DIPA	DIPB	No Change	X	No Change	X	DIB	DIPB

*WRITE\_MODE\_A=NO\_CHANGE and WRITE\_MODE\_B=WRITE\_FIRST*

WEA	WEB	CLKA	CLKB	DIA	DIB	DIPA	DIPB	DOA	DOB	DOPA	DOPB	Data RAM	Parity Ram
0	0	↑	↑	DIA	DIB	DIPA	DIPB	RAM	RAM	RAM	RAM	No Change	No Change
1	0	↑	↑	DIA	DIB	DIPA	DIPB	No Change	X	No Change	X	DIA	DIPA



WEA	WEB	CLKA	CLKB	DIA	DIB	DIPA	DIPB	DOA	DOB	DOPA	DOPB	Data RAM	Parity Ram
0	1	↑	↑	DIA	DIB	DIPA	DIPB	X	DIB	X	DIPB	DIB	DIPB
1	1	↑	↑	DIA	DIB	DIPA	DIPB	No Change	X	No Change	X	X	X

WRITE\_MODE\_A=READ\_FIRST and WRITE\_MODE\_B=WRITE\_FIRST

WEA	WEB	CLKA	CLKB	DIA	DIB	DIPA	DIPB	DOA	DOB	DOPA	DOPB	Data RAM	Parity Ram
0	0	↑	↑	DIA	DIB	DIPA	DIPB	RAM	RAM	RAM	RAM	No Change	No Change
1	0	↑	↑	DIA	DIB	DIPA	DIPB	RAM	RAM	RAM	RAM	DIA	DIPA
0	1	↑	↑	DIA	DIB	DIPA	DIPB	X	DIB	X	DIPB	DIB	DIPB
1	1	↑	↑	DIA	DIB	DIPA	DIPB	X	DIB	X	DIPB	DIA	DIPA

## Design Entry Method

This design element can be used in schematics.

## Available Attributes

Attribute	Type	Allowed Values	Default	Description
INIT_00 To INIT_3F	Binary/Hexadecimal	Any	All zeros	Specifies the initial contents of the data portion of the RAM array.
INIT_A	Binary/Hexadecimal	Any	All zeros	Identifies the initial value of the DOA/DOB output port after completing configuration. For Type, the bit width is dependent on the width of the A or B port of the RAM.
INIT_B	Binary/Hexadecimal	Any	All zeros	Identifies the initial value of the DOA/DOB output port after completing configuration. For Type, the bit width is dependent on the width of the A or B port of the RAM.
INITP_00 To INITP_07	Binary/Hexadecimal	Any	All zeros	Specifies the initial contents of the parity portion of the RAM array.
SIM_COLLISION_CHECK	String	"ALL", "NONE", "WARNING", or "GENERATE_X_ONLY"	"ALL"	Specifies the behavior during simulation in the event of a data collision (data being read or written to the same address from both ports of the Ram simultaneously. "ALL" issues a warning to simulator console and generate an X or all unknown data due to the collision. This is the recommended setting. "WARNING" generates a warning only and "GENERATE_X_ONLY" generates an X for unknown data but won't output the occurrence to the simulation console. "NONE" completely ignores the error. It is suggested to only change this attribute if you can ensure the data generated during a collision is discarded.

Attribute	Type	Allowed Values	Default	Description
SRVAL_A	Binary/Hexadecimal	Any	All zeros	Allows the individual selection of whether the DOA/DOB output port sets (go to a one) or reset (go to a zero) upon the assertion of the RSTA pin. For Type, the bit width is dependent on the width of the A port of the RAM.
SRVAL_B	Binary/Hexadecimal	Any	All zeros	Allows the individual selection of whether the DOA/DOB output port sets (go to a one) or reset (go to a zero) upon the assertion of the RSTB pin. For Type, the bit width is dependent on the width of the B port of the RAM.
WRITE_MODE_A	String	"WRITE_FIRST", "READ_FIRST" or "NO_CHANGE"	"WRITE_FIRST"	Specifies the behavior of the DOA/DOB port upon a write command to the respected port. If set to WRITE_FIRST, the same port that is written to displays the contents of the written data to the outputs upon completion of the operation. "READ_FIRST" displays the prior contents of the RAM to the output port prior to writing the new data. "NO_CHANGE" keeps the previous value on the output port and won't update the output port upon a write command. This is the suggested mode if not using the read data from a particular port of the RAM
WRITE_MODE_B	String	"WRITE_FIRST", "READ_FIRST" or "NO_CHANGE"	"WRITE_FIRST"	Specifies the behavior of the DOA/DOB port upon a write command to the respected port. If set to WRITE_FIRST, the same port that is written to displays the contents of the written data to the outputs upon completion of the operation. "READ_FIRST" displays the prior contents of the RAM to the output port prior to writing the new data. "NO_CHANGE" keeps the previous value on the output port and won't update the output port upon a write command. This is the suggested mode if not using the read data from a particular port of the RAM.

## For More Information

- See the [Spartan-3 User Guide](#).
- See the [Spartan-3 Data Sheets](#).

# RAMB16\_S9\_S9

Primitive: 16K-bit Data and 2K-bit Parity Dual-Port Synchronous Block RAM with 9-bit Ports

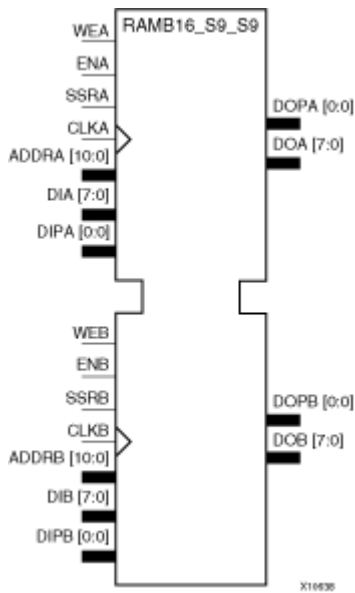

## Introduction

This design element is a dual-ported dedicated random access memory block with synchronous write capability. Each block RAM port has 16384 bits of data memory. Ports configured as 9, 18, or 36-bits wide have an additional 2048 bits of parity memory. Each port is independent of the other while accessing the same set of 16384 data memory cells. Each port is independently configured to a specific data width. The possible port and cell configurations for this element are listed under "Port Descriptions."

## Logic Table

Truth Table A

Inputs								Outputs			
GSR	ENA	SSRA	WEA	CLKA	ADDR_A	DIA	DIPA	DOA	DOPA	RAM Contents	
										Data RAM	Parity RAM
1	X	X	X	X	X	X	X	INIT_A	INIT_A	No Change	No Change
0	0	X	X	X	X	X	X	No Change	No Change	No Change	No Change
0	1	1	0	↑	X	X	X	SRVAL_A	SRVAL_A	No Change	No Change
0	1	1	1	↑	addr	data	pdata	SRVAL_A	SRVAL_A	RAM(addr) =>data	RAM(addr) =>pdata
0	1	0	0	↑	addr	X	X	RAM(addr)	RAM(addr)	No Change	No Change

Inputs								Outputs			
GSR	ENA	SSRA	WEA	CLKA	ADDRA	DIA	DIPA	DOA	DOPA	RAM Contents	
										Data RAM	Parity RAM
0	1	0	1	↑	addr	data	pdata	No Change1, RAM (addr)2, data3	No Change1, RAM (addr)2, pdata3	RAM(addr) =>data	RAM(addr) =>pdata

GSR=Global Set Reset  
 INIT\_A=Value specified by the INIT\_A attribute for output register. Default is all zeros.  
 SRVAL\_A=register value.  
 addr=RAM address.  
 RAM(addr)=RAM contents at address ADDR.  
 data=RAM input data.  
 pdata=RAM parity data.  
 1WRITE\_MODE\_A=NO\_CHANGE.  
 2WRITE\_MODE\_A=READ\_FIRST.  
 3WRITE\_MODE\_A=WRITE\_FIRST.

Truth Table B

Inputs								Outputs			
GSR	ENB	SSRB	WEB	CLKB	ADDRB	DIB	DIPB	DOB	DOPB	RAM Contents	
										Data RAM	Parity RAM
1	X	X	X	X	X	X	X	INIT_B	INIT_B	No Change	No Change
0	0	X	X	X	X	X	X	No Change	No Change	No Change	No Change
0	1	1	0	↑	X	X	X	SRVAL_B	SRVAL_B	No Change	No Change
0	1	1	1	↑	addr	data	pdata	SRVAL_B	SRVAL_B	RAM(addr) =>data	RAM(addr) =>pdata
0	1	0	0	↑	addr	X	X	RAM(addr)	RAM(addr)	No Change	No Change
0	1	0	1	↑	addr	data	pdata	No Change1, RAM (addr)2, data3	No Change1, RAM (addr)2, pdata3	RAM(addr)2	RAM(addr) =>pdata

GSR=Global Set Reset.  
 INIT\_B=Value specified by the INIT\_B attribute for output registers. Default is all zeros.  
 SRVAL\_B=register value.  
 addr=RAM address.  
 RAM(addr)=RAM contents at address ADDR.  
 data=RAM input data.  
 pdata=RAM parity data.  
 1WRITE\_MODE\_B=NO\_CHANGE.  
 2WRITE\_MODE\_B=READ\_FIRST.  
 3WRITE\_MODE\_B=WRITE\_FIRST.

## Port Descriptions

Port A						Port B				
Design Element	Data Cells(a)	Parity Cells(a)	Address Bus	Data Bus	Parity Bus	Data Cells(a)	Parity Cells(a)	Address Bus	Data Bus	Parity Bus
RAMB16_S9_S9	2048 x 8	2048 x 1	(10:0)	(7:0)	(0:0)	2048 x 8	2048 x 1	(10:0)	(7:0)	(0:0)
(a)Depth x Width										

Each port is fully synchronous with independent clock pins. All Port A input pins have setup time referenced to the CLKA pin and its data output bus DOA has a clock-to-out time referenced to the CLKA. All Port B input pins have setup time referenced to the CLKB pin and its data output bus DOB has a clock-to-out time referenced to the CLKB. The enable ENA pin controls read, write, and reset for Port A. When ENA is Low, no data is written and the outputs (DOA and DOPA) retain the last state. When ENA is High and reset (SSRA) is High, DOA and DOPA are set to SRVAL\_A during the Low-to-High clock (CLKA) transition; if write enable (WEA) is High, the memory contents reflect the data at DIA and DIP A. When ENA is High and WEA is Low, the data stored in the RAM address (ADDR A) is read during the Low-to-High clock transition. By default, WRITE\_MODE\_A=WRITE\_FIRST, when ENA and WEA are High, the data on the data inputs (DIA and DIP A) is loaded into the word selected by the write address (ADDR A) during the Low-to-High clock transition and the data outputs (DOA and DOPA) reflect the selected (addressed) word.

The enable ENB pin controls read, write, and reset for Port B. When ENB is Low, no data is written and the outputs (DOB and DOPB) retain the last state. When ENB is High and reset (SSRB) is High, DOB and DOPB are set to SRVAL\_B during the Low-to-High clock (CLKB) transition; if write enable (WEB) is High, the memory contents reflect the data at DIB and DIPB. When ENB is High and WEB is Low, the data stored in the RAM address (ADDRB) is read during the Low-to-High clock transition. By default, WRITE\_MODE\_B=WRITE\_FIRST, when ENB and WEB are High, the data on the data inputs (DIB and DIPB) are loaded into the word selected by the write address (ADDRB) during the Low-to-High clock transition and the data outputs (DOB and DOPB) reflect the selected (addressed) word. The above descriptions assume active High control pins (ENA, WEA, SSRA, CLKA, ENB, WEB, SSRB, and CLKB). However, the active level can be changed by placing an inverter on the port. Any inverter placed on a RAMB16 port is absorbed into the block and does not use a CLB resource.

### Address Mapping

Each port accesses the same set of 18432 memory cells using an addressing scheme that is dependent on the width of the port. For all port widths, 16384 memory cells are available for data as shown in the "Port Address Mapping for Data" table below. For 9-, 18-, and 36-bit wide ports, 2408 parity memory cells are also available as shown in "Port Address Mapping for Parity" table below. The physical RAM location that is addressed for a particular width is determined from the following formula.

$$\text{Start} = ((\text{ADDR port} + 1) * (\text{Widthport})) - 1$$

$$\text{End} = (\text{ADDRport}) * (\text{Widthport})$$

#### Port Address Mapping for Data

Data Width	Port Data Addresses
1	16384 <-- 31 30 29 28 27 26 25 24 23 22 21 20 19 18 17 16 15 14 13 12 11 10 9 8 7 6 5 4 3 2 1 0
2	8192 <-- 15 14 13 12 11 10 9 8 7 6 5 4 3 2 1 0
4	4096 <-- 7 6 5 4 3 2 1 0
8	2048 <-- 3 2 1 0
16	1024 <-- 1 0
32	512 <-- 0

#### Port Address Mapping for Parity

Parity Width	Port Parity Addresses															
1	2048	<-----	3				2					1				0
2	1024	<-----	1									0				
4	512	<-----	0													

#### Initializing Memory Contents of a Dual-Port RAMB16

You can use the INIT\_xx attributes to specify an initialization value for the memory contents of a RAMB16 during device configuration. The initialization of each RAMB16\_Sm\_Sn is set by 64 initialization attributes (INIT\_00 through INIT\_3F) of 64 hex values for a total of 16384 bits.

You can use the INITP\_xx attributes to specify an initial value for the parity memory during device configuration or assertion. The initialization of the parity memory for ports configured for 9, 18, or 36 bits is set by 8 initialization attributes (INITP\_00 through INITP\_07) of 64 hex values for a total of 2048 bits.

If any INIT\_xx or INITP\_xx attribute is not specified, it is configured as zeros. Partial Strings are padded with zeros to the left.

#### Initializing the Output Register of a Dual-Port RAMB16

In Spartan-3A, each bit in an output register can be initialized at power on (when GSR is high) to either a 0 or 1. In addition, the initial state specified for power on can be different than the state that results from assertion of a set/reset. Four properties control initialization of the output register for a dual-port RAMB16: INIT\_A, INIT\_B, SRVAL\_A, and SRVAL\_B. The INIT\_A attribute specifies the output register value at power on for Port A and the INIT\_B attribute specifies the value for Port B. You can use the SRVAL\_A attribute to define the state resulting from assertion of the SSR (set/reset) input on Port A. You can use the SRVAL\_B attribute to define the state resulting from assertion of the SSR input on Port B.

The INIT\_A, INIT\_B, SRVAL\_A, and SRVAL\_B attributes specify the initialization value as a hexadecimal String. The value is dependent upon the port width. For example, for a RAMB16\_S1\_S4 with Port A width equal to 1 and Port B width equal to 4, the Port A output register contains 1 bit and the Port B output register contains 4 bits. Therefore, the INIT\_A or SRVAL\_A value can only be specified as a 1 or 0. For Port B, the output register contains 4 bits. In this case, you can use INIT\_B or SRVAL\_B to specify a hexadecimal value from 0 through F to initialize the 4 bits of the output register.

For those ports that include parity bits, the parity portion of the output register is specified in the high order bit position of the INIT\_A, INIT\_B, SRVAL\_A, or SRVAL\_B value.

The INIT and SRVAL attributes default to zero if they are not set by you.

#### Write Mode Selection

The WRITE\_MODE\_A attribute controls the memory and output contents of Port A for a dual-port RAMB16. The WRITE\_MODE\_B attribute does the same for Port B. By default, both WRITE\_MODE\_A and WRITE\_MODE\_B are set to WRITE\_FIRST. This means that input is read, written to memory, and then passed to output. You can set the write mode for Port A and Port B to READ\_FIRST to read the memory contents, pass the memory contents to the outputs, and then write the input to memory. Or, you can set the write mode to NO\_CHANGE to have the input written to memory without changing the output. The "Port A and Port B Conflict Resolution" section describes how read/write conflicts are resolved when both Port A and Port B are attempting to read/write to the same memory cells.

#### Port A and Port B Conflict Resolution

Spartan-3A block SelectRAM is True Dual-Port RAM that allows both ports to simultaneously access the same memory cell. When one port writes to a given memory cell, the other port must not address that memory cell (for a write or a read) within the clock-to-clock setup window.

The following tables summarize the collision detection behavior of the dual-port RAMB16 based on the WRITE\_MODE\_A and WRITE\_MODE\_B settings.

WRITE\_MODE\_A=NO\_CHANGE and WRITE\_MODE\_B=NO\_CHANGE

WEA	WEB	CLKA	CLKB	DIA	DIB	DIPA	DIPB	DOA	DOB	DOPA	DOPB	Data RAM	Parity Ram
0	0	↑	↑	DIA	DIB	DIPA	DIPB	RAM	RAM	RAM	RAM	No Change	No Change
1	0	↑	↑	DIA	DIB	DIPA	DIPB	No Change	X	No Change	X	DIA	DIPA
0	1	↑	↑	DIA	DIB	DIPA	DIPB	X	No Change	X	No Change	DIB	DIPB
1	1	↑	↑	DIA	DIB	DIPA	DIPB	No Change	No Change	No Change	No Change	X	X

WRITE\_MODE\_A=READ\_FIRST and WRITE\_MODE\_B=READ\_FIRST

WEA	WEB	CLKA	CLKB	DIA	DIB	DIPA	DIPB	DOA	DOB	DOPA	DOPB	Data RAM	Parity Ram
0	0	↑	↑	DIA	DIB	DIPA	DIPB	RAM	RAM	RAM	RAM	No Change	No Change
1	0	↑	↑	DIA	DIB	DIPA	DIPB	RAM	RAM	RAM	RAM	DIA	DIPA
0	1	↑	↑	DIA	DIB	DIPA	DIPB	RAM	RAM	RAM	RAM	DIB	DIPB
1	1	↑	↑	DIA	DIB	DIPA	DIPB	RAM	RAM	RAM	RAM	X	X

WRITE\_MODE\_A= WRITE\_FIRST and WRITE\_MODE\_B=WRITE\_FIRST

WEA	WEB	CLKA	CLKB	DIA	DIB	DIPA	DIPB	DOA	DOB	DOPA	DOPB	Data RAM	Parity Ram
0	0	↑	↑	DIA	DIB	DIPA	DIPB	RAM	RAM	RAM	RAM	No Change	No Change
1	0	↑	↑	DIA	DIB	DIPA	DIPB	DIA	X	DIPA	X	DIA	DIPA
0	1	↑	↑	DIA	DIB	DIPA	DIPB	X	DIB	X	DIPB	DIB	DIPB
1	1	↑	↑	DIA	DIB	DIPA	DIPB	X	X	X	X	X	X

WRITE\_MODE\_A=NO\_CHANGE and WRITE\_MODE\_B=READ\_FIRST

WEA	WEB	CLKA	CLKB	DIA	DIB	DIPA	DIPB	DOA	DOB	DOPA	DOPB	Data RAM	Parity Ram
0	0	↑	↑	DIA	DIB	DIPA	DIPB	RAM	RAM	RAM	RAM	No Change	No Change
1	0	↑	↑	DIA	DIB	DIPA	DIPB	No Change	X	No Change	X	DIA	DIPA
0	1	↑	↑	DIA	DIB	DIPA	DIPB	RAM	RAM	RAM	RAM	DIB	DIPB
1	1	↑	↑	DIA	DIB	DIPA	DIPB	No Change	X	No Change	X	DIB	DIPB

WRITE\_MODE\_A=NO\_CHANGE and WRITE\_MODE\_B=WRITE\_FIRST

WEA	WEB	CLKA	CLKB	DIA	DIB	DIPA	DIPB	DOA	DOB	DOPA	DOPB	Data RAM	Parity Ram
0	0	↑	↑	DIA	DIB	DIPA	DIPB	RAM	RAM	RAM	RAM	No Change	No Change
1	0	↑	↑	DIA	DIB	DIPA	DIPB	No Change	X	No Change	X	DIA	DIPA

WEA	WEB	CLKA	CLKB	DIA	DIB	DIPA	DIPB	DOA	DOB	DOPA	DOPB	Data RAM	Parity Ram
0	1	↑	↑	DIA	DIB	DIPA	DIPB	X	DIB	X	DIPB	DIB	DIPB
1	1	↑	↑	DIA	DIB	DIPA	DIPB	No Change	X	No Change	X	X	X

WRITE\_MODE\_A=READ\_FIRST and WRITE\_MODE\_B=WRITE\_FIRST

WEA	WEB	CLKA	CLKB	DIA	DIB	DIPA	DIPB	DOA	DOB	DOPA	DOPB	Data RAM	Parity Ram
0	0	↑	↑	DIA	DIB	DIPA	DIPB	RAM	RAM	RAM	RAM	No Change	No Change
1	0	↑	↑	DIA	DIB	DIPA	DIPB	RAM	RAM	RAM	RAM	DIA	DIPA
0	1	↑	↑	DIA	DIB	DIPA	DIPB	X	DIB	X	DIPB	DIB	DIPB
1	1	↑	↑	DIA	DIB	DIPA	DIPB	X	DIB	X	DIPB	DIA	DIPA

## Design Entry Method

This design element can be used in schematics.

## Available Attributes

Attribute	Type	Allowed Values	Default	Description
INIT_00 To INIT_3F	Binary/Hexadecimal	Any	All zeros	Specifies the initial contents of the data portion of the RAM array.
INIT_A	Binary/Hexadecimal	Any	All zeros	Identifies the initial value of the DOA/DOB output port after completing configuration. For Type, the bit width is dependent on the width of the A or B port of the RAM.
INIT_B	Binary/Hexadecimal	Any	All zeros	Identifies the initial value of the DOA/DOB output port after completing configuration. For Type, the bit width is dependent on the width of the A or B port of the RAM.
INITP_00 To INITP_07	Binary/Hexadecimal	Any	All zeros	Specifies the initial contents of the parity portion of the RAM array.
SIM_COLLISION_CHECK	String	"ALL", "NONE", "WARNING", or "GENERATE_X_ONLY"	"ALL"	Specifies the behavior during simulation in the event of a data collision (data being read or written to the same address from both ports of the Ram simultaneously. "ALL" issues a warning to simulator console and generate an X or all unknown data due to the collision. This is the recommended setting. "WARNING" generates a warning only and "GENERATE_X_ONLY" generates an X for unknown data but won't output the occurrence to the simulation console. "NONE" completely ignores the error. It is suggested to only change this attribute if you can ensure the data generated during a collision is discarded.



Attribute	Type	Allowed Values	Default	Description
SRVAL_A	Binary/Hexadecimal	Any	All zeros	Allows the individual selection of whether the DOA/DOB output port sets (go to a one) or reset (go to a zero) upon the assertion of the RSTA pin. For Type, the bit width is dependent on the width of the A port of the RAM.
SRVAL_B	Binary/Hexadecimal	Any	All zeros	Allows the individual selection of whether the DOA/DOB output port sets (go to a one) or reset (go to a zero) upon the assertion of the RSTB pin. For Type, the bit width is dependent on the width of the B port of the RAM.
WRITE_MODE_A	String	"WRITE_FIRST", "READ_FIRST" or "NO_CHANGE"	"WRITE_FIRST"	Specifies the behavior of the DOA/DOB port upon a write command to the respected port. If set to WRITE_FIRST, the same port that is written to displays the contents of the written data to the outputs upon completion of the operation. "READ_FIRST" displays the prior contents of the RAM to the output port prior to writing the new data. "NO_CHANGE" keeps the previous value on the output port and won't update the output port upon a write command. This is the suggested mode if not using the read data from a particular port of the RAM
WRITE_MODE_B	String	"WRITE_FIRST", "READ_FIRST" or "NO_CHANGE"	"WRITE_FIRST"	Specifies the behavior of the DOA/DOB port upon a write command to the respected port. If set to WRITE_FIRST, the same port that is written to displays the contents of the written data to the outputs upon completion of the operation. "READ_FIRST" displays the prior contents of the RAM to the output port prior to writing the new data. "NO_CHANGE" keeps the previous value on the output port and won't update the output port upon a write command. This is the suggested mode if not using the read data from a particular port of the RAM.

## For More Information

- See the [Spartan-3 User Guide](#).
- See the [Spartan-3 Data Sheets](#).

## ROM128X1

Primitive: 128-Deep by 1-Wide ROM

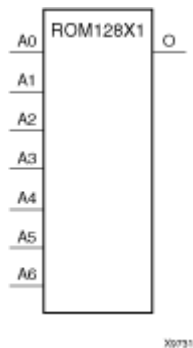

### Introduction

This design element is a 128-word by 1-bit read-only memory. The data output (O) reflects the word selected by the 7-bit address (A6 – A0). The ROM is initialized to a known value during configuration with the INIT=value parameter. The value consists of 32 hexadecimal digits that are written into the ROM from the most-significant digit A=FH to the least-significant digit A=0H. An error occurs if the INIT=value is not specified.

### Logic Table

Input				Output
I0	I1	I2	I3	O
0	0	0	0	INIT(0)
0	0	0	1	INIT(1)
0	0	1	0	INIT(2)
0	0	1	1	INIT(3)
0	1	0	0	INIT(4)
0	1	0	1	INIT(5)
0	1	1	0	INIT(6)
0	1	1	1	INIT(7)
1	0	0	0	INIT(8)
1	0	0	1	INIT(9)
1	0	1	0	INIT(10)
1	0	1	1	INIT(11)
1	1	0	0	INIT(12)
1	1	0	1	INIT(13)
1	1	1	0	INIT(14)
1	1	1	1	INIT(15)

### Design Entry Method

This design element can be used in schematics.

## Available Attributes

Attribute	Type	Allowed Values	Default	Description
INIT	Hexadecimal	Any 128-Bit Value	All zeros	Specifies the contents of the ROM.

## For More Information

- See the [Spartan-3 User Guide](#).
- See the [Spartan-3 Data Sheets](#).

## ROM16X1

Primitive: 16-Deep by 1-Wide ROM

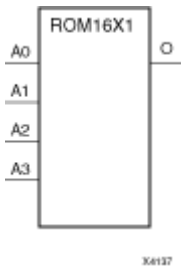

### Introduction

This design element is a 16-word by 1-bit read-only memory. The data output (O) reflects the word selected by the 4-bit address (A3 – A0). The ROM is initialized to a known value during configuration with the INIT=value parameter. The value consists of four hexadecimal digits that are written into the ROM from the most-significant digit A=FH to the least-significant digit A=0H. For example, the INIT=10A7 parameter produces the data stream: 0001 0000 1010 0111. An error occurs if the INIT=value is not specified.

### Logic Table

Input				Output
I0	I1	I2	I3	O
0	0	0	0	INIT(0)
0	0	0	1	INIT(1)
0	0	1	0	INIT(2)
0	0	1	1	INIT(3)
0	1	0	0	INIT(4)
0	1	0	1	INIT(5)
0	1	1	0	INIT(6)
0	1	1	1	INIT(7)
1	0	0	0	INIT(8)
1	0	0	1	INIT(9)
1	0	1	0	INIT(10)
1	0	1	1	INIT(11)
1	1	0	0	INIT(12)
1	1	0	1	INIT(13)
1	1	1	0	INIT(14)
1	1	1	1	INIT(15)

### Design Entry Method

This design element can be used in schematics.

## Available Attributes

Attribute	Type	Allowed Values	Default	Description
INIT	Hexadecimal	Any 16-Bit Value	All zeros	Specifies the contents of the ROM.

## For More Information

- See the [Spartan-3 User Guide](#).
- See the [Spartan-3 Data Sheets](#).

## ROM256X1

Primitive: 256-Deep by 1-Wide ROM

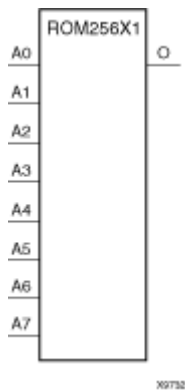

### Introduction

This design element is a 256-word by 1-bit read-only memory. The data output (O) reflects the word selected by the 8-bit address (A7– A0). The ROM is initialized to a known value during configuration with the INIT=value parameter. The value consists of 64 hexadecimal digits that are written into the ROM from the most-significant digit A=FH to the least-significant digit A=0H.

An error occurs if the INIT=value is not specified.

### Logic Table

Input				Output
I0	I1	I2	I3	O
0	0	0	0	INIT(0)
0	0	0	1	INIT(1)
0	0	1	0	INIT(2)
0	0	1	1	INIT(3)
0	1	0	0	INIT(4)
0	1	0	1	INIT(5)
0	1	1	0	INIT(6)
0	1	1	1	INIT(7)
1	0	0	0	INIT(8)
1	0	0	1	INIT(9)
1	0	1	0	INIT(10)
1	0	1	1	INIT(11)
1	1	0	0	INIT(12)
1	1	0	1	INIT(13)
1	1	1	0	INIT(14)
1	1	1	1	INIT(15)

## Design Entry Method

This design element can be used in schematics.

## Available Attributes

Attribute	Type	Allowed Values	Default	Description
INIT	Hexadecimal	Any 256-Bit Value	All zeros	Specifies the contents of the ROM.

## For More Information

- See the [Spartan-3 User Guide](#).
- See the [Spartan-3 Data Sheets](#).

## ROM32X1

Primitive: 32-Deep by 1-Wide ROM

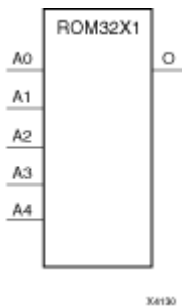

### Introduction

This design element is a 32-word by 1-bit read-only memory. The data output (O) reflects the word selected by the 5-bit address (A4 – A0). The ROM is initialized to a known value during configuration with the INIT=value parameter. The value consists of eight hexadecimal digits that are written into the ROM from the most-significant digit A=1FH to the least-significant digit A=00H.

For example, the INIT=10A78F39 parameter produces the data stream: 0001 0000 1010 0111 1000 1111 0011 1001. An error occurs if the INIT=value is not specified.

### Logic Table

Input				Output
I0	I1	I2	I3	O
0	0	0	0	INIT(0)
0	0	0	1	INIT(1)
0	0	1	0	INIT(2)
0	0	1	1	INIT(3)
0	1	0	0	INIT(4)
0	1	0	1	INIT(5)
0	1	1	0	INIT(6)
0	1	1	1	INIT(7)
1	0	0	0	INIT(8)
1	0	0	1	INIT(9)
1	0	1	0	INIT(10)
1	0	1	1	INIT(11)
1	1	0	0	INIT(12)
1	1	0	1	INIT(13)
1	1	1	0	INIT(14)
1	1	1	1	INIT(15)

### Design Entry Method

This design element can be used in schematics.



## Available Attributes

Attribute	Type	Allowed Values	Default	Description
INIT	Hexadecimal	Any 32-Bit Value	All zeros	Specifies the contents of the ROM.

## For More Information

- See the [Spartan-3 User Guide](#).
- See the [Spartan-3 Data Sheets](#).

## ROM64X1

Primitive: 64-Deep by 1-Wide ROM

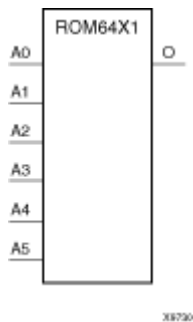

### Introduction

This design element is a 64-word by 1-bit read-only memory. The data output (O) reflects the word selected by the 6-bit address (A5 – A0). The ROM is initialized to a known value during configuration with the INIT=value parameter. The value consists of 16 hexadecimal digits that are written into the ROM from the most-significant digit A=FH to the least-significant digit A=0H. An error occurs if the INIT=value is not specified.

### Logic Table

Input				Output
I0	I1	I2	I3	O
0	0	0	0	INIT(0)
0	0	0	1	INIT(1)
0	0	1	0	INIT(2)
0	0	1	1	INIT(3)
0	1	0	0	INIT(4)
0	1	0	1	INIT(5)
0	1	1	0	INIT(6)
0	1	1	1	INIT(7)
1	0	0	0	INIT(8)
1	0	0	1	INIT(9)
1	0	1	0	INIT(10)
1	0	1	1	INIT(11)
1	1	0	0	INIT(12)
1	1	0	1	INIT(13)
1	1	1	0	INIT(14)
1	1	1	1	INIT(15)

### Design Entry Method

This design element can be used in schematics.

## Available Attributes

Attribute	Type	Allowed Values	Default	Description
INIT	Hexadecimal	Any 64-Bit Value	All zeros	Specifies the contents of the ROM.

## For More Information

- See the [Spartan-3 User Guide](#).
- See the [Spartan-3 Data Sheets](#).

## SOP3

Macro: Sum of Products

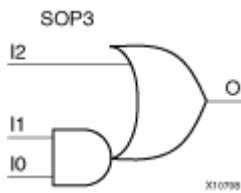

### Introduction

Three input Sum of Products (SOP) macros provide common logic functions by OR gating the output of one AND function with one direct input. Variations of inverting and non-inverting inputs are available.

### Design Entry Method

This design element is only for use in schematics.

### For More Information

- See the [Spartan-3 User Guide](#).
- See the [Spartan-3 Data Sheets](#).

## SOP3B1A

Macro: Sum of Products

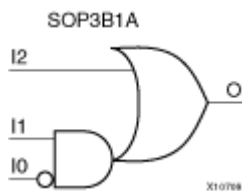

### Introduction

Three input Sum of Products (SOP) macros provide common logic functions by OR gating the output of one AND function with one direct input. Variations of inverting and non-inverting inputs are available.

### Design Entry Method

This design element is only for use in schematics.

### For More Information

- See the [Spartan-3 User Guide](#).
- See the [Spartan-3 Data Sheets](#).

## SOP3B1B

Macro: Sum of Products

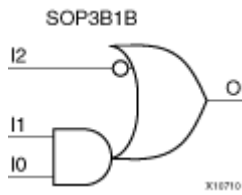

### Introduction

Three input Sum of Products (SOP) macros provide common logic functions by OR gating the output of one AND function with one direct input. Variations of inverting and non-inverting inputs are available.

### Design Entry Method

This design element is only for use in schematics.

### For More Information

- See the [Spartan-3 User Guide](#).
- See the [Spartan-3 Data Sheets](#).

## SOP3B2A

Macro: Sum of Products

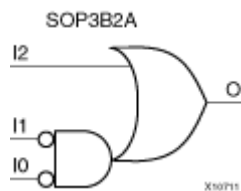

### Introduction

Three input Sum of Products (SOP) macros provide common logic functions by OR gating the output of one AND function with one direct input. Variations of inverting and non-inverting inputs are available.

### Design Entry Method

This design element is only for use in schematics.

### For More Information

- See the [Spartan-3 User Guide](#).
- See the [Spartan-3 Data Sheets](#).

## SOP3B2B

Macro: Sum of Products

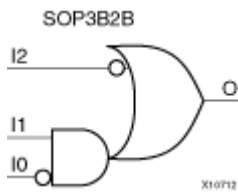

### Introduction

Three input Sum of Products (SOP) macros provide common logic functions by OR gating the output of one AND function with one direct input. Variations of inverting and non-inverting inputs are available.

### Design Entry Method

This design element is only for use in schematics.

### For More Information

- See the [Spartan-3 User Guide](#).
- See the [Spartan-3 Data Sheets](#).



## SOP3B3

Macro: Sum of Products

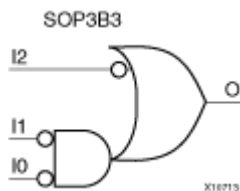

### Introduction

Three input Sum of Products (SOP) macros provide common logic functions by OR gating the output of one AND function with one direct input. Variations of inverting and non-inverting inputs are available.

### Design Entry Method

This design element is only for use in schematics.

### For More Information

- See the [Spartan-3 User Guide](#).
- See the [Spartan-3 Data Sheets](#).

## SOP4

Macro: Sum of Products

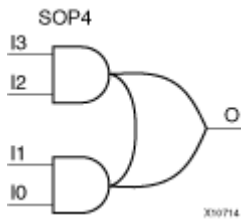

### Introduction

Four input Sum of Products (SOP) macros provide common logic functions by OR gating the outputs of two AND functions. Variations of inverting and non-inverting inputs are available.

### Design Entry Method

This design element is only for use in schematics.

### For More Information

- See the [Spartan-3 User Guide](#).
- See the [Spartan-3 Data Sheets](#).

## SOP4B1

Macro: Sum of Products

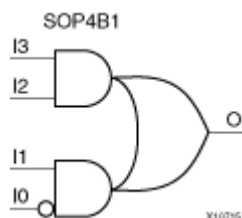

### Introduction

Four input Sum of Products (SOP) macros provide common logic functions by OR gating the outputs of two AND functions. Variations of inverting and non-inverting inputs are available.

### Design Entry Method

This design element is only for use in schematics.

### For More Information

- See the [Spartan-3 User Guide](#).
- See the [Spartan-3 Data Sheets](#).

## SOP4B2A

Macro: Sum of Products

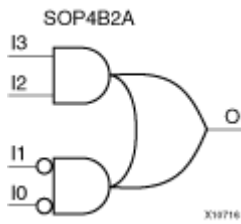

### Introduction

Four input Sum of Products (SOP) macros provide common logic functions by OR gating the outputs of two AND functions. Variations of inverting and non-inverting inputs are available.

### Design Entry Method

This design element is only for use in schematics.

### For More Information

- See the [Spartan-3 User Guide](#).
- See the [Spartan-3 Data Sheets](#).

## SOP4B2B

Macro: Sum of Products

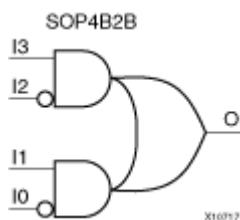

### Introduction

Four input Sum of Products (SOP) macros provide common logic functions by OR gating the outputs of two AND functions. Variations of inverting and non-inverting inputs are available.

### Design Entry Method

This design element is only for use in schematics.

### For More Information

- See the [Spartan-3 User Guide](#).
- See the [Spartan-3 Data Sheets](#).

## SOP4B3

Macro: Sum of Products

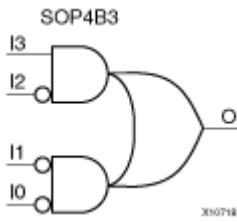

### Introduction

Four input Sum of Products (SOP) macros provide common logic functions by OR gating the outputs of two AND functions. Variations of inverting and non-inverting inputs are available.

### Design Entry Method

This design element is only for use in schematics.

### For More Information

- See the [Spartan-3 User Guide](#).
- See the [Spartan-3 Data Sheets](#).

## SOP4B4

Macro: Sum of Products

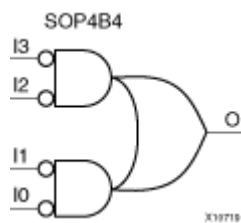

### Introduction

Four input Sum of Products (SOP) macros provide common logic functions by OR gating the outputs of two AND functions. Variations of inverting and non-inverting inputs are available.

### Design Entry Method

This design element is only for use in schematics.

### For More Information

- See the [Spartan-3 User Guide](#).
- See the [Spartan-3 Data Sheets](#).

## SR16CE

Macro: 16-Bit Serial-In Parallel-Out Shift Register with Clock Enable and Asynchronous Clear

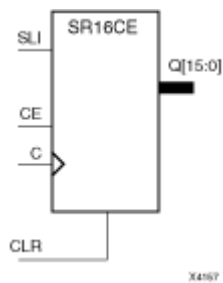

### Introduction

This design element is a shift register with a shift-left serial input (SLI), parallel outputs (Q), and clock enable (CE) and asynchronous clear (CLR) inputs. The (CLR) input, when High, overrides all other inputs and resets the data outputs (Q) Low. When (CE) is High and (CLR) is Low, the data on the SLI input is loaded into the first bit of the shift register during the Low-to-High clock (C) transition and appears on the (Q0) output. During subsequent Low-to-High clock transitions, when (CE) is High and (CLR) is Low, data shifts to the next highest bit position as new data is loaded into (Q0) (SLI→Q0, Q0→Q1, Q1→Q2, and so forth). The register ignores clock transitions when (CE) is Low.

Registers can be cascaded by connecting the last (Q) output of one stage to the SLI input of the next stage and connecting clock, (CE), and (CLR) in parallel.

This register is asynchronously cleared, outputs Low, when power is applied. For FPGA devices, power-on conditions are simulated when global set/reset (GSR) is active. GSR defaults to active-High but can be inverted by adding an inverter in front of the GSR input of the appropriate `STARTUP_architecture` symbol.

### Logic Table

Inputs				Outputs	
CLR	CE	SLI	C	Q0	Qz - Q1
1	X	X	X	0	0
0	0	X	X	No Change	No Change
0	1	SLI	↑	SLI	qn-1

z = bit width - 1  
qn-1 = state of referenced output one setup time prior to active clock transition

### Design Entry Method

This design element is only for use in schematics.

### For More Information

- See the [Spartan-3 User Guide](#).
- See the [Spartan-3 Data Sheets](#).



## SR16CLE

Macro: 16-Bit Loadable Serial/Parallel-In Parallel-Out Shift Register with Clock Enable and Asynchronous Clear

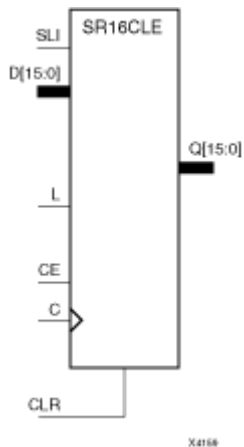

### Introduction

This design element is a shift register with a shift-left serial input (SLI), parallel inputs (D), parallel outputs (Q), and three control inputs: clock enable (CE), load enable (L), and asynchronous clear (CLR). The register ignores clock transitions when (L) and (CE) are Low. The asynchronous (CLR), when High, overrides all other inputs and resets the data outputs (Q) Low. When (L) is High and (CLR) is Low, data on the  $D_n - D_0$  inputs is loaded into the corresponding  $Q_n - (Q_0)$  bits of the register.

When (CE) is High and (L) and (CLR) are Low, data on the SLI input is loaded into the first bit of the shift register during the Low-to-High clock (C) transition and appears on the (Q0) output. During subsequent clock transitions, when (CE) is High and (L) and (CLR) are Low, the data shifts to the next highest bit position as new data is loaded into (Q)0 (for example,  $SLI \rightarrow Q_0$ ,  $Q_0 \rightarrow Q_1$ , and  $Q_1 \rightarrow Q_2$ ).

Registers can be cascaded by connecting the last (Q) output of one stage to the SLI input of the next stage and connecting clock, (CE), (L), and (CLR) inputs in parallel.

This register is asynchronously cleared, outputs Low, when power is applied. For FPGA devices, power-on conditions are simulated when global set/reset (GSR) is active. GSR defaults to active-High but can be inverted by adding an inverter in front of the GSR input of the appropriate `STARTUP_architecture` symbol.

### Logic Table

Inputs						Outputs	
CLR	L	CE	SLI	$D_n - D_0$	C	Q0	$Q_z - Q_1$
1	X	X	X	X	X	0	0
0	1	X	X	$D_n - D_0$	↑	D0	$D_n$
0	0	1	SLI	X	↑	SLI	$q_{n-1}$
0	0	0	X	X	X	No Change	No Change

$z = \text{bitwidth} - 1$

$q_{n-1}$  = state of referenced output one setup time prior to active clock transition

### Design Entry Method

This design element is only for use in schematics.

## For More Information

- See the [Spartan-3 User Guide](#).
- See the [Spartan-3 Data Sheets](#).

## SR16CLED

Macro: 16-Bit Shift Register with Clock Enable and Asynchronous Clear

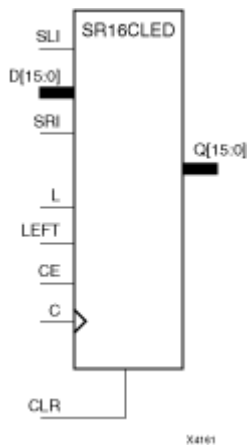

### Introduction

This design element is a shift register with shift-left (SLI) and shift-right (SRI) serial inputs, parallel inputs (D), parallel outputs (Q), and four control inputs: clock enable (CE), load enable (L), shift left/right (LEFT), and asynchronous clear (CLR). The register ignores clock transitions when (CE) and (L) are Low. The asynchronous clear, when High, overrides all other inputs and resets the data outputs (Qn) Low.

When (L) is High and (CLR) is Low, the data on the (D) inputs is loaded into the corresponding (Q) bits of the register. When (CE) is High and (L) and (CLR) are Low, data is shifted right or left, depending on the state of the LEFT input. If LEFT is High, data on the SLI is loaded into (Q0) during the Low-to-High clock transition and shifted left (for example, to Q1 or Q2) during subsequent clock transitions. If LEFT is Low, data on the SRI is loaded into the last (Q) output during the Low-to-High clock transition and shifted right during subsequent clock transitions. The logic tables indicate the state of the (Q) outputs under all input conditions.

This register is asynchronously cleared, outputs Low, when power is applied. For FPGA devices, power-on conditions are simulated when global set/reset (GSR) is active. GSR defaults to active-High but can be inverted by adding an inverter in front of the GSR input of the appropriate STARTUP\_architecture symbol.

### Logic Table

Inputs								Outputs		
CLR	L	CE	LEFT	SLI	SRI	D15 – D0	C	Q0	Q15	Q14 – Q1
1	X	X	X	X	X	X	X	0	0	0
0	1	X	X	X	X	D15 – D0	↑	D0	D15	Dn
0	0	0	X	X	X	X	X	No Change	No Change	No Change
0	0	1	1	SLI	X	X	↑	SLI	q14	qn-1
0	0	1	0	X	SRI	X	↑	q1	SRI	qn+1

qn-1 or qn+1 = state of referenced output one setup time prior to active clock transition.

### Design Entry Method

This design element is only for use in schematics.

## For More Information

- See the [Spartan-3 User Guide](#).
- See the [Spartan-3 Data Sheets](#).

## SR16RE

Macro: 16-Bit Serial-In Parallel-Out Shift Register with Clock Enable and Synchronous Reset

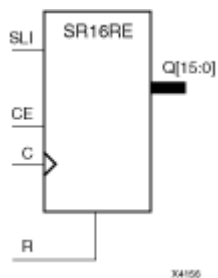

### Introduction

This design element is a shift register with shift-left serial input (SLI), parallel outputs (Qn), clock enable (CE), and synchronous reset (R) inputs. The R input, when High, overrides all other inputs during the Low-to-High clock (C) transition and resets the data outputs (Q) Low.

When (CE) is High and (R) is Low, the data on the (SLI) is loaded into the first bit of the shift register during the Low-to-High clock (C) transition and appears on the (Q0) output. During subsequent Low-to-High clock transitions, when (CE) is High and R is Low, data shifts to the next highest bit position as new data is loaded into (Q0) (for example, SLI→Q0, Q0→Q1, and Q1→Q2). The register ignores clock transitions when (CE) is Low.

Registers can be cascaded by connecting the last (Q) output of one stage to the SLI input of the next stage and connecting clock, (CE), and (R) in parallel.

This register is asynchronously cleared, outputs Low, when power is applied. For FPGA devices, power-on conditions are simulated when global set/reset (GSR) is active. GSR defaults to active-High but can be inverted by adding an inverter in front of the GSR input of the appropriate `STARTUP_architecture` symbol.

### Logic Table

Inputs				Outputs	
R	CE	SLI	C	Q0	Qz - Q1
1	X	X	↑	0	0
0	0	X	X	No Change	No Change
0	1	SLI	↑	SLI	qn-1

z = bitwidth -1  
qn-1 = state of referenced output one setup time prior to active clock transition

### Design Entry Method

This design element is only for use in schematics.

### For More Information

- See the [Spartan-3 User Guide](#).
- See the [Spartan-3 Data Sheets](#).

## SR16RLE

Macro: 16-Bit Loadable Serial/Parallel-In Parallel-Out Shift Register with Clock Enable and Synchronous Reset

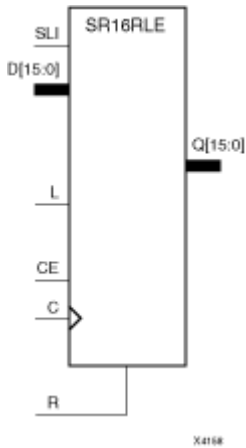

### Introduction

This design element is a shift register with shift-left serial input (SLI), parallel inputs (D), parallel outputs (Q), and three control inputs: clock enable (CE), load enable (L), and synchronous reset (R). The register ignores clock transitions when (L) and (CE) are Low. The synchronous (R), when High, overrides all other inputs during the Low-to-High clock (C) transition and resets the data outputs (Q) Low. When (L) is High and (R) is Low during the Low-to-High clock transition, data on the (D) inputs is loaded into the corresponding Q bits of the register.

When (CE) is High and (L) and (R) are Low, data on the (SLI) input is loaded into the first bit of the shift register during the Low-to-High clock (C) transition and appears on the Q0 output. During subsequent clock transitions, when (CE) is High and (L) and (R) are Low, the data shifts to the next highest bit position as new data is loaded into Q0.

Registers can be cascaded by connecting the last Q output of one stage to the SLI input of the next stage and connecting clock, (CE), (L), and (R) inputs in parallel.

This register is asynchronously cleared, outputs Low, when power is applied. For FPGA devices, power-on conditions are simulated when global set/reset (GSR) is active. GSR defaults to active-High but can be inverted by adding an inverter in front of the GSR input of the appropriate *STARTUP\_architecture* symbol.

### Logic Table

Inputs						Outputs	
R	L	CE	SLI	Dz - D0	C	Q0	Qz - Q1
1	X	X	X	X	↑	0	0
0	1	X	X	Dz - D0	↑	D0	Dn
0	0	1	SLI	X	↑	SLI	qn-1
0	0	0	X	X	X	No Change	No Change
z = bitwidth -1							
qn-1 = state of referenced output one setup time prior to active clock transition							

### Design Entry Method

This design element is only for use in schematics.

---

## For More Information

- See the [Spartan-3 User Guide](#).
- See the [Spartan-3 Data Sheets](#).

# SR16RLED

Macro: 16-Bit Shift Register with Clock Enable and Synchronous Reset

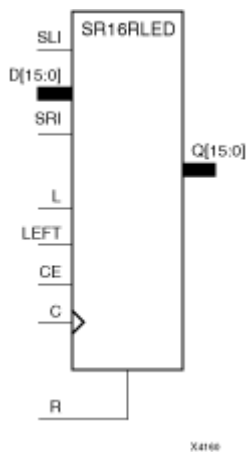

## Introduction

This design element is a shift register with shift-left (SLI) and shift-right (SRI) serial inputs, parallel inputs (D), parallel outputs (Q) and four control inputs — clock enable (CE), load enable (L), shift left/right (LEFT), and synchronous reset (R). The register ignores clock transitions when (CE) and (L) are Low. The synchronous (R), when High, overrides all other inputs during the Low-to-High clock (C) transition and resets the data outputs (Q) Low. When (L) is High and (R) is Low during the Low-to-High clock transition, the data on the (D) inputs is loaded into the corresponding (Q) bits of the register.

When (CE) is High and (L) and (R) are Low, data shifts right or left, depending on the state of the LEFT input. If LEFT is High, data on (SLI) is loaded into (Q0) during the Low-to-High clock transition and shifted left (for example, to Q1 and Q2) during subsequent clock transitions. If LEFT is Low, data on the (SRI) is loaded into the last (Q) output during the Low-to-High clock transition and shifted right ) during subsequent clock transitions. The logic tables below indicates the state of the (Q) outputs under all input conditions.

This register is asynchronously cleared, outputs Low, when power is applied. For FPGA devices, power-on conditions are simulated when global set/reset (GSR) is active. GSR defaults to active-High but can be inverted by adding an inverter in front of the GSR input of the appropriate STARTUP\_architecture symbol.

## Logic Table

Inputs								Outputs		
R	L	CE	LEFT	SLI	SRI	D15 – D0	C	Q0	Q15	Q14 – Q1
1	X	X	X	X	X	X	↑	0	0	0
0	1	X	X	X	X	D15 – D0	↑	D0	D15	Dn
0	0	0	X	X	X	X	X	No Change	No Change	No Change
0	0	1	1	SLI	X	X	↑	SLI	q14	qn-1
0	0	1	0	X	SRI	X	↑	q1	SRI	qn+1

qn-1 or qn+1 = state of referenced output one setup time prior to active clock transition



---

## Design Entry Method

This design element is only for use in schematics.

## For More Information

- See the [Spartan-3 User Guide](#).
- See the [Spartan-3 Data Sheets](#).

## SR4CE

Macro: 4-Bit Serial-In Parallel-Out Shift Register with Clock Enable and Asynchronous Clear

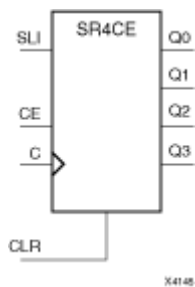

### Introduction

This design element is a shift register with a shift-left serial input (SLI), parallel outputs (Q), and clock enable (CE) and asynchronous clear (CLR) inputs. The (CLR) input, when High, overrides all other inputs and resets the data outputs (Q) Low. When (CE) is High and (CLR) is Low, the data on the SLI input is loaded into the first bit of the shift register during the Low-to-High clock (C) transition and appears on the (Q0) output. During subsequent Low-to-High clock transitions, when (CE) is High and (CLR) is Low, data shifts to the next highest bit position as new data is loaded into (Q0) (SLI→Q0, Q0→Q1, Q1→Q2, and so forth). The register ignores clock transitions when (CE) is Low.

Registers can be cascaded by connecting the last (Q) output of one stage to the SLI input of the next stage and connecting clock, (CE), and (CLR) in parallel.

This register is asynchronously cleared, outputs Low, when power is applied. For FPGA devices, power-on conditions are simulated when global set/reset (GSR) is active. GSR defaults to active-High but can be inverted by adding an inverter in front of the GSR input of the appropriate `STARTUP_architecture` symbol.

### Logic Table

Inputs				Outputs	
CLR	CE	SLI	C	Q0	Qz - Q1
1	X	X	X	0	0
0	0	X	X	No Change	No Change
0	1	SLI	↑	SLI	qn-1

z = bit width - 1  
qn-1 = state of referenced output one setup time prior to active clock transition

### Design Entry Method

This design element is only for use in schematics.

### For More Information

- See the [Spartan-3 User Guide](#).
- See the [Spartan-3 Data Sheets](#).

# SR4CLE

Macro: 4-Bit Loadable Serial/Parallel-In Parallel-Out Shift Register with Clock Enable and Asynchronous Clear

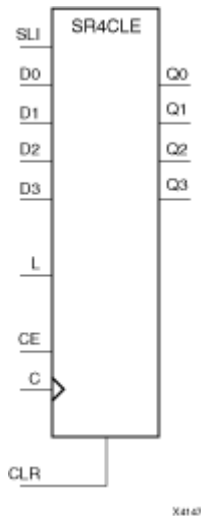

## Introduction

This design element is a shift register with a shift-left serial input (SLI), parallel inputs (D), parallel outputs (Q), and three control inputs: clock enable (CE), load enable (L), and asynchronous clear (CLR) . The register ignores clock transitions when (L) and (CE) are Low. The asynchronous (CLR), when High, overrides all other inputs and resets the data outputs (Q) Low. When (L) is High and (CLR) is Low, data on the Dn – D0 inputs is loaded into the corresponding Qn – (Q0) bits of the register.

When (CE) is High and (L) and (CLR) are Low, data on the SLI input is loaded into the first bit of the shift register during the Low-to-High clock (C) transition and appears on the (Q0) output. During subsequent clock transitions, when (CE) is High and (L) and (CLR) are Low, the data shifts to the next highest bit position as new data is loaded into (Q)0 (for example, SLI→Q0, Q0→Q1, and Q1→Q2).

Registers can be cascaded by connecting the last (Q) output of one stage to the SLI input of the next stage and connecting clock, (CE), (L), and (CLR) inputs in parallel.

This register is asynchronously cleared, outputs Low, when power is applied. For FPGA devices, power-on conditions are simulated when global set/reset (GSR) is active. GSR defaults to active-High but can be inverted by adding an inverter in front of the GSR input of the appropriate STARTUP\_architecture symbol.

## Logic Table

Inputs						Outputs	
CLR	L	CE	SLI	Dn – D0	C	Q0	Qz – Q1
1	X	X	X	X	X	0	0
0	1	X	X	Dn – D0	↑	D0	Dn
0	0	1	SLI	X	↑	SLI	qn-1
0	0	0	X	X	X	No Change	No Change

z = bitwidth -1

qn-1 = state of referenced output one setup time prior to active clock transition

## Design Entry Method

This design element is only for use in schematics.

## For More Information

- See the [Spartan-3 User Guide](#).
- See the [Spartan-3 Data Sheets](#).

## SR4CLED

Macro: 4-Bit Shift Register with Clock Enable and Asynchronous Clear

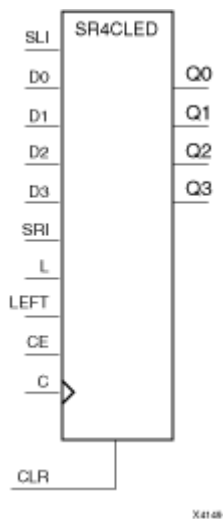

### Introduction

This design element is a shift register with shift-left (SLI) and shift-right (SRI) serial inputs, parallel inputs (D), parallel outputs (Q), and four control inputs: clock enable (CE), load enable (L), shift left/right (LEFT), and asynchronous clear (CLR). The register ignores clock transitions when (CE) and (L) are Low. The asynchronous clear, when High, overrides all other inputs and resets the data outputs (Qn) Low.

When (L) is High and (CLR) is Low, the data on the (D) inputs is loaded into the corresponding (Q) bits of the register. When (CE) is High and (L) and (CLR) are Low, data is shifted right or left, depending on the state of the LEFT input. If LEFT is High, data on the SLI is loaded into (Q0) during the Low-to-High clock transition and shifted left (for example, to Q1 or Q2) during subsequent clock transitions. If LEFT is Low, data on the SRI is loaded into the last (Q) output during the Low-to-High clock transition and shifted right during subsequent clock transitions. The logic tables indicate the state of the (Q) outputs under all input conditions.

This register is asynchronously cleared, outputs Low, when power is applied. For FPGA devices, power-on conditions are simulated when global set/reset (GSR) is active. GSR defaults to active-High but can be inverted by adding an inverter in front of the GSR input of the appropriate STARTUP\_architecture symbol.

### Logic Table

Inputs								Outputs		
CLR	L	CE	LEFT	SLI	SRI	D3 – D0	C	Q0	Q3	Q2 – Q1
1	X	X	X	X	X	X	X	0	0	0
0	1	X	X	X	X	D3– D0	↑	D0	D3	Dn
0	0	0	X	X	X	X	X	No Change	No Change	No Change
0	0	1	1	SLI	X	X	↑	SLI	q2	qn-1
0	0	1	0	X	SRI	X	↑	q1	SRI	qn+1

qn-1 and qn+1 = state of referenced output one setup time prior to active clock transition.

## Design Entry Method

This design element is only for use in schematics.

## For More Information

- See the *Spartan-3 User Guide*.
- See the *Spartan-3 Data Sheets*.

## SR4RE

Macro: 4-Bit Serial-In Parallel-Out Shift Register with Clock Enable and Synchronous Reset

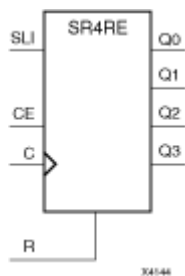

### Introduction

This design element is a shift register with shift-left serial input (SLI), parallel outputs (Qn), clock enable (CE), and synchronous reset (R) inputs. The R input, when High, overrides all other inputs during the Low-to-High clock (C) transition and resets the data outputs (Q) Low.

When (CE) is High and (R) is Low, the data on the (SLI) is loaded into the first bit of the shift register during the Low-to-High clock (C) transition and appears on the (Q0) output. During subsequent Low-to-High clock transitions, when (CE) is High and R is Low, data shifts to the next highest bit position as new data is loaded into (Q0) (for example, SLI→Q0, Q0→Q1, and Q1→Q2). The register ignores clock transitions when (CE) is Low.

Registers can be cascaded by connecting the last (Q) output of one stage to the SLI input of the next stage and connecting clock, (CE), and (R) in parallel.

This register is asynchronously cleared, outputs Low, when power is applied. For FPGA devices, power-on conditions are simulated when global set/reset (GSR) is active. GSR defaults to active-High but can be inverted by adding an inverter in front of the GSR input of the appropriate `STARTUP_architecture` symbol.

### Logic Table

Inputs				Outputs	
R	CE	SLI	C	Q0	Qz - Q1
1	X	X	↑	0	0
0	0	X	X	No Change	No Change
0	1	SLI	↑	SLI	qn-1

z = bitwidth -1  
qn-1 = state of referenced output one setup time prior to active clock transition

### Design Entry Method

This design element is only for use in schematics.

### For More Information

- See the [Spartan-3 User Guide](#).
- See the [Spartan-3 Data Sheets](#).

## SR4RLE

Macro: 4-Bit Loadable Serial/Parallel-In Parallel-Out Shift Register with Clock Enable and Synchronous Reset

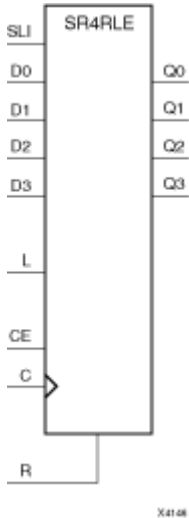

### Introduction

This design element is a shift register with shift-left serial input (SLI), parallel inputs (D), parallel outputs (Q), and three control inputs: clock enable (CE), load enable (L), and synchronous reset (R). The register ignores clock transitions when (L) and (CE) are Low. The synchronous (R), when High, overrides all other inputs during the Low-to-High clock (C) transition and resets the data outputs (Q) Low. When (L) is High and (R) is Low during the Low-to-High clock transition, data on the (D) inputs is loaded into the corresponding Q bits of the register.

When (CE) is High and (L) and (R) are Low, data on the (SLI) input is loaded into the first bit of the shift register during the Low-to-High clock (C) transition and appears on the Q0 output. During subsequent clock transitions, when (CE) is High and (L) and (R) are Low, the data shifts to the next highest bit position as new data is loaded into Q0.

Registers can be cascaded by connecting the last Q output of one stage to the SLI input of the next stage and connecting clock, (CE), (L), and (R) inputs in parallel.

This register is asynchronously cleared, outputs Low, when power is applied. For FPGA devices, power-on conditions are simulated when global set/reset (GSR) is active. GSR defaults to active-High but can be inverted by adding an inverter in front of the GSR input of the appropriate *STARTUP\_architecture* symbol.

### Logic Table

Inputs						Outputs		
R	L	CE	SLI	Dz – D0	C	Q0	Qz – Q1	
1	X	X	X	X	↑	0	0	
0	1	X	X	Dz – D0	↑	D0	Dn	
0	0	1	SLI	X	↑	SLI	qn-1	
0	0	0	X	X	X	No Change	No Change	
z = bitwidth -1								
qn-1 = state of referenced output one setup time prior to active clock transition								



---

## Design Entry Method

This design element is only for use in schematics.

## For More Information

- See the [Spartan-3 User Guide](#).
- See the [Spartan-3 Data Sheets](#).

# SR4RLED

Macro: 4-Bit Shift Register with Clock Enable and Synchronous Reset

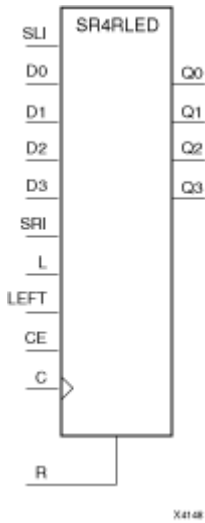

## Introduction

This design element is a shift register with shift-left (SLI) and shift-right (SRI) serial inputs, parallel inputs (D), parallel outputs (Q) and four control inputs — clock enable (CE), load enable (L), shift left/right (LEFT), and synchronous reset (R). The register ignores clock transitions when (CE) and (L) are Low. The synchronous (R), when High, overrides all other inputs during the Low-to-High clock (C) transition and resets the data outputs (Q) Low. When (L) is High and (R) is Low during the Low-to-High clock transition, the data on the (D) inputs is loaded into the corresponding (Q) bits of the register.

When (CE) is High and (L) and (R) are Low, data shifts right or left, depending on the state of the LEFT input. If LEFT is High, data on (SLI) is loaded into (Q0) during the Low-to-High clock transition and shifted left (for example, to Q1 and Q2) during subsequent clock transitions. If LEFT is Low, data on the (SRI) is loaded into the last (Q) output during the Low-to-High clock transition and shifted right ) during subsequent clock transitions. The logic tables below indicates the state of the (Q) outputs under all input conditions.

This register is asynchronously cleared, outputs Low, when power is applied. For FPGA devices, power-on conditions are simulated when global set/reset (GSR) is active. GSR defaults to active-High but can be inverted by adding an inverter in front of the GSR input of the appropriate STARTUP\_architecture symbol.

## Logic Table

Inputs								Outputs		
R	L	CE	LEFT	SLI	SRI	D3 – D0	C	Q0	Q3	Q2 – Q1
1	X	X	X	X	X	X	↑	0	0	0
0	1	X	X	X	X	D3 – D0	↑	D0	D3	Dn
0	0	0	X	X	X	X	X	No Change	No Change	No Change
0	0	1	1	SLI	X	X	↑	SLI	q2	qn-1
0	0	1	0	X	SRI	X	↑	q1	SRI	qn+1

qn-1 or qn+1 = state of referenced output one setup time prior to active clock transition

---

## Design Entry Method

This design element is only for use in schematics.

## For More Information

- See the [Spartan-3 User Guide](#).
- See the [Spartan-3 Data Sheets](#).

## SR8CE

Macro: 8-Bit Serial-In Parallel-Out Shift Register with Clock Enable and Asynchronous Clear

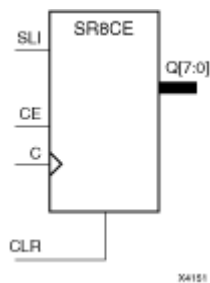

### Introduction

This design element is a shift register with a shift-left serial input (SLI), parallel outputs (Q), and clock enable (CE) and asynchronous clear (CLR) inputs. The (CLR) input, when High, overrides all other inputs and resets the data outputs (Q) Low. When (CE) is High and (CLR) is Low, the data on the SLI input is loaded into the first bit of the shift register during the Low-to-High clock (C) transition and appears on the (Q0) output. During subsequent Low-to-High clock transitions, when (CE) is High and (CLR) is Low, data shifts to the next highest bit position as new data is loaded into (Q0) (SLI→Q0, Q0→Q1, Q1→Q2, and so forth). The register ignores clock transitions when (CE) is Low.

Registers can be cascaded by connecting the last (Q) output of one stage to the SLI input of the next stage and connecting clock, (CE), and (CLR) in parallel.

This register is asynchronously cleared, outputs Low, when power is applied. For FPGA devices, power-on conditions are simulated when global set/reset (GSR) is active. GSR defaults to active-High but can be inverted by adding an inverter in front of the GSR input of the appropriate `STARTUP_architecture` symbol.

### Logic Table

Inputs				Outputs	
CLR	CE	SLI	C	Q0	Qz - Q1
1	X	X	X	0	0
0	0	X	X	No Change	No Change
0	1	SLI	↑	SLI	qn-1

z = bit width - 1  
qn-1 = state of referenced output one setup time prior to active clock transition

### Design Entry Method

This design element is only for use in schematics.

### For More Information

- See the [Spartan-3 User Guide](#).
- See the [Spartan-3 Data Sheets](#).

## SR8CLE

Macro: 8-Bit Loadable Serial/Parallel-In Parallel-Out Shift Register with Clock Enable and Asynchronous Clear

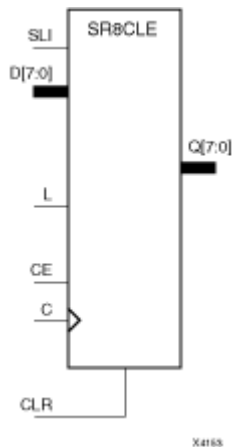

### Introduction

This design element is a shift register with a shift-left serial input (SLI), parallel inputs (D), parallel outputs (Q), and three control inputs: clock enable (CE), load enable (L), and asynchronous clear (CLR). The register ignores clock transitions when (L) and (CE) are Low. The asynchronous (CLR), when High, overrides all other inputs and resets the data outputs (Q) Low. When (L) is High and (CLR) is Low, data on the D<sub>n</sub> – D<sub>0</sub> inputs is loaded into the corresponding Q<sub>n</sub> – (Q<sub>0</sub>) bits of the register.

When (CE) is High and (L) and (CLR) are Low, data on the SLI input is loaded into the first bit of the shift register during the Low-to-High clock (C) transition and appears on the (Q<sub>0</sub>) output. During subsequent clock transitions, when (CE) is High and (L) and (CLR) are Low, the data shifts to the next highest bit position as new data is loaded into (Q<sub>0</sub>) (for example, SLI→Q<sub>0</sub>, Q<sub>0</sub>→Q<sub>1</sub>, and Q<sub>1</sub>→Q<sub>2</sub>).

Registers can be cascaded by connecting the last (Q) output of one stage to the SLI input of the next stage and connecting clock, (CE), (L), and (CLR) inputs in parallel.

This register is asynchronously cleared, outputs Low, when power is applied. For FPGA devices, power-on conditions are simulated when global set/reset (GSR) is active. GSR defaults to active-High but can be inverted by adding an inverter in front of the GSR input of the appropriate *STARTUP\_architecture* symbol.

### Logic Table

Inputs						Outputs	
CLR	L	CE	SLI	D <sub>n</sub> – D <sub>0</sub>	C	Q <sub>0</sub>	Q <sub>z</sub> – Q <sub>1</sub>
1	X	X	X	X	X	0	0
0	1	X	X	D <sub>n</sub> – D <sub>0</sub>	↑	D <sub>0</sub>	D <sub>n</sub>
0	0	1	SLI	X	↑	SLI	qn-1
0	0	0	X	X	X	No Change	No Change

z = bitwidth -1

qn-1 = state of referenced output one setup time prior to active clock transition

### Design Entry Method

This design element is only for use in schematics.

## For More Information

- See the [Spartan-3 User Guide](#).
- See the [Spartan-3 Data Sheets](#).

## SR8CLED

Macro: 8-Bit Shift Register with Clock Enable and Asynchronous Clear

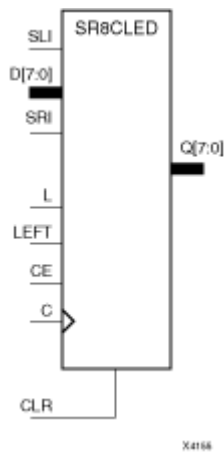

### Introduction

This design element is a shift register with shift-left (SLI) and shift-right (SRI) serial inputs, parallel inputs (D), parallel outputs (Q), and four control inputs: clock enable (CE), load enable (L), shift left/right (LEFT), and asynchronous clear (CLR). The register ignores clock transitions when (CE) and (L) are Low. The asynchronous clear, when High, overrides all other inputs and resets the data outputs (Qn) Low.

When (L) is High and (CLR) is Low, the data on the (D) inputs is loaded into the corresponding (Q) bits of the register. When (CE) is High and (L) and (CLR) are Low, data is shifted right or left, depending on the state of the LEFT input. If LEFT is High, data on the SLI is loaded into (Q0) during the Low-to-High clock transition and shifted left (for example, to Q1 or Q2) during subsequent clock transitions. If LEFT is Low, data on the SRI is loaded into the last (Q) output during the Low-to-High clock transition and shifted right during subsequent clock transitions. The logic tables indicate the state of the (Q) outputs under all input conditions.

This register is asynchronously cleared, outputs Low, when power is applied. For FPGA devices, power-on conditions are simulated when global set/reset (GSR) is active. GSR defaults to active-High but can be inverted by adding an inverter in front of the GSR input of the appropriate STARTUP\_architecture symbol.

### Logic Table

Inputs								Outputs		
CLR	L	CE	LEFT	SLI	SRI	D7 – D0	C	Q0	Q7	Q6 – Q1
1	X	X	X	X	X	X	X	0	0	0
0	1	X	X	X	X	D7 – D0	↑	D0	D7	Dn
0	0	0	X	X	X	X	X	No Change	No Change	No Change
0	0	1	1	SLI	X	X	↑	SLI	q6	qn-1
0	0	1	0	X	SRI	X	↑	q1	SRI	qn+1

qn-1 or qn+1 = state of referenced output one setup time prior to active clock transition.

### Design Entry Method

This design element is only for use in schematics.

## For More Information

- See the [Spartan-3 User Guide](#).
- See the [Spartan-3 Data Sheets](#).



## SR8RE

Macro: 8-Bit Serial-In Parallel-Out Shift Register with Clock Enable and Synchronous Reset

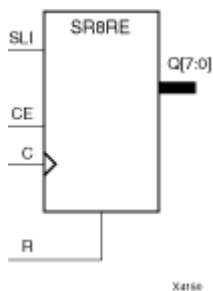

### Introduction

This design element is a shift register with shift-left serial input (SLI), parallel outputs (Qn), clock enable (CE), and synchronous reset (R) inputs. The R input, when High, overrides all other inputs during the Low-to-High clock (C) transition and resets the data outputs (Q) Low.

When (CE) is High and (R) is Low, the data on the (SLI) is loaded into the first bit of the shift register during the Low-to-High clock (C) transition and appears on the (Q0) output. During subsequent Low-to-High clock transitions, when (CE) is High and R is Low, data shifts to the next highest bit position as new data is loaded into (Q0) (for example, SLI→Q0, Q0→Q1, and Q1→Q2). The register ignores clock transitions when (CE) is Low.

Registers can be cascaded by connecting the last (Q) output of one stage to the SLI input of the next stage and connecting clock, (CE), and (R) in parallel.

This register is asynchronously cleared, outputs Low, when power is applied. For FPGA devices, power-on conditions are simulated when global set/reset (GSR) is active. GSR defaults to active-High but can be inverted by adding an inverter in front of the GSR input of the appropriate `STARTUP_architecture` symbol.

### Logic Table

Inputs				Outputs	
R	CE	SLI	C	Q0	Qz - Q1
1	X	X	↑	0	0
0	0	X	X	No Change	No Change
0	1	SLI	↑	SLI	qn-1

z = bitwidth -1  
qn-1 = state of referenced output one setup time prior to active clock transition

### Design Entry Method

This design element is only for use in schematics.

### For More Information

- See the [Spartan-3 User Guide](#).
- See the [Spartan-3 Data Sheets](#).

# SR8RLE

Macro: 8-Bit Loadable Serial/Parallel-In Parallel-Out Shift Register with Clock Enable and Synchronous Reset

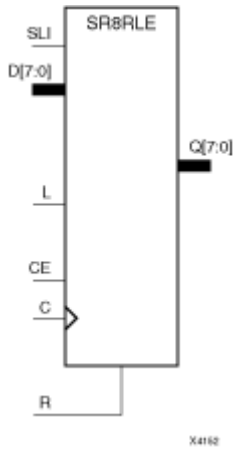

## Introduction

This design element is a shift register with shift-left serial input (SLI), parallel inputs (D), parallel outputs (Q), and three control inputs: clock enable (CE), load enable (L), and synchronous reset (R). The register ignores clock transitions when (L) and (CE) are Low. The synchronous (R), when High, overrides all other inputs during the Low-to-High clock (C) transition and resets the data outputs (Q) Low. When (L) is High and (R) is Low during the Low-to-High clock transition, data on the (D) inputs is loaded into the corresponding Q bits of the register.

When (CE) is High and (L) and (R) are Low, data on the (SLI) input is loaded into the first bit of the shift register during the Low-to-High clock (C) transition and appears on the Q0 output. During subsequent clock transitions, when (CE) is High and (L) and (R) are Low, the data shifts to the next highest bit position as new data is loaded into Q0.

Registers can be cascaded by connecting the last Q output of one stage to the SLI input of the next stage and connecting clock, (CE), (L), and (R) inputs in parallel.

This register is asynchronously cleared, outputs Low, when power is applied. For FPGA devices, power-on conditions are simulated when global set/reset (GSR) is active. GSR defaults to active-High but can be inverted by adding an inverter in front of the GSR input of the appropriate *STARTUP\_architecture* symbol.

## Logic Table

Inputs						Outputs		
R	L	CE	SLI	Dz - D0	C	Q0	Qz - Q1	
1	X	X	X	X	↑	0	0	
0	1	X	X	Dz - D0	↑	D0	Dn	
0	0	1	SLI	X	↑	SLI	qn-1	
0	0	0	X	X	X	No Change	No Change	
z = bitwidth -1								
qn-1 = state of referenced output one setup time prior to active clock transition								

## Design Entry Method

This design element is only for use in schematics.

---

## For More Information

- See the [Spartan-3 User Guide](#).
- See the [Spartan-3 Data Sheets](#).

# SR8RLED

Macro: 8-Bit Shift Register with Clock Enable and Synchronous Reset

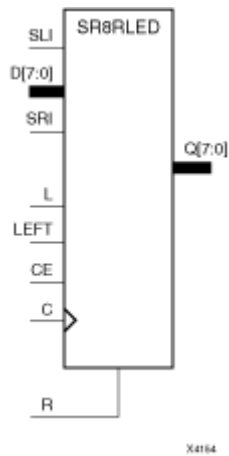

## Introduction

This design element is a shift register with shift-left (SLI) and shift-right (SRI) serial inputs, parallel inputs (D), parallel outputs (Q) and four control inputs — clock enable (CE), load enable (L), shift left/right (LEFT), and synchronous reset (R). The register ignores clock transitions when (CE) and (L) are Low. The synchronous (R), when High, overrides all other inputs during the Low-to-High clock (C) transition and resets the data outputs (Q) Low. When (L) is High and (R) is Low during the Low-to-High clock transition, the data on the (D) inputs is loaded into the corresponding (Q) bits of the register.

When (CE) is High and (L) and (R) are Low, data shifts right or left, depending on the state of the LEFT input. If LEFT is High, data on (SLI) is loaded into (Q0) during the Low-to-High clock transition and shifted left (for example, to Q1 and Q2) during subsequent clock transitions. If LEFT is Low, data on the (SRI) is loaded into the last (Q) output during the Low-to-High clock transition and shifted right ) during subsequent clock transitions. The logic tables below indicates the state of the (Q) outputs under all input conditions.

This register is asynchronously cleared, outputs Low, when power is applied. For FPGA devices, power-on conditions are simulated when global set/reset (GSR) is active. GSR defaults to active-High but can be inverted by adding an inverter in front of the GSR input of the appropriate STARTUP\_architecture symbol.

## Logic Table

Inputs								Outputs		
R	L	CE	LEFT	SLI	SRI	D7– D0	C	Q0	Q7	Q6 – Q1
1	X	X	X	X	X	X	↑	0	0	0
0	1	X	X	X	X	D7 – D0	↑	D0	D7	Dn
0	0	0	X	X	X	X	X	No Change	No Change	No Change
0	0	1	1	SLI	X	X	↑	SLI	q6	qn-1
0	0	1	0	X	SRI	X	↑	q1	SRI	qn+1
qn-1 or qn+1 = state of referenced output one setup time prior to active clock transition										

## Design Entry Method

This design element is only for use in schematics.

---

## For More Information

- See the [Spartan-3 User Guide](#).
- See the [Spartan-3 Data Sheets](#).

## SRL16

Primitive: 16-Bit Shift Register Look-Up-Table (LUT)

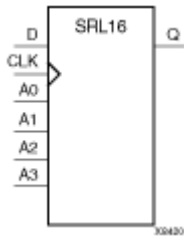

### Introduction

This design element is a shift register look-up table (LUT). The inputs A3, A2, A1, and A0 select the output length of the shift register.

The shift register can be of a fixed, static length or it can be dynamically adjusted.

- **To create a fixed-length shift register** - Drive the A3 through A0 inputs with static values. The length of the shift register can vary from 1 bit to 16 bits, as determined by the following formula:  $\text{Length} = (8 \times A3) + (4 \times A2) + (2 \times A1) + A0 + 1$ . If A3, A2, A1, and A0 are all zeros (0000), the shift register is one bit long. If they are all ones (1111), it is 16 bits long.
- **To change the length of the shift register dynamically** - Change the values driving the A3 through A0 inputs. For example, if A2, A1, and A0 are all ones (111) and A3 toggles between a one (1) and a zero (0), the length of the shift register changes from 16 bits to 8 bits. Internally, the length of the shift register is always 16 bits and the input lines A3 through A0 select which of the 16 bits reach the output.

The shift register LUT contents are initialized by assigning a four-digit hexadecimal number to an INIT attribute. The first, or the left-most, hexadecimal digit is the most significant bit. If an INIT value is not specified, it defaults to a value of four zeros (0000) so that the shift register LUT is cleared during configuration.

The data (D) is loaded into the first bit of the shift register during the Low-to-High clock (CLK) transition. During subsequent Low-to-High clock transitions data shifts to the next highest bit position while new data is loaded. The data appears on the Q output when the shift register length determined by the address inputs is reached.

### Logic Table

Inputs			Output
A <sub>m</sub>	CLK	D	Q
A <sub>m</sub>	X	X	Q(A <sub>m</sub> )
A <sub>m</sub>	↑	D	Q(A <sub>m</sub> - 1)
m = 0, 1, 2, 3			

### Design Entry Method

This design element can be used in schematics.

### Available Attributes

Attribute	Type	Allowed Values	Default	Description
INIT	Hexadecimal	Any 16-Bit Value	All zeros	Sets the initial value of Q output after configuration.

---

## For More Information

- See the [Spartan-3 User Guide](#).
- See the [Spartan-3 Data Sheets](#).

## SRL16\_1

Primitive: 16-Bit Shift Register Look-Up-Table (LUT) with Negative-Edge Clock

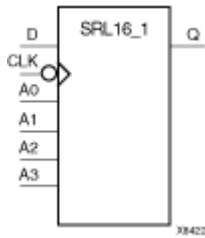

### Introduction

This design element is a shift register look-up table (LUT). The inputs A3, A2, A1, and A0 select the output length of the shift register.

The shift register can be of a fixed, static length or it can be dynamically adjusted.

- **To create a fixed-length shift register** - Drive the A3 through A0 inputs with static values. The length of the shift register can vary from 1 bit to 16 bits, as determined by the following formula:  $\text{Length} = (8 \times A3) + (4 \times A2) + (2 \times A1) + A0 + 1$ . If A3, A2, A1, and A0 are all zeros (0000), the shift register is one bit long. If they are all ones (1111), it is 16 bits long.
- **To change the length of the shift register dynamically** - Change the values driving the A3 through A0 inputs. For example, if A2, A1, and A0 are all ones (111) and A3 toggles between a one (1) and a zero (0), the length of the shift register changes from 16 bits to 8 bits. Internally, the length of the shift register is always 16 bits and the input lines A3 through A0 select which of the 16 bits reach the output.

The shift register LUT contents are initialized by assigning a four-digit hexadecimal number to an INIT attribute. The first, or the left-most, hexadecimal digit is the most significant bit. If an INIT value is not specified, it defaults to a value of four zeros (0000) so that the shift register LUT is cleared during configuration.

The data (D) is loaded into the first bit of the shift register during the High-to-Low clock (CLK) transition. During subsequent High-to-Low clock transitions data shifts to the next highest bit position as new data is loaded. The data appears on the Q output when the shift register length determined by the address inputs is reached.

### Logic Table

Inputs			Output
A <sub>m</sub>	CLK	D	Q
A <sub>m</sub>	X	X	Q(A <sub>m</sub> )
A <sub>m</sub>	↓	D	Q(A <sub>m</sub> - 1)
m = 0, 1, 2, 3			

### Design Entry Method

This design element can be used in schematics.

### Available Attributes

Attribute	Type	Allowed Values	Default	Description
INIT	Hexadecimal	Any 16-Bit Value	All zeros	Sets the initial value of Q output after configuration



---

## For More Information

- See the [Spartan-3 User Guide](#).
- See the [Spartan-3 Data Sheets](#).

## SRL16E

Primitive: 16-Bit Shift Register Look-Up-Table (LUT) with Clock Enable

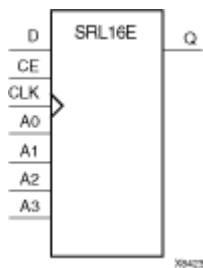

### Introduction

This design element is a shift register look-up table (LUT). The inputs A3, A2, A1, and A0 select the output length of the shift register.

The shift register can be of a fixed, static length or it can be dynamically adjusted.

- To create a fixed-length shift register** - Drive the A3 through A0 inputs with static values. The length of the shift register can vary from 1 bit to 16 bits, as determined by the following formula:  $\text{Length} = (8 \times A3) + (4 \times A2) + (2 \times A1) + A0 + 1$ . If A3, A2, A1, and A0 are all zeros (0000), the shift register is one bit long. If they are all ones (1111), it is 16 bits long.
- To change the length of the shift register dynamically** - Change the values driving the A3 through A0 inputs. For example, if A2, A1, and A0 are all ones (111) and A3 toggles between a one (1) and a zero (0), the length of the shift register changes from 16 bits to 8 bits. Internally, the length of the shift register is always 16 bits and the input lines A3 through A0 select which of the 16 bits reach the output.

The shift register LUT contents are initialized by assigning a four-digit hexadecimal number to an INIT attribute. The first, or the left-most, hexadecimal digit is the most significant bit. If an INIT value is not specified, it defaults to a value of four zeros (0000) so that the shift register LUT is cleared during configuration.

When CE is High, the data (D) is loaded into the first bit of the shift register during the Low-to-High clock (CLK) transition. During subsequent Low-to-High clock transitions, when CE is High, data shifts to the next highest bit position as new data is loaded. The data appears on the Q output when the shift register length determined by the address inputs is reached. When CE is Low, the register ignores clock transitions.

### Logic Table

Inputs				Output
A <sub>m</sub>	CE	CLK	D	Q
A <sub>m</sub>	0	X	X	Q(A <sub>m</sub> )
A <sub>m</sub>	1	↑	D	Q(A <sub>m</sub> - 1)
m = 0, 1, 2, 3				

### Design Entry Method

This design element can be used in schematics.

## Available Attributes

Attribute	Type	Allowed Values	Default	Description
INIT	Hexadecimal	Any 16-Bit Value	All zeros	Sets the initial value of content and output of shift register after configuration.

## For More Information

- See the [Spartan-3 User Guide](#).
- See the [Spartan-3 Data Sheets](#).

## SRL16E\_1

Primitive: 16-Bit Shift Register Look-Up-Table (LUT) with Negative-Edge Clock and Clock Enable

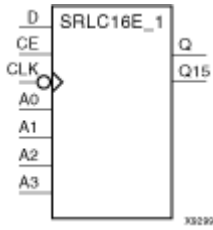

### Introduction

This design element is a shift register look up table (LUT) with clock enable (CE). The inputs A3, A2, A1, and A0 select the output length of the shift register.

The shift register can be of a fixed, static length or it can be dynamically adjusted.

- **To create a fixed-length shift register** - Drive the A3 through A0 inputs with static values. The length of the shift register can vary from 1 bit to 16 bits, as determined by the following formula:  $\text{Length} = (8 \times A3) + (4 \times A2) + (2 \times A1) + A0 + 1$ . If A3, A2, A1, and A0 are all zeros (0000), the shift register is one bit long. If they are all ones (1111), it is 16 bits long.
- **To change the length of the shift register dynamically** - Change the values driving the A3 through A0 inputs. For example, if A2, A1, and A0 are all ones (111) and A3 toggles between a one (1) and a zero (0), the length of the shift register changes from 16 bits to 8 bits. Internally, the length of the shift register is always 16 bits and the input lines A3 through A0 select which of the 16 bits reach the output.

The shift register LUT contents are initialized by assigning a four-digit hexadecimal number to an INIT attribute. The first, or the left-most, hexadecimal digit is the most significant bit. If an INIT value is not specified, it defaults to a value of four zeros (0000) so that the shift register LUT is cleared during configuration.

When CE is High, the data (D) is loaded into the first bit of the shift register during the High-to-Low clock (CLK) transition. During subsequent High-to-Low clock transitions, when CE is High, data is shifted to the next highest bit position as new data is loaded. The data appears on the Q output when the shift register length determined by the address inputs is reached. When CE is Low, the register ignores clock transitions.

### Logic Table

Inputs				Output
A <sub>m</sub>	CE	CLK	D	Q
A <sub>m</sub>	0	X	X	Q(A <sub>m</sub> )
A <sub>m</sub>	1	↓	D	Q(A <sub>m</sub> - 1)
m = 0, 1, 2, 3				

### Design Entry Method

This design element can be used in schematics.

### Available Attributes

Attribute	Type	Allowed Values	Default	Description
INIT	Hexadecimal	16-Bit Hexadecimal	All zeros	Sets the initial value of content and output of shift register after configuration.

---

## For More Information

- See the [Spartan-3 User Guide](#).
- See the [Spartan-3 Data Sheets](#).

## SRLC16

Primitive: 16-Bit Shift Register Look-Up Table (LUT) with Carry

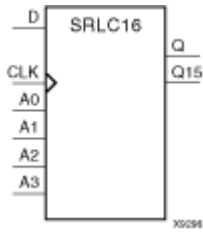

### Introduction

This design element is a shift register look-up table (LUT) with Carry. The inputs A3, A2, A1, and A0 select the output length of the shift register.

The shift register can be of a fixed, static length or it can be dynamically adjusted.

- **To create a fixed-length shift register** - Drive the A3 through A0 inputs with static values. The length of the shift register can vary from 1 bit to 16 bits, as determined by the following formula:  $\text{Length} = (8 \times A3) + (4 \times A2) + (2 \times A1) + A0 + 1$ . If A3, A2, A1, and A0 are all zeros (0000), the shift register is one bit long. If they are all ones (1111), it is 16 bits long.
- **To change the length of the shift register dynamically** - Change the values driving the A3 through A0 inputs. For example, if A2, A1, and A0 are all ones (111) and A3 toggles between a one (1) and a zero (0), the length of the shift register changes from 16 bits to 8 bits. Internally, the length of the shift register is always 16 bits and the input lines A3 through A0 select which of the 16 bits reach the output.

The shift register LUT contents are initialized by assigning a four-digit hexadecimal number to an INIT attribute. The first, or the left-most, hexadecimal digit is the most significant bit. If an INIT value is not specified, it defaults to a value of four zeros (0000) so that the shift register LUT is cleared during configuration.

The data (D) is loaded into the first bit of the shift register during the Low-to-High clock (CLK) transition. During subsequent Low-to-High clock transitions data shifts to the next highest bit position as new data is loaded. The data appears on the Q output when the shift register length determined by the address inputs is reached. The Q15 output is available for you in cascading to multiple shift register LUTs to create larger shift registers.

### Logic Table

Inputs			Output
Am	CLK	D	Q
Am	X	X	Q(Am)
Am	↑	D	Q(Am - 1)
m= 0, 1, 2, 3			

### Design Entry Method

This design element can be used in schematics.

### Available Attributes

Attribute	Type	Allowed Values	Default	Description
INIT	Hexadecimal	Any 16-Bit Value	All zeros	Sets the initial value of content and output of shift register after configuration.

---

## For More Information

- See the [Spartan-3 User Guide](#).
- See the [Spartan-3 Data Sheets](#).

## SRLC16\_1

Primitive: 16-Bit Shift Register Look-Up Table (LUT) with Carry and Negative-Edge Clock

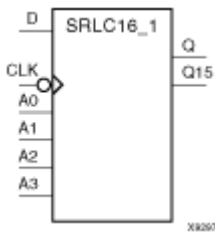

### Introduction

This design element is a shift register look-up table (LUT) with carry and a negative-edge clock. The inputs A3, A2, A1, and A0 select the output length of the shift register.

The shift register can be of a fixed, static length or it can be dynamically adjusted.

- **To create a fixed-length shift register** - Drive the A3 through A0 inputs with static values. The length of the shift register can vary from 1 bit to 16 bits, as determined by the following formula:  $\text{Length} = (8 \times A3) + (4 \times A2) + (2 \times A1) + A0 + 1$ . If A3, A2, A1, and A0 are all zeros (0000), the shift register is one bit long. If they are all ones (1111), it is 16 bits long.
- **To change the length of the shift register dynamically** - Change the values driving the A3 through A0 inputs. For example, if A2, A1, and A0 are all ones (111) and A3 toggles between a one (1) and a zero (0), the length of the shift register changes from 16 bits to 8 bits. Internally, the length of the shift register is always 16 bits and the input lines A3 through A0 select which of the 16 bits reach the output.

The shift register LUT contents are initialized by assigning a four-digit hexadecimal number to an INIT attribute. The first, or the left-most, hexadecimal digit is the most significant bit. If an INIT value is not specified, it defaults to a value of four zeros (0000) so that the shift register LUT is cleared during configuration.

The Q15 output is available for your use in cascading multiple shift register LUTs to create larger shift registers.

### Logic Table

Inputs			Output	
A <sub>m</sub>	CLK	D	Q	Q15
A <sub>m</sub>	X	X	Q(A <sub>m</sub> )	No Change
A <sub>m</sub>	↓	D	Q(A <sub>m</sub> - 1)	Q14
m = 0, 1, 2, 3				

### Design Entry Method

This design element can be used in schematics.

### Available Attributes

Attribute	Type	Allowed Values	Default	Description
INIT	Hexadecimal	Any 16-Bit Value	All zeros	Sets the initial value of content and output of shift register after configuration.



---

## For More Information

- See the [Spartan-3 User Guide](#).
- See the [Spartan-3 Data Sheets](#).

## SRLC16E

Primitive: 16-Bit Shift Register Look-Up Table (LUT) with Carry and Clock Enable

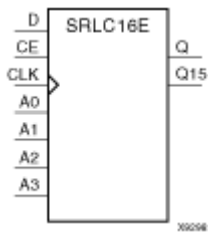

### Introduction

This design element is a shift register look-up table (LUT) with carry and clock enable. The inputs A3, A2, A1, and A0 select the output length of the shift register.

The shift register can be of a fixed, static length or it can be dynamically adjusted.

- **To create a fixed-length shift register** - Drive the A3 through A0 inputs with static values. The length of the shift register can vary from 1 bit to 16 bits, as determined by the following formula:  $\text{Length} = (8 \times A3) + (4 \times A2) + (2 \times A1) + A0 + 1$ . If A3, A2, A1, and A0 are all zeros (0000), the shift register is one bit long. If they are all ones (1111), it is 16 bits long.
- **To change the length of the shift register dynamically** - Change the values driving the A3 through A0 inputs. For example, if A2, A1, and A0 are all ones (111) and A3 toggles between a one (1) and a zero (0), the length of the shift register changes from 16 bits to 8 bits. Internally, the length of the shift register is always 16 bits and the input lines A3 through A0 select which of the 16 bits reach the output.

The shift register LUT contents are initialized by assigning a four-digit hexadecimal number to an INIT attribute. The first, or the left-most, hexadecimal digit is the most significant bit. If an INIT value is not specified, it defaults to a value of four zeros (0000) so that the shift register LUT is cleared during configuration.

The data (D) is loaded into the first bit of the shift register during the Low-to-High clock (CLK) transition. When CE is High, during subsequent Low-to-High clock transitions, data shifts to the next highest bit position as new data is loaded. The data appears on the Q output when the shift register length determined by the address inputs is reached.

The Q15 output is available for you in cascading to multiple shift register LUTs to create larger shift registers.

### Logic Table

Inputs				Output	
Am	CLK	CE	D	Q	Q15
Am	X	0	X	Q(Am)	Q(15)
Am	X	1	X	Q(Am)	Q(15)
Am	↑	1	D	Q(Am - 1)	Q15
m= 0, 1, 2, 3					

### Design Entry Method

This design element can be used in schematics.

### Available Attributes

---

Attribute	Type	Allowed Values	Default	Description
INIT	Hexadecimal	Any 16-Bit Value	All zeros	Sets the initial value of content and output of shift register after configuration.

### For More Information

- See the [Spartan-3 User Guide](#).
- See the [Spartan-3 Data Sheets](#).

# SRLC16E\_1

Primitive: 16-Bit Shift Register Look-Up Table (LUT) with Carry, Negative-Edge Clock, and Clock Enable

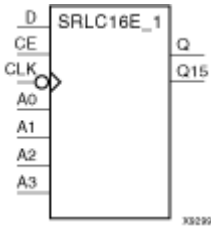

## Introduction

This design element is a shift register look-up table (LUT) with carry, clock enable, and negative-edge clock. The inputs A3, A2, A1, and A0 select the output length of the shift register.

The shift register can be of a fixed, static length or it can be dynamically adjusted.

- **To create a fixed-length shift register** - Drive the A3 through A0 inputs with static values. The length of the shift register can vary from 1 bit to 16 bits, as determined by the following formula:  $\text{Length} = (8 \times A3) + (4 \times A2) + (2 \times A1) + A0 + 1$ . If A3, A2, A1, and A0 are all zeros (0000), the shift register is one bit long. If they are all ones (1111), it is 16 bits long.
- **To change the length of the shift register dynamically** - Change the values driving the A3 through A0 inputs. For example, if A2, A1, and A0 are all ones (111) and A3 toggles between a one (1) and a zero (0), the length of the shift register changes from 16 bits to 8 bits. Internally, the length of the shift register is always 16 bits and the input lines A3 through A0 select which of the 16 bits reach the output.

The shift register LUT contents are initialized by assigning a four-digit hexadecimal number to an INIT attribute. The first, or the left-most, hexadecimal digit is the most significant bit. If an INIT value is not specified, it defaults to a value of four zeros (0000) so that the shift register LUT is cleared during configuration.

When CE is High, the data (D) is loaded into the first bit of the shift register during the High-to-Low clock (CLK) transition. During subsequent High-to-Low clock transitions data shifts to the next highest bit position as new data is loaded when CE is High. The data appears on the Q output when the shift register length determined by the address inputs is reached.

The Q15 output is available for your use in cascading multiple shift register LUTs to create larger shift registers.

## Logic Table

Inputs				Output	
A <sub>m</sub>	CE	CLK	D	Q	Q15
A <sub>m</sub>	0	X	X	Q(A <sub>m</sub> )	No Change
A <sub>m</sub>	1	X	X	Q(A <sub>m</sub> )	No Change
A <sub>m</sub>	1	↓	D	Q(A <sub>m</sub> - 1)	Q14
m = 0, 1, 2, 3					

## Design Entry Method

This design element can be used in schematics.

## Available Attributes

Attribute	Type	Allowed Values	Default	Description
INIT	Hexadecimal	Any 16-Bit Value	All zeros	Sets the initial value of content and output of shift register after configuration.

## For More Information

- See the [Spartan-3 User Guide](#).
- See the [Spartan-3 Data Sheets](#).

## STARTBUF\_SPARTAN3

Primitive: VHDL Simulation of FPGA Designs

### Introduction

This design element is used for VHDL simulation of FPGA designs that require the use of the STARTUP block. The difference between the STARTBUF and the STARTUP block is that the STARTBUF contains output ports which may be connected to all register set/resets in the design (GSR0UT) or to all I/O three-state controls (GTS0UT) so that these functions may be functionally simulated. This design element should not be used for Verilog or schematic entry. In order to use the STARTBUF, the desired input(s) should be connected to a top-level port in the design and the corresponding output(s) must be connected to either the three-state control signal for all inferred and instantiated output buffers in the design (GTS0UT) or all inferred or instantiated register set/resets in the design.

During simulation, the inputs to the STARTBUF can be toggled by the testbench in order to activate the global three-state or global set/reset signal in the design. This should be done at the beginning of the simulation to simulate the behavior of the registers and I/O during configuration. It may also be applied during simulation to simulate a reconfiguration (ProG pin high) of the device. During synthesis and implementation, this component will be treated as a STARTUP block. The connected input ports to this component should remain in the design and be connected to the correct corresponding global resource.

The value at port GSR0UT will always be the value at port GSRIN. The value at port GTS0UT will always be the value at port GTSIN. CLKIN has no effect on simulation.

### Design Entry Method

This design element is only for use in schematics.

### For More Information

- See the [Spartan-3 User Guide](#).
- See the [Spartan-3 Data Sheets](#).

## STARTUP\_SPARTAN3

Primitive: Spartan-3 User Interface to Global Clock, Reset, and 3-State Controls

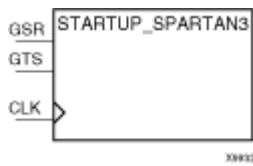

### Introduction

This design element is used for Global Set/Reset, global 3-state control, and the user configuration clock. The Global Set/Reset (GSR) input, when High, sets or resets all flip-flops, all latches, and every block RAMB16 output register in the device, depending on the initialization state (INIT=1 or 0) of the component.

**Note** Block RAM content, LUT RAMs, the Digital Clock Manager (DCM), and shift register LUTs (SRL16, SRL16\_1, SRL16E, SRL16E\_1, SRLC16, SRLC16\_1, SRLC16E, and SRLC16E\_1) are not set/reset.

Following configuration, the global 3-state control (GTS), when High—and BSCAN is not enabled and executing an EXTEST instruction—forces all the IOB outputs into high impedance mode, which isolates the device outputs from the circuit but leaves the inputs active.

**Note** GTS= Global 3-State

Including the STARTUP\_SPARTAN3 symbol in a design is optional. You must include the symbol under the following conditions.

- To exert external control over global set/reset, connect the GSR pin to a top level port and an IBUF.
- To exert external control over global 3-state, connect the GTS pin to a top level port and IBUF.
- To synchronize startup to a user clock, connect the user clock signal to the CLK input. Furthermore, “user clock” must be selected in the BitGen program.

You can use location constraints to specify the pin from which GSR or GTS (or both) is accessed.

### Design Entry Method

This design element can be used in schematics.

### For More Information

- See the [Spartan-3 User Guide](#).
- See the [Spartan-3 Data Sheets](#).

# VCC

Primitive: VCC-Connection Signal Tag



## Introduction

This design element serves as a signal tag, or parameter, that forces a net or input function to a logic High level. A net tied to this element cannot have any other source.

When the placement and routing software encounters a net or input function tied to this element, it removes any logic that is disabled by the Vcc signal, which is only implemented when the disabled logic cannot be removed.

## Design Entry Method

This design element is only for use in schematics.

## For More Information

- See the [Spartan-3 User Guide](#).
- See the [Spartan-3 Data Sheets](#).



## XNOR2

Primitive: 2-Input XNOR Gate with Non-Inverted Inputs

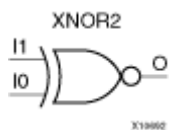

### Introduction

XNOR functions of up to nine inputs are available. All inputs are non-inverting. Because each input uses a CLB resource, replace functions with unused inputs with functions having the necessary number of inputs.

### Logic Table

Input	Output
I0 ... Iz	O
Odd number of 1	0
Even number of 1	1

### Design Entry Method

This design element is only for use in schematics.

### For More Information

- See the [Spartan-3 User Guide](#).
- See the [Spartan-3 Data Sheets](#).

## XNOR3

Primitive: 3-Input XNOR Gate with Non-Inverted Inputs

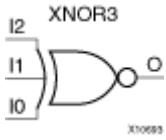

### Introduction

XNOR functions of up to nine inputs are available. All inputs are non-inverting. Because each input uses a CLB resource, replace functions with unused inputs with functions having the necessary number of inputs.

### Logic Table

Input	Output
I0 ... Iz	O
Odd number of 1	0
Even number of 1	1

### Design Entry Method

This design element is only for use in schematics.

### For More Information

- See the [Spartan-3 User Guide](#).
- See the [Spartan-3 Data Sheets](#).

## XNOR4

Primitive: 4-Input XNOR Gate with Non-Inverted Inputs

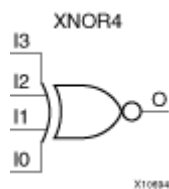

### Introduction

XNOR functions of up to nine inputs are available. All inputs are non-inverting. Because each input uses a CLB resource, replace functions with unused inputs with functions having the necessary number of inputs.

### Logic Table

Input	Output
I0 ... Iz	O
Odd number of 1	0
Even number of 1	1

### Design Entry Method

This design element is only for use in schematics.

### For More Information

- See the [Spartan-3 User Guide](#).
- See the [Spartan-3 Data Sheets](#).

## XNOR5

Primitive: 5-Input XNOR Gate with Non-Inverted Inputs

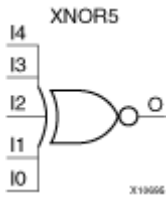

### Introduction

XNOR functions of up to nine inputs are available. All inputs are non-inverting. Because each input uses a CLB resource, replace functions with unused inputs with functions having the necessary number of inputs.

### Logic Table

Input	Output
I0 ... Iz	O
Odd number of 1	0
Even number of 1	1

### Design Entry Method

This design element is only for use in schematics.

### For More Information

- See the [Spartan-3 User Guide](#).
- See the [Spartan-3 Data Sheets](#).

## XNOR6

Macro: 6-Input XNOR Gate with Non-Inverted Inputs

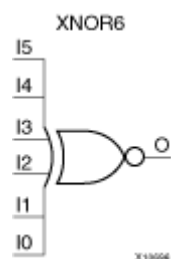

### Introduction

XNOR functions of up to nine inputs are available. All inputs are non-inverting. Because each input uses a CLB resource, replace functions with unused inputs with functions having the necessary number of inputs.

### Logic Table

Input	Output
I0 ... Iz	O
Odd number of 1	0
Even number of 1	1

### Design Entry Method

This design element is only for use in schematics.

### For More Information

- See the [Spartan-3 User Guide](#).
- See the [Spartan-3 Data Sheets](#).

## XNOR7

Macro: 7-Input XNOR Gate with Non-Inverted Inputs

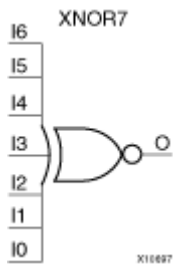

### Introduction

XNOR functions of up to nine inputs are available. All inputs are non-inverting. Because each input uses a CLB resource, replace functions with unused inputs with functions having the necessary number of inputs.

### Logic Table

Input	Output
I0 ... Iz	O
Odd number of 1	0
Even number of 1	1

### Design Entry Method

This design element is only for use in schematics.

### For More Information

- See the [Spartan-3 User Guide](#).
- See the [Spartan-3 Data Sheets](#).

# XNOR8

Macro: 8-Input XNOR Gate with Non-Inverted Inputs

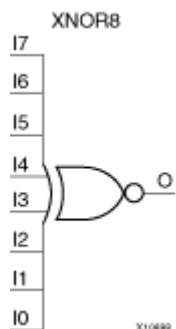

## Introduction

XNOR functions of up to nine inputs are available. All inputs are non-inverting. Because each input uses a CLB resource, replace functions with unused inputs with functions having the necessary number of inputs.

## Logic Table

Input	Output
I0 ... Iz	O
Odd number of 1	0
Even number of 1	1

## Design Entry Method

This design element is only for use in schematics.

## For More Information

- See the [Spartan-3 User Guide](#).
- See the [Spartan-3 Data Sheets](#).

## XNOR9

Macro: 9-Input XNOR Gate with Non-Inverted Inputs

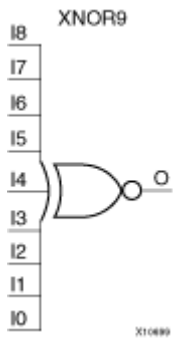

### Introduction

XNOR functions of up to nine inputs are available. All inputs are non-inverting. Because each input uses a CLB resource, replace functions with unused inputs with functions having the necessary number of inputs.

### Logic Table

Input	Output
I0 ... Iz	O
Odd number of 1	0
Even number of 1	1

### Design Entry Method

This design element is only for use in schematics.

### For More Information

- See the [Spartan-3 User Guide](#).
- See the [Spartan-3 Data Sheets](#).



## XOR2

Primitive: 2-Input XOR Gate with Non-Inverted Inputs



### Introduction

XOR functions of up to nine inputs are available. All inputs are non-inverting. Because each input uses a CLB resource, replace functions with unused inputs with functions having the necessary number of inputs.

### Design Entry Method

This design element is only for use in schematics.

### For More Information

- See the [Spartan-3 User Guide](#).
- See the [Spartan-3 Data Sheets](#).

## XOR3

Primitive: 3-Input XOR Gate with Non-Inverted Inputs

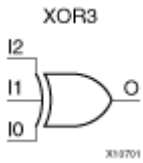

### Introduction

XOR functions of up to nine inputs are available. All inputs are non-inverting. Because each input uses a CLB resource, replace functions with unused inputs with functions having the necessary number of inputs.

### Design Entry Method

This design element is only for use in schematics.

### For More Information

- See the [Spartan-3 User Guide](#).
- See the [Spartan-3 Data Sheets](#).

## XOR4

Primitive: 4-Input XOR Gate with Non-Inverted Inputs

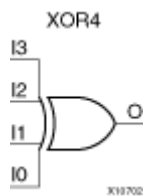

### Introduction

XOR functions of up to nine inputs are available. All inputs are non-inverting. Because each input uses a CLB resource, replace functions with unused inputs with functions having the necessary number of inputs.

### Design Entry Method

This design element is only for use in schematics.

### For More Information

- See the [Spartan-3 User Guide](#).
- See the [Spartan-3 Data Sheets](#).

## XOR5

Primitive: 5-Input XOR Gate with Non-Inverted Inputs

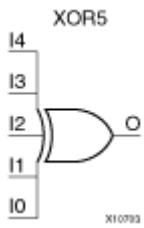

### Introduction

XOR functions of up to nine inputs are available. All inputs are non-inverting. Because each input uses a CLB resource, replace functions with unused inputs with functions having the necessary number of inputs.

### Design Entry Method

This design element is only for use in schematics.

### For More Information

- See the [Spartan-3 User Guide](#).
- See the [Spartan-3 Data Sheets](#).

## XOR6

Macro: 6-Input XOR Gate with Non-Inverted Inputs

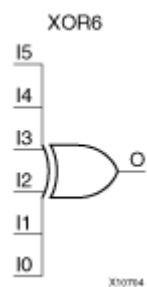

### Introduction

XOR functions of up to nine inputs are available. All inputs are non-inverting. Because each input uses a CLB resource, replace functions with unused inputs with functions having the necessary number of inputs.

### Design Entry Method

This design element is only for use in schematics.

### For More Information

- See the [Spartan-3 User Guide](#).
- See the [Spartan-3 Data Sheets](#).

## XOR7

Macro: 7-Input XOR Gate with Non-Inverted Inputs

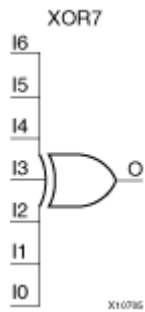

### Introduction

XOR functions of up to nine inputs are available. All inputs are non-inverting. Because each input uses a CLB resource, replace functions with unused inputs with functions having the necessary number of inputs.

### Design Entry Method

This design element is only for use in schematics.

### For More Information

- See the [Spartan-3 User Guide](#).
- See the [Spartan-3 Data Sheets](#).

## XOR8

Macro: 8-Input XOR Gate with Non-Inverted Inputs

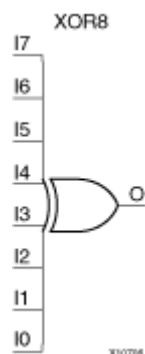

### Introduction

XOR functions of up to nine inputs are available. All inputs are non-inverting. Because each input uses a CLB resource, replace functions with unused inputs with functions having the necessary number of inputs.

### Design Entry Method

This design element is only for use in schematics.

### For More Information

- See the [Spartan-3 User Guide](#).
- See the [Spartan-3 Data Sheets](#).

## XOR9

Macro: 9-Input XOR Gate with Non-Inverted Inputs

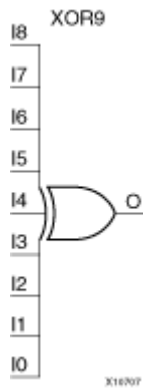

### Introduction

XOR functions of up to nine inputs are available. All inputs are non-inverting. Because each input uses a CLB resource, replace functions with unused inputs with functions having the necessary number of inputs.

### Design Entry Method

This design element is only for use in schematics.

### For More Information

- See the [Spartan-3 User Guide](#).
- See the [Spartan-3 Data Sheets](#).



## XORCY

Primitive: XOR for Carry Logic with General Output

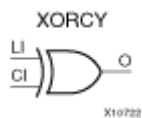

### Introduction

This design element is a special XOR with general O output that generates faster and smaller arithmetic functions. The XORCY primitive is a dedicated XOR function within the carry-chain logic of the slice. It allows for fast and efficient creation of arithmetic (add/subtract) or wide logic functions (large AND/OR gate).

### Logic Table

Input		Output
LI	CI	O
0	0	0
0	1	1
1	0	1
1	1	0

### Design Entry Method

This design element can be used in schematics.

### For More Information

- See the [Spartan-3 User Guide](#).
- See the [Spartan-3 Data Sheets](#).

## XORCY\_D

Primitive: XOR for Carry Logic with Dual Output

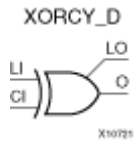

### Introduction

This design element is a special XOR that generates faster and smaller arithmetic functions.

### Logic Table

Input		Output
LI	CI	O and LO
0	0	0
0	1	1
1	0	1
1	1	0

### Design Entry Method

This design element can be used in schematics.

### For More Information

- See the [Spartan-3 User Guide](#).
- See the [Spartan-3 Data Sheets](#).

# XORCY\_L

Primitive: XOR for Carry Logic with Local Output

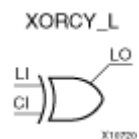

## Introduction

This design element is a special XOR with local LO output that generates faster and smaller arithmetic functions.

## Logic Table

Input		Output
LI	CI	LO
0	0	0
0	1	1
1	0	1
1	1	0

## Design Entry Method

This design element can be used in schematics.

## For More Information

- See the [Spartan-3 User Guide](#).
- See the [Spartan-3 Data Sheets](#).