



Xgate Co- Processor (xgate) Specification

Author: Robert Hayes
rehayes@opencores.org

Rev. 0.1
January 11, 2010

This page has been intentionally left blank.

Revision History

Rev.	Date	Author	Description
0.1	09/29/09	Robert Hayes	

Contents

INTRODUCTION	1
FEATURES	1
ARCHITECTURE.....	3
2.1 WISHBONE SLAVE INTERFACE.....	4
2.2 CONTROL REGISTERS.....	4
2.3 INTERRUPT INTERFACE	4
2.4 WISHBONE MASTER INTERFACE.....	5
2.5 RISC PROCESSOR CORE	5
OPERATION	10
3.1 SOFTWARE EXAMPLE.....	10
3.2 SOFTWARE TRIGGERS	11
3.3 SEMAPHORE BITS	11
3.4 PROGRAM MEMORY CONNECTION OPTIONS	11
3.5 DEBUG MODE.....	11
3.6 INSTRUCTION SET SUMMARY	11
3.7 INCONSISTENT INSTRUCTION SET DOCUMENTATION	11
REGISTERS.....	13
LIST OF REGISTERS.....	13
4.1 XGATE MODULE CONTROL REGISTER (XGMCTL).....	14
4.2 XGATE CHANNEL ID REGISTER (XGCHID).....	17
4.3 XGATE VECTOR BASE ADDRESS REGISTER (XGVBR).....	17
4.4 XGATE INTERRUPT FLAG REGISTER 7 (XGIFR_7).....	18
4.5 XGATE SOFTWARE TRIGGER REGISTER (XGSWT).....	18
4.6 XGATE SEMAPHORE REGISTER (XGSEM)	19
4.7 XGATE CONDITION CODE REGISTER (XGCCR).....	20
4.8 XGATE PROGRAM COUNTER REGISTER (XGPC)	20
4.6 XGATE REGISTER 1 (XGR1)	21
CLOCKS	22
IO PORTS.....	23
6.1 WISHBONE SLAVE INTERFACE.....	24
6.2 XGATE SIGNALS.....	26
6.3 XGATE CORE PARAMETERS.....	27
APPENDIX A	29
INDEX	103

1

Introduction

The Xgate Co-processor Module, Xgate, is a 16 bit programmable RISC processor that is managed by a host CPU to reduce the host load in handling interrupts. Because the Xgate is user programmable there is a great deal of user control in how to preprocess data from peripheral modules. This module may be configured as a simple DMA controller to organize data such that the host only operates with whole messages and not individual words or bytes. The Xgate may also handle higher levels of messaging protocols than the peripheral hardware recognizes. Encryption algorithms are also supported by the instruction set.

The ideal application for the Xgate co-processor is in an ASIC environment where a specific host processor is required but the host as a standalone processor lacks sufficient computational resources to service the target application. Such a situation might occur in an existing application that has an extensive software base or the host processor has a significant history in similar applications. In this environment the Xgate provides the additional resources needed for the application while also providing the user programmability that may allow the ASIC to be used in other applications.

The use of an Xgate co-processor in an FPGA may not be as advantageous as in an ASIC environment because of the reprogrammability of the FPGA hardware. Because the Xgate co-processor offers a generic solution to a variety of problems and the functionality can be changed by upgrading user software without changing the FPGA hardware implementation it may still be a valuable solution to certain problems. The use of the Xgate module may also reduce development time since the application can begin debug sooner and changes can be prototyped in user software.

FEATURES

- **Instruction set compatible with Freescale XGATE co-processor**
- **Handles up to 127 interrupt inputs**
- **Eight software triggerable interrupt channels.**
- **Eight semaphore registers to coordinate host/Xgate shared memory.**

- **Static synchronous design**
- **Fully synthesizable**

2

Architecture



The Xgate core is built around five primary blocks; the WISHBONE Slave Interface, WISHBONE Master Interface, the Control Registers, Interrupt Priority, and RISC Processor Core.

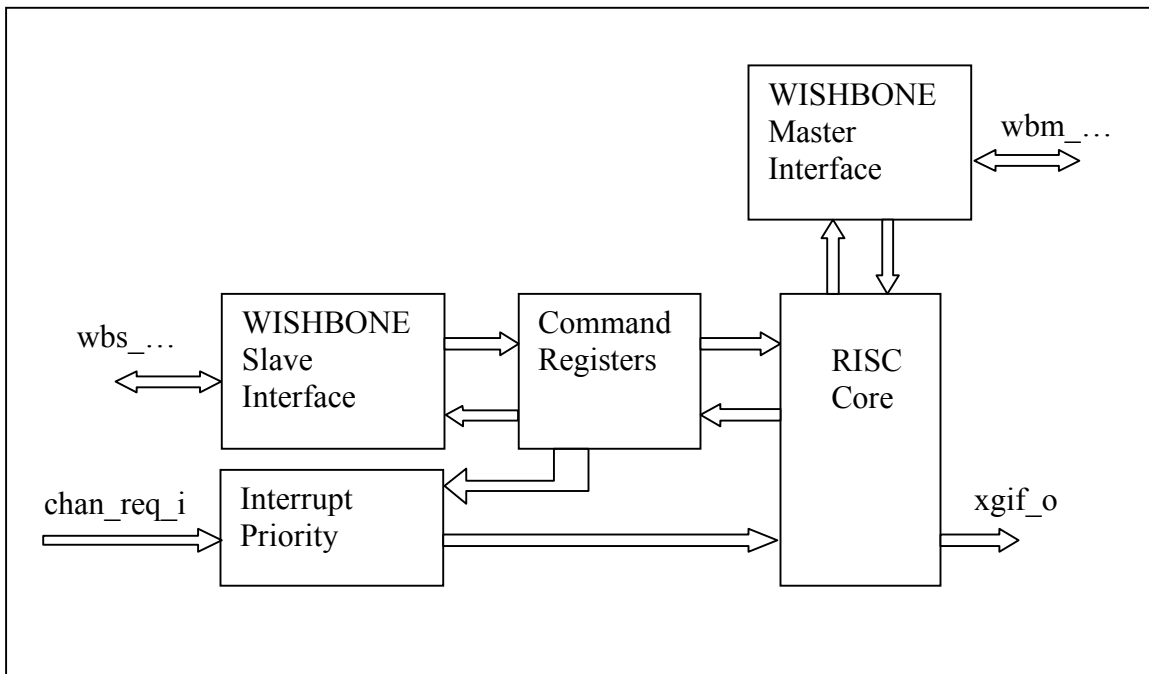

Fig. 2.1 Internal structure Xgate Core

2.1 WISHBONE Slave Interface

The host processor uses this bus to access the Xgate control and status registers. The WISHBONE Slave Interface isolates the Xgate functionality from the WISHBONE bus. This interface takes the bus specific signals and generates a generic set of control signals to drive the Xgate control registers. Isolating the WISHBONE bus should help promote Xgate module reusability by localizing the scope of changes needed to retarget the Xgate module to another bus environment.

2.2 Control Registers

This module receives the generic write signals from the WISHBONE Slave Interface and applies these signals to the registers that the host processor uses to control Xgate operation.

2.3 Interrupt Interface

The Interrupt Interface takes the input interrupts from other slave peripheral modules and prioritizes them for processing by the Xgate RISC Processor Core.

2.3.1 Simple Interrupt Interface

The current implementation uses the simplest interrupt interface with the least hardware and least functionality. This module takes the 127 interrupt inputs and does a simple encoding to generate the six bit bus that becomes the active channel select signal. The active interrupt input with the highest index number becomes the chosen channel select enable.

Because the Xgate module is in the signal path from the interrupt sources to the host CPU there must always be some code running in the Xgate module to activate the appropriate interrupt output to the CPU.

2.3.2 Bypass Interrupt Interface

This is a proposed functional improvement and is not currently implemented. This module will do the same basic interrupt encoding as the “Simple Interrupt Interface” except it will include the additional functionality to allow an interrupt input to be bypassed around the Xgate module and connected directly to the host CPU. This will eliminate the latency and software overhead when it is required for the host CPU to process some interrupts directly while still reserving the option to enable the Xgate module to preprocess those same interrupt sources at some other time. To implement this functionality additional control registers will need to be added to the WISHBONE slave interface.

2.3.3 Programmable Interrupt Interface

This is a proposed functional improvement and is not currently implemented. This module will include the functionality of the “Bypass Interrupt Interface” with additional functionality to allow interrupt priorities to be set by the host CPU. This will eliminate the latency and software overhead when it is required for the host CPU to process some interrupts directly while still reserving the option to enable the Xgate module to preprocess those same interrupt sources at some other time. To implement this functionality additional control registers will need to be added to the WISHBONE slave interface.

2.4 WISHBONE Master Interface

The Xgate module uses the WISHBONE Master Interface to access the shared memory space where it’s software code, data, and other slave peripheral registers may be accessed. The WISHBONE Master Interface isolates the Xgate functionality from the WISHBONE bus. This interface takes the bus specific signals and generates a generic set of control signals to drive the Xgate RISC Processor. Isolating the WISHBONE bus should help promote Xgate module reusability by localizing the scope of changes needed to retarget the Xgate module to another bus environment.

2.5 RISC Processor Core

The RISC Processor Core is the key element of the Xgate module. This module implements the Xgate instruction set.

2.5.1 Hardware Model



2.5.2 State Machine

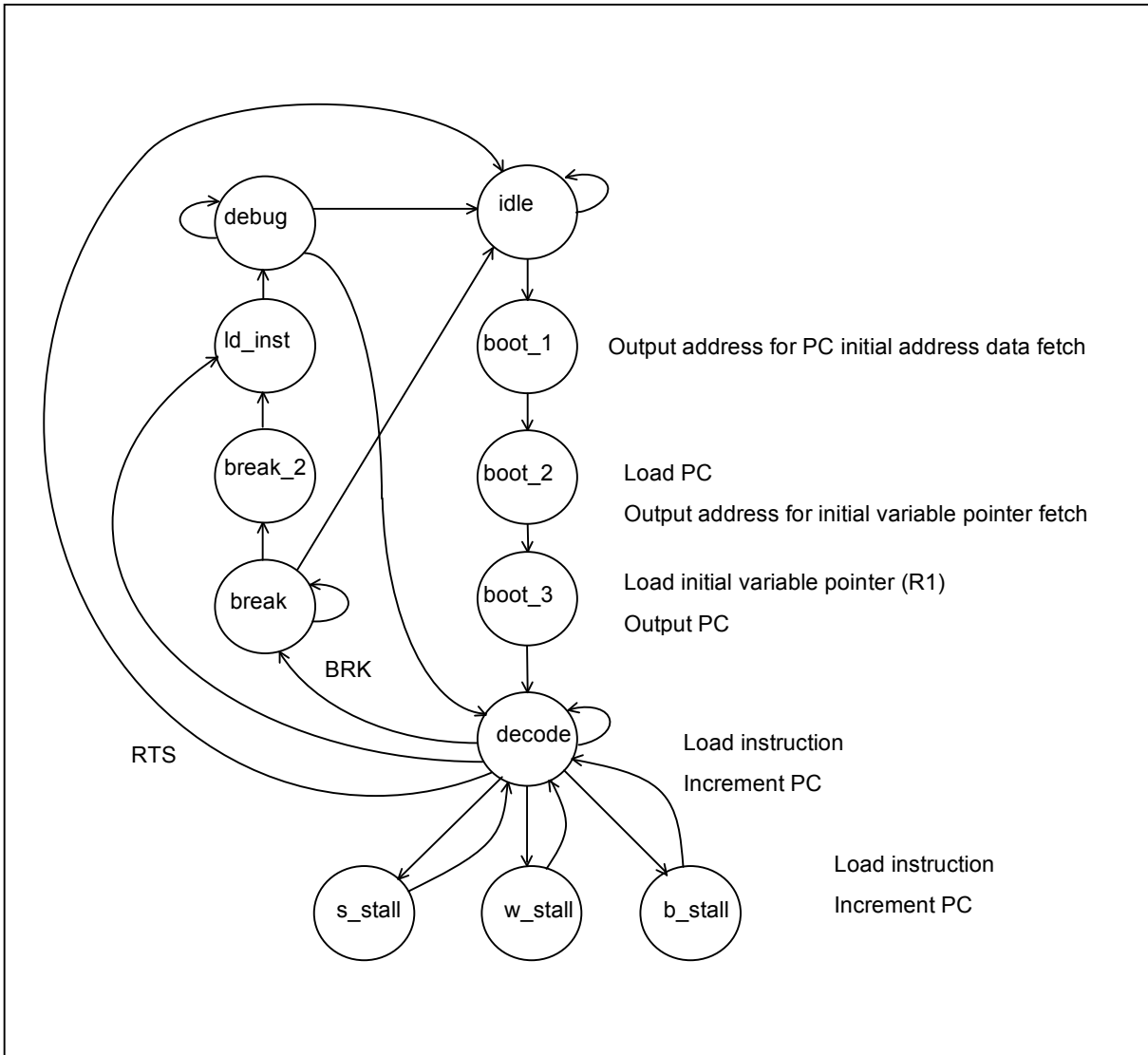

Idle: The idle state is the condition where the xgate RISC processor waits to be enabled and an interrupt input to be activated.

Boot_1: State entered after an input interrupt is detected. Output the address stored in $XGVBR + 2 * XGCHID$ to fetch PC (Program Counter).

Boot_2: State entered after Boot_1. Load the PC and output the address of the variable pointer, $XGVBR + 2 * XGCHID + 2$.

Boot_3: State entered after Boot_2. Load the variable pointer. Output the PC and prepare to load the first instruction.

Decode: In normal user operation this is the state entered after Boot_3 and the instruction is decoded and executed. For single cycle instructions, if Debug Mode is not active, then the Program Counter is incremented and the next instruction is loaded. For multi-cycle instructions one of the three instruction continue states is selected. If an RTS instruction is decoded then the state machine is returned to the Idle state to wait for the next change in XGCHID.

S_stall: Simple stall is the state that branch instructions use to change the PC when a change of flow is required. This state is also used for Store instructions.

W_stall: Word stall is the state Load instructions use to retrieve a word of RAM memory data.

B_stall: Byte stall is the state Load instructions use to retrieve a byte of RAM memory data.

Break: If the Decode state detects a BRK command then the Break state is entered. The RISC processor remains in the Break state till:

Single Step Command

XGEN is set to zero

XGCHID is set to zero

Break_2: After a Single Step Command is issued in the Break state the PC is incremented in this state.

Ld_inst: The Load Instruction state is used in debug mode to load the next instruction to be executed into the RISC instruction register.

Debug: debug is the state where the RISC processor waits for an input to execute the next command Exit conditions for this state are:

Single Step Command

XGEN is set to zero

XGCHID is set to zero

2.5.3 Semaphore Bits

Each semaphore bit is a simple state machine that is controlled by write commands from either the host or RISC processor. The first write command to set a semaphore bit takes control of the semaphore state until the bit is cleared by the setting processor. The host has priority if the host and RISC processor attempt to write the semaphore bit in the same clock cycle. Each processor has a different read view of the semaphore bit so it can determine if it has successfully set the bit.

```
// Semaphore states  
NO_LOCK = 2'b00  
RISC_LOCK = 2'b10  
HOST_LOCK = 2'b11
```

These are the states for the semaphore bits. Only three of the four possible states are required to cover all the real things that can happen. For decoding the state of a semaphore bit the MSB is equivalent to "locked" and the LSB is equivalent to which processor is the one that owns the lock. Therefore state 2'b01 doesn't make sense because it implies there is no "lock" but the bit is owned by the host. In terms of the actual logic it probably makes little if any difference how the states are encoded but from the mental perspective it maybe helpful in understanding and debug to have the individual bits of the state be connected to a unique meaning.

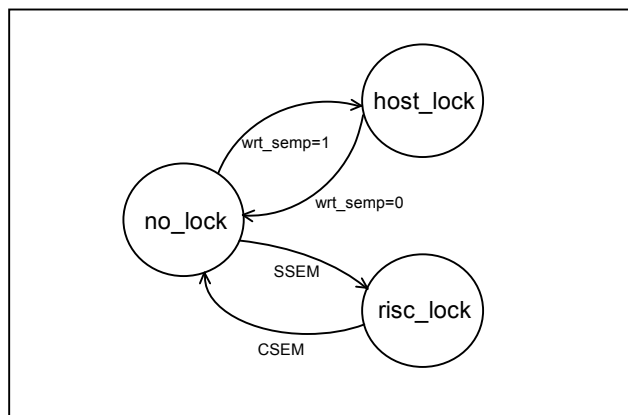

3

Operation

The Xgate Module is a simple RISC CPU with an instruction set that is compatible with the Freescale XGATE module.

The COP module also has the capability to generate an interrupt at a programmed number of cycles before the `cop_rst_o` initiates a system reset. This functionality is primarily intended as a debug feature.

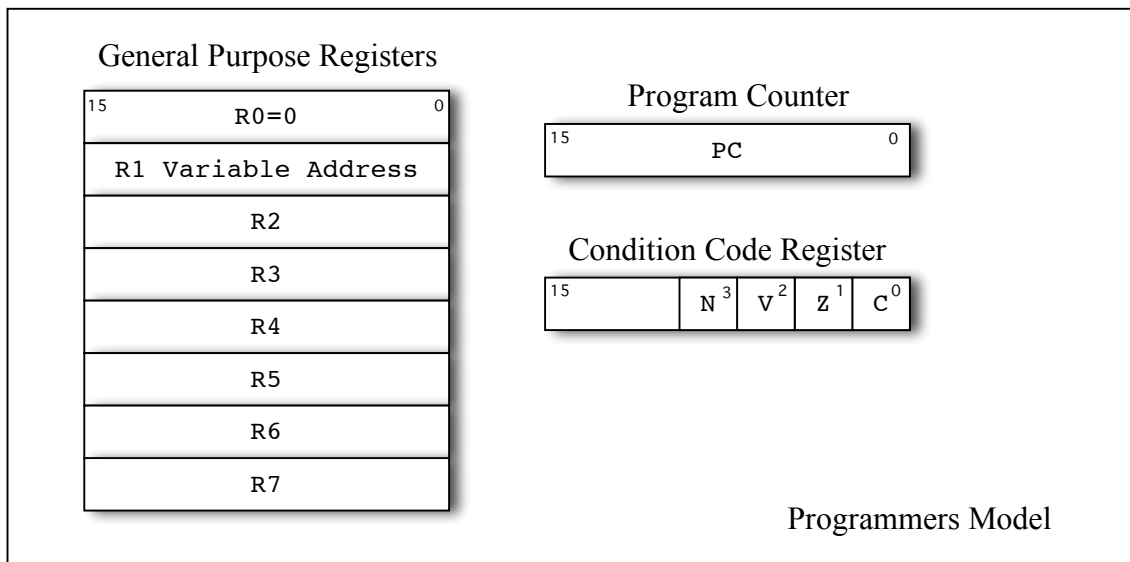

3.1 Software Example

The recommended software procedure for using the Xgate Module:

1. Initialize Xgate
 - a) Load RAM with Xgate software.
 - b) Set XGVBR register to base address of input interrupt vectors.
 - c) Enable Xgate by setting the XGE bit.

- d) Enable host to accept interrupts.
 - e) Enable peripheral modules to output interrupts as required.
2. Normal Operation
- a) Service Xgate interrupt requests as they are received by the host.

3.2 Software Triggers

3.3 Semaphore Bits

3.4 Program Memory Connection Options

3.5 Debug Mode

3.6 Instruction Set Summary

The RISC Processor Core is the key element of the Xgate module. This module implements the Xgate instruction set.

Function	15	14	13	12	11	10	9	8	7	6	5	4	3	2	1	0
Return to Scheduler and other																
BRK	0	0	0	0	0	0	0	0	0	0	0	0	0	0	0	0
NOP	0	0	0	0	0	0	0	1	0	0	0	0	0	0	0	0

3.7 Inconsistent Instruction Set Documentation

The following instructions have problems in the Freescale documentation.

3.7.1 *SUBL*

Freescale Documentation:

Z:

V: Set if a two's complement overflow resulted from the 8-bit operation; cleared otherwise.

RD[15]_{old} & IRD[15]_{new}

C: Set if there is a carry from the bit 7 to bit 8 of the result; cleared otherwise.

!RD[15]_{old} & RD[15]_{new}

Xgate implementation:

For signed subtraction the rules for overflow are:

Negative number minus Positive number creates a Positive number OR

Positive number minus Negative number creates a Negative number

So the overflow calculation should be:

$$V = RD[7] \& !IMM8[7] \& !result[7] \mid !RD[7] \& IMM8[7] \& result[7]$$

The Carry calculation should be:

$$C = !RD[7] \& IMM8[7] \mid !RD[7] \& result[7] \mid IMM8[7] \& result[7]$$

These calculations for setting the Carry and Overflow bits are also consistent with the calculations used to set the Carry and Overflow bits using the CMPL instruction.

3.7.2 ADDL

Freescale Documentation:

V: Set if a two's complement overflow resulted from the 8-bit operation; cleared otherwise.

RD[15]_{old} & RD[15]_{new}

C: Set if there is a carry from the bit 7 to bit 8 of the result; cleared otherwise.

RD[15]_{old} & RD[15]_{new}

Xgate implementation:

For signed addition the rules for overflow are:

Positive number plus Positive number creates a Negative number OR

Negative number plus Negative number creates a Positive number

So the overflow calculation should be:

$$V = !RD[7] \& !IMM8[7] \& result[7] \mid RD[7] \& IMM8[7] \& !result[7]$$

The Carry calculation should be:

$$C = !RD[7] \& IMM8[7] \mid RD[7] \& !result[7] \mid IMM8[7] \& !result[7]$$

3.7.2 SUBH

Freescale Documentation:

Z = ????

4

Registers

The Xgate Module has a WISHBONE bus interface configured for a 16-bit bus width with 8-bit granularity.

List of Registers

Name	Address	Width	Access	Description
XGMCTL	0x00	16	RW	Xgate Module Control Register
XGCHID	0x02	16	RW	Xgate Channel ID Register
	0x04	16	RW	Reserved
	0x06	16	RW	Reserved
XGVBR	0x08	16	RW	Xgate Vector Base Address
XGIF_7	0x0A	16	RW	Xgate Interrupt Flag Register #7
XGIF_6	0x0C	16	RW	Xgate Interrupt Flag Register #6
XGIF_5	0x0E	16	RW	Xgate Interrupt Flag Register #5
XGIF_4	0x10	16	RW	Xgate Interrupt Flag Register #4
XGIF_3	0x12	16	RW	Xgate Interrupt Flag Register #3
XGIF_2	0x14	16	RW	Xgate Interrupt Flag Register #2
XGIF_1	0x16	16	RW	Xgate Interrupt Flag Register #1
XGIF_0	0x18	16	RW	Xgate Interrupt Flag Register #0
XGSWT	0x1A	16	RW	Xgate Software Trigger Register
XGSEM	0x1C	16	RW	Xgate Semaphore Register
	0x1E	16	R	Reserved
XGCCR	0x20	16	RW	Xgate Condition Code Register
XGPC	0x22	16	RW	Xgate Program Counter
	0x24	16	R	Reserved

Name	Address	Width	Access	Description
XGR1	0x26	16	RW	Xgate Register 1
XGR2	0x28	16	RW	Xgate Register 2
XGR3	0x2A	16	RW	Xgate Register 3
XGR4	0x2C	16	RW	Xgate Register 4
XGR5	0x2E	16	RW	Xgate Register 5
XGR6	0x30	16	RW	Xgate Register 6
XGR7	0x32	16	RW	Xgate Register 7

Table 1: List of registers

4.1 Xgate Module Control Register (XGMCTL)

Note: The XGMCTL register can only be written using a word(16 bit) access.

Bit #	Access	Description
15	W	XGEM, XGE Mask – The XGE bit can only be changed when the XGEM bit is set in the same register access. ‘0’ No change allowed to XGE control bit. ‘1’ Change allowed to XGE control bit. Always reads as ‘0’.
14	W	XGFRZM, XGFRZ Mask – The XGFRZ bit can only be changed when the XGEM bit is set in the same register access. ‘0’ No change allowed to XGFRZ control bit. ‘1’ Change allowed XGFRZ control bit. Always reads as ‘0’.
13	W	XGDGBM, XGDGB Mask – The XGDGB bit can only be changed when the XGDGBM bit is set in the same register access. ‘0’ No change allowed to XGDBG control bit. ‘1’ Change allowed to XGDBG Control bit. Always reads as ‘0’.
12	W	XGSSM, XGSS Mask – The XGSS bit can only be changed when the XGSSM bit is set in the same register access.

Bit #	Access	Description
		'0' No change allowed to XGSS control bit. '1' Change allowed to XGSS control bit. Always reads as '0'.
11	W	XGFACTM, XGFACT Mask – The XGFACT bit can only be changed when the XGFACTM bit is set in the same register access. '0' No change allowed to XGFACT control bit. '1' Change allowed to XGFACT control bit. Always reads as '0'.
10		BRK_IRQ_ENM, BRK_IRQ_EN Mask – The BRK_IRQ_EN bit can only be changed when the BRK_IRQ_ENM bit is set in the same register access. '0' No change allowed to BRK_IRQ_EN control bit. '1' Change allowed to BRK_IRQ_EN control bit. Always reads as '0'.
9	RW	XGSWEIFM, XGSWEIF Mask – The XGSWEIF bit can only be changed when the XGSWEIFM bit is set in the same register access. '0' No change allowed to XGSWEIF control bit. '1' Change allowed to XGSWEIF control bit. Always reads as '0'.
8	RW	XGIEM, XGIE Mask – The XGIE bit can only be changed when the XGIEM bit is set in the same register access. '0' No change allowed to XGIE control bit. '1' Change allowed to XGIE control bit. Always reads as '0'.
7	RW	XGE, XG Enable – The XGE bit can only be changed when the XGEM bit is set in the same register access. '0' The Xgate module is disabled. The currently active interrupt request will be completed and then no new interrupt processing requests will be accepted. '1' The Xgate module is enabled to start processing channel interrupts.
6	RW	XGFRZ, XG Freeze Mode – The XGFRZ bit functionality is currently unimplemented. This bit can only be changed when the XGFRZM bit is set in the same register access.

Bit #	Access	Description
		'0' The XGFRZ register bit is clear. '1' The XGFRZ register bit is set.
5	RW	XGDBG, XG Debug Mode – The XGDBG bit can only be changed when the XGDBGM bit is set in the same register access. '0' The Xgate module is not in DEBUG Mode. '1' The Xgate module is in DEBUG Mode. Along with writing to the XGDBG bit from the host interface DEBUG Mode can also be entered by executing the 'BRK' instruction by the RISC Processor Core.
4	RW	XGSS, XG Single Step – The XGSS bit can only be changed when the XGSSM bit is set in the same register access. '0' The Xgate module is disabled. The currently active channel interrupt will be completed and then no new interrupt channel processing requests will be accepted. '1' Write - Xgate module should execute a single RISC instruction. Read – A RISC instruction is being processed.
3	RW	XGFACT, XG Fake Activity – The XGFACT bit functionality is currently unimplemented. This bit can only be changed when the XGFACTM bit is set in the same register access. '0' The XGFACT bit is clear. '1' The XGFACT is set.
2	RW	BRK_IRQ_EN, Break Interrupt Enable – The BRK_IRQ_EN bit can only be changed when the BRK_IRQ_EN M bit is set in the same register access. '0' The Xgate module is operating in a mode compatible with the Freescale XGATE module. BRK instructions do not generate an Xgate error interrupt output. '1' The Xgate module is enabled to output an error interrupt whenever a BRK command is encountered. Set this bit whenever no BRK commands are expected to be used in the software.
1	RW	XGSWEIF, XG Software Error Interrupt Flag – The XGSWEIF bit can only be changed when the XGSWEIFM bit is set in the same register access. '0' The Xgate module is operating correctly. Writing '0' has no effect. '1' The Xgate RISC processor has detected an error condition. Writing '1' will clear a set XGSWEIF bit and terminate the

Bit #	Access	Description
		current interrupt process. The Xgate module will go to an IDLE state if no other interrupt inputs are active.
0	RW	XGIE, XG Interrupt Enable – The XGIE bit can only be changed when the XGEM bit is set in the same register access. ‘0’ All Xgate module interrupt outputs are disabled. ‘1’ All Xgate module interrupt outputs are enabled.

Reset Value:

XGMCTL: 0004h

Table 2: CNTRL Register Bits

4.2 Xgate Channel ID Register (XGCHID)

Bit #	Access	Description
15:7	R	Reserved, write zeros for future compatibility.
6:0	RW	XGCHID, XG Channel ID – The XGCHID register reflects the value of the current interrupt channel being processed. ‘0’ No interrupt currently being processed. ‘1’ The encoded value of the input interrupt currently being processed. The XGCHID can only be written in DEBUG Mode. When a value is written to the XGCHID register the RISC Processor Core will start executing the code associated with that interrupt input.

Reset Value:

XGCHID: 0000h

Table 4: Channel ID Register Bits

4.3 Xgate Vector Base Address Register (XGVBR)

Bit #	Access	Description
15:1	RW	XGVBR, Sets the vector base address that the Xgate RISC Core uses to determine where in the memory map the code and data space is for a specific interrupt is reserved. XGVBR can only be changed when XGE is zero.

Reset Value:

XGVBR: FE00h

Table 5: XGVBR Register Bits

4.4 Xgate Interrupt Flag Register 7 (XGIFR_7)

The bits in this register reflect the state of interrupts that are being output from the Xgate module to the host CPU. A bit is set by the Xgate module with the “SIF” instruction usually at the end of a process and the host CPU clears the XGIF bit as part of its interrupt service routine.

Clear the interrupt output by writing a ‘1’ to the corresponding XGIF register bit.

The highest numbered interrupt is in the MSB position of the register bank.

Some bits in this register may be unimplemented in a specific hardware design based on the setting of the “MAX_CHANNEL” parameter and will always read as “0”.

Bit #	Access	Description
15:0	RW	XGIF_127 – XGIF_112 ‘0’ No interrupt. ‘1’ Interrupt output active.

Reset Value:

XGIFR_7: 0000h

Table 5: XGIF_7 Register Bits

4.5 Xgate Software Trigger Register (XGSWT)

Note: The XGSWT register can only be written using a word(16 bit) access.

Bit #	Access	Description
15:8	W	XGSWTM[7:0], Read always returns zero. XGSWTM, XGSWT Mask – The XGSWT bits can only be changed when the XGSWTM bit is set in the same register access.

Bit #	Access	Description
		'0' No change allowed to XGSWT control bit. '1' Change allowed to XGSWT control bit. Always reads as '0'.
7:0	RW	XGSWT[7:0], XG Software Trigger – XGSWT bits can only be changed when the corresponding XGSWTM bit is set in the same register access. '0' The task associated with the XGSWT is disabled. '1' The task associated with the XGSWT bit is queued to start processing when it becomes the highest priority Xgate interrupt input.

Reset Value:

XGSWT: 0000h

Table 5: XGSWT Register Bits

4.6 Xgate Semaphore Register (XGSEM)

Note: The XGSEM register can only be written using a word(16 bit) access.

Bit #	Access	Description
15:8	W	XGSEMM, XGSEM Mask – The XGSEM bit can only be changed when the XGSEMM bit is set in the same register access. '0' No change allowed to XGSEM control bit. '1' Change allowed to XGSEM control bit. Always reads as '0'.
7:0	RW	XGSWT[7:0], XG Software Trigger – The XGSWT bit can only be changed when the XGSWTM bit is set in the same register access. '0' The semaphore bit is either unlocked or locked by the Xgate module. If the host attempts to set the bit by writing a '1' and a subsequent read of the bit returns a '0' the bit is locked by the Xgate module. '1' The semaphore bit is locked by the host processor. The host writes a '0' to clear the bit and unlock the semaphore.

Reset Value:

XGSEM: 0000h

Table 5: XGSEM Register Bits

4.7 Xgate Condition Code Register (XGCCR)

Note: The XGCCR register can only be written when DEBUG mode is active or the XGE bit is clear.

Bit #	Access	Description
15:4	R	Reserved, write zeros for future compatibility.
3	RW	XGN, Xgate Negative – Reflects the current state of the “Negative” bit of the Xgate condition code register.
2	RW	XGZ, Xgate Zero – Reflects the current state of the “Zero” bit of the Xgate condition code register.
1	RW	XGV, Xgate Overflow – Reflects the current state of the “Overflow” bit of the Xgate condition code register.
0	RW	XGC, Xgate Carry – Reflects the current state of the “Carry” bit of the Xgate condition code register.

Reset Value:

XGCCR: 0000h

Table 5: XGCCR Register Bits

4.8 Xgate Program Counter Register (XGPC)

Note: The XGPC register can only be written when DEBUG mode is active or the XGE bit is clear.

Bit #	Access	Description
15:0	RW	XGPC, Read returns the current state of the Xgate Program Counter. Writes to the XGPC register can only be done in Debug Mode.

Reset Value:

XGPC: 0000h

Table 5: XGPC Register Bits

4.6 Xgate Register 1 (XGR1)

Note: The XGR1 register can only be written when DEBUG mode is active or the XGE bit is clear.

Bit #	Access	Description
15:0	RW	XGR1, Read returns the current state of the Xgate General Purpose Register 1. Writes to the XGR1 register can only be done in Debug Mode.

Reset Value:

XGR1: 0000h

Table 5: XGR1 Register Bits

5

Clocks

Name	Source	Rates (MHz)			Remarks	Description
		Max	Min	Resolution		
wbs_clk_i	System	200	-	-	Master clock for all Xgate bus registers. Positive edge active.	System clock.
risc_clk_i	System					RISC Processor clock

Table 3: List of clocks

The wbs_clk_i has no timing constraints based on the RTL implementation although there may be constraints applied for synthesis results to be compatible with the target physical implementation. If the Xgate is targeted for an ASIC implementation then [wbs_clk_i] should be used as the scan clock, any clock multiplexing required to make [wbs_clk_i] the scan clock should be done at the system level external to the Xgate Module.

The risc_clk_i is the clock used to run the Xgate RISC processor submodule. The frequency of this clock should be the same as or 2X the frequency of the wbs_clk_i input. The risc_clk_i input is assumed to be in phase with the wbs_clk_i input.

6

IO Ports

Port	Width	Direction	Description
wbs_clk_i	1	Input	WISHBONE Bus Clock Input, Master Clock
wbs_rst_i	1	Input	WISHBONE Slave Synchronous Reset
wbs_adr_i	5	Input	WISHBONE Slave Lower address bits
wbs_dat_i	16	Input	WISHBONE Slave Bus Data
wbs_dat_o	16	Output	WISHBONE Slave Bus Data
wbs_we_i	1	Input	WISHBONE Slave Write enable
wbs_stb_i	1	Input	WISHBONE Slave Strobe signal/Core select
wbs_cyc_i	1	Input	WISHBONE Slave Valid bus cycle
wbs_sel_i	2	Input	WISHBONE Slave Data Bus Byte Select
wbs_ack_o	1	Output	WISHBONE Slave Bus cycle acknowledge
wbm_adr_o	16	Output	WISHBONE Master address bits
wbm_dat_i	16	Input	WISHBONE Master Bus Data
wbm_dat_o	16	Output	WISHBONE Master Bus Data
wbm_we_o	1	Output	WISHBONE Master Write enable
wbm_stb_o	1	Output	WISHBONE Master Strobe signal/Core select
wbm_cyc_o	1	Output	WISHBONE Master Valid bus cycle
wbm_sel_o	2	Output	WISHBONE Master Data Bus Byte Select
wbm_ack_i	1	Input	WISHBONE Master Bus cycle acknowledge

Port	Width	Direction	Description
arst_i	1	Input	Asynchronous Reset
risc_clk_i	1	Input	Clock signal for the RISC Core Processor
chan_req_i	127	Input	Xgate Interrupt Request
xgif_o	127	Output	Xgate Interrupt Request
xg_sw_irq	1	Output	Xgate Software Error Interrupt
xgswt	8	Output	Xgate Software Trigger
debug_mode_i	1	Input	Force Xgate into debug mode
secure_mode_i	1	Input	Limit host access to RISC core registers
scantestmode_i	1	Input	Scan Test Mode Enable

Table 4: List of IO ports

6.1 WISHBONE Slave Interface

The core features a WISHBONE RevB.3 compliant WISHBONE Classic interface that operates in SLAVE mode. All output signals are registered. Each access takes 2 clock cycles. To limit a WISHBONE access to just two clock cycles the following synthesis rules should be used:

- Single cycle timing for wbs_cyc_i and wbs_stb_i
- Two cycle timing for wbs_adr_i, wbs_data_i, and wbs_data_o. (Single cycle timing could be used but it would be a waste of resources to meet an over constrained timing path.)

Note: Use the "SINGLE_CYCLE" parameter to do a WISHBONE bus access in one clock cycle.

WISHBONE DATASHEET	
Description	Specification
General description:	16-bit SLAVE
Supported Cycles:	SLAVE, READ/WRITE

Data port, size: Data port, granularity: Data port, maximum operand size: Data transfer ordering: Data transfer sequencing:	16 bit word 8 bit byte	
Supported signal list and cross reference to equivalent WISHBONE signals:	Signal Name	WISHBONE Equiv.
	wbs_clk_i	CLK_I
	wbs_rst_i	RST_I
	wbs_adr_i	ADR_I()
	wbs_dat_i	DAT_I()
	wbs_dat_o	DAT_O()
	wbs_we_i	WE_I
	wbs_stb_i	STB_I
	wbs_cyc_i	CYC_I
	wbs_sel_i	SEL_I()
	wbs_ack_o	ACK_O

6.1.1 *wbs_rst_i*

The synchronous reset signal has a minimum pulse width requirement of one [wbs_clk_i] clock period. It will take two [wbs_clk_i] clock cycles for all registers in the Xgate Module to initialize. Also see information on pin [arst_i].

6.1.2 *wbs_adr_i*

The slave WISHBONE address pins are defined to be compatible with a WISHBONE bus that is word addressed and byte accessible. This means that there is no [wbs_adr_i[0]] input. If only word accesses are to be allowed then the LSB of the host address bus can be connected to [wbs_adr_i[1]].

6.1.3 *wbs_sel_i*

The [*wbs_sel_i*] are the WISHBONE byte lane select signals. These signals allow selected Xgate registers to be written in byte mode. Note that some registers can only be written in 16 bit word mode. If only word mode accesses are to be done then these signals should be tied hi.

6.2 Xgate signals

6.2.1 *xgif_o[127:0]*

The Xgate output signal. This output is the result of executing the SIF command by the Xgate RISC processor. The normal connection is to the interrupt inputs of the host processor.

6.2.2 *chan_req_i[127:0]*

These signals are the interrupt inputs from the peripheral modules that the Xgate services. The eight outputs of the *xgswt_o* bus may also connect to some subset these inputs.

6.2.3 *xgswt_o[7:0]*

The [*xgswt_o*] signal is active low. These signals are activated by the host processor writing to the XGSWT register. These signals are connected to a user selected subset of the [*chan_req_i*] inputs to trigger the Xgate coprocessor to execute a software routine associated with the selected XGSWT register bit. The host should respond to the setting of one of the [*xgif_o*] outputs by clearing the set bit in the XGSWT register. Priority of the software routine executed is determined by which [*chan_req_i*] input the [*xgswt_o*] signal is connected to.

6.2.4 *arst_i*

The signal [*arst_i*] is an asynchronous reset signal that goes to all flops in the COP. It is provided for FPGA implementations and test methodologies that require this function for initialization. Using [*arst_i*] instead of [*wb_rst_i*] can result in lower cell-usage and higher performance for a FPGAs implementation because the standard FPGA cell already provides a dedicated asynchronous reset path. Using [*wb_rst_i*] for an ASIC implementation might synthesize to a smaller module because smaller non_reset flops can be used. Use either [*arst_i*] or [*wb_rst_i*], tie the other to a negated state. The active level of [*arst_i*] is determined by the parameter ARST_LVL that defaults to active low.

6.2.6 *xg_sw_irq_o*

This output signal is activated whenever the Xgate is activated whenever the encounters a software error. These errors are:

1. Instruction error
2. Instruction Address error
3. Load/Store Word Address error

6.2.7 *risc_clk_i*

The [*risc_clk_i*] is the clock input signal used by the RISC core processor.

6.2.8 *debug_mode_i*

The [*debug_mode_i*] input can be used by an external source such as a debug module to force the Xgate RISC core processor into debug mode. The exact number of clock cycles between the [*debug_mode_i*] signal going active and the RISC core stopping instruction execution may vary between one and several clock cycles. If no external debug activation is required then the [*debug_mode_i*] signal should be tied low.

6.2.9 *secure_mode_i*

The [*secure_mode_i*] input is used to limit host read access to the RISC core registers for software security reasons. In an ASIC implementation this pin would be tied to a non-volatile memory bit that is only cleared when all of the Xgate program memory is also cleared. In an FPGA implementation the signal may be tied to a level consistent with the desired application security level. If no software security is required then the [*secure_mode_i*] signal should be tied low.

6.2.10 *scantestmode_i*

The [*scantestmode_i*] input is an optional signal used to put the module into scan test mode. When [*scantestmode_i*] is active the [*startup_osc_clk_i*] is replaced by the [*wb_clk_i*] clock so all register are clocked by a common clock source.

6.3 Xgate Core Parameters

Parameter	Type	Default	Description
ARST_LVL	Bit	1'b0	Asynchronous reset level

MAX_CHANNEL	Integer	127	Number of input an output interrupts
SINGLE_CYCLE	Bit	1'b0	WISHBONE wait state

6.3.1 ARST_LVL

The asynchronous reset level can be set to either active high (1'b1) or active low (1'b0).

Allowed values: 1'b0, 1'b1

6.3.2 MAX_CHANNEL

The maximum index value for `chan_req_i` and `xgif`.

Allowed values: any integer value between 1 and 127

6.3.3 SINGLE_CYCLE

The default operation of the Xgate WISHBONE bus interface is to insert one wait state by delaying the assertion of the `wb_ack_o` by one `wb_clk_i` period. Setting the `SINGLE_CYCLE` parameter generates the `wb_ack_o` combinatorially so a WISHBONE bus cycle can be completed in one `wb_clk_i` period.

Allowed values: 1'b0, 1'b1

Appendix A

Name

Instruction Set Details

ADC – Add with Carry

Function:

$$RS1 + RS2 + C \Rightarrow RD$$

Use binary addition to add RS1, RS2, and Carry and store the sum in the RD register.

Example:

```

                                ; Do 32 bit addition R7:R6 = R5:R4 + R3:R2
                                ; --- Add least significant 16 bit words
ADD   R6, R4, R2                ; R6 = R4 + R2
                                ; --- Add most significant 16 bit words
ADC   R7, R5, R3                ; R7 = R5 + R3 + C
    
```

CCR Effect:

N	Z	V	C
Δ	Δ	Δ	Δ

N: Set if bit 15 of the result is set, otherwise cleared.

Z: Set if the result register, RD, is all zero's and Z was set before the operation, otherwise cleared.

V: Set if there is a two's complement overflow, otherwise cleared.

$$(RS1[15] \& RS2[15] \& \sim RD[15]_{new}) \mid (\sim RS1[15] \& \sim RS2[15] \& RD[15]_{new})$$

C: Set if there is a carry from bit 15 of the result, otherwise cleared.

$$(RS1[15] \& RS2[15]) \mid (RS1[15] \& \sim RD[15]_{new}) \mid (RS2[15] \& \sim RD[15]_{new})$$

Code and Cycles

ASM Code	Address Mode	Machine Code								Cycles		
ADC RD,RS1,RS2	TRI	0	0	0	1	1	RD	RS1	RS2	1	1	P

ADD – Add without Carry

Function:

$RS1 + RS2 \Rightarrow RD$

Use binary addition to add RS1, RS2, and store the sum in the RD register.

Example:

```

                                ; Do 16 bit addition R6 = R4 + R2
ADD    R6, R4, R2    ; R6 = R4 + R2
    
```

CCR Effect:

N	Z	V	C
Δ	Δ	Δ	Δ

N: Set if bit 15 of the result is set, otherwise cleared.

Z: Set if the result register, RD, is all zero's, otherwise cleared.

V: Set if there is a two's complement overflow, otherwise cleared.

$$(RS1[15] \& RS2[15] \& \sim RD[15]_{new}) \mid (\sim RS1[15] \& \sim RS2[15] \& RD[15]_{new})$$

C: Set if there is a carry from bit 15 of the result, otherwise cleared.

$$(RS1[15] \& RS2[15]) \mid (RS1[15] \& \sim RD[15]_{new}) \mid (RS2[15] \& \sim RD[15]_{new})$$

Code and Cycles

ASM Code	Address Mode	Machine Code						Cycles				
ADD RD,RS1,RS2	TRI	0	0	0	1	1	RD	RS1	RS2	1	0	P

ADDH – Add Immediate 8-bit constant high byte

Function:

$RD + IMM8:\$00 \Rightarrow RD$

Use binary addition to add RD, and a signed 8-bit constant and store the sum in the high byte of the RD register.

Example:

```

ADDL R6, #LOWBYTE      ; --- Add 16 bit immediate
                        ; R6 = R6 + 8 bit immediate
ADDH R6, #HIGHBYTE    ; R6 = R6 + 16 bit immediate
    
```

CCR Effect:

N	Z	V	C
Δ	Δ	Δ	Δ

N: Set if bit 15 of the result is set, otherwise cleared.

Z: Set if the result register, RD, is all zero's, otherwise cleared.

V: Set if there is a two's complement overflow, otherwise cleared.

$$(RD[15]_{old} \& IMM8[7] \& \sim RD[15]_{new}) \mid (\sim RD[15] \& \sim IMM8[7] \& RD[15]_{new})$$

C: Set if there is a carry from bit 15 of the result, otherwise cleared.

$$(RD[15]_{old} \& IMM8[7]) \mid (RD[15]_{old} \& \sim RD[15]_{new}) \mid (IMM8[7] \& \sim RD[15]_{new})$$

Code and Cycles

ASM Code	Address Mode	Machine Code						Cycles	
ADDH RD,#IMM8	IMM8	1	1	1	0	1	RD	IMM8	P

ADDL – Add Immediate 8-bit constant low byte

Function:

$RD + \$00:IMM8 \Rightarrow RD$

Use binary addition to add RD, and an unsigned 8-bit constant and store the sum in the RD register.

Example:

```

ADDL R6, #LOWBYTE      ; --- Add 16 bit immediate
                        ; R6 = R6 + 8 bit immediate
ADDH R6, #HIGHBYTE    ; R6 = R6 + 16 bit immediate
    
```

CCR Effect:

N	Z	V	C
Δ	Δ	Δ	Δ

N: Set if bit 15 of the result is set, otherwise cleared.

Z: Set if the result register, RD, is all zero's, otherwise cleared.

V: Set if there is a two's complement overflow, otherwise cleared.

$$(\sim RD[7] \& \sim IMM8[7] \& RD[7]_{new}) \parallel (RD[7] \& IMM8[7] \& \sim RD[7]_{new})$$

C: Set if there is a carry from bit 7 to bit 8 of the result, otherwise cleared.

$$(\sim RD[7]_{old} \& IMM8[7]) \mid (RD[7] \& \sim RD[7]_{new}) \mid (\sim RD[7]_{new} \& IMM8[7])$$

Code and Cycles

ASM Code	Address Mode	Machine Code						Cycles	
ADDL RD,#IMM8	IMM8	1	1	1	0	0	RD	IMM8	P

AND – Logical AND

Function:

RS1 & RS2 => RD

Do a bit wise logical AND between the RS1 and RS2 registers and store the sum in the RD register.

Example:

```

                                ; Bitwise 16 bit AND operation
AND   R6, R4, R2   ; R6 = R4 & R2
AND   R6, R0, R2   ; R6 = $0000
AND   R0, R4, R2   ; Set CCR without storing result
    
```

CCR Effect:

N	Z	V	C
Δ	Δ	0	-

N: Set if bit 15 of the result is set, otherwise cleared.

Z: Set if the result register, RD, is all zero's, otherwise cleared.

V: Always cleared.

C: Not affected.

Code and Cycles

ASM Code	Address Mode	Machine Code								Cycles		
AND RD,RS1,RS2	TRI	0	0	0	1	0	RD	RS1	RS2	0	0	P

ANDH – Logical AND Immediate 8-bit constant high byte

Function:

RD.H & IMM8:\$FF => RD

Do a bit wise logical AND between the 8-bit constant and the high byte of the RD register and store the sum in the RD register. The low byte of the RD register is unaffected.

Example:

```
ANDH R6, #HIGHBYTE ; R6.H = R6.H & 8 bit immediate
```

CCR Effect:

N	Z	V	C
Δ	Δ	0	-

N: Set if bit 15 of the result is set, otherwise cleared.

Z: Set if the 8 bit result, is all zero's, otherwise cleared.

V: Always cleared.

C: Not affected.

Code and Cycles

ASM Code	Address Mode	Machine Code						Cycles	
ANDH RD,#IMM8	IMM8	1	0	0	0	1	RD	IMM8	P

ANDL – Logical AND Immediate 8-bit constant low byte

Function:

RD.L + \$FF:IMM8 => RD

Da a logical AND function between the 8-bit constant and the low byte of the RD register and store the result in the RD register. The high byte of the RD register is unchanged.

Example:

```
ANDL R6, #LOWBYTE ; R6.L = R6.L & 8 bit immediate
```

CCR Effect:

N	Z	V	C
Δ	Δ	0	-

N: Set if bit 7 of the result is set, otherwise cleared.

Z: Set if the 8 bit result is all zero's, otherwise cleared.

V: Always cleared.

C: Not affected.

Code and Cycles

ASM Code	Address Mode	Machine Code						Cycles	
ANDL RD,#IMM8	IMM8	1	0	0	0	0	RD	IMM8	P

ASR – Arithmetic Shift Right

Function:

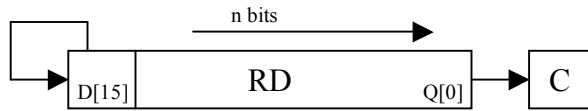

n = RS or IMM4

Use binary addition to add RS1, RS2, and Carry and store the sum in the RD register.

Example:

```
ASR R6, #3 ;
ASR R6, R1 ;
```

CCR Effect:

N	Z	V	C
Δ	Δ	0	Δ

N: Set if bit 15 of the result is set, otherwise cleared.

Z: Set if the result register, RD, is all zero's, otherwise cleared.

V: Always cleared.

C: Set if n > 0 and RD[n-1] = 1, if n = 0 then unaffected.

Code and Cycles

ASM Code	Address Mode	Machine Code										Cycles	
ASR RD,#IMM4	IMM4	0	0	0	0	1	RD	IMM4	1	0	0	1	P
ASR RD,RS	DYA	0	0	0	0	1	RD	RS	1	0	0	1	P

BCC – Branch if Carry Cleared

Function:

If $C = 0$ then $PC + \$0002 + (REL9 \ll 1) \Rightarrow PC$

Tests if the Carry Flag and branches if $C = 0$.

Example:

```

        BCC    CARRY_C    ;
        ;... Carry Set Code
    CARRY_C
        ;... Carry Clear Code
    
```

CCR Effect:

N	Z	V	C
-	-	-	-

N: Not affected.

Z: Not affected.

V: Not affected.

C: Not affected.

Code and Cycles

ASM Code	Address Mode	Machine Code							Cycles	
BCC REL9	REL9	0	0	1	0	0	0	0	REL9	PP/P

BCS – Branch if Carry Set

Function:

If $C = 1$ then $PC + \$0002 + (REL9 \ll 1) \Rightarrow PC$

Tests if the Carry Flag and branches if $C = 1$.

Example:

```

        BCS    CARRY_S    ;
        ;... Carry Clear Code
    CARRY_S
        ;... Carry Set Code
    
```

CCR Effect:

N	Z	V	C
-	-	-	-

N: Not affected.

Z: Not affected.

V: Not affected.

C: Not affected.

Code and Cycles

ASM Code	Address Mode	Machine Code								Cycles	
BCS REL9	REL9	0	0	1	0	0	0	0	1	REL9	PP/P

BEQ – Branch if Equal

Function:

If $Z = 1$ then $PC + \$0002 + (REL9 \ll 1) \Rightarrow PC$

Tests if the Zero Flag and branches if $Z = 1$.

Example:

```

TST    R1, R2
BEQ    A_EQ_B      ;
;... Not equal Code
A_EQ_B
;... Equal Code
    
```

CCR Effect:

N	Z	V	C
-	-	-	-

N: Not affected.

Z: Not affected.

V: Not affected.

C: Not affected.

Code and Cycles

ASM Code	Address Mode	Machine Code								Cycles
BEQ REL9	REL9	0	0	1	0	0	1	1	REL9	PP/P

BFEXT – Bit Field Extract

Function:

$RS1[(offset+width):offset] \Rightarrow RD[width:0]; 0 \Rightarrow RD[15:width+1]$

$width=(RS2[7:4])$

$offset=(RS2[3:0])$

Extracts (width+1) bits from register RS1 starting at index offset and writes them right aligned to register RD. The remaining bits of RD are cleared. If (offset+width)>15 only bits with index [15:offset] get extracted.

Example:

```

                                ; Do 32 bit addition R7:R6 = R5:R4 + R3:R2
                                ; --- Add least significant 16 bit words
ADD   R6, R4, R2                ; R6 = R4 + R2
                                ; --- Add most significant 16 bit words
ADC   R7, R5, R3                ; R7 = R5 + R3 + C
    
```

CCR Effect:

N	Z	V	C
Δ	Δ	0	-

N: Set if bit 15 of the result is set, otherwise cleared.

Z: Set if the result register, RD, is all zero's, otherwise cleared.

V: Always cleared.

C: Not effected.

Code and Cycles

ASM Code	Address Mode	Machine Code						Cycles				
BFEXT RD,RS1,RS2	TRI	0	1	1	0	0	RD	RS1	RS2	1	1	P

BFFO – Bit Field Find First One

Function:

FirstOne (RS) => RD;

Searches for the index of the most significant “1” in the RS register and puts that index into the RD register. The MSB’s of RD are cleared. If RS is \$0000 then RD will be set to \$0000 and the carry bit will be set. If the only “1” in RS is at index 0 then RD will be set to \$0000 and the carry flag will be cleared.

Example:

```

                                ; Find MSB of R2
    BFFO  R3, R2                 ; R3 = Index of R2 MSB
                                ; --- Branch if R2 was $0000
    BCS   NO_ONES               ; R2 had no set bits
    
```

CCR Effect:

N	Z	V	C
0	Δ	0	Δ

N: Always cleared.

Z: Set if the result register, RD, is all zero’s, otherwise cleared.

V: Always cleared.

C: Set if RS is \$0000, otherwise cleared.

Code and Cycles

ASM Code	Address Mode	Machine Code										Cycles		
		0	0	0	0	1	RD	RS	1	0	0		0	0
BFFO RD,RS	DYA	0	0	0	0	1	RD	RS	1	0	0	0	0	P

BFINS – Bit Field Insert

Function:

RS1[width:0] => RD[width+offset:offset]

width=(RS2[7:4])

offset=(RS2[3:0])

Extracts (width+1) bits from register RS1 starting at index 0 and writes them right into register RD at position offset. The remaining bits of RD are not effected. If (offset+width)>15 the upper bit are ignored. If R0 is used as RS1 then a bit field can be cleared.

Example:

```

                                ; Do 32 bit addition R7:R6 = R5:R4 + R3:R2
                                ; --- Add least significant 16 bit words
ADD    R6, R4, R2    ; R6 = R4 + R2
                                ; --- Add most significant 16 bit words
ADC    R7, R5, R3    ; R7 = R5 + R3 + C
    
```

CCR Effect:

N	Z	V	C
Δ	Δ	0	-

N: Set if bit 15 of the result is set, otherwise cleared.

Z: Set if the result register, RD, is all zero's, otherwise cleared.

V: Always cleared.

C: Not effected.

Code and Cycles

ASM Code	Address Mode	Machine Code						Cycles				
BFINS RD,RS1,RS2	TRI	0	1	1	0	1	RD	RS1	RS2	1	1	P

BFINSI – Bit Field Insert and Invert

Function:

\sim RS1[width:0] => RD[width+offset:offset]

width=(RS2[7:4])

offset=(RS2[3:0])

Extracts (width+1) bits from register RS1 starting at index 0, invert them, and then writes the result into register RD at position offset. The remaining bits of RD are not effected. If (offset+width)>15 the upper bit are ignored. If R0 is used as RS1 then a bit field can be set.

Example:

```

                                ; Do 32 bit addition R7:R6 = R5:R4 + R3:R2
                                ; --- Add least significant 16 bit words
ADD    R6, R4, R2                ; R6 = R4 + R2
                                ; --- Add most significant 16 bit words
ADC    R7, R5, R3                ; R7 = R5 + R3 + C
    
```

CCR Effect:

N	Z	V	C
Δ	Δ	0	-

N: Set if bit 15 of the result is set, otherwise cleared.

Z: Set if the result register, RD, is all zero's, otherwise cleared.

V: Always cleared.

C: Not effected.

Code and Cycles

ASM Code	Address Mode	Machine Code						Cycles				
		0	1	1	1	0	RD	RS1	RS2	1	1	P
BFINSI RD,RS1,RS2	TRI	0	1	1	1	0	RD	RS1	RS2	1	1	P

BFINSX – Bit Field Insert and XNOR

Function:

$$(\sim RS1[\text{width}:0] \wedge RD[\text{width}+\text{offset}:\text{offset}]) \Rightarrow RD[\text{width}+\text{offset}:\text{offset}]$$

$$\text{width}=(RS2[7:4])$$

$$\text{offset}=(RS2[3:0])$$

Extracts (width+1) bits from register RS1 starting at index 0, performs an XNOR with them and the bits of RD[width+offset:offset], and then writes the result into register RD at position offset. If R0 is used as RS1 then a bit field can be toggled.

Example:

```

                                ; Do 32 bit addition R7:R6 = R5:R4 + R3:R2
                                ; --- Add least significant 16 bit words
ADD    R6, R4, R2                ; R6 = R4 + R2
                                ; --- Add most significant 16 bit words
ADC    R7, R5, R3                ; R7 = R5 + R3 + C
    
```

CCR Effect:

N	Z	V	C
Δ	Δ	0	-

N: Set if bit 15 of the result is set, otherwise cleared.

Z: Set if the result register, RD, is all zero's, otherwise cleared.

V: Always cleared.

C: Not effected.

Code and Cycles

ASM Code	Address Mode	Machine Code								Cycles		
BFINSX RD,RS1,RS2	TRI	0	1	1	1	1	RD	RS1	RS2	1	1	P

BGE – Branch if Greater Than or Equal to Zero

Function:

If $N \wedge V = 0$ then $PC + \$0002 + (REL9 \ll 1) \Rightarrow PC$

Branch instruction to compare signed numbers.

Example:

```

                                ; Branch if RS1 GTE RS2
SUB    R0, R1, R2    ;
BGE    REL9
    
```

CCR Effect:

N	Z	V	C
-	-	-	-

N: Not affected.

Z: Not affected.

V: Not affected.

C: Not affected.

Code and Cycles

ASM Code	Address Mode	Machine Code								Cycles
BGE REL9	REL9	0	0	1	1	0	1	0	REL9	PP/P

BGT – Branch if Greater than Zero

Function:

If $Z \mid (N \wedge V) = 0$ then $PC + \$0002 + (REL9 \ll 1) \Rightarrow PC$

Branch instruction to compare signed numbers.

Example:

```

                                ; Branch if RS1 GT RS2
SUB    R0, R1, R2 ;
BGT    REL9
    
```

CCR Effect:

N	Z	V	C
-	-	-	-

N: Not affected.

Z: Not affected.

V: Not affected.

C: Not affected.

Code and Cycles

ASM Code	Address Mode	Machine Code								Cycles
BGT REL9	REL9	0	0	1	1	1	0	0	REL9	PP/P

BHI – Branch if Higher

Function:

If $C \mid Z = 0$ then $PC + \$0002 + (REL9 \ll 1) \Rightarrow PC$

Branch instruction to compare unsigned numbers.

Example:

```

                                ; Branch if RS1 GT RS2
SUB    R0, R1, R2    ;
BHI    REL9
    
```

CCR Effect:

N	Z	V	C
-	-	-	-

N: Not affected.

Z: Not affected.

V: Not affected.

C: Not affected.

Code and Cycles

ASM Code	Address Mode	Machine Code							Cycles	
BHI REL9	REL9	0	0	1	1	0	0	0	REL9	PP/P

BHS – Branch if Higher or Same

Function:

If C = 0 then PC + \$0002 + (REL9 <<1) => PC

--- Compiler alias to the command **BCC REL9**

Branch instruction to compare unsigned numbers.

Example:

```

                                ; Branch if RS1 GTE RS2
SUB    R0, R1, R2    ;
BHI    REL9
    
```

CCR Effect:

N	Z	V	C
-	-	-	-

N: Not affected.

Z: Not affected.

V: Not affected.

C: Not affected.

Code and Cycles

ASM Code	Address Mode	Machine Code								Cycles
BHS REL9	REL9	0	0	1	0	0	0	0	REL9	PP/P

BITH – Bit Test Immediate 8 Bit Constant high byte

Function:

RD.H & IMM8 => None

Performs a bit wise logical AND operation between the IMM8 and the high byte of the RD register. Used to detect Set bits in the RD register. RD is not changed and only the condition bits are updated after the instruction is completed.

Example:

```

                                ; --- Test the high byte of R6
    BITH  R6, #HIGHBYTE        ; R6 = R6
    
```

CCR Effect:

N	Z	V	C
Δ	Δ	0	-

N: Set if bit 15 of the result is set, otherwise cleared.

Z: Set if the 8 bit result is \$00, otherwise cleared.

V: Always set to zero.

C: Not affected.

Code and Cycles

ASM Code	Address Mode	Machine Code						Cycles	
BITH RD,#IMM8	IMM8	1	0	0	1	1	RD	IMM8	P

BITL – Bit Test Immediate 8 Bit Constant low byte

Function:

RD.L & IMM8 => None

Performs a bit wise logical AND operation between the IMM8 and the low byte of the RD register. Used to detect set bits in the RD register. RD is not changed and only the condition bits are updated after the instruction is completed.

Example:

```

                                ; --- Test the low byte of R6
    BITL  R6, #LOWBYTE          ; R6 = R6
    
```

CCR Effect:

N	Z	V	C
Δ	Δ	0	-

N: Set if bit 15 of the result is set, otherwise cleared.

Z: Set if the 8 bit result is \$00, otherwise cleared.

V: Always set to zero.

C: Not affected.

Code and Cycles

ASM Code	Address Mode	Machine Code						Cycles	
BITL RD,#IMM8	IMM8	1	0	0	1	0	RD	IMM8	P

BLE – Branch if Less or Equal Zero

Function:

If $Z \mid (N \wedge V) = 1$ then $PC + \$0002 + (REL9 \ll 1) \Rightarrow PC$

Branch instruction to compare signed numbers.

Example:

```

                                ; Branch if RS1 LTE RS2
SUB    R0, R1, R2    ;
BLE    REL9
    
```

CCR Effect:

N	Z	V	C
-	-	-	-

N: Not affected.

Z: Not affected.

V: Not affected.

C: Not affected.

Code and Cycles

ASM Code	Address Mode	Machine Code							Cycles	
BLE REL9	REL9	0	0	1	1	1	0	1	REL9	PP/P

BLO – Branch if Less Than

Function:

If C = 1 then PC + \$0002 + (REL9 <<1) => PC

--- Compiler alias to the command **BCS REL9**

Branch instruction to compare unsigned numbers.

Example:

```

                                ; Branch if RS1 LT RS2
SUB    R0, R1, R2 ;
BLO    REL9
    
```

CCR Effect:

N	Z	V	C
-	-	-	-

N: Not affected.

Z: Not affected.

V: Not affected.

C: Not affected.

Code and Cycles

ASM Code	Address Mode	Machine Code								Cycles	
BLO REL9	REL9	0	0	1	0	0	0	0	1	REL9	PP/P

BLS – Branch Lower or Same

Function:

If $C \mid Z = 0$ then $PC + \$0002 + (REL9 \ll 1) \Rightarrow PC$

Branch instruction to compare unsigned numbers.

Example:

```

                                ; Branch if RS1 LTE RS2
SUB    R0, R1, R2    ;
BLS    REL9
    
```

CCR Effect:

N	Z	V	C
-	-	-	-

N: Not affected.

Z: Not affected.

V: Not affected.

C: Not affected.

Code and Cycles

ASM Code	Address Mode	Machine Code							Cycles	
BLS REL9	REL9	0	0	1	1	0	0	1	REL9	PP/P

BLT – Branch Lower Than Zero

Function:

If $N \wedge V = 1$ then $PC + \$0002 + (REL9 \ll 1) \Rightarrow PC$

Branch instruction to compare signed numbers.

Example:

```

                                ; Branch if RS1 LT RS2
SUB    R0, R1, R2    ;
BLS    REL9
    
```

CCR Effect:

N	Z	V	C
-	-	-	-

N: Not affected.

Z: Not affected.

V: Not affected.

C: Not affected.

Code and Cycles

ASM Code	Address Mode	Machine Code							Cycles	
BLT REL9	REL9	0	0	1	1	0	1	1	REL9	PP/P

BMI – Branch if Minus

Function:

If N = 1 then PC + \$0002 + (REL9 <<1) => PC

Tests the Sign Flag and branch if N = 1.

Example:

```

                                ; Branch if RS1 is Negative
SUB    R0, R1, R0 ;
BMI    REL9
    
```

CCR Effect:

N	Z	V	C
-	-	-	-

N: Not affected.

Z: Not affected.

V: Not affected.

C: Not affected.

Code and Cycles

ASM Code	Address Mode	Machine Code								Cycles
BMI REL9	REL9	0	0	1	0	1	0	1	REL9	PP/P

BNE – Branch if Not Equal

Function:

If $Z = 0$ then $PC + \$0002 + (REL9 \ll 1) \Rightarrow PC$

Tests the Zero Flag and branch if $Z = 0$.

Example:

```

                                ; Branch if RS1 NE RS2
SUB    R0, R1, R2    ;
BNE    REL9
    
```

CCR Effect:

N	Z	V	C
-	-	-	-

N: Not affected.

Z: Not affected.

V: Not affected.

C: Not affected.

Code and Cycles

ASM Code	Address Mode	Machine Code								Cycles	
BNE REL9	REL9	0	0	1	0	0	0	0	1	REL9	PP/P

BPL – Branch if Plus

Function:

If $N = 0$ then $PC + \$0002 + (REL9 \ll 1) \Rightarrow PC$

Tests the Sign Flag and branch if $N = 0$.

Example:

```

                                ; Branch if RS1 Postive
    ADD    R0, R1, R0    ;
    BLS    REL9
    
```

CCR Effect:

N	Z	V	C
-	-	-	-

N: Not affected.

Z: Not affected.

V: Not affected.

C: Not affected.

Code and Cycles

ASM Code	Address Mode	Machine Code								Cycles
BPL REL9	REL9	0	0	1	0	1	0	0	REL9	PP/P

BRA – Branch Always

Function:

$PC + \$0002 + (REL10 \ll 1) \Rightarrow PC$

Branch unconditionally.

Example:

BRA REL10

CCR Effect:

N	Z	V	C
-	-	-	-

N: Not affected.

Z: Not affected.

V: Not affected.

C: Not affected.

Code and Cycles

ASM Code	Address Mode	Machine Code						Cycles	
BRA REL10	REL10	0	0	1	1	1	1	REL10	PP

BRK – Break

Function:

Put Xgate into Debug Mode.

Example:

```
BRK ; Goto debug mode and stop instruction execution
```

CCR Effect:

N	Z	V	C
-	-	-	-

N: Not affected.

Z: Not affected.

V: Not affected.

C: Not affected.

Code and Cycles

ASM Code	Address Mode	Machine Code														Cycles		
BRK	INH	0	0	0	0	0	0	0	0	0	0	0	0	0	0	0	0	PAff

BVC – Branch if Overflow Cleared

Function:

If $V = 0$ then $PC + \$0002 + (REL9 \ll 1) \Rightarrow PC$

Tests the Overflow Flag and branch if $V = 0$.

Example:

```

                                ; Branch if RS1 LTE RS2
SUB    R0, R1, R2 ;
BLS    REL9
    
```

CCR Effect:

N	Z	V	C
-	-	-	-

N: Not affected.

Z: Not affected.

V: Not affected.

C: Not affected.

Code and Cycles

ASM Code	Address Mode	Machine Code								Cycles
BVC REL9	REL9	0	0	1	0	1	1	0	REL9	PP/P

BVS – Branch if Overflow Set

Function:

If $V = 1$ then $PC + \$0002 + (REL9 \ll 1) \Rightarrow PC$

Tests the Overflow Flag and branch if $V = 1$.

Example:

```

                                ; Branch if RS1 LTE RS2
SUB    R0, R1, R2    ;
BLS    REL9
    
```

CCR Effect:

N	Z	V	C
-	-	-	-

N: Not affected.

Z: Not affected.

V: Not affected.

C: Not affected.

Code and Cycles

ASM Code	Address Mode	Machine Code							Cycles	
BVS REL9	REL9	0	0	1	0	1	1	1	REL9	PP/P

CMP – Compare

Function:

RS1 - RS2 => None

--- Compiler alias to the command **SUB R0, RS1 RS2**

Subtract the contents of RS2 from RS1 using binary subtraction and update the condition code registers.

Example:

```

                                ; Do 32 bit addition R7:R6 = R5:R4 + R3:R2
                                ; --- Add least significant 16 bit words
ADD   R6, R4, R2                ; R6 = R4 + R2
                                ; --- Add most significant 16 bit words
ADC   R7, R5, R3                ; R7 = R5 + R3 + C
    
```

CCR Effect:

N	Z	V	C
Δ	Δ	Δ	Δ

N: Set if bit 15 of the result is set, otherwise cleared.

Z: Set if the result register, RD, is all zero's, otherwise cleared.

V: Set if there is a two's complement overflow, otherwise cleared.

$$(RS1[15] \& \sim RS2[15] \& \sim RD[15]_{new}) \mid (\sim RS1[15] \& RS2[15] \& RD[15]_{new})$$

C: Set if there is a carry from bit 15 of the result, otherwise cleared.

$$(\sim RS1[15] \& RS2[15]) \mid (\sim RS1[15] \& RD[15]_{new}) \mid (RS2[15] \& RD[15]_{new})$$

Code and Cycles

ASM Code	Address Mode	Machine Code												Cycles
CMP RS1,RS2	TRI	0	0	0	1	1	0	0	0	RS1	RS2	0	0	P

CMPL – Compare Immediate 8 Bit Constant Low Byte

Function:

RS.L – IMM8 => None

Subtract the IMM8 value from the low byte of RS using binary subtraction and update the condition code registers.

Example:

```

; Do 32 bit addition R7:R6 = R5:R4 + R3:R2
; --- Add least significant 16 bit words
ADD    R6, R4, R2 ; R6 = R4 + R2
; --- Add most significant 16 bit words
ADC    R7, R5, R3 ; R7 = R5 + R3 + C
    
```

CCR Effect:

N	Z	V	C
Δ	Δ	Δ	Δ

N: Set if bit 7 of the result is set, otherwise cleared.

Z: Set if the 8 bit result is all zero's, otherwise cleared.

V: Set if there is a two's complement overflow, otherwise cleared.

$$(RS[7] \& \sim IMM8[7] \& \sim result[7]) \mid (\sim RS[7] \& IMM8[7] \& result[15])$$

C: Set if there is a carry from bit 15 of the result, otherwise cleared.

$$(\sim RS[7] \& RS2[7]) \mid (\sim RS[7] \& result[7]_{new}) \mid (RS[7] \& result[7])$$

Code and Cycles

ASM Code	Address Mode	Machine Code						Cycles	
CMPL RS,#IMM8	IMM8	1	1	0	1	0	RS	IMM8	P

COM – One’s Complement

Function:

\sim RS => RD

\sim RD => RD

--- Compiler alias to the command XNOR RD, R0 RS

--- Compiler alias to the command XNOR RD, R0 RD

Do the one’s complement(bit wise invert) on the RS and store the result in the RD register..

Example:

```

COM   R6, R4,      ; R6 = ~R4
COM   R7           ; R7 = ~R7
    
```

CCR Effect:

N	Z	V	C
Δ	Δ	0	-

N: Set if bit 15 of the result is set, otherwise cleared.

Z: Set if the result is all zero’s, otherwise cleared.

V: Always cleared.

C: Not affected.

Code and Cycles

ASM Code	Address Mode	Machine Code										Cycles		
		0	0	0	1	0	RD	0	0	0	RS		1	1
COM RD,RS	TRI	0	0	0	1	0	RD	0	0	0	RS	1	1	P
COM RD	TRI	0	0	0	1	0	RD	0	0	0	RD	1	1	P

CPC – Compare with Carry

Function:

RS1 - RS2 – C => RD

--- Compiler alias to the command **SBC RD, RS1 RS2**

Subtract the Carry bit and the contents of RS2 from RS1 using binary subtraction, and update the condition code registers.

Example:

```

                                ; Do 32 bit addition R7:R6 = R5:R4 + R3:R2
                                ; --- Add least significant 16 bit words
ADD    R6, R4, R2                ; R6 = R4 + R2
                                ; --- Add most significant 16 bit words
ADC    R7, R5, R3                ; R7 = R5 + R3 + C
    
```

CCR Effect:

N	Z	V	C
Δ	Δ	Δ	Δ

N: Set if bit 15 of the result is set, otherwise cleared.

Z: Set if the result register, RD, is all zero's, otherwise cleared.

V: Set if there is a two's complement overflow, otherwise cleared.

$$(RS1[15] \& \sim RS2[15] \& \sim result[15]) \mid (\sim RS1[15] \& RS2[15] \& result[15])$$

C: Set if there is a carry from bit 15 of the result, otherwise cleared.

$$(\sim RS1[15] \& RS2[15]) \mid (\sim RS1[15] \& result[15]) \mid (RS2[15] \& result[15])$$

Code and Cycles

ASM Code	Address Mode	Machine Code												Cycles
SPC RS1,RS2	TRI	0	0	0	1	1	0	0	0	RS1	RS2	0	1	P

CPCH – Compare Immediate with bit constant with Carry high byte

Function:

RS.H – IMM8 - C => None

Subtract the contents of RS2 from RS1 using binary subtraction and update the condition code registers.

Example:

```

                                ; Do 16 bit compare of constant to R2
    CMPL R6, #LOWBYTE           ; Update Condition Code Register
    CMPH R6, #HIGHBYTE         ; Update Condition Code Register
    BCS  IS_EQUAL
    
```

CCR Effect:

N	Z	V	C
Δ	Δ	Δ	Δ

N: Set if bit 15 of the result is set, otherwise cleared.

Z: Set if the result is all \$00 and Z was set before this instruction, otherwise cleared.

V: Set if there is a two's complement overflow, otherwise cleared.

$$(RS[15] \& \sim IMM8[7] \& \sim result[15]) \mid (\sim RS[15] \& IMM8[7] \& result[15])$$

C: Set if there is a carry from bit 15 of the result, otherwise cleared.

$$(\sim RS[15] \& IMM8[7]) \mid (\sim RS1[15] \& result[15]) \mid (IMM8[7] \& result[15])$$

Code and Cycles

ASM Code	Address Mode	Machine Code						Cycles	
		1	1	0	1	1	RS		IMM8
CPCH RS,#IMM8	TRI	1	1	0	1	1	RS	IMM8	P

CSEM – Clear Semaphore Bit

Function:

0 => XGSEM[IMM3]

0 => XGSEM[RD[2:0]]

Unlocks a semaphore bit that was set by the RISC core.

Example:

```

                                ; Do 32 bit addition R7:R6 = R5:R4 + R3:R2
                                ; --- Add least significant 16 bit words
    ADD    R6, R4, R2           ; R6 = R4 + R2
                                ; --- Add most significant 16 bit words
    ADC    R7, R5, R3           ; R7 = R5 + R3 + C
    
```

CCR Effect:

N	Z	V	C
-	-	-	-

N: Not affected.

Z: Not affected.

V: Not affected.

C: Not affected.

Code and Cycles

ASM Code	Address Mode	Machine Code												Cycles			
		0	0	0	0	0	0	IMM3	1	1	1	1	0		0	0	0
CSEM #IMM3	IMM3	0	0	0	0	0	0	IMM3	1	1	1	1	0	0	0	0	P
CSEM RS	MON	0	0	0	0	0	0	RS	1	1	1	1	0	0	0	1	P

CSL – Logical Shift Left with Carry

Function:

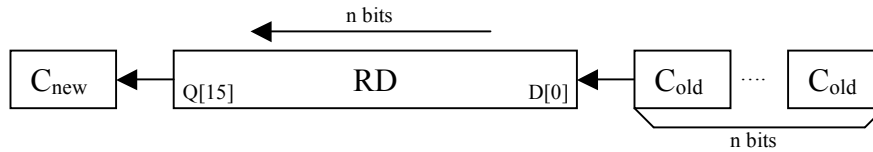

$n = \text{RS or IMM4}; 0 \leq n \leq 16$

Left shift the contents of the RD register n positions. The lower n bits of RD are filled with the contents of the carry register. At the end of the operation the carry register will be updated with the contents of RD[16- n] when n is greater than zero.

Example:

```

; Do 16 bit compare of constant to R2
CMPL R6, #LOWBYTE      ; Update Condition Code Register
CMPH R6, #HIGHBYTE     ; Update Condition Code Register
BCS  IS_EQUAL
    
```

CCR Effect:

N	Z	V	C
Δ	Δ	Δ	Δ

N: Set if bit 15 of the result is set, otherwise cleared.

Z: Set if the result is \$0000, otherwise cleared.

V: Set if there is a two’s complement overflow, otherwise cleared.

$$RD[15]_{old} \wedge RD[15]_{new}$$

C: Set if ($n > 0$) and $RD[16-n] = 1$. If ($n = 0$) then there is no change in C.

Code and Cycles

ASM Code	Address Mode	Machine Code										Cycles		
CSL RD,#IMM4	IMM4	0	0	0	0	1	RD	IMM4	1	0	1	0	P	
CSL RD,RS	DYA	0	0	0	0	1	RD	RS	1	0	0	1	0	P

CSR – Logical Shift Right with Carry

Function:

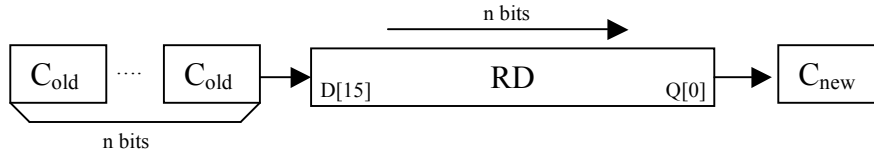

$n = RS \text{ or } IMM4; 0 \leq n \leq 16.$

Example:

```

; Do 16 bit compare of constant to R2
CMPL R6, #LOWBYTE      ; Update Condition Code Register
CMPH R6, #HIGHBYTE    ; Update Condition Code Register
BCS  IS_EQUAL
    
```

CCR Effect:

N	Z	V	C
Δ	Δ	Δ	Δ

N: Set if bit 15 of the result is set, otherwise cleared.

Z: Set if the result is \$0000, otherwise cleared.

V: Set if there is a two’s complement overflow, otherwise cleared.

$$RD[15]_{old} \wedge RD[15]_{new}$$

C: Set if $(n > 0)$ and $RD[n-1] = 1$. If $(n = 0)$ then there is no change in C.

Code and Cycles

ASM Code	Address Mode	Machine Code										Cycles		
		0	0	0	0	1	RD	IMM4	1	0	1		1	
CSR RD,#IMM4	IMM4	0	0	0	0	1	RD	IMM4	1	0	1	1	P	
CSR RD,RS	DYA	0	0	0	0	1	RD	RS	1	0	0	1	1	P

JAL – Jump and LINK

Function:

PC + \$0002 => RD; RD => PC

Branches to the address in RD and stores the return address to RD.

Example:

```

TFR    R5, PC        ; Save the return address in R5
BRA    SUB_1         ; Goto the subroutine code
; More Code
SUB_1
; Subroutine Code
JAL    RD            ; Return to the address after the BRA
    
```

CCR Effect:

N	Z	V	C
-	-	-	-

N: Not affected.

Z: Not affected.

V: Not affected.

C: Not affected.

Code and Cycles

ASM Code	Address Mode	Machine Code												Cycles		
JAL RD	IMM4	0	0	0	0	0	RD	1	1	1	1	0	1	1	0	PP

LDB – Load Byte From Memory Low Byte

Function:

$M[RB, \$OFFS5] \Rightarrow RD.L; \$00 \Rightarrow RD.H$ ($\$OFFS5$ = unsigned offset)
 $M[RB, RI] \Rightarrow RD.L; \$00 \Rightarrow RD.H$
 $M[RB, RI+] \Rightarrow RD.L; \$00 \Rightarrow RD.H; RI + 1 \Rightarrow RI$ (Post increment)
 $RI - 1 \Rightarrow RI; M[RS, -RI] \Rightarrow RD.L; \$00 \Rightarrow RD.H$ (Pre decrement)

Loads the low byte of RD from memory and clear the high byte of RD.

Example:

```
TFR    R5, PC    ; Save the return address in R5
```

CCR Effect:

N	Z	V	C
-	-	-	-

N: Not affected.

Z: Not affected.

V: Not affected.

C: Not affected.

Code and Cycles

ASM Code	Address Mode	Machine Code								Cycles		
		0	1	0	0	0	RD	RB	OFFS5			
LDB RD, (RB, #IMM8)	IDO5	0	1	0	0	0	RD	RB	OFFS5	PR		
LDB RD, (RS, RI)	IDR	0	1	1	0	0	RD	RB	RI	0	0	PR
LDB RD, (RS, RI+) ¹	IDR+	0	1	1	0	0	RD	RB	RI	0	1	PR
LDB RD, (RS, -RI)	-IDR	0	1	1	0	0	RD	RB	RI	1	0	PR

Note:

If the $RB == RD$ the final value of RD will be $M[RB,RI]$; RD will not be incremented.

LDH – Load Immediate 8 Bit Constant High Byte

Function:

IMM8 => RD.H

Put an 8 bit constant into the high byte of the RD register. The low byte of RD is unaffected.

Example:

```
LDL  R5, $55      ; R5 = $0055
LDH  R5, $AA      ; R5 = $AA55
```

CCR Effect:

N	Z	V	C
-	-	-	-

N: Not affected.

Z: Not affected.

V: Not affected.

C: Not affected.

Code and Cycles

ASM Code	Address Mode	Machine Code						Cycles	
LDH #IMM8	IMM8	1	1	1	1	1	RD	IMM8	P

LDL – Load Immediate 8 Bit Constant Low Byte

Function:

IMM8 => RD.L; \$00 => RD.H

Put an 8 bit constant into the low byte of the RD register. The high byte of RD is set to \$00.

Example:

```
LDL  R5, $55      ; R5 = $0055
LDH  R5, $AA      ; R5 = $AA55
```

CCR Effect:

N	Z	V	C
-	-	-	-

N: Not affected.

Z: Not affected.

V: Not affected.

C: Not affected.

Code and Cycles

ASM Code	Address Mode	Machine Code						Cycles	
		1	1	1	1	0	RD		IMM8
LDL #IMM8	IMM8	1	1	1	1	0	RD	IMM8	P

LDW – Load Word From Memory

Function:

$M[RB, \$OFFS5] \Rightarrow RD$

$M[RB, RI] \Rightarrow RD$

$M[RB, RI+] \Rightarrow RD; RI + 2 \Rightarrow RI$ (Post increment)

$M[RS, -RI] \Rightarrow RD; RI - 2 \Rightarrow RI$ (Pre decrement)

Loads the of RD register from memory.

Example:

```
TFR    R5, PC    ; Save the return address in R5
```

CCR Effect:

N	Z	V	C
-	-	-	-

N: Not affected.

Z: Not affected.

V: Not affected.

C: Not affected.

Code and Cycles

ASM Code	Address Mode	Machine Code								Cycles		
		0	1	0	0	1	RD	RB	OFFS5			
LDW RD, (RB, #IMM8)	IDO5	0	1	0	0	1	RD	RB	OFFS5	PR		
LDW RD, (RS, RI)	IDR	0	1	1	0	1	RD	RB	RI	0	0	PR
LDW RD, (RS, RI+) ¹	IDR+	0	1	1	0	1	RD	RB	RI	0	1	PR
LDW RD, (RS, -RI)	-IDR	0	1	1	0	1	RD	RB	RI	1	0	PR

Note:

1) If the $RB == RD$ the final value of RD will be $M[RB,RI]$; RD will not be incremented.

LSL – Logical Shift Left

Function:

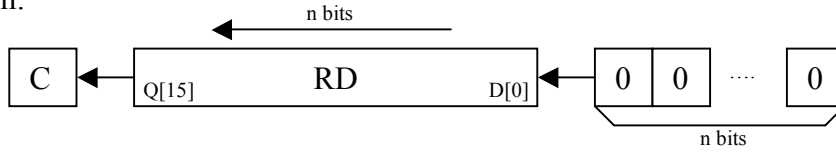

Use binary addition to add RS1, RS2, and Carry and store the sum in the RD register.

Example:

```
ANDL R6, #LOWBYTE ; R6.L = R6.L & 8 bit immediate
```

CCR Effect:

N	Z	V	C
Δ	Δ	Δ	Δ

N: Set if bit 15 of the result is set, otherwise cleared.

Z: Set if the result register, RD, is all zero's, otherwise cleared.

V: .

$RD[15]_{old} \wedge RD[15]_{new}$.

C: Set if $n > 0$ and $RD[16-n] = 1$, if $n = 0$ then unaffected.

Code and Cycles

ASM Code	Address Mode	Machine Code										Cycles		
LSL RD,#IMM4	IMM4	0	0	0	0	1	RD	IMM4	1	1	0	0	P	
LSL RD,RS	DYA	0	0	0	0	1	RD	RS	1	0	1	0	0	P

LSR – Logical Shift Right

Function:

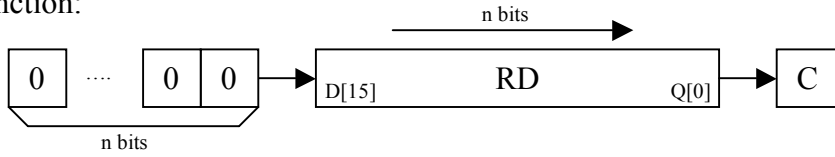

Use binary addition to add RS1, RS2, and Carry and store the sum in the RD register.

Example:

```
ANDL R6, #LOWBYTE ; R6.L = R6.L & 8 bit immediate
```

CCR Effect:

N	Z	V	C
Δ	Δ	Δ	Δ

N: Set if bit 15 of the result is set, otherwise cleared.

Z: Set if the result register, RD, is all zero's, otherwise cleared.

V: Set if RD[15] changed.

$RD[15]_{old} \wedge RD[15]_{new}$.

C: Set if $n > 0$ and $RD[16-n] = 1$, if $n = 0$ then unaffected.

Code and Cycles

ASM Code	Address Mode	Machine Code										Cycles		
LSR RD,#IMM4	IMM4	0	0	0	0	1	RD	IMM4	1	1	0	1	P	
LSR RD,RS	DYA	0	0	0	0	1	RD	RS	1	0	1	0	1	P

MOV – Move Register Content

Function:

RS => RD

--- Compiler alias to the command OR RD, R0 RS

Copies the contents of the RS register to the RD register.

Example:

```
MOV    R6, R4    ; R6 = R4
```

CCR Effect:

N	Z	V	C
Δ	Δ	0	-

N: Set if bit 15 of the result is set, otherwise cleared.

Z: Set if the result register, RD, is all zero's, otherwise cleared.

V: Always cleared.

C: Not affected

Code and Cycles

ASM Code	Address Mode	Machine Code										Cycles		
MOV RD,RS	TRI	0	0	0	1	0	RD	0	0	0	RS2	1	0	P

NEG – Two’s Complement

Function:

-RS => RD

-RD => RD

--- Compiler alias to the command SUB RD, R0 RS

--- Compiler alias to the command SUB RD, R0 RD

Calculate the two’s complement of a general purpose register.

Example:

```

NEG   R6, R4      ; R6 = -R4
NEG   R7          ; R7 = -R7
    
```

CCR Effect:

N	Z	V	C
Δ	Δ	Δ	Δ

N: Set if bit 15 of the result is set, otherwise cleared.

Z: Set if the result register, RD, is all zero’s, otherwise cleared.

V: Set if there is a two’s complement overflow, otherwise cleared.

$$(RS1[15] \& \sim RS2[15] \& \sim RD[15]_{new}) \mid (\sim RS1[15] \& RS2[15] \& RD[15]_{new})$$

C: Set if there is a carry from bit 15 of the result, otherwise cleared.

$$(\sim RS1[15] \& RS2[15]) \mid (\sim RS1[15] \& RD[15]_{new}) \mid (RS2[15] \& RD[15]_{new})$$

Code and Cycles

ASM Code	Address Mode	Machine Code										Cycles		
		0	0	0	1	1	RD	0	0	0	RS		0	0
NEG RD, RS	TRI	0	0	0	1	1	RD	0	0	0	RS	0	0	P
NEG RD	TRI	0	0	0	1	1	RD	0	0	0	RD	0	0	P

NOP – No Operation

Function:

PC + \$0002 => PC

Consume one cycle of RISC CPU time without doing anything.

Example:

```
NOP          ; Stall for one CPU cycle
```

CCR Effect:

N	Z	V	C
-	-	-	-

N: Not affected.

Z: Not affected.

V: Not affected.

C: Not affected.

Code and Cycles

ASM Code	Address Mode	Machine Code	Cycles
NOP	INH	0 0 0 0 0 0 0 0 1 0 0 0 0 0 0 0 0	P

OR – Logical OR

Function:

RS1 | RS2 => RD

Do a bit wise logical OR operation between the RS1 register and the RS2 register and put the result in the RD register.

Example:

```

                                ; Do 16 bit logical OR
OR    R6, R4, R2    ; R6 = R4 | R2
OR    R6, R0, R4    ; R6 = R4
    
```

CCR Effect:

N	Z	V	C
Δ	Δ	0	-

N: Set if bit 15 of the result is set, otherwise cleared.

Z: Set if the result register, RD, is all zero's, otherwise cleared.

V: Always cleared.

C: Not affected

Code and Cycles

ASM Code	Address Mode	Machine Code						Cycles				
OR RD,RS1,RS2	TRI	0	0	0	1	0	RD	RS1	RS2	1	0	P

ORH – Logical OR 8 Bit Immediate Constant High Byte

Function:

RD.H | IMM8 => RD.H

Do a bit wise logical OR operation between the 8 bit immediate value and the RD high byte and put the result in the RD high byte register.

Example:

```

ORH    R6, #$AA    ; Do 8 bit logical OR
                    ; R6 = R6 | $AA00
    
```

CCR Effect:

N	Z	V	C
Δ	Δ	0	-

N: Set if bit 15 of the result is set, otherwise cleared.

Z: Set if the 8 bit result is \$00, otherwise cleared.

V: Always cleared.

C: Not affected

Code and Cycles

ASM Code	Address Mode	Machine Code						Cycles	
ORH RD,#IMM8	IMM8	1	0	1	0	1	RD	IMM8	P

ORL – Logical OR 8 Bit Immediate Constant Low Byte

Function:

$RD.H \mid IMM8 \Rightarrow RD.H$

Do a bit wise logical OR operation between the 8 bit immediate value and the RD low byte and put the result in the RD low byte register.

Example:

```

                                ; Do 8 bit logical OR
    ORL    R6, #$AA             ; R6 = R6 | $0055
    
```

CCR Effect:

N	Z	V	C
Δ	Δ	0	-

N: Set if bit 15 of the result is set, otherwise cleared.

Z: Set if the 8 bit result is \$00, otherwise cleared.

V: Always cleared.

C: Not affected

Code and Cycles

ASM Code	Address Mode	Machine Code						Cycles	
ORL RD,#IMM8	IMM8	1	0	1	0	0	RD	IMM8	P

PAR – Calculate Parity

Function:

RD.H | IMM8 => RD.H

Set the Carry flag if the number of one's in the RD register is odd..

Example:

```

                                ; Do 16 bit parity
PAR    R6    ; R6 = R6; Carry = Odd or Even
    
```

CCR Effect:

N	Z	V	C
Δ	Δ	0	Δ

N: Set if bit 15 of the result is set, otherwise cleared.

Z: Set if the RD is \$0000, otherwise cleared.

V: Always cleared.

C: Set if RD has an odd number of 1's, otherwise cleared.

Code and Cycles

ASM Code	Address Mode	Machine Code												Cycles		
PAR RD	IMM8	0	0	0	0	0	RD	1	1	1	1	0	1	0	1	P

ROL – Rotate Left

Function:

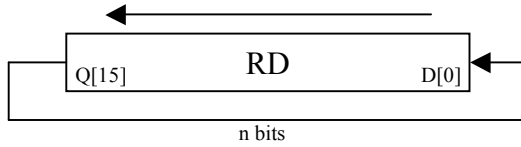

n = RS or IMM4.

Set the Carry flag if the number of one’s in the RD register is odd..

Example:

```

; Do 16 bit parity
PAR R6 ; R6 = R6; Carry = Odd or Even
    
```

CCR Effect:

N	Z	V	C
Δ	Δ	0	-

N: Set if bit 15 of the result is set, otherwise cleared.

Z: Set if the RD is \$0000, otherwise cleared.

V: Always cleared.

C: No affected.

Code and Cycles

ASM Code	Address Mode	Machine Code										Cycles		
		0	0	0	0	1	RD	IMM4	1	1	1		0	
ROL RD, #IMM4	IMM4	0	0	0	0	1	RD	IMM4	1	1	1	0	P	
ROL RD, RS	DYA	0	0	0	0	1	RD	RS	1	0	1	1	0	P

ROR – Rotate Right

Function:

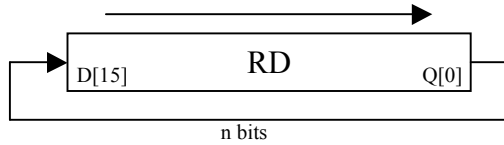

n = RS or IMM4.

Example:

```
ROR R6, #3 ; R6 = R6 ROR 3 places
```

CCR Effect:

N	Z	V	C
Δ	Δ	0	-

N: Set if bit 15 of the result is set, otherwise cleared.

Z: Set if the RD is \$0000, otherwise cleared.

V: Always cleared.

C: No affected.

Code and Cycles

ASM Code	Address Mode	Machine Code										Cycles		
		0	0	0	0	1	RD	IMM4	1	1	1		1	
ROR RD, #IMM4	IMM4	0	0	0	0	1	RD	IMM4	1	1	1	1	P	
ROR RD, RS	DYA	0	0	0	0	1	RD	RS	1	0	1	1	1	P

RTS – Return to Scheduler

Function:

Completes the current thread of program instructions and remain idle till the hardware scheduler starts a new thread.

Example:

```

        RTS          ;
                ; Channel thread complete
    
```

CCR Effect:

N	Z	V	C
-	-	-	-

N: Not affected.

Z: Not affected.

V: Not affected.

C: Not affected.

Code and Cycles

ASM Code	Address Mode	Machine Code														Cycles			
RTS	INH	0	0	0	0	0	0	0	1	0	0	0	0	0	0	0	0	0	P

SBC – Subtract with Carry

Function:

$RS1 - RS2 - C \Rightarrow RD$

Subtract the Carry bit and the contents of RS2 from RS1 using binary subtraction, store the result in RD and update the condition code registers.

Example:

```

; Do 32 bit subtraction R7:R6 = R5:R4 - R3:R2
; --- Subtract least significant 16 bit words
SUB  R6, R4, R2 ; R6 = R4 - R2
; --- Subtract most significant 16 bit words
SBC  R7, R5, R3 ; R7 = R5 - R3 - C
    
```

CCR Effect:

N	Z	V	C
Δ	Δ	Δ	Δ

N: Set if bit 15 of the result is set, otherwise cleared.

Z: Set if the result register, RD, is all zero's and Z was set before the operation, otherwise cleared.

V: Set if there is a two's complement overflow, otherwise cleared.

$$(RS1[15] \& \sim RS2[15] \& \sim RD[15]_{new}) \mid (\sim RS1[15] \& RS2[15] \& RD[15]_{new})$$

C: Set if there is a carry from bit 15 of the result, otherwise cleared.

$$(\sim RS1[15] \& RS2[15]) \mid (\sim RS1[15] \& RD[15]_{new}) \mid (RS2[15] \& RD[15]_{new})$$

Code and Cycles

ASM Code	Address Mode	Machine Code										Cycles
SBC RD,RS1,RS2	TRI	0	0	0	1	1	RD	RS1	RS2	0	0	P

SSEM – Set Semaphore Bit

Function:

1 => XGSEM[IMM3]

1 => XGSEM[RD[2:0]]

Locks a semaphore bit that was set by the RISC core.

Example:

```

NOT_MINE
    SSEM  R6           ; Attempt to set semaphore bit
    BCC   NOT_MINE    ; --- Wait till RISC has semaphore bit
    SSEM  #3          ; Attempt to set semaphore bit 3
    
```

CCR Effect:

N	Z	V	C
-	-	-	Δ

N: Not affected.

Z: Not affected.

V: Not affected.

C: Set if semaphore is locked by RISC core.

Code and Cycles

ASM Code	Address Mode	Machine Code														Cycles	
		0	0	0	0	0	0	IMM3	1	1	1	1	0	0	1		0
SSEM #IMM3	IMM3	0	0	0	0	0	0	IMM3	1	1	1	1	0	0	1	0	P
SSEM RS	MON	0	0	0	0	0	0	RS	1	1	1	1	0	0	1	1	P

SEX – Sign Extend

Function:

RD.L => RD

The 8 bit two's complement number stored in RD.L is sign extended to fill the RD register.

Example:

```
SEX   R6           ; --- Add 8 bit number to 16 bit number
ADD   R7, R6, R3  ; R7 = R6 + R3
```

CCR Effect:

N	Z	V	C
Δ	Δ	0	-

N: Set if bit 15 of the result is set, otherwise cleared.

Z: Set if the result register, RD, is all zero's, otherwise cleared.

V: Always cleared.

C: Not affected.

Code and Cycles

ASM Code	Address Mode	Machine Code												Cycles		
SEX RD	MON	0	0	0	0	0	RD	1	1	1	1	0	1	0	0	P

SIF – Set Interrupt Flag

Function:

1 => XGIF[XGCHID]

1 => XGIF[RS[6:0]]

Set the output interrupt flag.

Example:

```

SIF  R6      ; Signal Host to release semaphore register?
SIF                    ; Signal Host that thread is complete
RTS                    ; Allow Xgate to accept new input interrupt
    
```

CCR Effect:

N	Z	V	C
-	-	-	-

N: Not affected.

Z: Not affected.

V: Not affected.

C: Not affected.

Code and Cycles

ASM Code	Address Mode	Machine Code														Cycles		
SIF	INH	0	0	0	0	0	0	0	1	1	0	0	0	0	0	0	0	
SIF RS	MON	0	0	0	0	0	RS	1	1	1	1	0	1	1	1		P	

STB – Store Byte To Memory Low Byte

Function:

```

RS.L      M[RB, $OFFS5]
RS.L      M[RB, RI]
RS.L      M[RB, +RI]; RI + 1 => RI
RS.L      M[RS, -RI]; RI - 1 => RI
    
```

Stores the low byte of register RS to memory.

Example:

```

TFR      R5, PC      ; Save the return address in R5
    
```

CCR Effect:

N	Z	V	C
-	-	-	-

N: Not affected.

Z: Not affected.

V: Not affected.

C: Not affected.

Code and Cycles

ASM Code	Address Mode	Machine Code								Cycles		
		0	1	0	1	0	RD	RB	OFFS5			
STB RD, (RB, #IMM8)	IDO5	0	1	0	1	0	RD	RB	OFFS5	PR		
STB RD, (RS, RI)	IDR	0	1	1	1	0	RD	RB	RI	0	0	PR
STB RD, (RS, RI+)	IDR+	0	1	1	1	0	RD	RB	RI	0	1	PR
STB RD, (RS, -RI)	-IDR	0	1	1	1	0	RD	RB	RI	1	0	PR

STW – Store Word To Memory

Function:

RS ⇒ M[RB, \$OFFS5]

RS ⇒ M[RB, RI]

RS ⇒ M[RB, +RI]; RI + 2 ⇒ RI

RS ⇒ M[RS, -RI]; RI – 2 ⇒ RI

Stores the contents of the RD register to memory.

Example:

```
TFR    R5, PC    ; Save the return address in R5
```

CCR Effect:

N	Z	V	C
-	-	-	-

N: Not affected.

Z: Not affected.

V: Not affected.

C: Not affected.

Code and Cycles

ASM Code	Address Mode	Machine Code									Cycles	
		0	1	0	1	1	RD	RB	OFFS5			
STW RD, (RB, #IMM8)	IDO5	0	1	0	1	1	RD	RB	OFFS5			PR
STW RD, (RS, RI)	IDR	0	1	1	1	1	RD	RB	RI	0	0	PR
STW RD, (RS, RI+)	IDR+	0	1	1	1	1	RD	RB	RI	0	1	PR
STW RD, (RS, -RI)	-IDR	0	1	1	1	1	RD	RB	RI	1	0	PR

SUB – Subtract without Carry

Function:

RS1 - RS2 => RD

Subtract the contents of RS2 from RS1 using binary subtraction, store the result in RD and update the condition code registers.

Example:

```

; Do 32 bit subtraction R7:R6 = R5:R4 - R3:R2
; --- Subtract least significant 16 bit words
SUB  R6, R4, R2 ; R6 = R4 - R2
; --- Subtract most significant 16 bit words
SBC  R7, R5, R3 ; R7 = R5 - R3 - C
    
```

CCR Effect:

N	Z	V	C
Δ	Δ	Δ	Δ

N: Set if bit 15 of the result is set, otherwise cleared.

Z: Set if the result register, RD, is all zero's, otherwise cleared.

V: Set if there is a two's complement overflow, otherwise cleared.

$$(RS1[15] \& \sim RS2[15] \& \sim RD[15]_{new}) \mid (\sim RS1[15] \& RS2[15] \& RD[15]_{new})$$

C: Set if there is a carry from bit 15 of the result, otherwise cleared.

$$(\sim RS1[15] \& RS2[15]) \mid (\sim RS1[15] \& RD[15]_{new}) \mid (RS2[15] \& RD[15]_{new})$$

Code and Cycles

ASM Code	Address Mode	Machine Code										Cycles
SUB RD,RS1,RS2	TRI	0	0	0	1	1	RD	RS1	RS2	0	0	P

SUBH – Subtract Immediate 8-bit constant high byte

Function:

RD - IMM8:\$00 => RD

Subtract a signed 8 bit immediate constant from the high byte of RD and store the result in the high byte of the RD register.

Example:

```

                                ; --- Subtract 16 bit immediate
                                ; R6 = R6 - 8 bit immediate
    SUBL R6, #LOWBYTE
                                ; R6 = R6 - 16 bit immediate
    SUBH R6, #HIGHBYTE
    
```

CCR Effect:

N	Z	V	C
Δ	Δ	Δ	Δ

N: Set if bit 15 of the result is set, otherwise cleared.

Z: Set if the result register, RD, is all zero's, otherwise cleared.

V: Set if there is a two's complement overflow, otherwise cleared.

$$(RD[15]_{old} \& \sim IMM8[7] \& \sim RD[15]_{new}) \mid (\sim RD[15]_{old} \& IMM8[7] \& RD[15]_{new})$$

C: Set if there is a carry from bit 15 of the result, otherwise cleared.

$$(\sim RD[15]_{old} \& IMM8[7] \mid \sim RD[15]_{old} \& RD[15]_{new}) \mid (IMM8[7] \& RD[15]_{new})$$

Code and Cycles

ASM Code	Address Mode	Machine Code						Cycles	
SUBH RD,#IMM8	IMM8	1	1	0	0	1	RD	IMM8	P

SUBL – Subtract Immediate 8-bit constant low byte

Function:

RD - \$00:IMM8 => RD

Subtract an 8 bit immediate constant from the RD register and store the result in the RD register. (All bits in the RD register may be affected by this operation.)

Example:

```

                                ; --- Subtract 16 bit immediate
                                ; R6 = R6 - 8 bit immediate
    SUBL R6, #LOWBYTE
                                ; R6 = R6 - 16 bit immediate
    SUBH R6, #HIGHBYTE
    
```

CCR Effect:

N	Z	V	C
Δ	Δ	Δ	Δ

N: Set if bit 15 of the result is set, otherwise cleared.

Z: Set if the result register, RD, is all zero's, otherwise cleared.

V: Set if there is a two's complement overflow, otherwise cleared.

$$(\sim RD[15]_{old} \& RD[15]_{new})$$

C: Set if there is a carry from bit 7 to bit 8 of the result, otherwise cleared.

$$(\sim RD[7]_{old} \& IMM8[7]) \mid (RD[7] \& \sim RD[7]_{new}) \mid (\sim RD[7]_{new} \& IMM8[7])$$

Code and Cycles

ASM Code	Address Mode	Machine Code						Cycles	
SUBL RD,#IMM8	IMM8	1	1	0	0	0	RD	IMM8	P

TFR – Transfer from and To Special Registers

Function:

TFR RD, CCR: CCR + RD[3:0] => RD; 0 => RD[15:4]

TFR CCR, RD: RD[3:0] => CCR

TFR RD,PC: PC + 4 => RD

Copies the contents of one RISC core register to another RISC core register.

Example:

```

TFR   R5, PC      ; Save the return address in R5
BRA   SUB_1      ; Goto the subroutine code
; More Code
SUB_1
; Subroutine Code
JAL   RD          ; Return to the address after the BRA
    
```

CCR Effect:

N	Z	V	C
-	-	-	-

N: Not affected.

Z: Not affected.

V: Not affected.

C: Not affected.

Code and Cycles

ASM Code	Address Mode	Machine Code												Cycles		
		0	0	0	0	0	RD	1	1	1	1	1	0		0	0
TFR RD,CCR	MON	0	0	0	0	0	RD	1	1	1	1	1	0	0	0	PP
TFR CCR,RS	MON	0	0	0	0	0	RS	1	1	1	1	1	0	0	1	
TFR RD,PC	MON	0	0	0	0	0	RD	1	1	1	1	1	0	1	0	

TST – Test Register

Function:

RS - 0 => None

--- Compiler alias to the command **SUB R0, RS, R0**

Subtract zero from the contents of the RS register and update the condition code registers.

Example:

```
TST    R6
BEQ    IS_ZERO    ; R6 == 0
BMI    IS_NEG     ; R6 is a negative number
```

CCR Effect:

N	Z	V	C
Δ	Δ	Δ	Δ

N: Set if bit 15 of the result is set, otherwise cleared.

Z: Set if the result register, RD, is all zero's, otherwise cleared.

V: Set if there is a two's complement overflow, otherwise cleared.

$$(RS1[15] \& \sim RS2[15] \& \sim RD[15]_{new}) \mid (\sim RS1[15] \& RS2[15] \& RD[15]_{new})$$

C: Set if there is a carry from bit 15 of the result, otherwise cleared.

$$(\sim RS1[15] \& RS2[15]) \mid (\sim RS1[15] \& RD[15]_{new}) \mid (RS2[15] \& RD[15]_{new})$$

Code and Cycles

ASM Code	Address Mode	Machine Code										Cycles				
TST RS	TRI	0	0	0	1	1	0	0	0	RS	0	0	0	0	0	P

XNOR – Logical Exclusive NOR

Function:

$$\sim(\text{RS1} \wedge \text{RS2}) \Rightarrow \text{RD}$$

Do a bit wise logical XNOR between the RS1 register and the RS2 register and store the result in the RD register.

Example:

```
XNOR R6, R0, R6 ; R6 = One's complement (invert) R6
XNOR R6, R0, R0 ; R6 = $FFFF
```

CCR Effect:

N	Z	V	C
Δ	Δ	0	-

N: Set if bit 15 of the result is set, otherwise cleared.

Z: Set if the result register, RD, is all zero's, otherwise cleared.

V: Always cleared.

C: Not affected.

Code and Cycles

ASM Code	Address Mode	Machine Code						Cycles				
XNOR RD,RS1,RS2	TRI	0	0	0	1	0	RD	RS1	RS2	1	1	P

XNORH – Logical Exclusive NOR Constant High Byte

Function:

$\sim(\text{RD.H} \wedge \text{IMM8}) \Rightarrow \text{RD.H}$

Do a bit wise logical XNOR between the 8-bit constant and the high byte of the RD register and store the result in the RD register. The low byte of RD is not affected.

Example:

```
XNOR R6, R0, R6 ; R6 = One's complement (invert) R6
XNOR R6, R0, R0 ; R6 = $FFFF
```

CCR Effect:

N	Z	V	C
Δ	Δ	0	-

N: Set if bit 15 of the result is set, otherwise cleared.

Z: Set if the result register, RD, is all zero's, otherwise cleared.

V: Always cleared.

C: Not affected.

Code and Cycles

ASM Code	Address Mode	Machine Code						Cycles	
XNORH RD,#IMM8	IMM8	1	0	1	1	1	RD	IMM8	P

XNORL – Logical Exclusive NOR Constant Low Byte

Function:

$\sim(\text{RD.L} \wedge \text{IMM8}) \Rightarrow \text{RD.L}$

Do a bit wise logical XNOR between the 8-bit constant and the low byte of the RD register and store the result in the RD register. The high byte of RD is not affected.

Example:

```
XNORL R6, R0, R6 ; R6 = One's complement (invert) R6
XNORL R6, $00    ; R6 = R6[15:8]:$FF
```

CCR Effect:

N	Z	V	C
Δ	Δ	0	-

N: Set if bit 15 of the result is set, otherwise cleared.

Z: Set if the result register, RD, is all zero's, otherwise cleared.

V: Always cleared.

C: Not affected.

Code and Cycles

ASM Code	Address Mode	Machine Code						Cycles	
XNORL RD,#IMM8	IMM8	1	0	1	1	0	RD	IMM8	P

Index

[This section contains an alphabetical list of helpful document entries with their corresponding page numbers.]

Error! No index entries found.